



Full wwPDB EM Validation Report ⓘ

Jun 9, 2024 – 01:42 AM JST

PDB ID : 8IFB
EMDB ID : EMD-35411
Title : Dibekacin-bound E.coli 70S ribosome in the PURE system
Authors : Tomono, J.; Asano, K.; Chiashi, T.; Tanaka, Y.; Yokoyama, T.
Deposited on : 2023-02-17
Resolution : 2.43 Å (reported)

This is a Full wwPDB EM Validation Report for a publicly released PDB entry.

We welcome your comments at validation@mail.wwpdb.org

A user guide is available at

<https://www.wwpdb.org/validation/2017/EMValidationReportHelp>

with specific help available everywhere you see the ⓘ symbol.

The types of validation reports are described at

<http://www.wwpdb.org/validation/2017/FAQs#types>.

The following versions of software and data (see [references ⓘ](#)) were used in the production of this report:

EMDB validation analysis : 0.0.1.dev92
Mogul : 1.8.5 (274361), CSD as541be (2020)
MolProbity : 4.02b-467
buster-report : 1.1.7 (2018)
Percentile statistics : 20191225.v01 (using entries in the PDB archive December 25th 2019)
MapQ : 1.9.13
Ideal geometry (proteins) : Engh & Huber (2001)
Ideal geometry (DNA, RNA) : Parkinson et al. (1996)
Validation Pipeline (wwPDB-VP) : 2.36.2

1 Overall quality at a glance

The following experimental techniques were used to determine the structure:
ELECTRON MICROSCOPY

The reported resolution of this entry is 2.43 Å.

Percentile scores (ranging between 0-100) for global validation metrics of the entry are shown in the following graphic. The table shows the number of entries on which the scores are based.

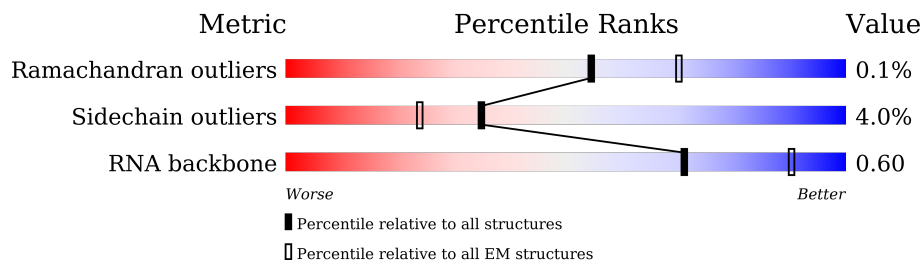

Metric	Whole archive (#Entries)	EM structures (#Entries)
Ramachandran outliers	154571	4023
Sidechain outliers	154315	3826
RNA backbone	4643	859

The table below summarises the geometric issues observed across the polymeric chains and their fit to the map. The red, orange, yellow and green segments of the bar indicate the fraction of residues that contain outliers for ≥ 3 , 2, 1 and 0 types of geometric quality criteria respectively. A grey segment represents the fraction of residues that are not modelled. The numeric value for each fraction is indicated below the corresponding segment, with a dot representing fractions $\leq 5\%$. The upper red bar (where present) indicates the fraction of residues that have poor fit to the EM map (all-atom inclusion $< 40\%$). The numeric value is given above the bar.

Mol	Chain	Length	Quality of chain
1	A	1542	
2	B	241	
3	C	233	
4	D	206	
5	E	167	
6	F	135	
7	G	179	
8	H	130	













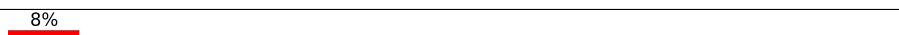
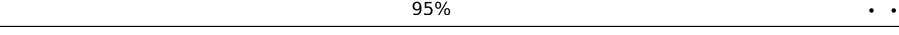
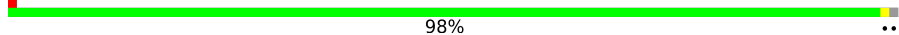

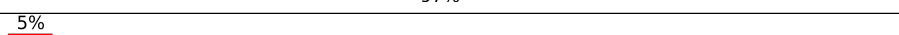
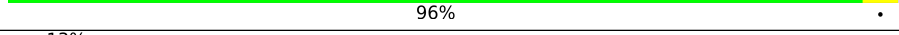
Continued on next page...

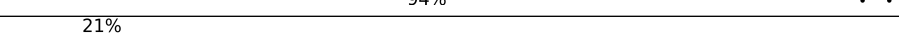
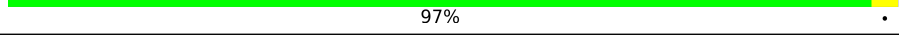
Continued from previous page...

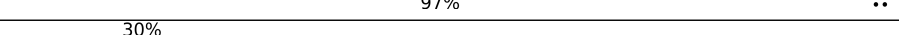
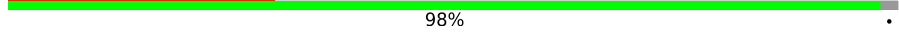
Mol	Chain	Length	Quality of chain
9	I	130	30% 95%
10	J	103	54% 93% 5%
11	K	129	16% 88% 9%
12	L	124	7% 95%
13	M	118	36% 93%
14	N	101	25% 99%
15	O	89	19% 96%
16	P	82	30% 98%
17	Q	84	25% 89% 5% 6%
18	R	75	24% 87% 12%
19	S	92	34% 89% 9%
20	T	87	31% 95%
21	U	71	54% 92% 7%
22	a	2904	6% 84% 11% 5%
23	b	120	5% 89% 10%
24	c	273	• 97%
25	d	209	5% 97%
26	e	201	14% 99%
27	f	179	38% 92% 7%
28	g	177	46% 94% 5%
29	h	149	11% 28% 72%
30	i	142	5% 96%
31	j	123	5% 97%
32	k	144	6% 97%
33	l	136	• 98%

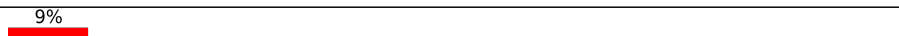
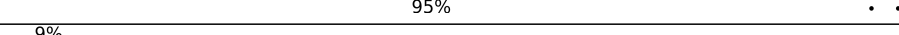
Continued on next page...

Continued from previous page...

Mol	Chain	Length	Quality of chain
34	m	127	 91% 7%
35	n	117	 13% 97%
36	o	115	 8% 95%
37	p	118	 98%
38	q	103	 10% 97%
39	r	110	 5% 96%
40	s	100	 13% 91% 7%
41	t	104	 20% 94%
42	u	94	 21% 97%
43	v	85	 91% 8%
44	w	78	 6% 97%
45	x	63	 30% 98%
46	y	59	 7% 95%
47	z	57	 9% 95%
48	0	55	 9% 91% 7%
49	1	46	 96%
50	2	65	 95%
51	3	38	 5% 95% 5%
52	4	70	 71% 81% 14%
53	5	76	 41% 68% 29%
54	6	77	 34% 71% 27%
55	7	10	 100%

2 Entry composition [i](#)

There are 60 unique types of molecules in this entry. The entry contains 142991 atoms, of which 481 are hydrogens and 0 are deuteriums.

In the tables below, the AltConf column contains the number of residues with at least one atom in alternate conformation and the Trace column contains the number of residues modelled with at most 2 atoms.

- Molecule 1 is a RNA chain called 16S ribosomal RNA.

Mol	Chain	Residues	Atoms					AltConf	Trace
			Total	C	N	O	P		
1	A	1519	32612	14552	5986	10555	1519	0	0

- Molecule 2 is a protein called 30S ribosomal protein S2.

Mol	Chain	Residues	Atoms					AltConf	Trace
			Total	C	N	O	S		
2	B	224	1753	1109	315	321	8	0	0

- Molecule 3 is a protein called 30S ribosomal protein S3.

Mol	Chain	Residues	Atoms					AltConf	Trace
			Total	C	N	O	S		
3	C	206	1624	1028	305	288	3	0	0

- Molecule 4 is a protein called 30S ribosomal protein S4.

Mol	Chain	Residues	Atoms					AltConf	Trace
			Total	C	N	O	S		
4	D	205	1643	1026	315	298	4	0	0

- Molecule 5 is a protein called 30S ribosomal protein S5.

Mol	Chain	Residues	Atoms					AltConf	Trace
			Total	C	N	O	S		
5	E	156	1152	717	217	212	6	0	0

- Molecule 6 is a protein called 30S ribosomal protein S6, fully modified isoform.

Mol	Chain	Residues	Atoms					AltConf	Trace
			Total	C	N	O	S		
6	F	103	839	530	151	151	7	0	0

- Molecule 7 is a protein called 30S ribosomal protein S7.

Mol	Chain	Residues	Atoms					AltConf	Trace
			Total	C	N	O	S		
7	G	153	1203	750	231	218	4	0	0

- Molecule 8 is a protein called 30S ribosomal protein S8.

Mol	Chain	Residues	Atoms					AltConf	Trace
			Total	C	N	O	S		
8	H	129	979	616	173	184	6	0	0

- Molecule 9 is a protein called 30S ribosomal protein S9.

Mol	Chain	Residues	Atoms					AltConf	Trace
			Total	C	N	O	S		
9	I	127	1022	634	206	179	3	0	0

- Molecule 10 is a protein called 30S ribosomal protein S10.

Mol	Chain	Residues	Atoms					AltConf	Trace
			Total	C	N	O	S		
10	J	98	786	493	150	142	1	0	0

- Molecule 11 is a protein called 30S ribosomal protein S11.

Mol	Chain	Residues	Atoms					AltConf	Trace
			Total	C	N	O	S		
11	K	117	877	540	173	161	3	0	0

There is a discrepancy between the modelled and reference sequences:

Chain	Residue	Modelled	Actual	Comment	Reference
K	119	IAS	ASN	modified residue	UNP P0A7R9

- Molecule 12 is a protein called 30S ribosomal protein S12.

Mol	Chain	Residues	Atoms					AltConf	Trace
			Total	C	N	O	S		
12	L	123	957	591	196	165	5	0	0

- Molecule 13 is a protein called 30S ribosomal protein S13.

Mol	Chain	Residues	Atoms					AltConf	Trace
			Total	C	N	O	S		
13	M	115	891	552	179	157	3	0	0

- Molecule 14 is a protein called 30S ribosomal protein S14.

Mol	Chain	Residues	Atoms					AltConf	Trace
			Total	C	N	O	S		
14	N	100	805	499	164	139	3	0	0

- Molecule 15 is a protein called 30S ribosomal protein S15.

Mol	Chain	Residues	Atoms					AltConf	Trace
			Total	C	N	O	S		
15	O	88	714	439	144	130	1	0	0

- Molecule 16 is a protein called 30S ribosomal protein S16.

Mol	Chain	Residues	Atoms					AltConf	Trace
			Total	C	N	O	S		
16	P	81	643	403	127	112	1	0	0

- Molecule 17 is a protein called 30S ribosomal protein S17.

Mol	Chain	Residues	Atoms					AltConf	Trace
			Total	C	N	O	S		
17	Q	79	641	406	120	112	3	0	0

- Molecule 18 is a protein called 30S ribosomal protein S18.

Mol	Chain	Residues	Atoms					AltConf	Trace
			Total	C	N	O	S		
18	R	66	544	345	102	96	1	0	0

- Molecule 19 is a protein called 30S ribosomal protein S19.

Mol	Chain	Residues	Atoms					AltConf	Trace
			Total	C	N	O	S		
19	S	84	668	427	127	112	2	0	0

- Molecule 20 is a protein called 30S ribosomal protein S20.

Mol	Chain	Residues	Atoms					AltConf	Trace
20	T	86	Total	C	N	O	S	0	0
			670	414	138	115	3		

- Molecule 21 is a protein called 30S ribosomal protein S21.

Mol	Chain	Residues	Atoms					AltConf	Trace
21	U	70	Total	C	N	O	S	0	0
			589	366	125	97	1		

- Molecule 22 is a RNA chain called 23S ribosomal RNA.

Mol	Chain	Residues	Atoms					AltConf	Trace
22	a	2753	Total	C	N	O	P	0	0
			59130	26384	10897	19096	2753		

- Molecule 23 is a RNA chain called 5S ribosomal RNA.

Mol	Chain	Residues	Atoms					AltConf	Trace
23	b	119	Total	C	N	O	P	0	0
			2549	1135	466	829	119		

- Molecule 24 is a protein called 50S ribosomal protein L2.

Mol	Chain	Residues	Atoms					AltConf	Trace
24	c	271	Total	C	N	O	S	0	0
			2082	1288	423	364	7		

- Molecule 25 is a protein called 50S ribosomal protein L3.

Mol	Chain	Residues	Atoms					AltConf	Trace
25	d	209	Total	C	N	O	S	0	0
			1566	980	288	294	4		

- Molecule 26 is a protein called 50S ribosomal protein L4.

Mol	Chain	Residues	Atoms					AltConf	Trace
26	e	201	Total	C	N	O	S	0	0
			1552	974	283	290	5		

- Molecule 27 is a protein called 50S ribosomal protein L5.

Mol	Chain	Residues	Atoms					AltConf	Trace
			Total	C	N	O	S		
27	f	177	1410	899	249	256	6	0	0

- Molecule 28 is a protein called 50S ribosomal protein L6.

Mol	Chain	Residues	Atoms					AltConf	Trace
			Total	C	N	O	S		
28	g	176	1323	832	243	246	2	0	0

- Molecule 29 is a protein called 50S ribosomal protein L9.

Mol	Chain	Residues	Atoms					AltConf	Trace
			Total	C	N	O	S		
29	h	41	303	194	54	54	1	0	0

- Molecule 30 is a protein called 50S ribosomal protein L13.

Mol	Chain	Residues	Atoms					AltConf	Trace
			Total	C	N	O	S		
30	i	142	1129	714	212	199	4	0	0

- Molecule 31 is a protein called 50S ribosomal protein L14.

Mol	Chain	Residues	Atoms					AltConf	Trace
			Total	C	N	O	S		
31	j	123	946	593	181	166	6	0	0

- Molecule 32 is a protein called 50S ribosomal protein L15.

Mol	Chain	Residues	Atoms					AltConf	Trace
			Total	C	N	O	S		
32	k	144	1053	654	207	190	2	0	0

- Molecule 33 is a protein called 50S ribosomal protein L16.

Mol	Chain	Residues	Atoms					AltConf	Trace
			Total	C	N	O	S		
33	l	136	1075	686	205	177	7	0	0

There is a discrepancy between the modelled and reference sequences:

Chain	Residue	Modelled	Actual	Comment	Reference
l	82	MS6	MET	modified residue	UNP P0ADY7

- Molecule 34 is a protein called 50S ribosomal protein L17.

Mol	Chain	Residues	Atoms					AltConf	Trace
			Total	C	N	O	S		
34	m	118	945	585	194	161	5	0	0

- Molecule 35 is a protein called 50S ribosomal protein L18.

Mol	Chain	Residues	Atoms				AltConf	Trace
			Total	C	N	O		
35	n	116	892	552	178	162	0	0

- Molecule 36 is a protein called 50S ribosomal protein L19.

Mol	Chain	Residues	Atoms					AltConf	Trace
			Total	C	N	O	S		
36	o	114	917	574	179	163	1	0	0

- Molecule 37 is a protein called 50S ribosomal protein L20.

Mol	Chain	Residues	Atoms				AltConf	Trace
			Total	C	N	O		
37	p	117	947	604	192	151	0	0

- Molecule 38 is a protein called 50S ribosomal protein L21.

Mol	Chain	Residues	Atoms					AltConf	Trace
			Total	C	N	O	S		
38	q	103	816	516	153	145	2	0	0

- Molecule 39 is a protein called 50S ribosomal protein L22.

Mol	Chain	Residues	Atoms					AltConf	Trace
			Total	C	N	O	S		
39	r	110	857	532	166	156	3	0	0

- Molecule 40 is a protein called 50S ribosomal protein L23.

Mol	Chain	Residues	Atoms					AltConf	Trace
			Total	C	N	O	S		
40	s	93	738	466	139	131	2	0	0

- Molecule 41 is a protein called 50S ribosomal protein L24.

Mol	Chain	Residues	Atoms					AltConf	Trace
			Total	C	N	O	S		
41	t	102	779	492	146	141		0	0

- Molecule 42 is a protein called 50S ribosomal protein L25.

Mol	Chain	Residues	Atoms					AltConf	Trace
			Total	C	N	O	S		
42	u	94	753	479	137	134	3	0	0

- Molecule 43 is a protein called 50S ribosomal protein L27.

Mol	Chain	Residues	Atoms					AltConf	Trace
			Total	C	N	O	S		
43	v	78	586	362	116	107	1	0	0

- Molecule 44 is a protein called 50S ribosomal protein L28.

Mol	Chain	Residues	Atoms					AltConf	Trace
			Total	C	N	O	S		
44	w	77	625	388	129	106	2	0	0

- Molecule 45 is a protein called 50S ribosomal protein L29.

Mol	Chain	Residues	Atoms					AltConf	Trace
			Total	C	N	O	S		
45	x	62	501	308	98	94	1	0	0

- Molecule 46 is a protein called 50S ribosomal protein L30.

Mol	Chain	Residues	Atoms					AltConf	Trace
			Total	C	N	O	S		
46	y	58	449	281	87	79	2	0	0

- Molecule 47 is a protein called 50S ribosomal protein L32.

Mol	Chain	Residues	Atoms					AltConf	Trace
47	z	56	Total	C	N	O	S	0	0
			444	269	94	80	1		

- Molecule 48 is a protein called 50S ribosomal protein L33.

Mol	Chain	Residues	Atoms				AltConf	Trace
48	0	51	Total	C	N	O	0	0
			417	269	76	72		

- Molecule 49 is a protein called 50S ribosomal protein L34.

Mol	Chain	Residues	Atoms					AltConf	Trace
49	1	46	Total	C	N	O	S	0	0
			377	228	90	57	2		

- Molecule 50 is a protein called 50S ribosomal protein L35.

Mol	Chain	Residues	Atoms					AltConf	Trace
50	2	64	Total	C	N	O	S	0	0
			504	323	105	74	2		

- Molecule 51 is a protein called 50S ribosomal protein L36.

Mol	Chain	Residues	Atoms					AltConf	Trace
51	3	38	Total	C	N	O	S	0	0
			302	185	65	48	4		

- Molecule 52 is a protein called 50S ribosomal protein L31.

Mol	Chain	Residues	Atoms					AltConf	Trace
52	4	60	Total	C	N	O	S	0	0
			480	299	90	85	6		

- Molecule 53 is a RNA chain called A-site tRNA-Phe.

Mol	Chain	Residues	Atoms						AltConf	Trace
53	5	76	Total	C	N	O	P	S	0	0
			1632	731	290	533	76	2		

- Molecule 54 is a RNA chain called P-site tRNA-fMet.

Mol	Chain	Residues	Atoms					AltConf	Trace	
			Total	C	N	O	P			S
54	6	77	1645	734	297	536	77	1	0	0

- Molecule 55 is a RNA chain called mRNA.

Mol	Chain	Residues	Atoms					AltConf	Trace
			Total	C	N	O	P		
55	7	10	209	95	37	68	9	0	0

- Molecule 56 is MAGNESIUM ION (three-letter code: MG) (formula: Mg).

Mol	Chain	Residues	Atoms		AltConf
56	A	135	Total	Mg	0
			135	135	
56	C	3	Total	Mg	0
			3	3	
56	G	1	Total	Mg	0
			1	1	
56	M	4	Total	Mg	0
			4	4	
56	a	241	Total	Mg	0
			241	241	
56	b	8	Total	Mg	0
			8	8	
56	c	2	Total	Mg	0
			2	2	
56	d	5	Total	Mg	0
			5	5	
56	z	4	Total	Mg	0
			4	4	
56	4	1	Total	Mg	0
			1	1	
56	6	1	Total	Mg	0
			1	1	
56	7	1	Total	Mg	0
			1	1	

- Molecule 57 is SPERMIDINE (three-letter code: SPD) (formula: C₇H₁₉N₃).

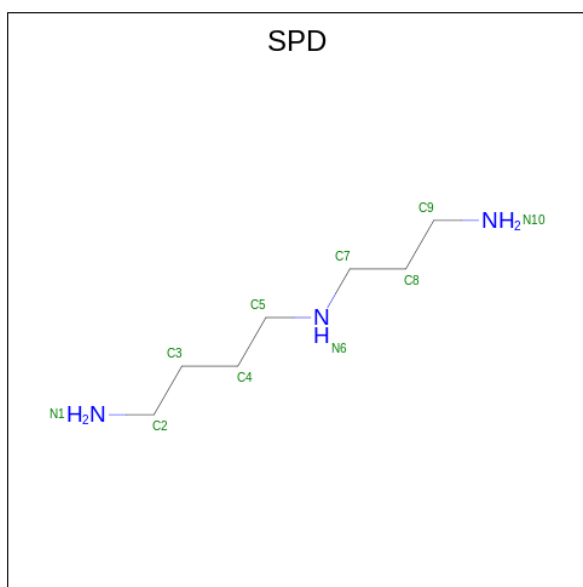

Mol	Chain	Residues	Atoms			AltConf
			Total	C	N	
57	A	1	10	7	3	0
57	A	1	10	7	3	0
57	a	1	10	7	3	0
57	a	1	10	7	3	0
57	a	1	10	7	3	0
57	a	1	10	7	3	0
57	a	1	10	7	3	0
57	a	1	10	7	3	0
57	a	1	10	7	3	0
57	a	1	10	7	3	0
57	a	1	10	7	3	0
57	a	1	10	7	3	0
57	a	1	10	7	3	0
57	a	1	10	7	3	0

- Molecule 58 is Dibekacin (three-letter code: 84D) (formula: C₁₈H₃₇N₅O₈) (labeled as "Ligand of Interest" by depositor).

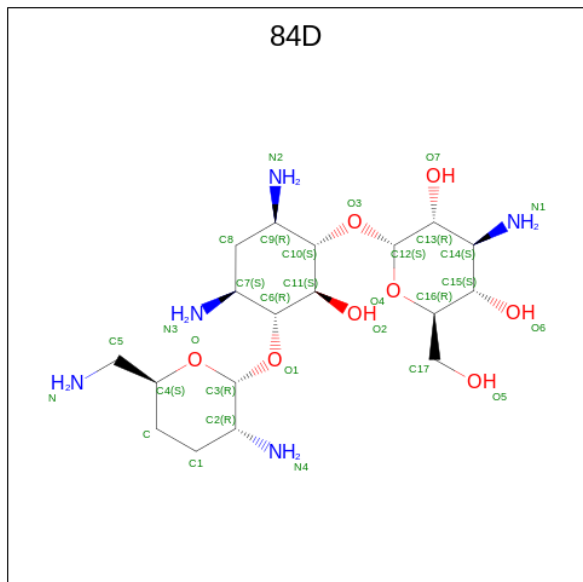

Mol	Chain	Residues	Atoms				AltConf	
			Total	C	H	N		O
58	A	1	Total	C	H	N	O	0
			68	18	37	5	8	
58	A	1	Total	C	H	N	O	0
			68	18	37	5	8	
58	A	1	Total	C	H	N	O	0
			68	18	37	5	8	
58	A	1	Total	C	H	N	O	0
			68	18	37	5	8	
58	A	1	Total	C	H	N	O	0
			68	18	37	5	8	
58	a	1	Total	C	H	N	O	0
			68	18	37	5	8	
58	a	1	Total	C	H	N	O	0
			68	18	37	5	8	
58	a	1	Total	C	H	N	O	0
			68	18	37	5	8	
58	a	1	Total	C	H	N	O	0
			68	18	37	5	8	
58	a	1	Total	C	H	N	O	0
			68	18	37	5	8	
58	a	1	Total	C	H	N	O	0
			68	18	37	5	8	

Continued on next page...

Continued from previous page...

Mol	Chain	Residues	Atoms					AltConf
			Total	C	H	N	O	
58	a	1	68	18	37	5	8	0

- Molecule 59 is SPERMINE (three-letter code: SPM) (formula: $C_{10}H_{26}N_4$).

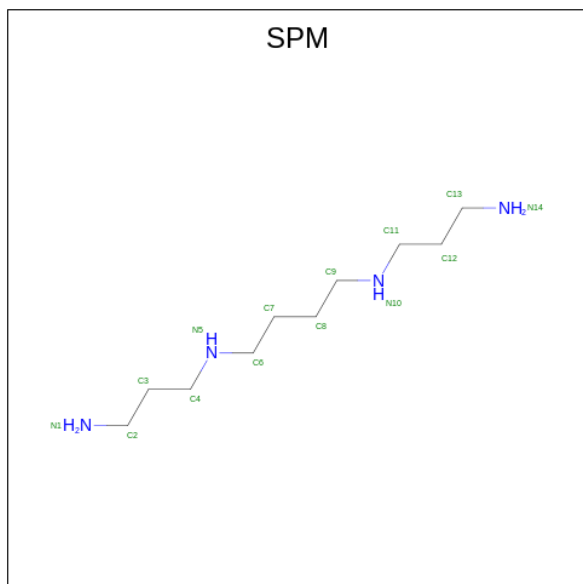

Mol	Chain	Residues	Atoms			AltConf
			Total	C	N	
59	a	1	14	10	4	0

- Molecule 60 is ZINC ION (three-letter code: ZN) (formula: Zn).

Mol	Chain	Residues	Atoms		AltConf
			Total	Zn	
60	3	1	1	1	0
60	4	1	1	1	0

3 Residue-property plots

These plots are drawn for all protein, RNA, DNA and oligosaccharide chains in the entry. The first graphic for a chain summarises the proportions of the various outlier classes displayed in the second graphic. The second graphic shows the sequence view annotated by issues in geometry and atom inclusion in map density. Residues are color-coded according to the number of geometric quality criteria for which they contain at least one outlier: green = 0, yellow = 1, orange = 2 and red = 3 or more. A red diamond above a residue indicates a poor fit to the EM map for this residue (all-atom inclusion < 40%). Stretches of 2 or more consecutive residues without any outlier are shown as a green connector. Residues present in the sample, but not in the model, are shown in grey.

- Molecule 1: 16S ribosomal RNA

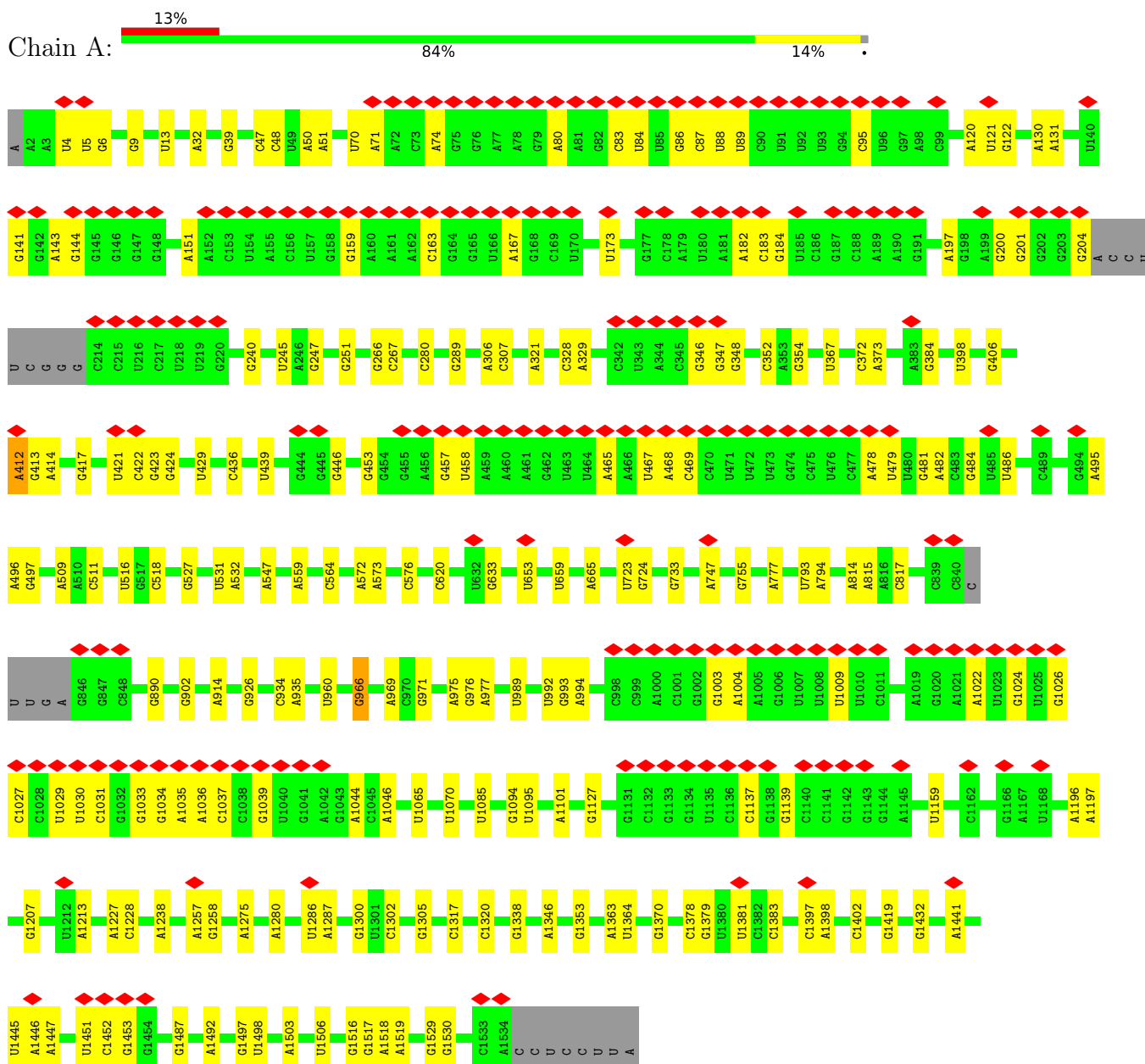

- Molecule 2: 30S ribosomal protein S2

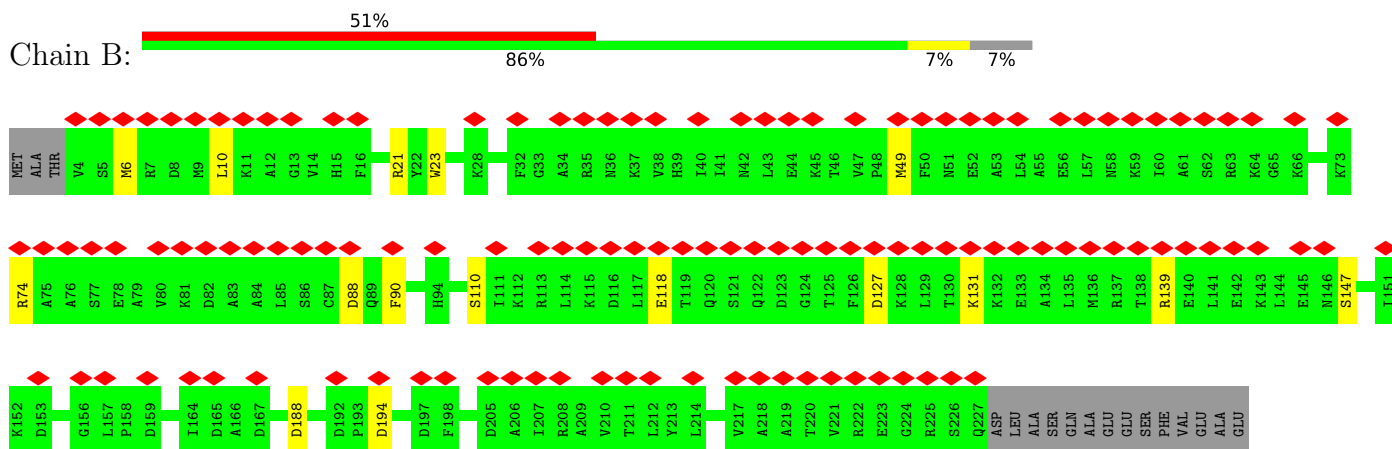

- Molecule 3: 30S ribosomal protein S3

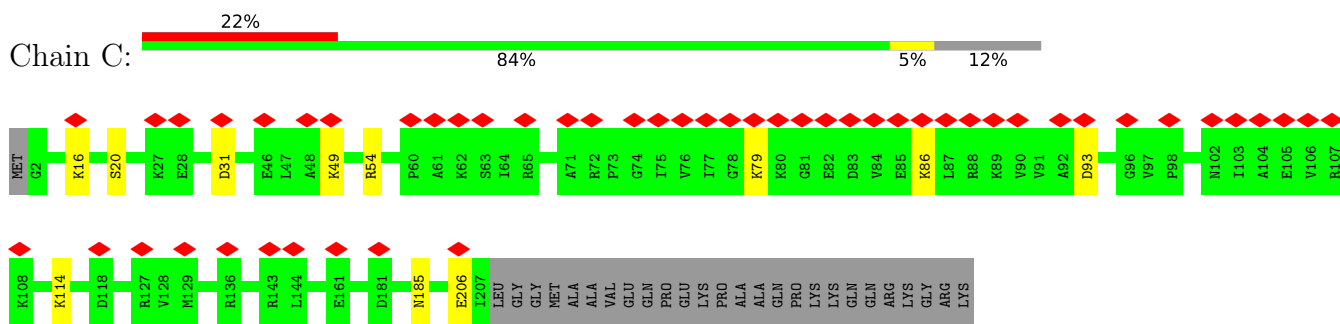

- Molecule 4: 30S ribosomal protein S4

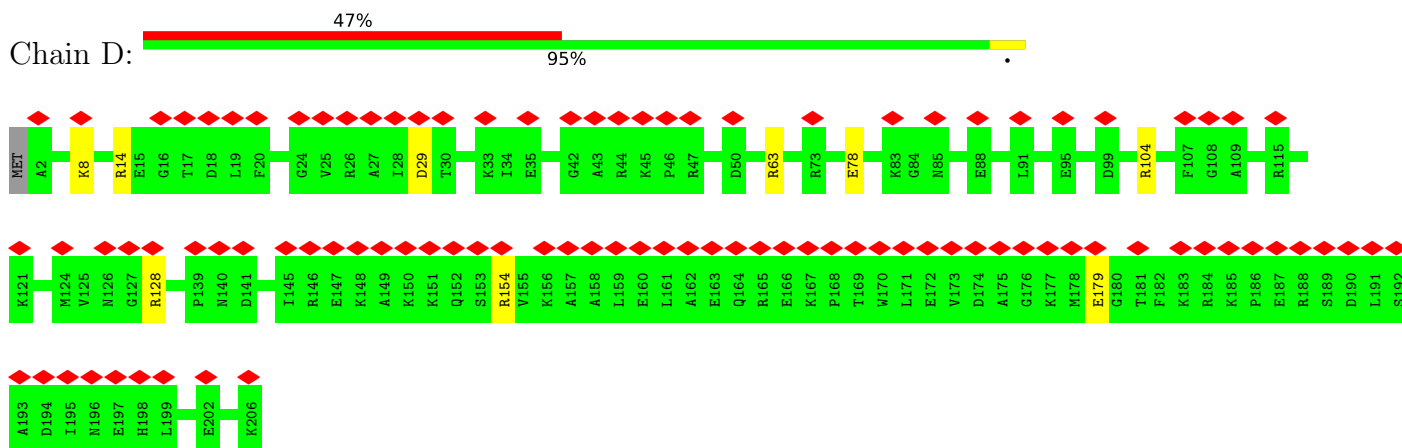

- Molecule 5: 30S ribosomal protein S5

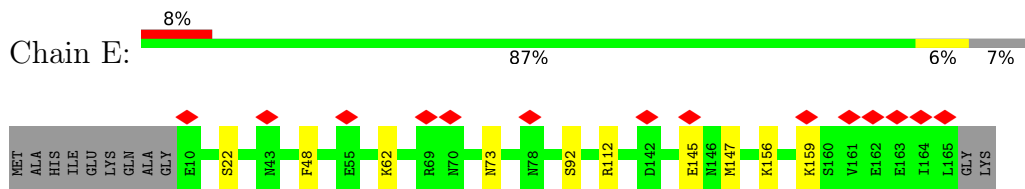

- Molecule 6: 30S ribosomal protein S6, fully modified isoform

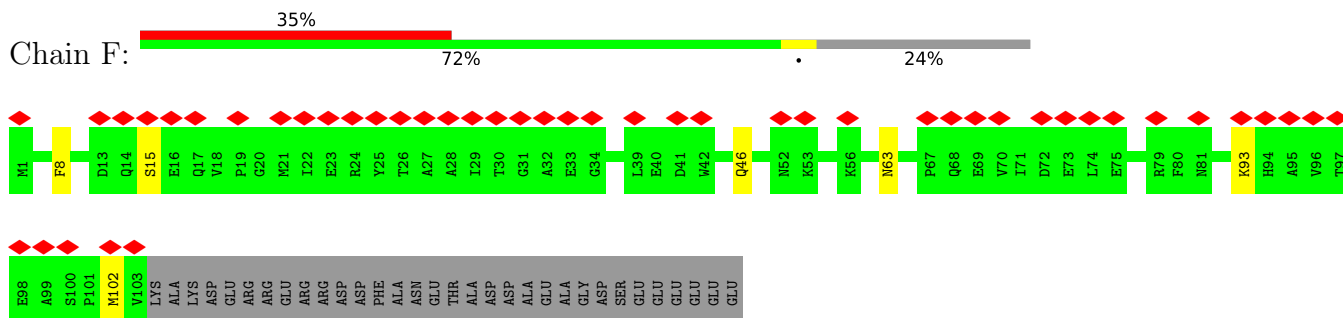

- Molecule 7: 30S ribosomal protein S7

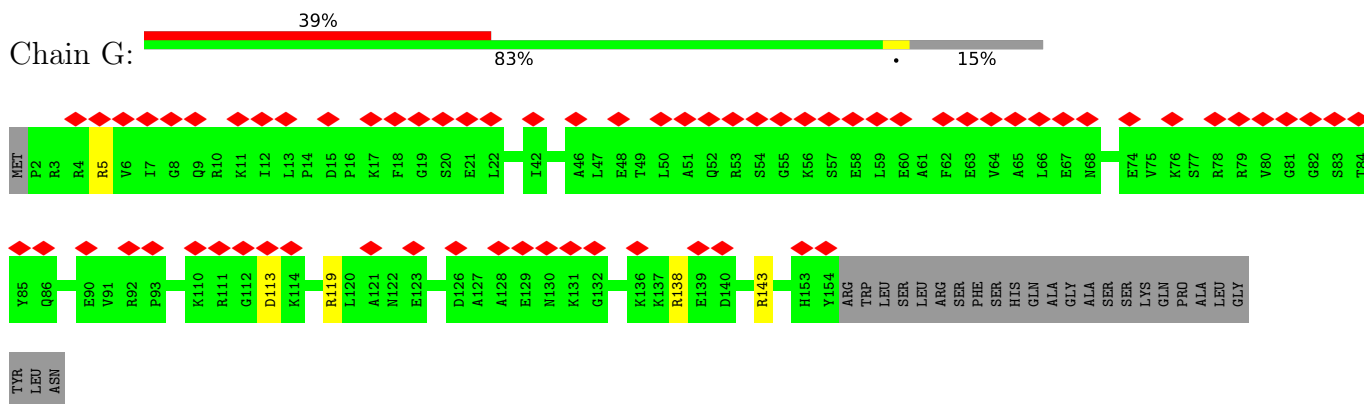

- Molecule 8: 30S ribosomal protein S8

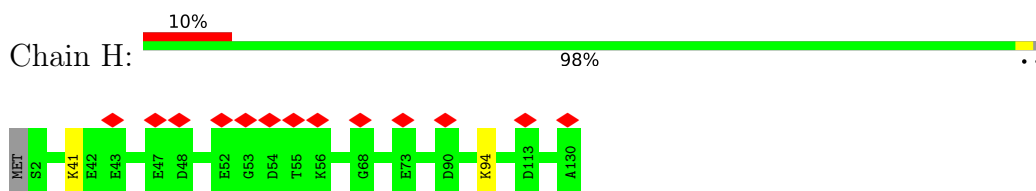

- Molecule 9: 30S ribosomal protein S9

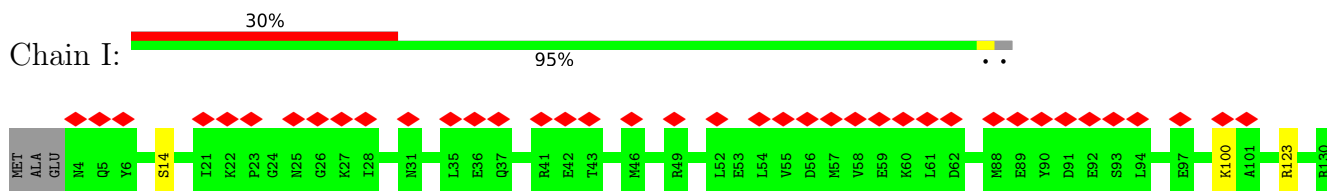

- Molecule 10: 30S ribosomal protein S10

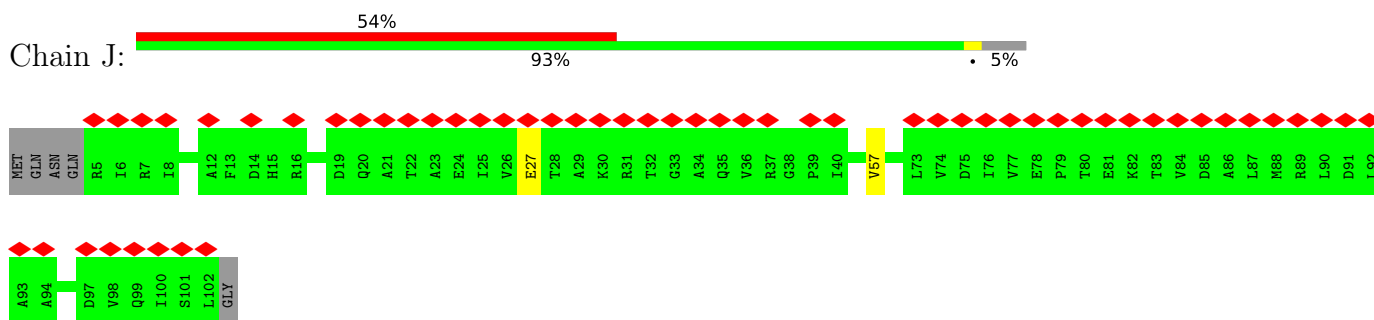

- Molecule 11: 30S ribosomal protein S11

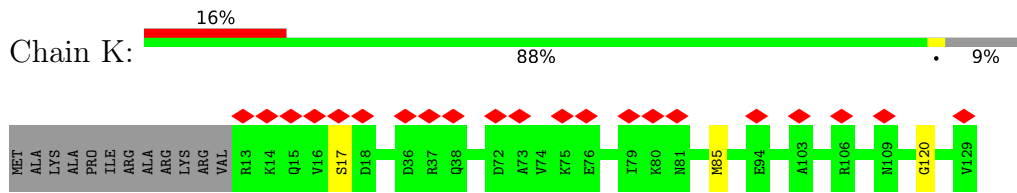

- Molecule 12: 30S ribosomal protein S12

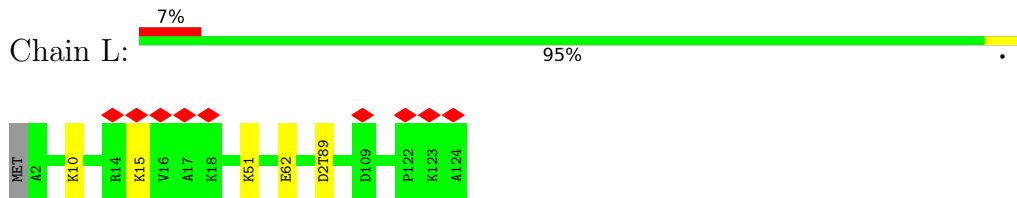

- Molecule 13: 30S ribosomal protein S13

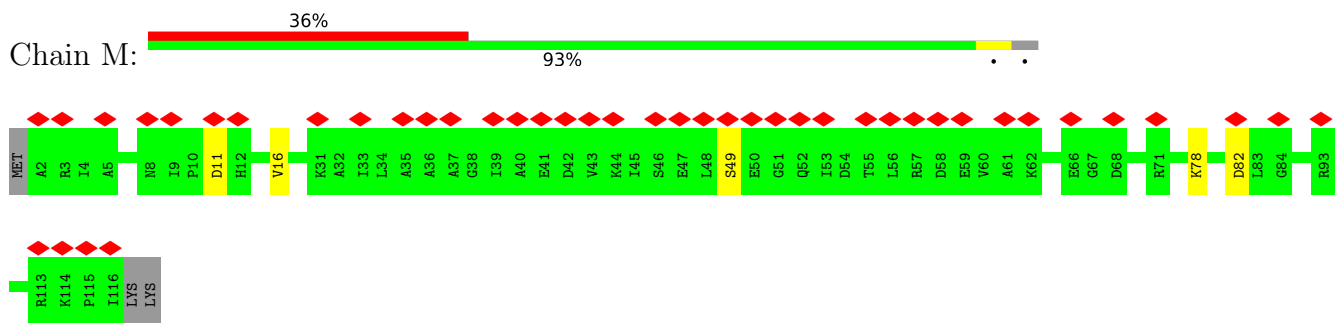

- Molecule 14: 30S ribosomal protein S14

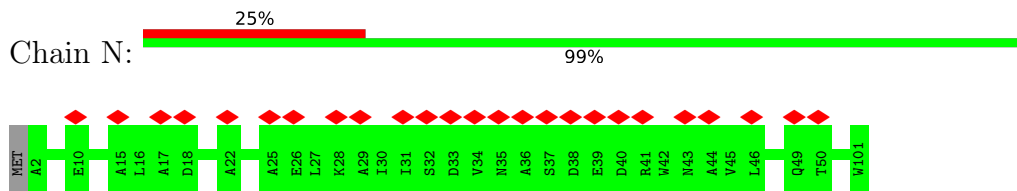

- Molecule 15: 30S ribosomal protein S15

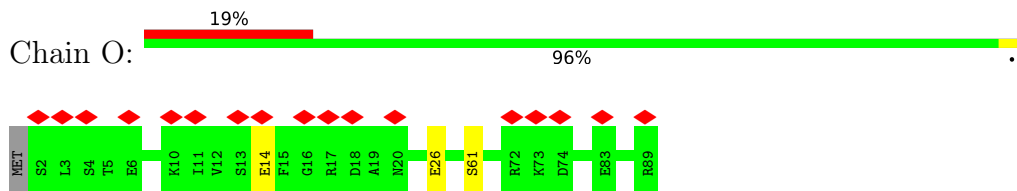

- Molecule 16: 30S ribosomal protein S16

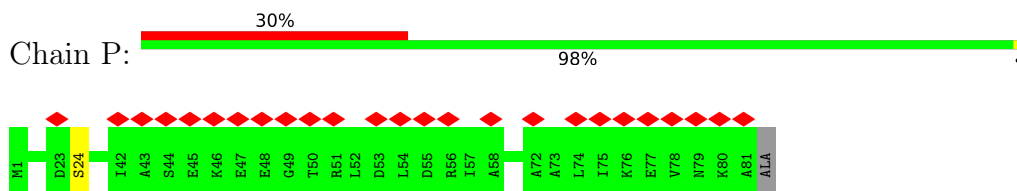

- Molecule 17: 30S ribosomal protein S17

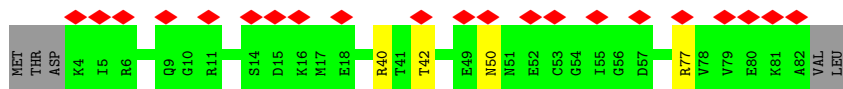
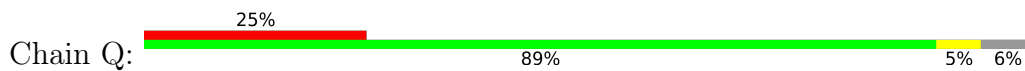

• Molecule 18: 30S ribosomal protein S18

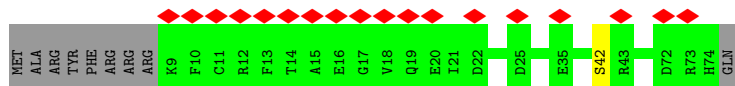
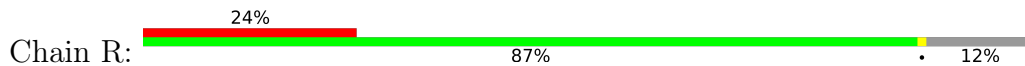

• Molecule 19: 30S ribosomal protein S19

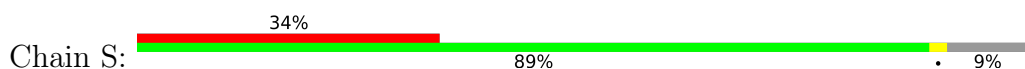

• Molecule 20: 30S ribosomal protein S20

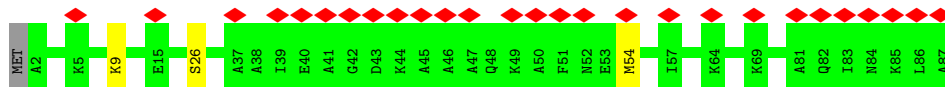
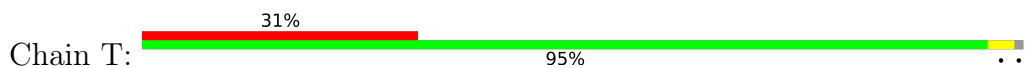

• Molecule 21: 30S ribosomal protein S21

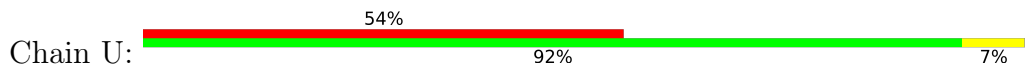

• Molecule 22: 23S ribosomal RNA

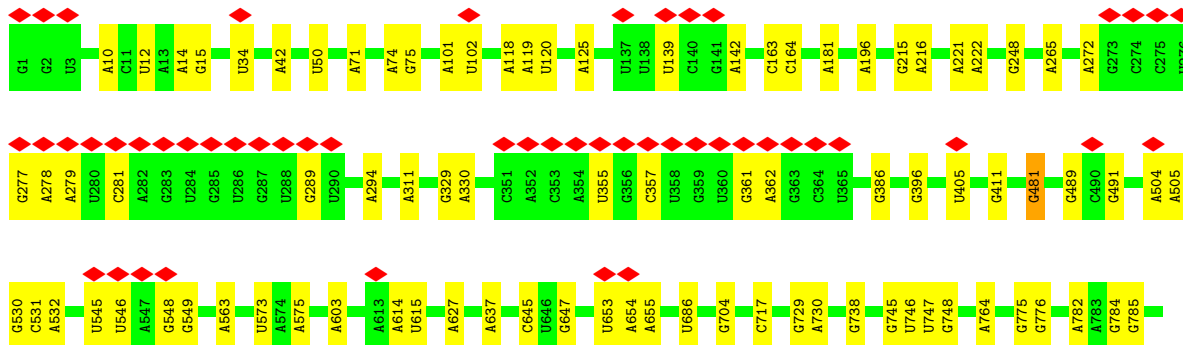
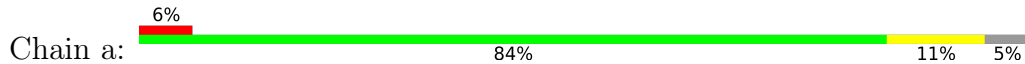

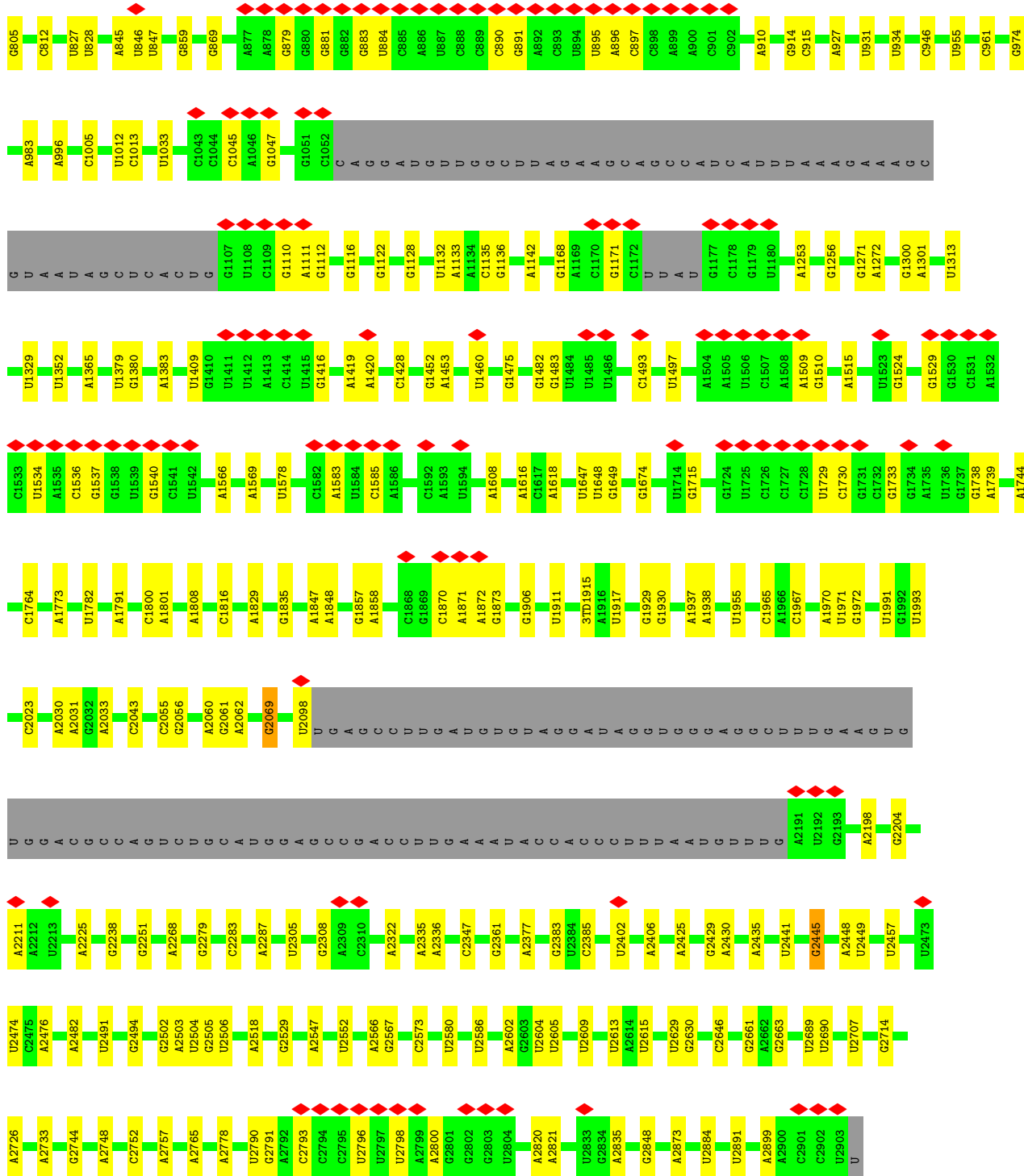

• Molecule 23: 5S ribosomal RNA

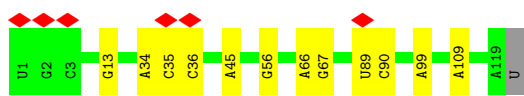
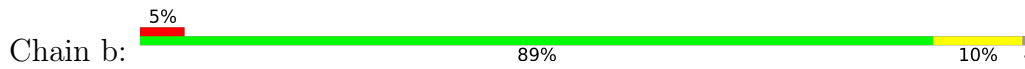

- Molecule 24: 50S ribosomal protein L2

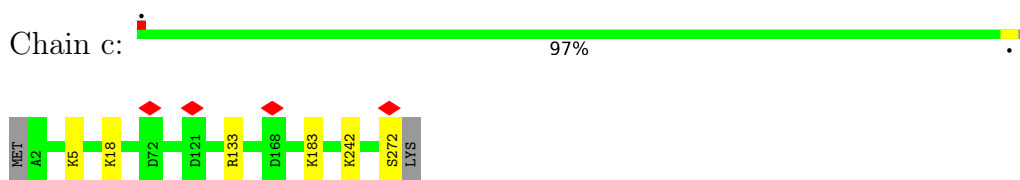

- Molecule 25: 50S ribosomal protein L3

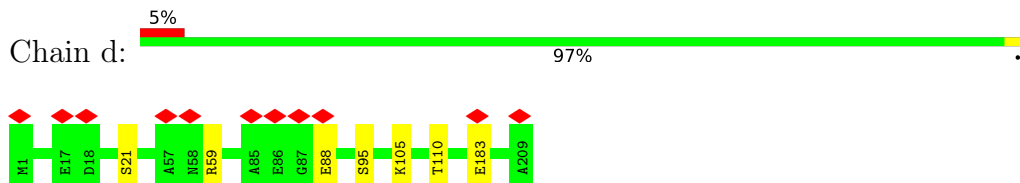

- Molecule 26: 50S ribosomal protein L4

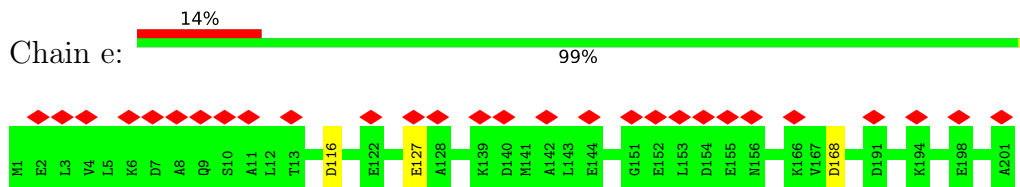

- Molecule 27: 50S ribosomal protein L5

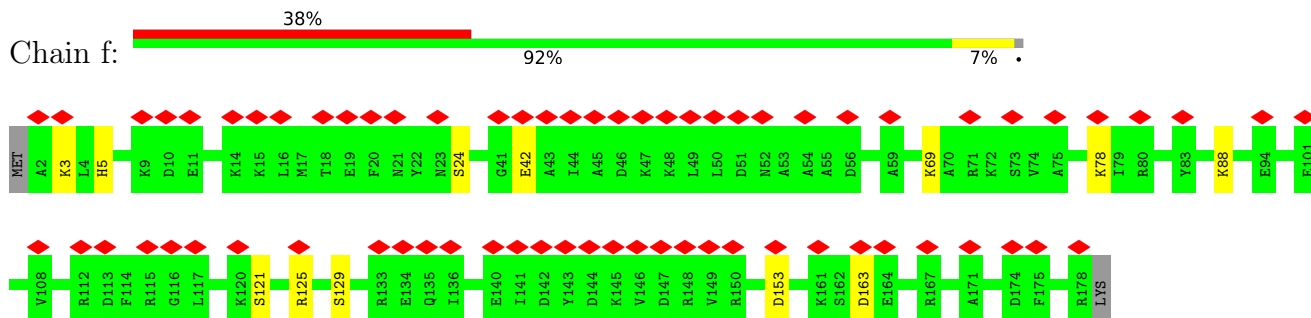

- Molecule 28: 50S ribosomal protein L6

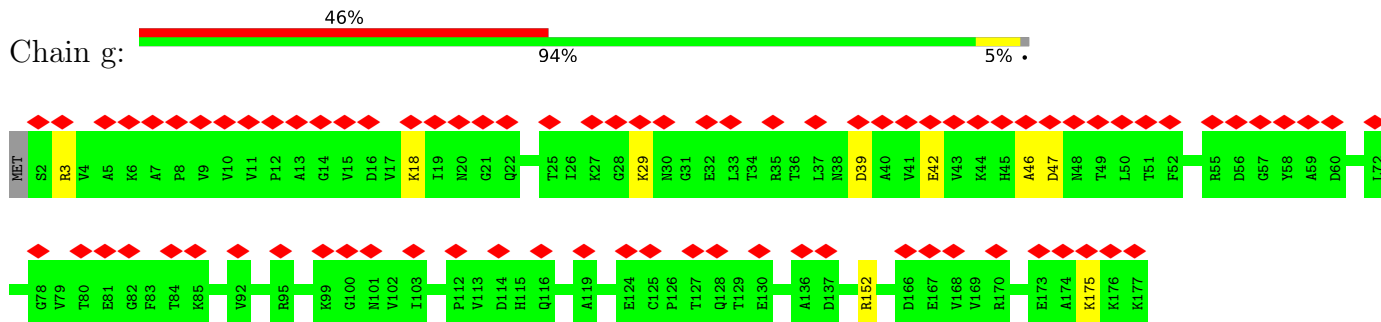

- Molecule 29: 50S ribosomal protein L9



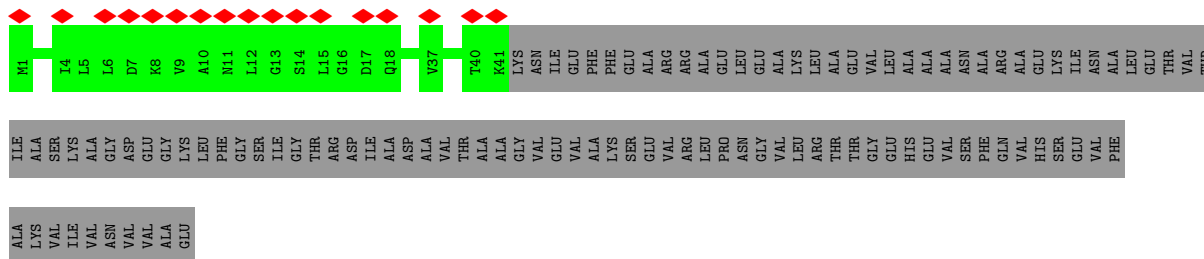

• Molecule 30: 50S ribosomal protein L13

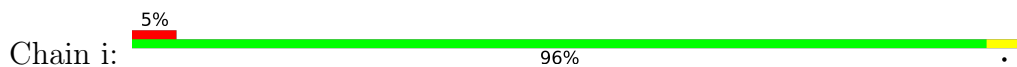

• Molecule 31: 50S ribosomal protein L14



• Molecule 32: 50S ribosomal protein L15

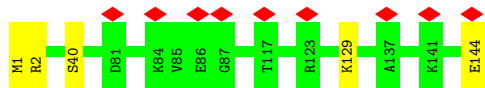

• Molecule 33: 50S ribosomal protein L16

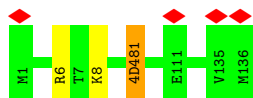

• Molecule 34: 50S ribosomal protein L17

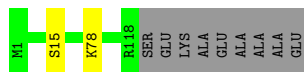

• Molecule 35: 50S ribosomal protein L18



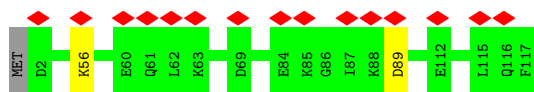

- Molecule 36: 50S ribosomal protein L19

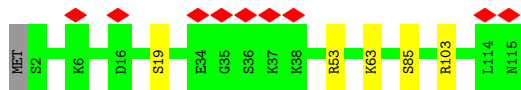
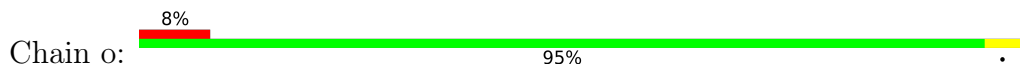

- Molecule 37: 50S ribosomal protein L20

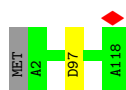

- Molecule 38: 50S ribosomal protein L21

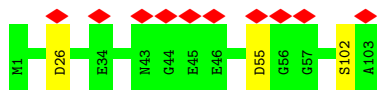

- Molecule 39: 50S ribosomal protein L22

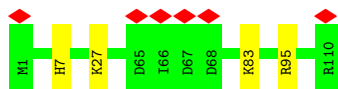

- Molecule 40: 50S ribosomal protein L23

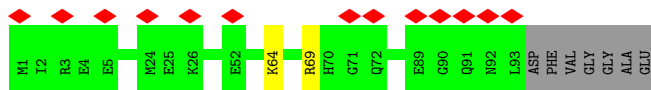
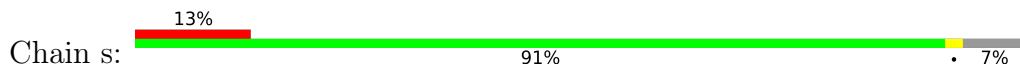

- Molecule 41: 50S ribosomal protein L24

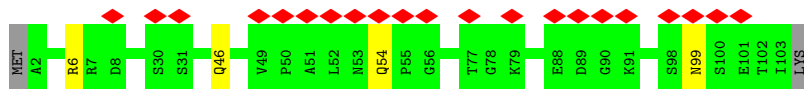

- Molecule 42: 50S ribosomal protein L25

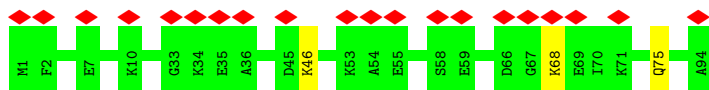

• Molecule 43: 50S ribosomal protein L27

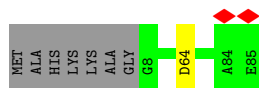
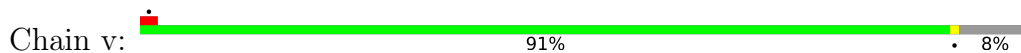

• Molecule 44: 50S ribosomal protein L28

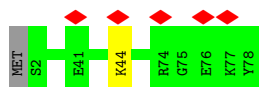

• Molecule 45: 50S ribosomal protein L29

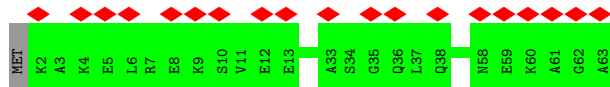

• Molecule 46: 50S ribosomal protein L30

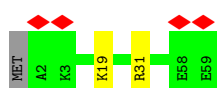

• Molecule 47: 50S ribosomal protein L32

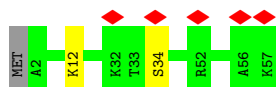

• Molecule 48: 50S ribosomal protein L33

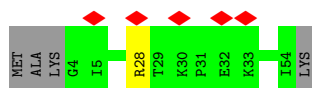

- Molecule 49: 50S ribosomal protein L34

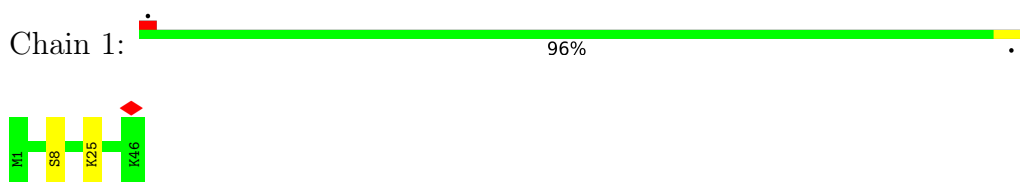

- Molecule 50: 50S ribosomal protein L35

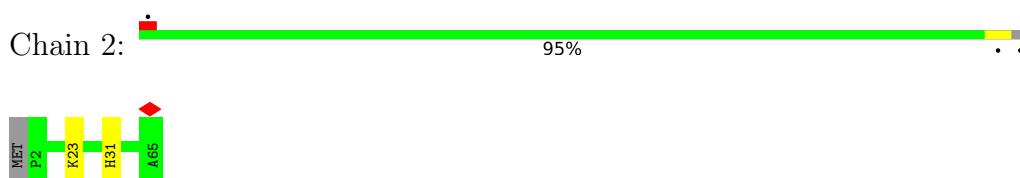

- Molecule 51: 50S ribosomal protein L36

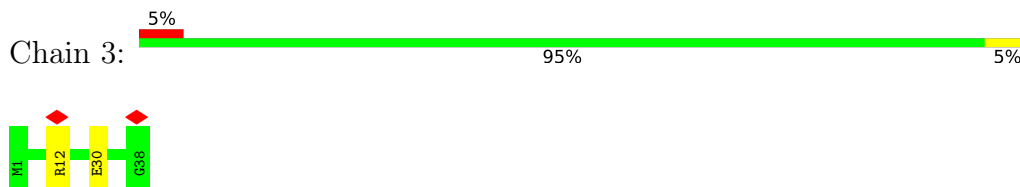

- Molecule 52: 50S ribosomal protein L31

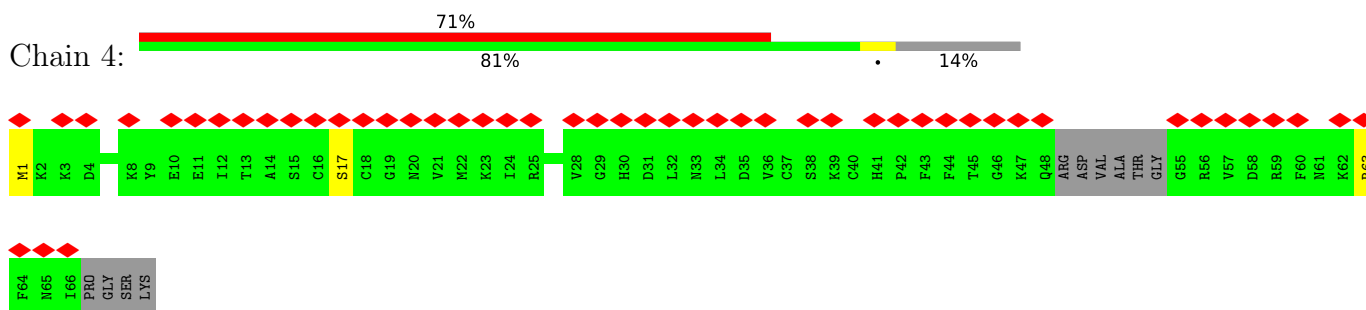

- Molecule 53: A-site tRNA-Phe

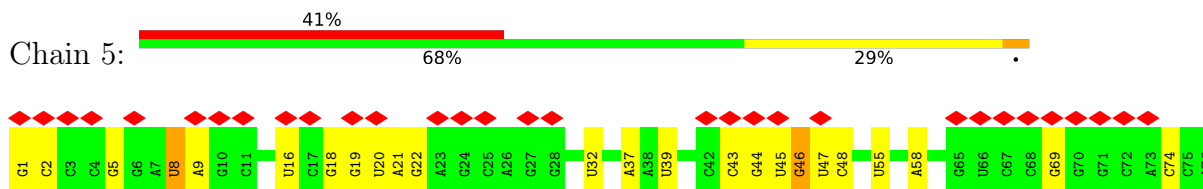

- Molecule 54: P-site tRNA-fMet

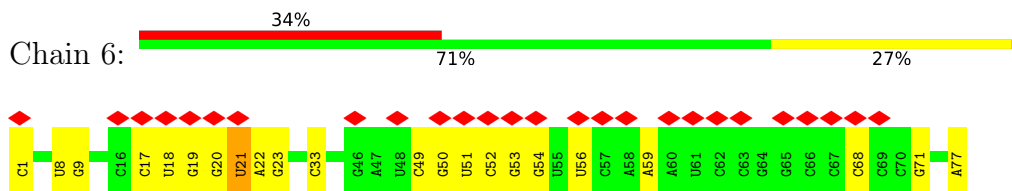

- Molecule 55: mRNA

Chain 7:  100%

There are no outlier residues recorded for this chain.

4 Experimental information

Property	Value	Source
EM reconstruction method	SINGLE PARTICLE	Depositor
Imposed symmetry	POINT, Not provided	
Number of particles used	180055	Depositor
Resolution determination method	FSC 0.143 CUT-OFF	Depositor
CTF correction method	PHASE FLIPPING AND AMPLITUDE CORRECTION	Depositor
Microscope	JEOL CRYO ARM 300	Depositor
Voltage (kV)	300	Depositor
Electron dose ($e^-/\text{\AA}^2$)	40	Depositor
Minimum defocus (nm)	1100	Depositor
Maximum defocus (nm)	2300	Depositor
Magnification	60000	Depositor
Image detector	GATAN K3 (6k x 4k)	Depositor
Maximum map value	0.254	Depositor
Minimum map value	-0.109	Depositor
Average map value	0.000	Depositor
Map value standard deviation	0.007	Depositor
Recommended contour level	0.027	Depositor
Map size (Å)	403.456, 403.456, 403.456	wwPDB
Map dimensions	512, 512, 512	wwPDB
Map angles (°)	90.0, 90.0, 90.0	wwPDB
Pixel spacing (Å)	0.788, 0.788, 0.788	Depositor

5 Model quality i

5.1 Standard geometry i

Bond lengths and bond angles in the following residue types are not validated in this section: H2U, 5MU, IAS, 84D, MA6, 3TD, OMG, OMU, SPM, MIA, 1MG, D2T, 2MG, PSU, MEQ, UR3, OMC, 6MZ, SPD, G7M, 4SU, MG, MS6, ZN, 4D4, 5MC, 2MA, 4OC

The Z score for a bond length (or angle) is the number of standard deviations the observed value is removed from the expected value. A bond length (or angle) with $|Z| > 5$ is considered an outlier worth inspection. RMSZ is the root-mean-square of all Z scores of the bond lengths (or angles).

Mol	Chain	Bond lengths		Bond angles	
		RMSZ	# Z >5	RMSZ	# Z >5
1	A	0.53	0/36236	0.80	6/56520 (0.0%)
2	B	0.31	0/1784	0.56	1/2403 (0.0%)
3	C	0.30	0/1651	0.55	0/2225
4	D	0.28	0/1665	0.55	0/2227
5	E	0.31	0/1165	0.54	0/1568
6	F	0.30	0/858	0.55	0/1160
7	G	0.28	0/1219	0.57	0/1635
8	H	0.29	0/989	0.54	0/1326
9	I	0.29	0/1034	0.59	0/1375
10	J	0.30	0/796	0.62	0/1077
11	K	0.37	1/884 (0.1%)	0.58	0/1191
12	L	0.31	0/960	0.62	0/1286
13	M	0.27	0/900	0.57	0/1204
14	N	0.28	0/817	0.57	0/1088
15	O	0.28	0/722	0.56	0/964
16	P	0.28	0/653	0.58	0/877
17	Q	0.29	0/650	0.55	0/871
18	R	0.31	0/553	0.57	0/742
19	S	0.29	0/685	0.56	0/922
20	T	0.30	0/676	0.50	0/895
21	U	0.31	0/597	0.62	0/792
22	a	0.67	0/65651	0.82	8/102413 (0.0%)
23	b	0.53	0/2850	0.78	0/4444
24	c	0.32	0/2121	0.60	0/2852
25	d	0.32	0/1576	0.55	0/2119
26	e	0.30	0/1571	0.55	0/2113
27	f	0.30	0/1434	0.55	0/1926
28	g	0.30	0/1343	0.59	0/1816
29	h	0.29	0/306	0.62	0/413
30	i	0.33	0/1152	0.53	0/1551
31	j	0.32	0/955	0.60	0/1279

Mol	Chain	Bond lengths		Bond angles	
		RMSZ	# Z >5	RMSZ	# Z >5
32	k	0.31	0/1062	0.61	0/1413
33	l	0.33	0/1073	0.58	0/1433
34	m	0.32	0/958	0.60	0/1281
35	n	0.28	0/902	0.57	0/1209
36	o	0.31	0/929	0.58	0/1242
37	p	0.34	0/960	0.57	0/1278
38	q	0.32	0/829	0.59	0/1107
39	r	0.29	0/864	0.56	0/1156
40	s	0.29	0/744	0.54	0/994
41	t	0.30	0/787	0.57	0/1051
42	u	0.30	0/766	0.52	0/1025
43	v	0.32	0/593	0.56	0/785
44	w	0.32	0/635	0.61	0/848
45	x	0.26	0/502	0.53	0/667
46	y	0.27	0/453	0.58	0/605
47	z	0.31	0/450	0.60	0/599
48	0	0.33	0/424	0.58	0/565
49	1	0.29	0/380	0.66	0/498
50	2	0.32	0/513	0.58	0/676
51	3	0.34	0/303	0.61	0/397
52	4	0.30	0/488	0.53	0/649
53	5	0.47	1/1651 (0.1%)	0.87	2/2569 (0.1%)
54	6	0.49	1/1725 (0.1%)	0.92	4/2687 (0.1%)
55	7	0.44	0/233	0.81	0/361
All	All	0.54	3/152677 (0.0%)	0.76	21/228369 (0.0%)

Chiral center outliers are detected by calculating the chiral volume of a chiral center and verifying if the center is modelled as a planar moiety or with the opposite hand. A planarity outlier is detected by checking planarity of atoms in a peptide group, atoms in a mainchain group or atoms of a sidechain that are expected to be planar.

Mol	Chain	#Chirality outliers	#Planarity outliers
33	l	0	1

All (3) bond length outliers are listed below:

Mol	Chain	Res	Type	Atoms	Z	Observed(Å)	Ideal(Å)
54	6	1	C	OP3-P	-10.57	1.48	1.61
53	5	1	G	OP3-P	-10.47	1.48	1.61
11	K	120	GLY	N-CA	-7.06	1.35	1.46

All (21) bond angle outliers are listed below:

Mol	Chain	Res	Type	Atoms	Z	Observed(°)	Ideal(°)
1	A	659	U	C2-N3-C4	-9.65	121.21	127.00
22	a	512	G	O4'-C1'-N9	9.40	115.72	108.20
1	A	412	A	O4'-C1'-N9	6.62	113.50	108.20
53	5	43	C	N1-C2-O2	6.62	122.87	118.90
22	a	748	G	O4'-C1'-N9	6.60	113.48	108.20
1	A	659	U	N1-C2-N3	6.24	118.64	114.90
22	a	704	G	O4'-C1'-N9	6.06	113.05	108.20
54	6	71	G	N3-C2-N2	-6.00	115.70	119.90
1	A	659	U	N3-C4-C5	5.95	118.17	114.60
22	a	1313	U	C2-N1-C1'	5.84	124.71	117.70
54	6	71	G	N1-C6-O6	-5.83	116.40	119.90
54	6	52	C	C2-N1-C1'	5.82	125.21	118.80
53	5	43	C	C2-N1-C1'	5.64	125.00	118.80
1	A	659	U	N3-C2-O2	-5.40	118.42	122.20
22	a	2848	G	O4'-C1'-N9	5.38	112.51	108.20
1	A	307	C	C2-N1-C1'	5.24	124.57	118.80
54	6	52	C	C6-N1-C1'	-5.17	114.60	120.80
2	B	10	LEU	CA-CB-CG	5.11	127.06	115.30
22	a	481	G	O4'-C1'-N9	5.10	112.28	108.20
22	a	729	G	O4'-C1'-N9	5.05	112.24	108.20
22	a	2506	U	C2-N1-C1'	5.01	123.71	117.70

There are no chirality outliers.

All (1) planarity outliers are listed below:

Mol	Chain	Res	Type	Group
33	l	81	4D4	Mainchain

5.2 Too-close contacts [\(i\)](#)

Due to software issues we are unable to calculate clashes - this section is therefore empty.

5.3 Torsion angles [\(i\)](#)

5.3.1 Protein backbone [\(i\)](#)

In the following table, the Percentiles column shows the percent Ramachandran outliers of the chain as a percentile score with respect to all PDB entries followed by that with respect to all EM entries.

The Analysed column shows the number of residues for which the backbone conformation was analysed, and the total number of residues.

Mol	Chain	Analysed	Favoured	Allowed	Outliers	Percentiles	
2	B	222/241 (92%)	212 (96%)	10 (4%)	0	100	100
3	C	204/233 (88%)	194 (95%)	10 (5%)	0	100	100
4	D	203/206 (98%)	201 (99%)	2 (1%)	0	100	100
5	E	154/167 (92%)	150 (97%)	4 (3%)	0	100	100
6	F	101/135 (75%)	95 (94%)	6 (6%)	0	100	100
7	G	151/179 (84%)	142 (94%)	9 (6%)	0	100	100
8	H	127/130 (98%)	120 (94%)	7 (6%)	0	100	100
9	I	125/130 (96%)	121 (97%)	4 (3%)	0	100	100
10	J	96/103 (93%)	91 (95%)	4 (4%)	1 (1%)	15	16
11	K	113/129 (88%)	109 (96%)	4 (4%)	0	100	100
12	L	120/124 (97%)	117 (98%)	3 (2%)	0	100	100
13	M	113/118 (96%)	109 (96%)	4 (4%)	0	100	100
14	N	98/101 (97%)	94 (96%)	4 (4%)	0	100	100
15	O	86/89 (97%)	83 (96%)	3 (4%)	0	100	100
16	P	79/82 (96%)	75 (95%)	4 (5%)	0	100	100
17	Q	77/84 (92%)	76 (99%)	1 (1%)	0	100	100
18	R	64/75 (85%)	60 (94%)	4 (6%)	0	100	100
19	S	82/92 (89%)	79 (96%)	3 (4%)	0	100	100
20	T	84/87 (97%)	82 (98%)	2 (2%)	0	100	100
21	U	68/71 (96%)	67 (98%)	1 (2%)	0	100	100
24	c	269/273 (98%)	264 (98%)	5 (2%)	0	100	100
25	d	206/209 (99%)	201 (98%)	5 (2%)	0	100	100
26	e	199/201 (99%)	197 (99%)	2 (1%)	0	100	100
27	f	175/179 (98%)	168 (96%)	7 (4%)	0	100	100
28	g	174/177 (98%)	160 (92%)	12 (7%)	2 (1%)	14	15
29	h	39/149 (26%)	34 (87%)	5 (13%)	0	100	100
30	i	140/142 (99%)	140 (100%)	0	0	100	100
31	j	121/123 (98%)	118 (98%)	3 (2%)	0	100	100
32	k	142/144 (99%)	137 (96%)	5 (4%)	0	100	100
33	l	132/136 (97%)	130 (98%)	2 (2%)	0	100	100
34	m	116/127 (91%)	111 (96%)	5 (4%)	0	100	100
35	n	114/117 (97%)	110 (96%)	4 (4%)	0	100	100

Continued on next page...

Continued from previous page...

Mol	Chain	Analysed	Favoured	Allowed	Outliers	Percentiles	
36	o	112/115 (97%)	109 (97%)	3 (3%)	0	100	100
37	p	115/118 (98%)	115 (100%)	0	0	100	100
38	q	101/103 (98%)	97 (96%)	4 (4%)	0	100	100
39	r	108/110 (98%)	104 (96%)	4 (4%)	0	100	100
40	s	91/100 (91%)	89 (98%)	2 (2%)	0	100	100
41	t	100/104 (96%)	93 (93%)	7 (7%)	0	100	100
42	u	92/94 (98%)	88 (96%)	4 (4%)	0	100	100
43	v	76/85 (89%)	74 (97%)	2 (3%)	0	100	100
44	w	75/78 (96%)	75 (100%)	0	0	100	100
45	x	60/63 (95%)	57 (95%)	3 (5%)	0	100	100
46	y	56/59 (95%)	54 (96%)	2 (4%)	0	100	100
47	z	54/57 (95%)	52 (96%)	2 (4%)	0	100	100
48	0	49/55 (89%)	49 (100%)	0	0	100	100
49	1	44/46 (96%)	44 (100%)	0	0	100	100
50	2	62/65 (95%)	60 (97%)	2 (3%)	0	100	100
51	3	36/38 (95%)	36 (100%)	0	0	100	100
52	4	56/70 (80%)	52 (93%)	4 (7%)	0	100	100
All	All	5481/5913 (93%)	5295 (97%)	183 (3%)	3 (0%)	54	64

All (3) Ramachandran outliers are listed below:

Mol	Chain	Res	Type
10	J	57	VAL
28	g	47	ASP
28	g	46	ALA

5.3.2 Protein sidechains [i](#)

In the following table, the Percentiles column shows the percent sidechain outliers of the chain as a percentile score with respect to all PDB entries followed by that with respect to all EM entries.

The Analysed column shows the number of residues for which the sidechain conformation was analysed, and the total number of residues.

Mol	Chain	Analysed	Rotameric	Outliers	Percentiles	
2	B	186/199 (94%)	171 (92%)	15 (8%)	11	13
3	C	170/190 (90%)	159 (94%)	11 (6%)	17	21
4	D	172/173 (99%)	163 (95%)	9 (5%)	23	31
5	E	119/126 (94%)	109 (92%)	10 (8%)	11	12
6	F	90/116 (78%)	84 (93%)	6 (7%)	16	20
7	G	126/147 (86%)	121 (96%)	5 (4%)	31	41
8	H	104/105 (99%)	102 (98%)	2 (2%)	57	69
9	I	105/107 (98%)	102 (97%)	3 (3%)	42	54
10	J	86/90 (96%)	85 (99%)	1 (1%)	71	81
11	K	89/98 (91%)	87 (98%)	2 (2%)	52	64
12	L	102/103 (99%)	98 (96%)	4 (4%)	32	42
13	M	93/96 (97%)	88 (95%)	5 (5%)	22	29
14	N	83/84 (99%)	83 (100%)	0	100	100
15	O	76/77 (99%)	73 (96%)	3 (4%)	32	42
16	P	65/65 (100%)	64 (98%)	1 (2%)	65	76
17	Q	73/78 (94%)	69 (94%)	4 (6%)	21	28
18	R	57/65 (88%)	56 (98%)	1 (2%)	59	71
19	S	72/79 (91%)	70 (97%)	2 (3%)	43	56
20	T	65/66 (98%)	62 (95%)	3 (5%)	27	35
21	U	60/61 (98%)	55 (92%)	5 (8%)	11	12
24	c	216/218 (99%)	210 (97%)	6 (3%)	43	56
25	d	163/163 (100%)	156 (96%)	7 (4%)	29	38
26	e	165/165 (100%)	162 (98%)	3 (2%)	59	71
27	f	148/150 (99%)	136 (92%)	12 (8%)	11	13
28	g	137/138 (99%)	130 (95%)	7 (5%)	24	31
29	h	32/114 (28%)	32 (100%)	0	100	100
30	i	116/116 (100%)	111 (96%)	5 (4%)	29	38
31	j	104/104 (100%)	100 (96%)	4 (4%)	33	43
32	k	103/103 (100%)	98 (95%)	5 (5%)	25	33
33	l	107/107 (100%)	105 (98%)	2 (2%)	57	69
34	m	98/103 (95%)	96 (98%)	2 (2%)	55	67
35	n	86/87 (99%)	84 (98%)	2 (2%)	50	63

Continued on next page...

Continued from previous page...

Mol	Chain	Analysed	Rotameric	Outliers	Percentiles	
36	o	99/100 (99%)	94 (95%)	5 (5%)	24	31
37	p	89/90 (99%)	88 (99%)	1 (1%)	73	83
38	q	84/84 (100%)	81 (96%)	3 (4%)	35	46
39	r	93/93 (100%)	89 (96%)	4 (4%)	29	38
40	s	80/84 (95%)	78 (98%)	2 (2%)	47	60
41	t	83/85 (98%)	79 (95%)	4 (5%)	25	34
42	u	78/78 (100%)	75 (96%)	3 (4%)	33	43
43	v	58/63 (92%)	57 (98%)	1 (2%)	60	73
44	w	67/68 (98%)	66 (98%)	1 (2%)	65	76
45	x	54/55 (98%)	54 (100%)	0	100	100
46	y	48/49 (98%)	46 (96%)	2 (4%)	30	39
47	z	47/48 (98%)	45 (96%)	2 (4%)	29	38
48	0	46/49 (94%)	45 (98%)	1 (2%)	52	64
49	1	38/38 (100%)	36 (95%)	2 (5%)	22	30
50	2	51/52 (98%)	49 (96%)	2 (4%)	32	42
51	3	34/34 (100%)	32 (94%)	2 (6%)	19	25
52	4	55/62 (89%)	52 (94%)	3 (6%)	21	28
All	All	4572/4825 (95%)	4387 (96%)	185 (4%)	35	41

All (185) residues with a non-rotameric sidechain are listed below:

Mol	Chain	Res	Type
2	B	6	MET
2	B	21	ARG
2	B	23	TRP
2	B	49	MET
2	B	74	ARG
2	B	88	ASP
2	B	90	PHE
2	B	110	SER
2	B	118	GLU
2	B	127	ASP
2	B	131	LYS
2	B	139	ARG
2	B	147	SER
2	B	188	ASP

Continued on next page...

Continued from previous page...

Mol	Chain	Res	Type
2	B	194	ASP
3	C	16	LYS
3	C	20	SER
3	C	31	ASP
3	C	49	LYS
3	C	54	ARG
3	C	79	LYS
3	C	86	LYS
3	C	93	ASP
3	C	114	LYS
3	C	185	ASN
3	C	206	GLU
4	D	8	LYS
4	D	14	ARG
4	D	29	ASP
4	D	63	ARG
4	D	78	GLU
4	D	104	ARG
4	D	128	ARG
4	D	154	ARG
4	D	179	GLU
5	E	22	SER
5	E	48	PHE
5	E	62	LYS
5	E	73	ASN
5	E	92	SER
5	E	112	ARG
5	E	145	GLU
5	E	147	MET
5	E	156	LYS
5	E	159	LYS
6	F	8	PHE
6	F	15	SER
6	F	46	GLN
6	F	63	ASN
6	F	93	LYS
6	F	102	MET
7	G	5	ARG
7	G	113	ASP
7	G	119	ARG
7	G	138	ARG
7	G	143	ARG

Continued on next page...

Continued from previous page...

Mol	Chain	Res	Type
8	H	41	LYS
8	H	94	LYS
9	I	14	SER
9	I	100	LYS
9	I	123	ARG
10	J	27	GLU
11	K	17	SER
11	K	85	MET
12	L	10	LYS
12	L	15	LYS
12	L	51	LYS
12	L	62	GLU
13	M	11	ASP
13	M	16	VAL
13	M	49	SER
13	M	78	LYS
13	M	82	ASP
15	O	14	GLU
15	O	26	GLU
15	O	61	SER
16	P	24	SER
17	Q	40	ARG
17	Q	42	THR
17	Q	50	ASN
17	Q	77	ARG
18	R	42	SER
19	S	29	LYS
19	S	64	ASP
20	T	9	LYS
20	T	26	SER
20	T	54	MET
21	U	17	ARG
21	U	24	GLU
21	U	34	ARG
21	U	36	GLU
21	U	51	SER
24	c	5	LYS
24	c	18	LYS
24	c	133	ARG
24	c	183	LYS
24	c	242	LYS
24	c	272	SER

Continued on next page...

Continued from previous page...

Mol	Chain	Res	Type
25	d	21	SER
25	d	59	ARG
25	d	88	GLU
25	d	95	SER
25	d	105	LYS
25	d	110	THR
25	d	183	GLU
26	e	116	ASP
26	e	127	GLU
26	e	168	ASP
27	f	3	LYS
27	f	5	HIS
27	f	24	SER
27	f	42	GLU
27	f	69	LYS
27	f	78	LYS
27	f	88	LYS
27	f	121	SER
27	f	125	ARG
27	f	129	SER
27	f	153	ASP
27	f	163	ASP
28	g	3	ARG
28	g	18	LYS
28	g	29	LYS
28	g	39	ASP
28	g	42	GLU
28	g	152	ARG
28	g	175	LYS
30	i	12	LYS
30	i	37	ARG
30	i	69	ARG
30	i	95	ARG
30	i	96	ARG
31	j	49	ARG
31	j	67	LYS
31	j	108	ARG
31	j	117	SER
32	k	1	MET
32	k	2	ARG
32	k	40	SER
32	k	129	LYS

Continued on next page...

Continued from previous page...

Mol	Chain	Res	Type
32	k	144	GLU
33	l	6	ARG
33	l	8	LYS
34	m	15	SER
34	m	78	LYS
35	n	56	LYS
35	n	89	ASP
36	o	19	SER
36	o	53	ARG
36	o	63	LYS
36	o	85	SER
36	o	103	ARG
37	p	97	ASP
38	q	26	ASP
38	q	55	ASP
38	q	102	SER
39	r	7	HIS
39	r	27	LYS
39	r	83	LYS
39	r	95	ARG
40	s	64	LYS
40	s	69	ARG
41	t	6	ARG
41	t	46	GLN
41	t	54	GLN
41	t	99	ASN
42	u	46	LYS
42	u	68	LYS
42	u	75	GLN
43	v	64	ASP
44	w	44	LYS
46	y	19	LYS
46	y	31	ARG
47	z	12	LYS
47	z	34	SER
48	0	28	ARG
49	1	8	SER
49	1	25	LYS
50	2	23	LYS
50	2	31	HIS
51	3	12	ARG
51	3	30	GLU

Continued on next page...

Continued from previous page...

Mol	Chain	Res	Type
52	4	1	MET
52	4	17	SER
52	4	63	ARG

Sometimes sidechains can be flipped to improve hydrogen bonding and reduce clashes. All (9) such sidechains are listed below:

Mol	Chain	Res	Type
2	B	42	ASN
2	B	168	HIS
4	D	54	GLN
18	R	74	HIS
20	T	13	GLN
20	T	61	GLN
26	e	115	GLN
44	w	17	ASN
45	x	58	ASN

5.3.3 RNA [i](#)

Mol	Chain	Analysed	Backbone Outliers	Pucker Outliers
1	A	1513/1542 (98%)	207 (13%)	5 (0%)
22	a	2745/2904 (94%)	301 (10%)	0
23	b	118/120 (98%)	12 (10%)	0
53	5	74/76 (97%)	17 (22%)	2 (2%)
54	6	76/77 (98%)	16 (21%)	0
55	7	9/10 (90%)	0	0
All	All	4535/4729 (95%)	553 (12%)	7 (0%)

All (553) RNA backbone outliers are listed below:

Mol	Chain	Res	Type
1	A	4	U
1	A	5	U
1	A	6	G
1	A	9	G
1	A	13	U
1	A	32	A
1	A	39	G
1	A	47	C
1	A	48	C

Continued on next page...

Continued from previous page...

Mol	Chain	Res	Type
1	A	50	A
1	A	51	A
1	A	70	U
1	A	71	A
1	A	74	A
1	A	80	A
1	A	83	C
1	A	84	U
1	A	86	G
1	A	87	C
1	A	88	U
1	A	89	U
1	A	95	C
1	A	121	U
1	A	122	G
1	A	130	A
1	A	131	A
1	A	141	G
1	A	143	A
1	A	144	G
1	A	151	A
1	A	159	G
1	A	163	C
1	A	167	A
1	A	173	U
1	A	182	A
1	A	183	C
1	A	184	G
1	A	197	A
1	A	200	G
1	A	201	G
1	A	204	G
1	A	240	G
1	A	245	U
1	A	247	G
1	A	251	G
1	A	266	G
1	A	267	C
1	A	280	C
1	A	289	G
1	A	306	A
1	A	321	A

Continued on next page...

Continued from previous page...

Mol	Chain	Res	Type
1	A	328	C
1	A	329	A
1	A	346	G
1	A	347	G
1	A	348	G
1	A	352	C
1	A	354	G
1	A	367	U
1	A	372	C
1	A	373	A
1	A	384	G
1	A	398	U
1	A	406	G
1	A	412	A
1	A	413	G
1	A	414	A
1	A	417	G
1	A	421	U
1	A	422	C
1	A	423	G
1	A	424	G
1	A	429	U
1	A	436	C
1	A	439	U
1	A	446	G
1	A	453	G
1	A	457	G
1	A	458	U
1	A	465	A
1	A	467	U
1	A	468	A
1	A	469	C
1	A	478	A
1	A	479	U
1	A	481	G
1	A	482	A
1	A	484	G
1	A	486	U
1	A	495	A
1	A	496	A
1	A	497	G
1	A	509	A

Continued on next page...

Continued from previous page...

Mol	Chain	Res	Type
1	A	511	C
1	A	518	C
1	A	531	U
1	A	532	A
1	A	547	A
1	A	559	A
1	A	564	C
1	A	572	A
1	A	573	A
1	A	576	C
1	A	620	C
1	A	633	G
1	A	653	U
1	A	665	A
1	A	723	U
1	A	724	G
1	A	733	G
1	A	747	A
1	A	755	G
1	A	777	A
1	A	793	U
1	A	794	A
1	A	814	A
1	A	815	A
1	A	817	C
1	A	890	G
1	A	902	G
1	A	914	A
1	A	926	G
1	A	934	C
1	A	935	A
1	A	960	U
1	A	966	2MG
1	A	969	A
1	A	971	G
1	A	975	A
1	A	976	G
1	A	977	A
1	A	989	U
1	A	992	U
1	A	993	G
1	A	994	A

Continued on next page...

Continued from previous page...

Mol	Chain	Res	Type
1	A	1003	G
1	A	1004	A
1	A	1009	U
1	A	1022	A
1	A	1024	G
1	A	1027	C
1	A	1029	U
1	A	1030	U
1	A	1031	C
1	A	1033	G
1	A	1034	G
1	A	1036	A
1	A	1037	C
1	A	1039	G
1	A	1044	A
1	A	1046	A
1	A	1065	U
1	A	1070	U
1	A	1085	U
1	A	1094	G
1	A	1095	U
1	A	1101	A
1	A	1127	G
1	A	1137	C
1	A	1139	G
1	A	1159	U
1	A	1196	A
1	A	1197	A
1	A	1213	A
1	A	1227	A
1	A	1228	C
1	A	1238	A
1	A	1257	A
1	A	1258	G
1	A	1275	A
1	A	1280	A
1	A	1286	U
1	A	1287	A
1	A	1300	G
1	A	1302	C
1	A	1305	G
1	A	1317	C

Continued on next page...

Continued from previous page...

Mol	Chain	Res	Type
1	A	1320	C
1	A	1338	G
1	A	1346	A
1	A	1353	G
1	A	1363	A
1	A	1364	U
1	A	1370	G
1	A	1378	C
1	A	1379	G
1	A	1381	U
1	A	1383	C
1	A	1397	C
1	A	1398	A
1	A	1419	G
1	A	1432	G
1	A	1441	A
1	A	1445	U
1	A	1446	A
1	A	1447	A
1	A	1451	U
1	A	1452	C
1	A	1453	G
1	A	1487	G
1	A	1492	A
1	A	1497	G
1	A	1503	A
1	A	1506	U
1	A	1517	G
1	A	1529	G
1	A	1530	G
22	a	10	A
22	a	12	U
22	a	14	A
22	a	15	G
22	a	34	U
22	a	42	A
22	a	50	U
22	a	71	A
22	a	74	A
22	a	75	G
22	a	101	A
22	a	102	U

Continued on next page...

Continued from previous page...

Mol	Chain	Res	Type
22	a	118	A
22	a	119	A
22	a	120	U
22	a	125	A
22	a	139	U
22	a	142	A
22	a	163	C
22	a	164	C
22	a	181	A
22	a	196	A
22	a	215	G
22	a	216	A
22	a	221	A
22	a	222	A
22	a	248	G
22	a	265	A
22	a	272	A
22	a	277	G
22	a	278	A
22	a	279	A
22	a	281	C
22	a	289	G
22	a	294	A
22	a	311	A
22	a	329	G
22	a	330	A
22	a	355	U
22	a	357	C
22	a	361	G
22	a	362	A
22	a	386	G
22	a	396	G
22	a	405	U
22	a	411	G
22	a	481	G
22	a	489	G
22	a	491	G
22	a	504	A
22	a	505	A
22	a	508	A
22	a	509	C
22	a	530	G

Continued on next page...

Continued from previous page...

Mol	Chain	Res	Type
22	a	531	C
22	a	532	A
22	a	545	U
22	a	546	U
22	a	548	G
22	a	549	G
22	a	563	A
22	a	573	U
22	a	575	A
22	a	603	A
22	a	614	A
22	a	615	U
22	a	627	A
22	a	637	A
22	a	645	C
22	a	647	G
22	a	653	U
22	a	654	A
22	a	655	A
22	a	686	U
22	a	717	C
22	a	730	A
22	a	738	G
22	a	747	5MU
22	a	764	A
22	a	775	G
22	a	776	G
22	a	782	A
22	a	784	G
22	a	785	G
22	a	805	G
22	a	812	C
22	a	827	U
22	a	828	U
22	a	845	A
22	a	846	U
22	a	847	U
22	a	859	G
22	a	869	G
22	a	879	G
22	a	881	G
22	a	883	G

Continued on next page...

Continued from previous page...

Mol	Chain	Res	Type
22	a	884	U
22	a	890	C
22	a	891	G
22	a	895	U
22	a	896	A
22	a	897	C
22	a	910	A
22	a	914	G
22	a	915	C
22	a	927	A
22	a	931	U
22	a	934	U
22	a	946	C
22	a	961	C
22	a	974	G
22	a	983	A
22	a	996	A
22	a	1005	C
22	a	1012	U
22	a	1013	C
22	a	1033	U
22	a	1045	C
22	a	1047	G
22	a	1110	G
22	a	1111	A
22	a	1112	G
22	a	1116	G
22	a	1122	G
22	a	1128	G
22	a	1132	U
22	a	1133	A
22	a	1135	C
22	a	1136	G
22	a	1142	A
22	a	1168	G
22	a	1171	G
22	a	1253	A
22	a	1256	G
22	a	1271	G
22	a	1272	A
22	a	1300	G
22	a	1301	A

Continued on next page...

Continued from previous page...

Mol	Chain	Res	Type
22	a	1329	U
22	a	1352	U
22	a	1365	A
22	a	1379	U
22	a	1380	G
22	a	1383	A
22	a	1409	U
22	a	1416	G
22	a	1419	A
22	a	1420	A
22	a	1428	C
22	a	1452	G
22	a	1453	A
22	a	1460	U
22	a	1475	G
22	a	1482	G
22	a	1483	G
22	a	1493	C
22	a	1497	U
22	a	1509	A
22	a	1510	G
22	a	1515	A
22	a	1524	G
22	a	1529	G
22	a	1534	U
22	a	1536	C
22	a	1537	G
22	a	1540	G
22	a	1566	A
22	a	1569	A
22	a	1578	U
22	a	1583	A
22	a	1585	C
22	a	1608	A
22	a	1616	A
22	a	1647	U
22	a	1648	U
22	a	1649	G
22	a	1674	G
22	a	1715	G
22	a	1729	U
22	a	1730	C

Continued on next page...

Continued from previous page...

Mol	Chain	Res	Type
22	a	1733	G
22	a	1738	G
22	a	1739	A
22	a	1744	A
22	a	1764	C
22	a	1773	A
22	a	1782	U
22	a	1791	A
22	a	1800	C
22	a	1801	A
22	a	1808	A
22	a	1816	C
22	a	1829	A
22	a	1847	A
22	a	1848	A
22	a	1857	G
22	a	1858	A
22	a	1870	C
22	a	1871	A
22	a	1872	A
22	a	1873	G
22	a	1906	G
22	a	1929	G
22	a	1930	G
22	a	1937	A
22	a	1938	A
22	a	1955	U
22	a	1965	C
22	a	1967	C
22	a	1970	A
22	a	1971	U
22	a	1972	G
22	a	1991	U
22	a	1993	U
22	a	2023	C
22	a	2031	A
22	a	2033	A
22	a	2043	C
22	a	2055	C
22	a	2056	G
22	a	2060	A
22	a	2061	G

Continued on next page...

Continued from previous page...

Mol	Chain	Res	Type
22	a	2062	A
22	a	2069	G7M
22	a	2098	U
22	a	2198	A
22	a	2204	G
22	a	2211	A
22	a	2225	A
22	a	2238	G
22	a	2268	A
22	a	2279	G
22	a	2283	C
22	a	2287	A
22	a	2305	U
22	a	2308	G
22	a	2322	A
22	a	2335	A
22	a	2336	A
22	a	2347	C
22	a	2361	G
22	a	2377	A
22	a	2383	G
22	a	2385	C
22	a	2402	U
22	a	2406	A
22	a	2425	A
22	a	2429	G
22	a	2430	A
22	a	2435	A
22	a	2441	U
22	a	2445	2MG
22	a	2448	A
22	a	2474	U
22	a	2476	A
22	a	2482	A
22	a	2491	U
22	a	2494	G
22	a	2502	G
22	a	2505	G
22	a	2518	A
22	a	2529	G
22	a	2547	A
22	a	2566	A

Continued on next page...

Continued from previous page...

Mol	Chain	Res	Type
22	a	2567	G
22	a	2573	C
22	a	2586	U
22	a	2602	A
22	a	2609	U
22	a	2613	U
22	a	2615	U
22	a	2629	U
22	a	2630	G
22	a	2646	C
22	a	2661	G
22	a	2663	G
22	a	2689	U
22	a	2690	U
22	a	2707	U
22	a	2714	G
22	a	2726	A
22	a	2733	A
22	a	2744	G
22	a	2748	A
22	a	2752	C
22	a	2757	A
22	a	2765	A
22	a	2778	A
22	a	2790	U
22	a	2791	G
22	a	2793	C
22	a	2796	U
22	a	2798	U
22	a	2800	A
22	a	2820	A
22	a	2821	A
22	a	2835	A
22	a	2873	A
22	a	2884	U
22	a	2891	U
22	a	2899	A
23	b	13	G
23	b	34	A
23	b	35	C
23	b	36	C
23	b	45	A

Continued on next page...

Continued from previous page...

Mol	Chain	Res	Type
23	b	56	G
23	b	66	A
23	b	67	G
23	b	89	U
23	b	90	C
23	b	99	A
23	b	109	A
53	5	2	C
53	5	5	G
53	5	9	A
53	5	16	U
53	5	18	G
53	5	19	G
53	5	20	U
53	5	21	A
53	5	22	G
53	5	44	G
53	5	45	U
53	5	46	G7M
53	5	47	U
53	5	48	C
53	5	58	A
53	5	69	G
53	5	74	C
54	6	9	G
54	6	17	C
54	6	18	U
54	6	19	G
54	6	20	G
54	6	21	H2U
54	6	22	A
54	6	23	G
54	6	49	C
54	6	50	G
54	6	51	U
54	6	53	G
54	6	54	G
54	6	59	A
54	6	68	C
54	6	77	A

All (7) RNA pucker outliers are listed below:

Mol	Chain	Res	Type
1	A	5	U
1	A	120	A
1	A	467	U
1	A	1026	G
1	A	1035	A
53	5	8	4SU
53	5	21	A

5.4 Non-standard residues in protein, DNA, RNA chains [i](#)

51 non-standard protein/DNA/RNA residues are modelled in this entry.

In the following table, the Counts columns list the number of bonds (or angles) for which Mogul statistics could be retrieved, the number of bonds (or angles) that are observed in the model and the number of bonds (or angles) that are defined in the Chemical Component Dictionary. The Link column lists molecule types, if any, to which the group is linked. The Z score for a bond length (or angle) is the number of standard deviations the observed value is removed from the expected value. A bond length (or angle) with $|Z| > 2$ is considered an outlier worth inspection. RMSZ is the root-mean-square of all Z scores of the bond lengths (or angles).

Mol	Type	Chain	Res	Link	Bond lengths			Bond angles		
					Counts	RMSZ	# Z > 2	Counts	RMSZ	# Z > 2
54	5MU	6	55	54	19,22,23	0.43	0	28,32,35	0.71	0
25	MEQ	d	150	25	8,9,10	0.89	0	5,10,12	0.71	0
1	2MG	A	966	1	18,26,27	1.27	2 (11%)	16,38,41	0.91	0
53	4SU	5	8	53	18,21,22	3.62	8 (44%)	26,30,33	2.28	5 (19%)
22	5MU	a	1939	22	19,22,23	0.62	0	28,32,35	0.56	0
22	G7M	a	2069	22	20,26,27	2.59	7 (35%)	17,39,42	1.07	1 (5%)
1	PSU	A	516	1,56	18,21,22	1.09	1 (5%)	22,30,33	1.73	4 (18%)
1	UR3	A	1498	1,56	19,22,23	2.66	7 (36%)	26,32,35	1.39	2 (7%)
1	5MC	A	967	1	18,22,23	0.65	0	26,32,35	0.55	0
53	PSU	5	32	53	18,21,22	1.04	1 (5%)	22,30,33	1.79	5 (22%)
1	2MG	A	1207	1	18,26,27	1.20	3 (16%)	16,38,41	0.90	1 (6%)
1	MA6	A	1518	1	18,26,27	1.06	1 (5%)	19,38,41	1.29	3 (15%)
22	2MG	a	2445	26,22	18,26,27	1.32	3 (16%)	16,38,41	0.83	1 (6%)
33	4D4	l	81	33	9,11,12	1.91	2 (22%)	8,13,15	2.37	4 (50%)
53	5MU	5	54	53	19,22,23	0.51	0	28,32,35	0.59	0
22	2MA	a	2503	22,56	17,25,26	2.24	4 (23%)	17,37,40	1.33	2 (11%)
22	PSU	a	2580	22,56	18,21,22	1.14	2 (11%)	22,30,33	1.83	6 (27%)
22	1MG	a	745	22	18,26,27	2.49	6 (33%)	19,39,42	1.50	4 (21%)
22	PSU	a	2457	22,56	18,21,22	1.11	1 (5%)	22,30,33	1.95	6 (27%)

Mol	Type	Chain	Res	Link	Bond lengths			Bond angles		
					Counts	RMSZ	# Z > 2	Counts	RMSZ	# Z > 2
22	PSU	a	1911	22	18,21,22	1.09	1 (5%)	22,30,33	1.81	5 (22%)
53	MIA	5	37	53	24,31,32	1.43	3 (12%)	26,44,47	2.23	7 (26%)
12	D2T	L	89	12	7,9,10	1.40	1 (14%)	6,11,13	2.29	3 (50%)
22	PSU	a	1917	22	18,21,22	1.05	1 (5%)	22,30,33	1.84	3 (13%)
22	PSU	a	2605	22	18,21,22	1.08	1 (5%)	22,30,33	1.85	4 (18%)
53	PSU	5	39	53	18,21,22	0.96	1 (5%)	22,30,33	1.74	3 (13%)
22	OMC	a	2498	22,56	19,22,23	0.69	0	26,31,34	0.69	0
22	6MZ	a	1618	22	18,25,26	1.95	3 (16%)	16,36,39	2.10	3 (18%)
54	4SU	6	8	54	18,21,22	3.65	7 (38%)	26,30,33	2.32	5 (19%)
22	H2U	a	2449	22	18,21,22	0.58	0	21,30,33	0.98	1 (4%)
22	PSU	a	955	22	18,21,22	1.02	1 (5%)	22,30,33	1.86	4 (18%)
53	PSU	5	55	53	18,21,22	1.01	1 (5%)	22,30,33	1.91	5 (22%)
11	IAS	K	119	11,21	6,7,8	1.34	0	6,8,10	1.24	0
22	5MC	a	1962	22	18,22,23	0.69	0	26,32,35	0.58	0
1	2MG	A	1516	1	18,26,27	1.22	3 (16%)	16,38,41	0.85	1 (6%)
22	OMU	a	2552	22	19,22,23	2.75	6 (31%)	26,31,34	1.81	5 (19%)
54	OMC	6	33	54	19,22,23	0.59	0	26,31,34	0.74	1 (3%)
22	6MZ	a	2030	22	18,25,26	1.91	2 (11%)	16,36,39	2.59	3 (18%)
54	PSU	6	56	54	18,21,22	1.06	1 (5%)	22,30,33	1.67	4 (18%)
22	PSU	a	746	22,56	18,21,22	1.04	1 (5%)	22,30,33	1.74	3 (13%)
22	3TD	a	1915	22	19,22,23	4.29	8 (42%)	21,32,35	2.11	6 (28%)
1	4OC	A	1402	1	20,23,24	3.00	8 (40%)	26,32,35	0.91	1 (3%)
1	MA6	A	1519	1	18,26,27	1.00	1 (5%)	19,38,41	1.46	4 (21%)
22	PSU	a	2604	22	18,21,22	1.04	1 (5%)	22,30,33	1.83	3 (13%)
1	5MC	A	1407	1	18,22,23	0.75	0	26,32,35	0.53	0
22	2MG	a	1835	22	18,26,27	1.24	3 (16%)	16,38,41	0.88	1 (6%)
22	OMG	a	2251	54,22,56	18,26,27	1.28	3 (16%)	19,38,41	0.78	1 (5%)
53	G7M	5	46	53	20,26,27	2.78	8 (40%)	17,39,42	1.17	2 (11%)
22	5MU	a	747	22	19,22,23	0.61	0	28,32,35	0.49	0
22	PSU	a	2504	22	18,21,22	1.09	1 (5%)	22,30,33	1.71	4 (18%)
1	G7M	A	527	1	20,26,27	2.68	7 (35%)	17,39,42	1.07	1 (5%)
54	H2U	6	21	54	18,21,22	0.44	0	21,30,33	1.04	1 (4%)

In the following table, the Chirals column lists the number of chiral outliers, the number of chiral centers analysed, the number of these observed in the model and the number defined in the Chemical Component Dictionary. Similar counts are reported in the Torsion and Rings columns. '-' means no outliers of that kind were identified.

Mol	Type	Chain	Res	Link	Chirals	Torsions	Rings
54	5MU	6	55	54	-	0/7/25/26	0/2/2/2
25	MEQ	d	150	25	-	4/8/9/11	-
1	2MG	A	966	1	-	2/5/27/28	0/3/3/3
53	4SU	5	8	53	-	0/7/25/26	0/2/2/2
22	5MU	a	1939	22	-	0/7/25/26	0/2/2/2
22	G7M	a	2069	22	-	2/3/25/26	0/3/3/3
1	PSU	A	516	1,56	-	0/7/25/26	0/2/2/2
1	UR3	A	1498	1,56	-	0/7/25/26	0/2/2/2
1	5MC	A	967	1	-	0/7/25/26	0/2/2/2
53	PSU	5	32	53	-	0/7/25/26	0/2/2/2
1	2MG	A	1207	1	-	0/5/27/28	0/3/3/3
1	MA6	A	1518	1	-	1/7/29/30	0/3/3/3
22	2MG	a	2445	26,22	-	2/5/27/28	0/3/3/3
33	4D4	l	81	33	-	0/11/12/14	-
53	5MU	5	54	53	-	0/7/25/26	0/2/2/2
22	2MA	a	2503	22,56	-	2/3/25/26	0/3/3/3
22	PSU	a	2580	22,56	-	0/7/25/26	0/2/2/2
22	1MG	a	745	22	-	0/3/25/26	0/3/3/3
22	PSU	a	2457	22,56	-	0/7/25/26	0/2/2/2
22	PSU	a	1911	22	-	0/7/25/26	0/2/2/2
53	MIA	5	37	53	-	6/11/33/34	0/3/3/3
12	D2T	L	89	12	-	2/7/12/14	-
22	PSU	a	1917	22	-	0/7/25/26	0/2/2/2
22	PSU	a	2605	22	-	0/7/25/26	0/2/2/2
53	PSU	5	39	53	-	0/7/25/26	0/2/2/2
22	OMC	a	2498	22,56	-	0/9/27/28	0/2/2/2
22	6MZ	a	1618	22	-	0/5/27/28	0/3/3/3
54	4SU	6	8	54	-	0/7/25/26	0/2/2/2
22	H2U	a	2449	22	-	1/7/38/39	0/2/2/2
22	PSU	a	955	22	-	0/7/25/26	0/2/2/2
53	PSU	5	55	53	-	0/7/25/26	0/2/2/2
11	IAS	K	119	11,21	-	3/7/7/8	-
22	5MC	a	1962	22	-	0/7/25/26	0/2/2/2
1	2MG	A	1516	1	-	0/5/27/28	0/3/3/3
22	OMU	a	2552	22	-	0/9/27/28	0/2/2/2
54	OMC	6	33	54	-	1/9/27/28	0/2/2/2
22	6MZ	a	2030	22	-	2/5/27/28	0/3/3/3
54	PSU	6	56	54	-	2/7/25/26	0/2/2/2
22	PSU	a	746	22,56	-	1/7/25/26	0/2/2/2
22	3TD	a	1915	22	-	0/7/25/26	0/2/2/2
1	4OC	A	1402	1	-	1/9/29/30	0/2/2/2

Continued on next page...

Continued from previous page...

Mol	Type	Chain	Res	Link	Chirals	Torsions	Rings
1	MA6	A	1519	1	-	4/7/29/30	0/3/3/3
22	PSU	a	2604	22	-	0/7/25/26	0/2/2/2
1	5MC	A	1407	1	-	0/7/25/26	0/2/2/2
22	2MG	a	1835	22	-	1/5/27/28	0/3/3/3
22	OMG	a	2251	54,22,56	-	1/5/27/28	0/3/3/3
53	G7M	5	46	53	-	3/3/25/26	0/3/3/3
22	5MU	a	747	22	-	0/7/25/26	0/2/2/2
22	PSU	a	2504	22	-	0/7/25/26	0/2/2/2
1	G7M	A	527	1	-	1/3/25/26	0/3/3/3
54	H2U	6	21	54	-	5/7/38/39	0/2/2/2

All (121) bond length outliers are listed below:

Mol	Chain	Res	Type	Atoms	Z	Observed(Å)	Ideal(Å)
22	a	1915	3TD	C6-C5	12.41	1.49	1.35
22	a	1915	3TD	C2-N1	8.90	1.48	1.37
54	6	8	4SU	C2-N3	7.25	1.50	1.38
22	a	1618	6MZ	C6-N6	7.12	1.46	1.35
22	a	2030	6MZ	C6-N6	7.01	1.46	1.35
54	6	8	4SU	C4-N3	7.00	1.45	1.37
54	6	8	4SU	C2-N1	6.94	1.49	1.38
53	5	8	4SU	C2-N3	6.90	1.50	1.38
53	5	8	4SU	C2-N1	6.89	1.49	1.38
1	A	1498	UR3	C2-N1	6.78	1.48	1.38
22	a	2503	2MA	C2-N3	6.76	1.45	1.31
1	A	1402	4OC	C4-N3	6.47	1.44	1.32
22	a	2552	OMU	C2-N1	6.33	1.48	1.38
1	A	527	G7M	C2-N2	6.33	1.49	1.34
53	5	46	G7M	C2-N2	6.32	1.49	1.34
1	A	1402	4OC	C6-C5	6.19	1.49	1.35
22	a	2069	G7M	C2-N2	6.16	1.48	1.34
53	5	8	4SU	C5-C4	6.11	1.50	1.42
53	5	8	4SU	C4-N3	6.08	1.44	1.37
22	a	2552	OMU	C2-N3	6.00	1.48	1.38
22	a	1915	3TD	C6-N1	5.94	1.46	1.36
53	5	8	4SU	C6-C5	5.86	1.48	1.35
1	A	1498	UR3	C6-C5	5.81	1.48	1.35
22	a	745	1MG	C2-N2	5.78	1.44	1.34
1	A	1402	4OC	C2-N3	5.58	1.47	1.36
22	a	745	1MG	C2-N3	5.54	1.44	1.34
54	6	8	4SU	C5-C4	5.53	1.49	1.42
22	a	2552	OMU	C6-C5	5.52	1.47	1.35

Continued on next page...

Continued from previous page...

Mol	Chain	Res	Type	Atoms	Z	Observed(Å)	Ideal(Å)
1	A	527	G7M	C2-N3	5.48	1.46	1.33
54	6	8	4SU	C6-C5	5.43	1.47	1.35
53	5	46	G7M	C2-N3	5.42	1.46	1.33
22	a	2069	G7M	C2-N3	5.18	1.45	1.33
22	a	1915	3TD	C2'-C1'	-4.93	1.47	1.53
33	l	81	4D4	CZ-NE	4.91	1.43	1.33
1	A	527	G7M	C4-N3	4.90	1.49	1.37
53	5	46	G7M	C6-N1	4.83	1.45	1.37
53	5	46	G7M	C4-N3	4.79	1.49	1.37
1	A	1498	UR3	C2-N3	4.76	1.48	1.39
22	a	2069	G7M	C4-N3	4.60	1.48	1.37
22	a	745	1MG	C4-N3	4.49	1.48	1.37
22	a	2503	2MA	C4-N3	4.42	1.48	1.37
22	a	1915	3TD	C2-N3	4.37	1.48	1.38
53	5	37	MIA	C13-C14	4.36	1.44	1.32
1	A	1402	4OC	C4-N4	4.31	1.44	1.35
54	6	8	4SU	C4-S4	-4.31	1.60	1.68
53	5	8	4SU	C4-S4	-4.12	1.60	1.68
22	a	2069	G7M	C6-N1	4.04	1.43	1.37
1	A	527	G7M	C6-N1	4.01	1.43	1.37
1	A	1402	4OC	C5-C4	3.92	1.49	1.40
1	A	1402	4OC	C2-N1	3.78	1.48	1.40
22	a	2445	2MG	C8-N7	-3.74	1.28	1.35
22	a	2504	PSU	C6-C5	3.62	1.39	1.35
54	6	56	PSU	C6-C5	3.59	1.39	1.35
22	a	1915	3TD	O4'-C1'	3.59	1.48	1.43
53	5	46	G7M	C5-C6	3.45	1.54	1.45
1	A	966	2MG	C8-N7	-3.42	1.29	1.35
22	a	1835	2MG	C8-N7	-3.40	1.29	1.35
22	a	1911	PSU	C6-C5	3.35	1.39	1.35
53	5	37	MIA	C6-N6	3.35	1.40	1.34
22	a	2251	OMG	C8-N7	-3.31	1.29	1.35
22	a	2457	PSU	C6-C5	3.30	1.39	1.35
22	a	2605	PSU	C6-C5	3.29	1.39	1.35
1	A	516	PSU	C6-C5	3.24	1.39	1.35
1	A	527	G7M	C5-C6	3.20	1.53	1.45
22	a	1917	PSU	C6-C5	3.19	1.39	1.35
22	a	2580	PSU	C6-C5	3.18	1.39	1.35
53	5	46	G7M	C2-N1	3.18	1.45	1.37
22	a	2552	OMU	O4-C4	-3.17	1.18	1.24
1	A	1516	2MG	C8-N7	-3.16	1.29	1.35
53	5	32	PSU	C6-C5	3.15	1.39	1.35

Continued on next page...

Continued from previous page...

Mol	Chain	Res	Type	Atoms	Z	Observed(Å)	Ideal(Å)
22	a	2069	G7M	C5-C6	3.14	1.53	1.45
22	a	2552	OMU	O2-C2	-3.13	1.17	1.23
53	5	55	PSU	C6-C5	3.11	1.38	1.35
1	A	1402	4OC	C6-N1	3.10	1.45	1.38
1	A	1402	4OC	O2-C2	-3.09	1.18	1.23
1	A	1207	2MG	C8-N7	-3.07	1.29	1.35
22	a	2604	PSU	C6-C5	3.06	1.38	1.35
22	a	746	PSU	C6-C5	3.05	1.38	1.35
53	5	8	4SU	C6-N1	3.02	1.45	1.38
22	a	745	1MG	C5-C4	-2.98	1.35	1.43
22	a	955	PSU	C6-C5	2.97	1.38	1.35
53	5	39	PSU	C6-C5	2.90	1.38	1.35
22	a	2552	OMU	C4-N3	2.88	1.43	1.38
22	a	2503	2MA	C2-N1	2.84	1.45	1.36
1	A	1498	UR3	C6-N1	2.83	1.44	1.38
1	A	527	G7M	C2-N1	2.81	1.44	1.37
1	A	966	2MG	C5-C6	-2.79	1.41	1.47
22	a	2030	6MZ	C5-C4	-2.75	1.33	1.40
1	A	1518	MA6	C6-N1	2.74	1.37	1.33
53	5	37	MIA	C2-S10	-2.72	1.73	1.75
22	a	1618	6MZ	C5-C4	-2.68	1.33	1.40
22	a	1915	3TD	C4-N3	2.68	1.46	1.40
22	a	2069	G7M	C2-N1	2.67	1.44	1.37
54	6	8	4SU	C6-N1	2.67	1.44	1.38
22	a	2503	2MA	C5-C4	-2.64	1.36	1.43
22	a	2069	G7M	O6-C6	-2.61	1.18	1.23
22	a	2251	OMG	C5-C6	-2.57	1.42	1.47
1	A	1498	UR3	O4-C4	-2.57	1.18	1.23
1	A	1498	UR3	O2-C2	-2.55	1.17	1.22
22	a	745	1MG	O6-C6	-2.47	1.17	1.22
1	A	1516	2MG	C5-C6	-2.45	1.42	1.47
1	A	527	G7M	O6-C6	-2.45	1.18	1.23
1	A	1207	2MG	C5-C6	-2.41	1.42	1.47
53	5	46	G7M	C8-N7	2.40	1.37	1.33
22	a	1835	2MG	C5-C6	-2.38	1.42	1.47
22	a	2445	2MG	C5-C6	-2.33	1.42	1.47
22	a	1915	3TD	O4-C4	-2.27	1.18	1.23
22	a	745	1MG	C6-N1	2.23	1.43	1.39
33	l	81	4D4	CZ-NH1	2.20	1.43	1.34
22	a	2445	2MG	C5-C4	-2.20	1.37	1.43
22	a	2580	PSU	O4'-C1'	-2.19	1.40	1.43
1	A	1516	2MG	C5-C4	-2.17	1.37	1.43

Continued on next page...

Continued from previous page...

Mol	Chain	Res	Type	Atoms	Z	Observed(Å)	Ideal(Å)
1	A	1519	MA6	C6-N1	2.15	1.36	1.33
53	5	46	G7M	O6-C6	-2.15	1.18	1.23
22	a	2251	OMG	C5-C4	-2.09	1.37	1.43
53	5	8	4SU	O2-C2	-2.04	1.19	1.23
22	a	1835	2MG	C5-C4	-2.04	1.37	1.43
22	a	1618	6MZ	C2-N3	2.02	1.35	1.32
12	L	89	D2T	CB1-SB	-2.01	1.75	1.79
1	A	1207	2MG	C5-C4	-2.00	1.38	1.43
1	A	1498	UR3	C4-N3	2.00	1.45	1.40

All (128) bond angle outliers are listed below:

Mol	Chain	Res	Type	Atoms	Z	Observed(°)	Ideal(°)
54	6	8	4SU	C4-N3-C2	-8.13	119.44	127.34
53	5	37	MIA	C12-C13-C14	-7.91	111.74	127.14
53	5	8	4SU	C4-N3-C2	-7.88	119.69	127.34
22	a	2030	6MZ	N3-C2-N1	-6.17	119.04	128.68
22	a	2030	6MZ	C9-N6-C6	-5.74	117.93	122.87
22	a	2552	OMU	C4-N3-C2	-5.69	119.07	126.58
22	a	1618	6MZ	N3-C2-N1	-5.56	119.99	128.68
54	6	8	4SU	C5-C4-N3	5.41	119.70	114.69
1	A	1498	UR3	C4-N3-C2	-5.21	119.66	124.56
22	a	1915	3TD	N1-C2-N3	5.20	120.24	116.14
22	a	2457	PSU	N1-C2-N3	5.19	121.01	115.13
22	a	2030	6MZ	C2-N1-C6	5.06	120.93	116.59
22	a	2457	PSU	C4-N3-C2	-4.92	119.26	126.34
53	5	55	PSU	C4-N3-C2	-4.89	119.30	126.34
53	5	55	PSU	N1-C2-N3	4.84	120.62	115.13
22	a	955	PSU	C4-N3-C2	-4.84	119.36	126.34
22	a	1917	PSU	C4-N3-C2	-4.84	119.37	126.34
22	a	2605	PSU	C4-N3-C2	-4.84	119.37	126.34
22	a	2604	PSU	C4-N3-C2	-4.79	119.43	126.34
53	5	8	4SU	C5-C4-N3	4.78	119.13	114.69
53	5	39	PSU	C4-N3-C2	-4.76	119.48	126.34
22	a	2605	PSU	N1-C2-N3	4.76	120.52	115.13
22	a	1917	PSU	N1-C2-N3	4.71	120.47	115.13
22	a	1911	PSU	N1-C2-N3	4.71	120.46	115.13
22	a	955	PSU	N1-C2-N3	4.69	120.45	115.13
22	a	746	PSU	C4-N3-C2	-4.68	119.60	126.34
53	5	32	PSU	C4-N3-C2	-4.65	119.64	126.34
22	a	2604	PSU	N1-C2-N3	4.63	120.38	115.13
22	a	746	PSU	N1-C2-N3	4.61	120.36	115.13

Continued on next page...

Continued from previous page...

Mol	Chain	Res	Type	Atoms	Z	Observed(°)	Ideal(°)
53	5	8	4SU	N3-C2-N1	4.60	121.00	114.89
22	a	1911	PSU	C4-N3-C2	-4.58	119.75	126.34
22	a	2580	PSU	N1-C2-N3	4.57	120.30	115.13
22	a	2580	PSU	C4-N3-C2	-4.56	119.77	126.34
1	A	516	PSU	C4-N3-C2	-4.54	119.80	126.34
53	5	32	PSU	N1-C2-N3	4.44	120.16	115.13
22	a	2504	PSU	C4-N3-C2	-4.31	120.12	126.34
22	a	2504	PSU	N1-C2-N3	4.31	120.02	115.13
54	6	56	PSU	C4-N3-C2	-4.31	120.13	126.34
53	5	39	PSU	N1-C2-N3	4.29	119.99	115.13
33	l	81	4D4	NE-CZ-NH2	4.28	128.23	120.70
54	6	56	PSU	N1-C2-N3	4.26	119.96	115.13
1	A	516	PSU	N1-C2-N3	4.26	119.95	115.13
22	a	1618	6MZ	C2-N1-C6	4.23	120.21	116.59
22	a	1915	3TD	C4-N3-C2	-4.15	120.11	124.61
22	a	745	1MG	C5-C6-N1	4.09	120.05	113.90
54	6	8	4SU	C5-C4-S4	-3.99	119.32	124.47
53	5	37	MIA	C11-S10-C2	-3.98	99.29	102.27
22	a	1618	6MZ	C9-N6-C6	-3.95	119.47	122.87
22	a	2552	OMU	N3-C2-N1	3.85	120.00	114.89
22	a	2552	OMU	C5-C4-N3	3.82	120.56	114.84
12	L	89	D2T	OD2-CG-CB	3.78	121.33	113.15
54	6	8	4SU	N3-C2-N1	3.78	119.91	114.89
22	a	2503	2MA	C5-C6-N1	3.76	120.51	114.02
1	A	1519	MA6	N3-C2-N1	-3.37	123.41	128.68
53	5	37	MIA	C16-C14-C13	-3.22	113.34	122.65
1	A	1519	MA6	C4-C5-N7	-3.16	106.11	109.40
1	A	1518	MA6	N3-C2-N1	-3.16	123.75	128.68
53	5	37	MIA	C2-N3-C4	3.13	119.64	115.32
22	a	1915	3TD	C2'-C3'-C4'	3.12	108.70	102.64
22	a	955	PSU	O2-C2-N1	-3.07	119.41	122.79
33	l	81	4D4	CB-CA-C	-2.98	107.02	111.77
54	6	21	H2U	C5-C4-N3	-2.97	113.32	116.65
22	a	1915	3TD	O4'-C1'-C2'	2.91	109.24	105.14
22	a	2069	G7M	C2-N1-C6	-2.90	119.76	125.10
33	l	81	4D4	O-C-CA	-2.90	117.19	124.78
1	A	527	G7M	C2-N1-C6	-2.89	119.78	125.10
22	a	2449	H2U	C5-C4-N3	-2.88	113.42	116.65
53	5	46	G7M	C2-N1-C6	-2.87	119.81	125.10
22	a	745	1MG	C8-N7-C5	2.84	108.41	102.99
53	5	37	MIA	C15-C14-C13	-2.83	114.45	122.65
53	5	55	PSU	O2-C2-N1	-2.82	119.68	122.79

Continued on next page...

Continued from previous page...

Mol	Chain	Res	Type	Atoms	Z	Observed(°)	Ideal(°)
22	a	2552	OMU	O4-C4-C5	-2.80	120.24	125.16
22	a	2504	PSU	C6-N1-C2	-2.78	119.84	122.68
22	a	1915	3TD	C3'-C2'-C1'	-2.72	98.46	101.64
22	a	2503	2MA	C8-N7-C5	2.70	108.12	102.99
33	l	81	4D4	NH1-CZ-NE	-2.69	113.00	119.19
1	A	1519	MA6	C9-N6-C6	-2.67	111.42	119.51
22	a	746	PSU	O2-C2-N1	-2.67	119.85	122.79
1	A	1518	MA6	C4-C5-N7	-2.66	106.63	109.40
22	a	2580	PSU	O4'-C1'-C2'	2.58	108.78	105.14
53	5	39	PSU	O2-C2-N1	-2.57	119.96	122.79
53	5	32	PSU	O2-C2-N1	-2.52	120.01	122.79
22	a	1917	PSU	O2-C2-N1	-2.51	120.03	122.79
22	a	2504	PSU	O2-C2-N1	-2.50	120.03	122.79
53	5	8	4SU	O2-C2-N1	-2.50	119.47	122.79
53	5	37	MIA	C4-C5-N7	-2.47	106.82	109.40
53	5	46	G7M	N2-C2-N1	2.43	121.88	116.71
22	a	1915	3TD	O4'-C4'-C3'	-2.40	100.36	105.11
22	a	1911	PSU	O2-C2-N1	-2.39	120.16	122.79
1	A	1518	MA6	C9-N6-C6	-2.39	112.27	119.51
22	a	2552	OMU	O2-C2-N1	-2.38	119.62	122.79
22	a	745	1MG	CM1-N1-C6	2.35	120.77	117.55
53	5	55	PSU	C6-C5-C4	2.35	119.84	118.20
54	6	8	4SU	O2-C2-N1	-2.34	119.68	122.79
22	a	2457	PSU	O2-C2-N1	-2.33	120.22	122.79
54	6	33	OMC	C1'-N1-C2	2.33	123.63	118.42
22	a	2457	PSU	C6-N1-C2	-2.32	120.32	122.68
22	a	1835	2MG	O6-C6-C5	2.30	128.87	124.37
22	a	2604	PSU	O2-C2-N1	-2.30	120.26	122.79
1	A	516	PSU	O2-C2-N1	-2.30	120.26	122.79
22	a	745	1MG	O6-C6-C5	-2.29	120.14	124.19
12	L	89	D2T	CB-CA-N	2.28	113.96	109.10
53	5	32	PSU	C6-C5-C4	2.28	119.79	118.20
22	a	2457	PSU	C6-C5-C4	2.28	119.79	118.20
1	A	1207	2MG	O6-C6-C5	2.27	128.80	124.37
1	A	516	PSU	O4'-C1'-C2'	2.25	108.31	105.14
54	6	56	PSU	O2-C2-N1	-2.22	120.34	122.79
53	5	8	4SU	C5-C4-S4	-2.22	121.61	124.47
22	a	1911	PSU	C6-N1-C2	-2.19	120.45	122.68
53	5	37	MIA	C12-N6-C6	-2.18	119.31	122.55
1	A	1402	4OC	C6-C5-C4	2.17	119.61	116.96
1	A	1498	UR3	C1'-N1-C2	2.15	120.61	116.99
22	a	2605	PSU	C6-C5-C4	2.13	119.69	118.20

Continued on next page...

Continued from previous page...

Mol	Chain	Res	Type	Atoms	Z	Observed(°)	Ideal(°)
22	a	2445	2MG	O6-C6-C5	2.12	128.52	124.37
54	6	56	PSU	C6-N1-C2	-2.12	120.51	122.68
53	5	55	PSU	C6-N1-C2	-2.10	120.54	122.68
22	a	2251	OMG	O6-C6-C5	2.10	128.47	124.37
1	A	1516	2MG	O6-C6-C5	2.07	128.41	124.37
22	a	1911	PSU	C6-C5-C4	2.06	119.64	118.20
22	a	2580	PSU	O2-C2-N1	-2.06	120.52	122.79
1	A	1519	MA6	C10-N6-C6	-2.06	113.28	119.51
22	a	2605	PSU	O2-C2-N1	-2.06	120.53	122.79
22	a	2580	PSU	C6-C5-C4	2.04	119.62	118.20
22	a	2580	PSU	C6-N1-C2	-2.03	120.60	122.68
22	a	2457	PSU	O4'-C1'-C2'	2.02	107.99	105.14
12	L	89	D2T	OD1-CG-CB	-2.02	118.22	122.44
22	a	955	PSU	C6-C5-C4	2.02	119.61	118.20
53	5	32	PSU	C6-N1-C2	-2.01	120.63	122.68

There are no chirality outliers.

All (47) torsion outliers are listed below:

Mol	Chain	Res	Type	Atoms
1	A	1518	MA6	C5-C6-N6-C9
1	A	1519	MA6	C5-C6-N6-C10
25	d	150	MEQ	C-CA-CB-CG
53	5	37	MIA	C12-C13-C14-C15
53	5	37	MIA	C12-C13-C14-C16
54	6	21	H2U	O4'-C1'-N1-C6
54	6	21	H2U	C2'-C1'-N1-C2
54	6	21	H2U	C2'-C1'-N1-C6
54	6	56	PSU	O4'-C1'-C5-C4
54	6	56	PSU	O4'-C1'-C5-C6
11	K	119	IAS	N-CA-CB-CG
11	K	119	IAS	C-CA-CB-CG
11	K	119	IAS	CA-CB-CG-OD1
22	a	2030	6MZ	O4'-C4'-C5'-O5'
22	a	2251	OMG	C1'-C2'-O2'-CM2
22	a	2445	2MG	C3'-C4'-C5'-O5'
1	A	1519	MA6	O4'-C4'-C5'-O5'
1	A	1519	MA6	C3'-C4'-C5'-O5'
22	a	2030	6MZ	C3'-C4'-C5'-O5'
1	A	1519	MA6	N1-C6-N6-C10
25	d	150	MEQ	NE2-CD-CG-CB
25	d	150	MEQ	OE1-CD-CG-CB

Continued on next page...

Continued from previous page...

Mol	Chain	Res	Type	Atoms
1	A	966	2MG	C3'-C4'-C5'-O5'
22	a	2445	2MG	O4'-C4'-C5'-O5'
53	5	37	MIA	C5-C6-N6-C12
1	A	966	2MG	O4'-C4'-C5'-O5'
53	5	37	MIA	N1-C6-N6-C12
12	L	89	D2T	SB-CB-CG-OD1
25	d	150	MEQ	N-CA-CB-CG
53	5	46	G7M	C3'-C4'-C5'-O5'
1	A	527	G7M	C4'-C5'-O5'-P
54	6	21	H2U	C4'-C5'-O5'-P
22	a	2503	2MA	C4'-C5'-O5'-P
53	5	37	MIA	N3-C2-S10-C11
53	5	46	G7M	C4'-C5'-O5'-P
22	a	2069	G7M	C4'-C5'-O5'-P
22	a	2069	G7M	O4'-C4'-C5'-O5'
54	6	21	H2U	O4'-C1'-N1-C2
53	5	37	MIA	N1-C2-S10-C11
12	L	89	D2T	CG-CB-SB-CB1
22	a	746	PSU	O4'-C1'-C5-C6
1	A	1402	4OC	O4'-C4'-C5'-O5'
53	5	46	G7M	O4'-C4'-C5'-O5'
22	a	1835	2MG	O4'-C4'-C5'-O5'
22	a	2503	2MA	O4'-C4'-C5'-O5'
54	6	33	OMC	C2'-C1'-N1-C2
22	a	2449	H2U	C4'-C5'-O5'-P

There are no ring outliers.

No monomer is involved in short contacts.

5.5 Carbohydrates [i](#)

There are no monosaccharides in this entry.

5.6 Ligand geometry [i](#)

Of 436 ligands modelled in this entry, 408 are monoatomic - leaving 28 for Mogul analysis.

In the following table, the Counts columns list the number of bonds (or angles) for which Mogul statistics could be retrieved, the number of bonds (or angles) that are observed in the model and the number of bonds (or angles) that are defined in the Chemical Component Dictionary. The Link column lists molecule types, if any, to which the group is linked. The Z score for a bond

length (or angle) is the number of standard deviations the observed value is removed from the expected value. A bond length (or angle) with $|Z| > 2$ is considered an outlier worth inspection. RMSZ is the root-mean-square of all Z scores of the bond lengths (or angles).

Mol	Type	Chain	Res	Link	Bond lengths			Bond angles		
					Counts	RMSZ	# Z > 2	Counts	RMSZ	# Z > 2
58	84D	a	3255	-	32,33,33	1.49	7 (21%)	40,48,48	1.10	2 (5%)
58	84D	A	1742	-	32,33,33	1.58	6 (18%)	40,48,48	1.31	6 (15%)
58	84D	a	3260	-	32,33,33	1.56	6 (18%)	40,48,48	1.23	5 (12%)
57	SPD	A	1683	-	9,9,9	0.33	0	8,8,8	0.87	0
58	84D	a	3261	-	32,33,33	1.61	7 (21%)	40,48,48	1.13	5 (12%)
58	84D	a	3258	-	32,33,33	1.48	5 (15%)	40,48,48	1.00	2 (5%)
57	SPD	a	3179	-	9,9,9	0.32	0	8,8,8	0.94	0
57	SPD	A	1682	-	9,9,9	0.33	0	8,8,8	0.66	0
57	SPD	a	3171	-	9,9,9	0.36	0	8,8,8	0.79	0
57	SPD	a	3177	-	9,9,9	0.31	0	8,8,8	0.89	0
57	SPD	a	3174	-	9,9,9	0.36	0	8,8,8	0.73	0
57	SPD	a	3168	-	9,9,9	0.29	0	8,8,8	0.79	0
57	SPD	a	3173	-	9,9,9	0.30	0	8,8,8	0.80	0
57	SPD	a	3170	-	9,9,9	0.35	0	8,8,8	0.87	0
58	84D	A	1740	-	32,33,33	1.56	7 (21%)	40,48,48	1.27	6 (15%)
58	84D	a	3257	-	32,33,33	1.54	6 (18%)	40,48,48	1.45	7 (17%)
57	SPD	a	3172	-	9,9,9	0.31	0	8,8,8	0.73	0
58	84D	A	1739	-	32,33,33	1.58	6 (18%)	40,48,48	1.14	4 (10%)
58	84D	a	3256	-	32,33,33	1.58	7 (21%)	40,48,48	1.08	3 (7%)
57	SPD	a	3175	-	9,9,9	0.32	0	8,8,8	0.69	0
57	SPD	a	3176	-	9,9,9	0.34	0	8,8,8	0.67	0
58	84D	A	1738	-	32,33,33	1.52	7 (21%)	40,48,48	1.22	4 (10%)
57	SPD	a	3178	-	9,9,9	0.33	0	8,8,8	0.60	0
58	84D	a	3259	-	32,33,33	1.50	6 (18%)	40,48,48	1.36	5 (12%)
58	84D	a	3262	-	32,33,33	1.57	7 (21%)	40,48,48	1.17	5 (12%)
59	SPM	a	3180	-	13,13,13	0.38	0	12,12,12	0.62	0
57	SPD	a	3169	-	9,9,9	0.35	0	8,8,8	0.74	0
58	84D	A	1741	-	32,33,33	1.63	4 (12%)	40,48,48	1.18	3 (7%)

In the following table, the Chirals column lists the number of chiral outliers, the number of chiral centers analysed, the number of these observed in the model and the number defined in the Chemical Component Dictionary. Similar counts are reported in the Torsion and Rings columns. '-' means no outliers of that kind were identified.

Mol	Type	Chain	Res	Link	Chirals	Torsions	Rings
58	84D	a	3255	-	-	7/12/65/65	0/3/3/3

Continued on next page...

Continued from previous page...

Mol	Type	Chain	Res	Link	Chirals	Torsions	Rings
58	84D	A	1742	-	-	2/12/65/65	0/3/3/3
58	84D	a	3260	-	-	3/12/65/65	0/3/3/3
57	SPD	A	1683	-	-	5/7/7/7	-
58	84D	a	3261	-	-	4/12/65/65	0/3/3/3
58	84D	a	3258	-	-	4/12/65/65	0/3/3/3
57	SPD	a	3179	-	-	2/7/7/7	-
57	SPD	A	1682	-	-	4/7/7/7	-
57	SPD	a	3171	-	-	2/7/7/7	-
57	SPD	a	3177	-	-	1/7/7/7	-
57	SPD	a	3174	-	-	6/7/7/7	-
57	SPD	a	3168	-	-	3/7/7/7	-
57	SPD	a	3173	-	-	3/7/7/7	-
57	SPD	a	3170	-	-	4/7/7/7	-
58	84D	A	1740	-	-	5/12/65/65	0/3/3/3
58	84D	a	3257	-	-	4/12/65/65	0/3/3/3
57	SPD	a	3172	-	-	3/7/7/7	-
58	84D	A	1739	-	-	2/12/65/65	1/3/3/3
58	84D	a	3256	-	-	5/12/65/65	0/3/3/3
57	SPD	a	3175	-	-	3/7/7/7	-
57	SPD	a	3176	-	-	4/7/7/7	-
58	84D	A	1738	-	-	3/12/65/65	0/3/3/3
57	SPD	a	3178	-	-	3/7/7/7	-
58	84D	a	3259	-	-	5/12/65/65	1/3/3/3
58	84D	a	3262	-	-	2/12/65/65	0/3/3/3
59	SPM	a	3180	-	-	7/11/11/11	-
57	SPD	a	3169	-	-	3/7/7/7	-
58	84D	A	1741	-	-	6/12/65/65	0/3/3/3

All (81) bond length outliers are listed below:

Mol	Chain	Res	Type	Atoms	Z	Observed(Å)	Ideal(Å)
58	A	1742	84D	C15-C14	-4.93	1.47	1.53
58	A	1741	84D	C13-C14	-4.80	1.47	1.53
58	a	3256	84D	C15-C14	-4.74	1.47	1.53
58	A	1741	84D	C15-C14	-4.72	1.47	1.53
58	a	3262	84D	C15-C14	-4.63	1.47	1.53

Continued on next page...

Continued from previous page...

Mol	Chain	Res	Type	Atoms	Z	Observed(Å)	Ideal(Å)
58	A	1739	84D	C15-C14	-4.62	1.47	1.53
58	a	3261	84D	C15-C14	-4.56	1.47	1.53
58	a	3260	84D	C15-C14	-4.55	1.47	1.53
58	A	1738	84D	C15-C14	-4.44	1.48	1.53
58	a	3257	84D	C15-C14	-4.42	1.48	1.53
58	A	1740	84D	C15-C14	-4.27	1.48	1.53
58	a	3258	84D	C15-C14	-4.12	1.48	1.53
58	a	3255	84D	C15-C14	-3.99	1.48	1.53
58	a	3256	84D	C13-C14	-3.92	1.48	1.53
58	a	3261	84D	C13-C14	-3.81	1.48	1.53
58	a	3259	84D	C15-C14	-3.79	1.48	1.53
58	a	3259	84D	C13-C14	-3.75	1.48	1.53
58	A	1739	84D	C13-C14	-3.63	1.49	1.53
58	A	1738	84D	C13-C14	-3.63	1.49	1.53
58	a	3258	84D	C13-C14	-3.63	1.49	1.53
58	a	3260	84D	C13-C14	-3.57	1.49	1.53
58	A	1742	84D	C13-C14	-3.57	1.49	1.53
58	a	3262	84D	C13-C14	-3.56	1.49	1.53
58	a	3257	84D	C13-C14	-3.51	1.49	1.53
58	A	1740	84D	C13-C14	-3.46	1.49	1.53
58	a	3255	84D	C13-C14	-3.36	1.49	1.53
58	A	1740	84D	C14-N1	3.30	1.52	1.47
58	a	3259	84D	C14-N1	3.29	1.52	1.47
58	a	3256	84D	C14-N1	3.09	1.52	1.47
58	a	3257	84D	C14-N1	3.04	1.51	1.47
58	a	3255	84D	C14-N1	3.02	1.51	1.47
58	a	3258	84D	C14-N1	3.00	1.51	1.47
58	A	1739	84D	C14-N1	2.95	1.51	1.47
58	A	1738	84D	C14-N1	2.94	1.51	1.47
58	a	3260	84D	C14-N1	2.88	1.51	1.47
58	A	1742	84D	C14-N1	2.87	1.51	1.47
58	a	3261	84D	C14-N1	2.83	1.51	1.47
58	a	3262	84D	C14-N1	2.76	1.51	1.47
58	A	1739	84D	O-C3	2.59	1.48	1.41
58	A	1742	84D	O-C3	2.56	1.48	1.41
58	a	3257	84D	O-C3	2.55	1.48	1.41
58	A	1741	84D	C14-N1	2.47	1.51	1.47
58	A	1741	84D	O-C3	2.47	1.48	1.41
58	a	3262	84D	O-C3	2.44	1.48	1.41
58	a	3259	84D	O4-C16	2.42	1.50	1.44
58	a	3261	84D	O-C3	2.42	1.48	1.41
58	a	3260	84D	O4-C16	2.41	1.50	1.44

Continued on next page...

Continued from previous page...

Mol	Chain	Res	Type	Atoms	Z	Observed(Å)	Ideal(Å)
58	a	3255	84D	O-C3	2.35	1.47	1.41
58	a	3260	84D	O-C3	2.33	1.47	1.41
58	a	3261	84D	O4-C16	2.30	1.49	1.44
58	A	1740	84D	C1-C2	-2.24	1.46	1.52
58	a	3257	84D	C-C1	-2.24	1.47	1.52
58	A	1739	84D	C-C1	-2.24	1.47	1.52
58	a	3258	84D	O-C3	2.23	1.47	1.41
58	a	3261	84D	C-C1	-2.22	1.47	1.52
58	a	3255	84D	C-C1	-2.22	1.47	1.52
58	A	1740	84D	O-C3	2.21	1.47	1.41
58	a	3261	84D	C1-C2	-2.21	1.46	1.52
58	A	1739	84D	O4-C16	2.21	1.49	1.44
58	a	3262	84D	C-C1	-2.20	1.47	1.52
58	a	3262	84D	C1-C2	-2.20	1.46	1.52
58	a	3262	84D	O4-C16	2.19	1.49	1.44
58	A	1738	84D	C-C1	-2.16	1.47	1.52
58	a	3255	84D	C1-C2	-2.15	1.46	1.52
58	A	1742	84D	C-C1	-2.14	1.47	1.52
58	a	3256	84D	O4-C16	2.12	1.49	1.44
58	a	3260	84D	C-C1	-2.10	1.47	1.52
58	a	3255	84D	O4-C16	2.10	1.49	1.44
58	a	3256	84D	O-C3	2.10	1.47	1.41
58	a	3258	84D	C-C1	-2.09	1.47	1.52
58	A	1738	84D	O4-C16	2.08	1.49	1.44
58	a	3256	84D	C-C1	-2.07	1.47	1.52
58	A	1740	84D	O4-C16	2.07	1.49	1.44
58	A	1738	84D	C1-C2	-2.06	1.47	1.52
58	a	3259	84D	O-C3	2.05	1.47	1.41
58	A	1740	84D	C-C1	-2.04	1.47	1.52
58	A	1738	84D	O-C3	2.03	1.47	1.41
58	a	3256	84D	C1-C2	-2.03	1.47	1.52
58	a	3259	84D	C-C1	-2.02	1.47	1.52
58	a	3257	84D	O4-C12	2.01	1.47	1.41
58	A	1742	84D	C1-C2	-2.01	1.47	1.52

All (57) bond angle outliers are listed below:

Mol	Chain	Res	Type	Atoms	Z	Observed(°)	Ideal(°)
58	a	3259	84D	O4-C16-C15	4.36	117.62	109.69
58	A	1738	84D	O-C4-C	4.32	114.50	109.86
58	a	3257	84D	C12-C13-C14	4.04	115.83	110.40
58	a	3262	84D	O-C4-C	3.77	113.91	109.86

Continued on next page...

Continued from previous page...

Mol	Chain	Res	Type	Atoms	Z	Observed(°)	Ideal(°)
58	A	1742	84D	O-C4-C	3.77	113.91	109.86
58	A	1740	84D	O-C4-C	3.69	113.82	109.86
58	a	3260	84D	O-C4-C	3.65	113.78	109.86
58	A	1741	84D	C3-O1-C6	-3.45	109.43	117.96
58	a	3257	84D	C12-O3-C10	-3.41	109.51	117.96
58	a	3261	84D	O-C4-C	3.25	113.35	109.86
58	a	3260	84D	O4-C16-C15	3.08	115.28	109.69
58	A	1740	84D	C3-O-C4	-3.03	109.78	113.13
58	A	1742	84D	C3-O-C4	2.87	116.31	113.13
58	a	3256	84D	C12-O3-C10	-2.70	111.29	117.96
58	a	3260	84D	C3-O1-C6	-2.69	111.30	117.96
58	a	3257	84D	C3-O1-C6	-2.68	111.32	117.96
58	a	3256	84D	C3-O1-C6	-2.63	111.44	117.96
58	A	1739	84D	C10-C11-C6	2.63	114.41	108.96
58	A	1742	84D	C-C4-C5	-2.57	107.92	112.83
58	a	3259	84D	C12-O3-C10	-2.51	111.75	117.96
58	a	3255	84D	C12-O3-C10	-2.50	111.79	117.96
58	A	1742	84D	C3-O1-C6	-2.49	111.80	117.96
58	A	1741	84D	C8-C9-C10	2.49	115.82	109.53
58	a	3261	84D	C12-O3-C10	-2.48	111.83	117.96
58	a	3258	84D	C3-O1-C6	-2.47	111.84	117.96
58	A	1739	84D	C3-O1-C6	-2.47	111.85	117.96
58	a	3262	84D	C-C4-C5	-2.47	108.11	112.83
58	A	1738	84D	C-C4-C5	-2.45	108.16	112.83
58	A	1740	84D	C-C4-C5	-2.43	108.19	112.83
58	a	3260	84D	C17-C16-C15	-2.42	107.34	113.00
58	A	1739	84D	O-C4-C	2.40	112.44	109.86
58	A	1740	84D	C12-O3-C10	-2.39	112.04	117.96
58	a	3260	84D	C-C4-C5	-2.38	108.28	112.83
58	a	3259	84D	O-C4-C	2.35	112.39	109.86
58	a	3259	84D	C3-O1-C6	-2.35	112.15	117.96
58	A	1740	84D	C1-C-C4	2.29	114.34	110.82
58	A	1739	84D	C12-O3-C10	-2.28	112.31	117.96
58	A	1740	84D	C3-O1-C6	-2.26	112.38	117.96
58	a	3257	84D	C-C4-C5	-2.25	108.54	112.83
58	a	3257	84D	O-C4-C	2.24	112.27	109.86
58	a	3257	84D	O4-C12-C13	2.24	115.08	110.35
58	A	1738	84D	C10-C11-C6	2.22	113.56	108.96
58	a	3259	84D	C3-O-C4	-2.20	110.69	113.13
58	A	1742	84D	C12-O3-C10	-2.20	112.52	117.96
58	A	1741	84D	C3-O-C4	-2.19	110.70	113.13
58	a	3261	84D	O4-C16-C15	2.19	113.67	109.69

Continued on next page...

Continued from previous page...

Mol	Chain	Res	Type	Atoms	Z	Observed(°)	Ideal(°)
58	a	3257	84D	C13-C14-N1	-2.18	106.58	111.05
58	a	3258	84D	C12-O3-C10	-2.18	112.58	117.96
58	a	3261	84D	C3-O1-C6	-2.16	112.63	117.96
58	A	1742	84D	C10-C11-C6	2.15	113.42	108.96
58	a	3262	84D	C3-O1-C6	-2.13	112.69	117.96
58	A	1738	84D	C12-O3-C10	-2.09	112.79	117.96
58	a	3255	84D	C-C4-C5	-2.07	108.87	112.83
58	a	3261	84D	C17-C16-C15	-2.06	108.18	113.00
58	a	3262	84D	C12-O3-C10	-2.05	112.89	117.96
58	a	3256	84D	C3-O-C4	-2.05	110.86	113.13
58	a	3262	84D	C17-C16-C15	-2.03	108.25	113.00

There are no chirality outliers.

All (105) torsion outliers are listed below:

Mol	Chain	Res	Type	Atoms
57	a	3174	SPD	C8-C7-N6-C5
58	A	1740	84D	O-C4-C5-N
58	A	1740	84D	C-C4-C5-N
58	a	3255	84D	C-C4-C5-N
58	a	3256	84D	O-C4-C5-N
58	a	3256	84D	C-C4-C5-N
58	a	3257	84D	O-C4-C5-N
58	a	3257	84D	C-C4-C5-N
58	a	3258	84D	O-C4-C5-N
58	a	3259	84D	C-C4-C5-N
58	a	3260	84D	O-C4-C5-N
58	a	3261	84D	O-C4-C5-N
58	a	3261	84D	C-C4-C5-N
58	A	1741	84D	O4-C12-O3-C10
57	a	3176	SPD	N6-C7-C8-C9
58	A	1741	84D	C13-C12-O3-C10
58	A	1738	84D	O4-C16-C17-O5
58	a	3256	84D	O4-C16-C17-O5
59	a	3180	SPM	N10-C11-C12-C13
58	a	3255	84D	C15-C16-C17-O5
57	a	3178	SPD	C3-C4-C5-N6
58	a	3257	84D	O4-C16-C17-O5
58	a	3256	84D	C15-C16-C17-O5
58	a	3259	84D	C15-C16-C17-O5
58	a	3255	84D	O4-C16-C17-O5
58	a	3257	84D	C15-C16-C17-O5

Continued on next page...

Continued from previous page...

Mol	Chain	Res	Type	Atoms
57	a	3170	SPD	C3-C4-C5-N6
57	a	3178	SPD	N6-C7-C8-C9
58	A	1738	84D	C15-C16-C17-O5
57	a	3176	SPD	C3-C4-C5-N6
57	A	1683	SPD	C3-C4-C5-N6
58	A	1739	84D	C15-C16-C17-O5
58	a	3259	84D	O4-C16-C17-O5
57	a	3169	SPD	C3-C4-C5-N6
57	a	3172	SPD	C3-C4-C5-N6
57	a	3173	SPD	C3-C4-C5-N6
58	A	1742	84D	O-C3-O1-C6
57	a	3168	SPD	N6-C7-C8-C9
57	a	3174	SPD	N6-C7-C8-C9
58	A	1739	84D	O4-C16-C17-O5
57	a	3174	SPD	C4-C5-N6-C7
58	A	1741	84D	C11-C10-O3-C12
57	a	3171	SPD	N6-C7-C8-C9
57	a	3168	SPD	C4-C5-N6-C7
57	A	1683	SPD	C2-C3-C4-C5
58	a	3260	84D	C15-C16-C17-O5
57	a	3174	SPD	C3-C4-C5-N6
57	a	3177	SPD	C7-C8-C9-N10
57	a	3178	SPD	C7-C8-C9-N10
57	A	1682	SPD	N6-C7-C8-C9
57	a	3170	SPD	C8-C7-N6-C5
57	a	3169	SPD	C2-C3-C4-C5
58	a	3255	84D	C11-C6-O1-C3
59	a	3180	SPM	C7-C8-C9-N10
57	a	3172	SPD	C2-C3-C4-C5
57	A	1682	SPD	C2-C3-C4-C5
58	A	1740	84D	C15-C16-C17-O5
57	a	3179	SPD	C2-C3-C4-C5
58	a	3258	84D	C15-C16-C17-O5
58	a	3255	84D	O-C3-O1-C6
58	A	1742	84D	C11-C6-O1-C3
58	A	1741	84D	O4-C16-C17-O5
58	a	3261	84D	C11-C6-O1-C3
58	a	3262	84D	C11-C6-O1-C3
58	A	1738	84D	C11-C6-O1-C3
57	a	3168	SPD	C3-C4-C5-N6
57	a	3170	SPD	C2-C3-C4-C5
57	A	1683	SPD	C7-C8-C9-N10

Continued on next page...

Continued from previous page...

Mol	Chain	Res	Type	Atoms
57	a	3170	SPD	C7-C8-C9-N10
59	a	3180	SPM	C8-C9-N10-C11
58	A	1741	84D	C9-C10-O3-C12
58	A	1741	84D	O-C4-C5-N
58	a	3255	84D	O-C4-C5-N
58	a	3259	84D	O-C4-C5-N
58	a	3258	84D	C11-C6-O1-C3
57	a	3173	SPD	C2-C3-C4-C5
58	a	3258	84D	O4-C16-C17-O5
58	a	3259	84D	C11-C6-O1-C3
57	A	1682	SPD	N1-C2-C3-C4
57	a	3174	SPD	N1-C2-C3-C4
57	a	3176	SPD	N1-C2-C3-C4
57	a	3171	SPD	C4-C5-N6-C7
57	a	3175	SPD	C4-C5-N6-C7
57	a	3175	SPD	N6-C7-C8-C9
58	A	1740	84D	C2-C3-O1-C6
57	A	1682	SPD	C7-C8-C9-N10
57	a	3179	SPD	C7-C8-C9-N10
59	a	3180	SPM	N1-C2-C3-C4
57	a	3173	SPD	C8-C7-N6-C5
57	a	3175	SPD	N1-C2-C3-C4
58	a	3256	84D	C11-C6-O1-C3
59	a	3180	SPM	C6-C7-C8-C9
57	a	3169	SPD	C8-C7-N6-C5
58	a	3262	84D	O-C3-O1-C6
59	a	3180	SPM	C3-C4-N5-C6
58	a	3260	84D	O4-C16-C17-O5
57	a	3176	SPD	C4-C5-N6-C7
57	a	3174	SPD	C7-C8-C9-N10
59	a	3180	SPM	C11-C12-C13-N14
57	A	1683	SPD	C8-C7-N6-C5
58	a	3261	84D	O4-C16-C17-O5
58	a	3255	84D	C7-C6-O1-C3
57	A	1683	SPD	C4-C5-N6-C7
57	a	3172	SPD	C8-C7-N6-C5
58	A	1740	84D	O4-C16-C17-O5

All (2) ring outliers are listed below:

Mol	Chain	Res	Type	Atoms
58	a	3259	84D	C-C1-C2-C3-C4-O

Continued on next page...

Continued from previous page...

Mol	Chain	Res	Type	Atoms
58	A	1739	84D	C-C1-C2-C3-C4-O

No monomer is involved in short contacts.

The following is a two-dimensional graphical depiction of Mogul quality analysis of bond lengths, bond angles, torsion angles, and ring geometry for all instances of the Ligand of Interest. In addition, ligands with molecular weight > 250 and outliers as shown on the validation Tables will also be included. For torsion angles, if less than 5% of the Mogul distribution of torsion angles is within 10 degrees of the torsion angle in question, then that torsion angle is considered an outlier. Any bond that is central to one or more torsion angles identified as an outlier by Mogul will be highlighted in the graph. For rings, the root-mean-square deviation (RMSD) between the ring in question and similar rings identified by Mogul is calculated over all ring torsion angles. If the average RMSD is greater than 60 degrees and the minimal RMSD between the ring in question and any Mogul-identified rings is also greater than 60 degrees, then that ring is considered an outlier. The outliers are highlighted in purple. The color gray indicates Mogul did not find sufficient equivalents in the CSD to analyse the geometry.

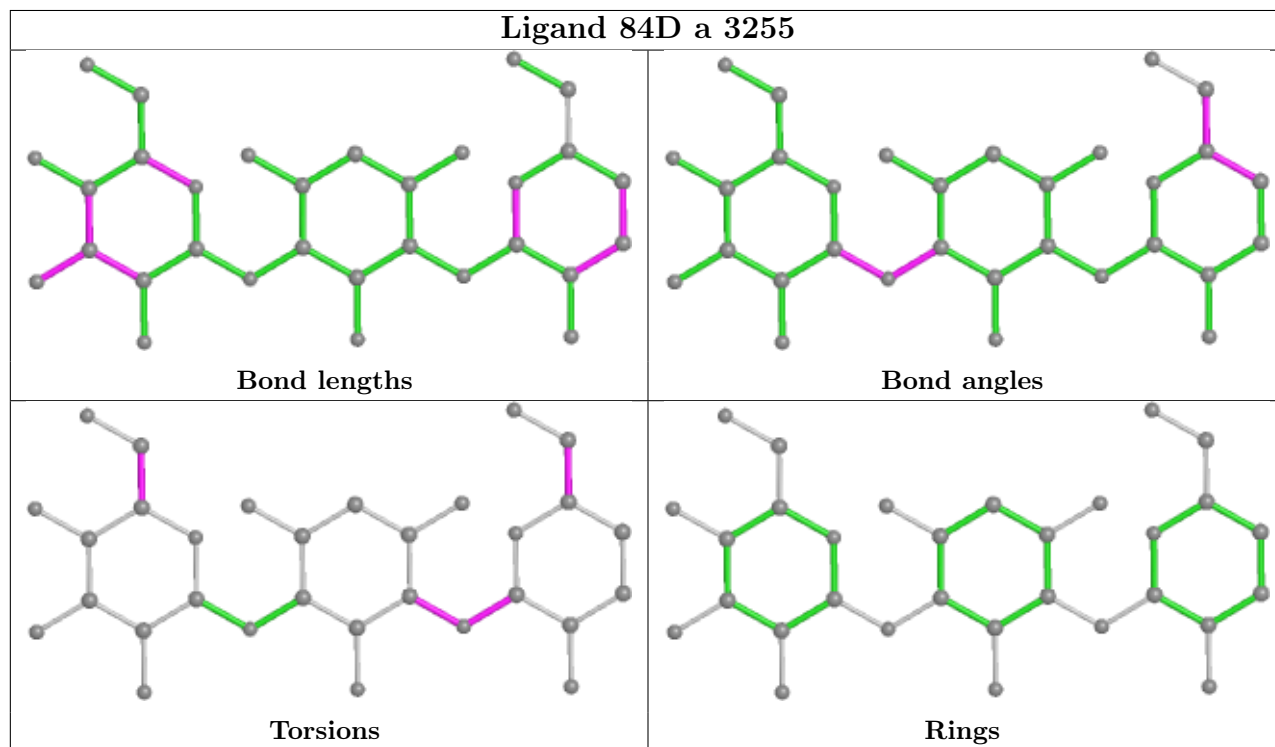

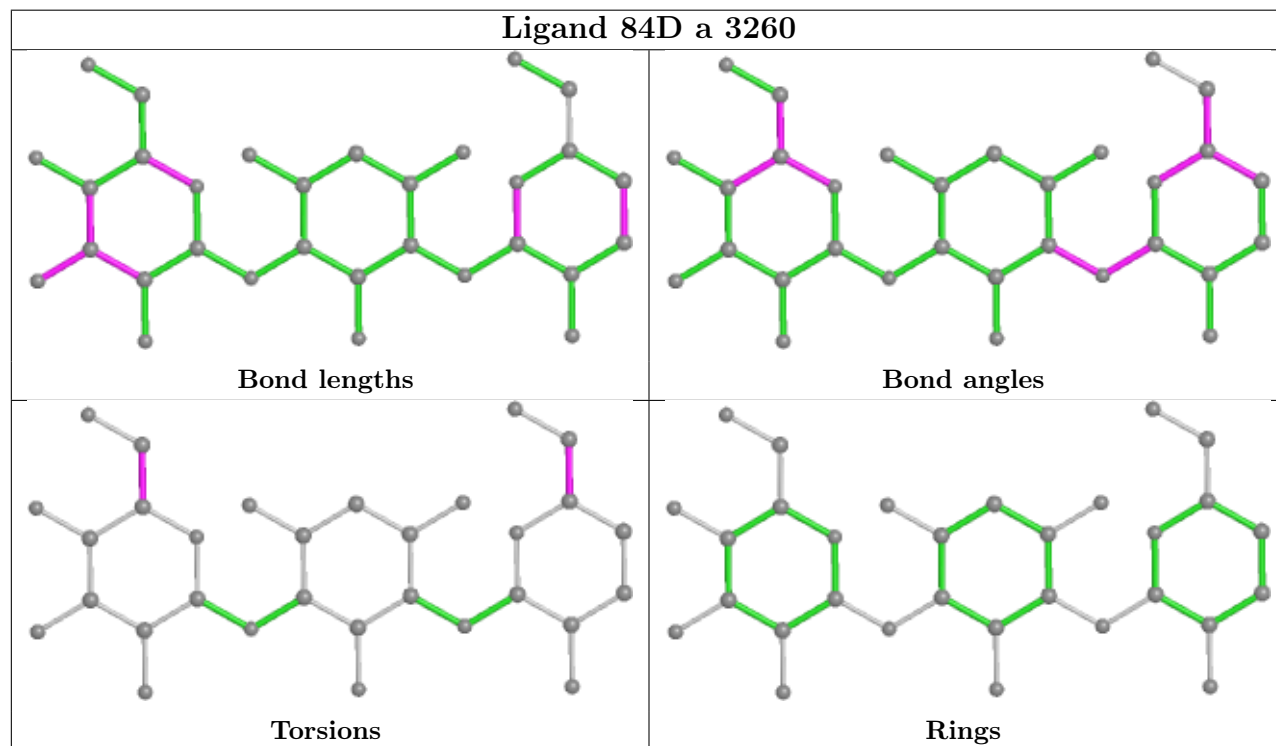
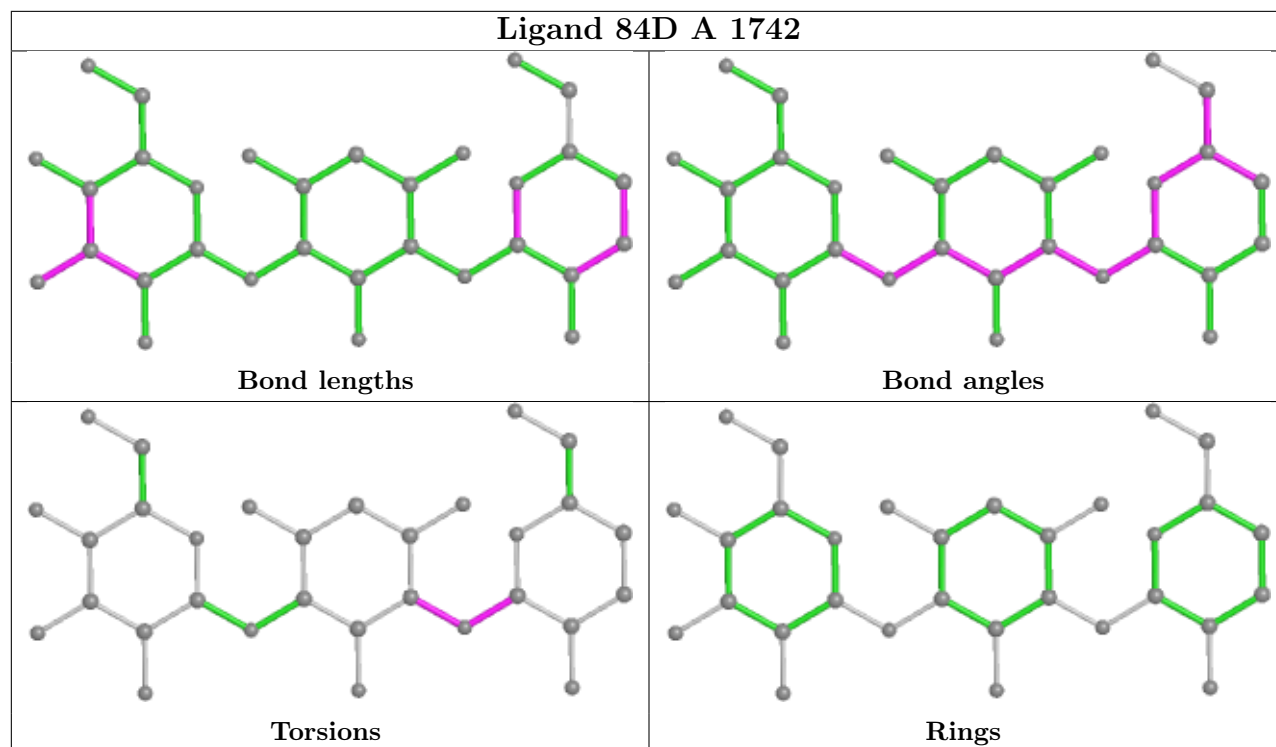

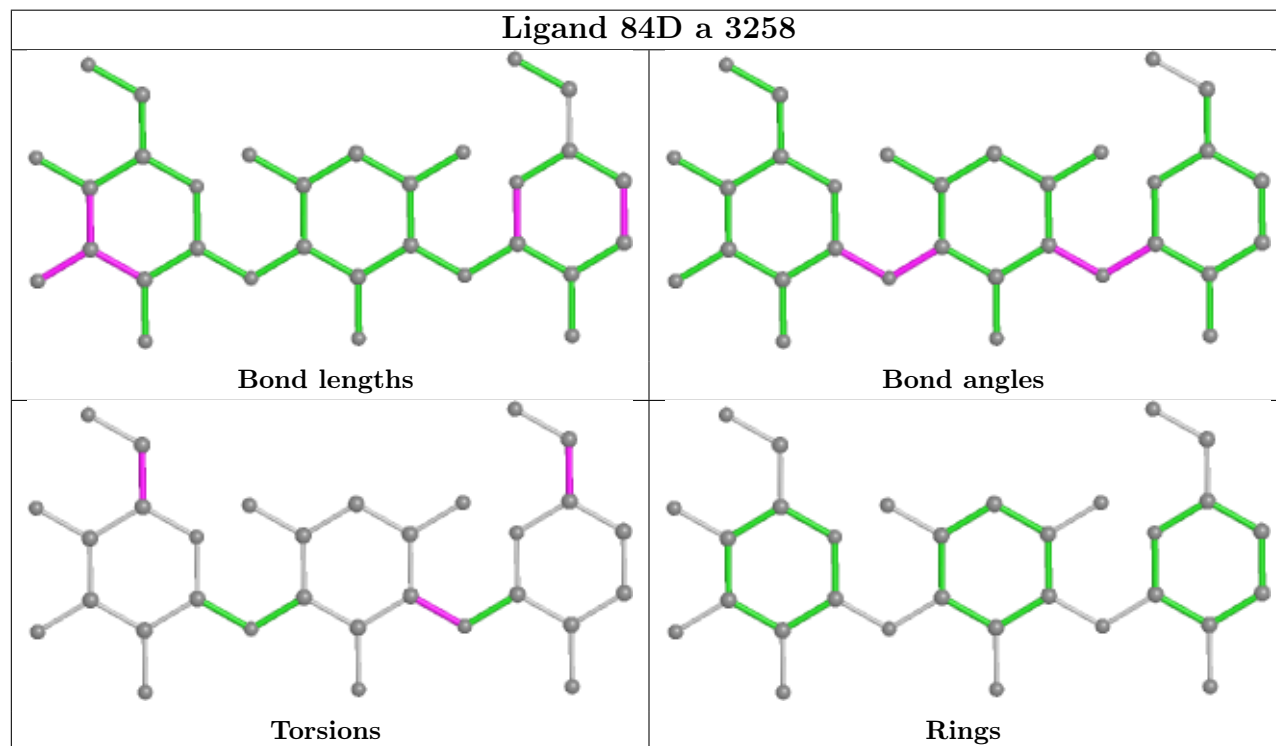
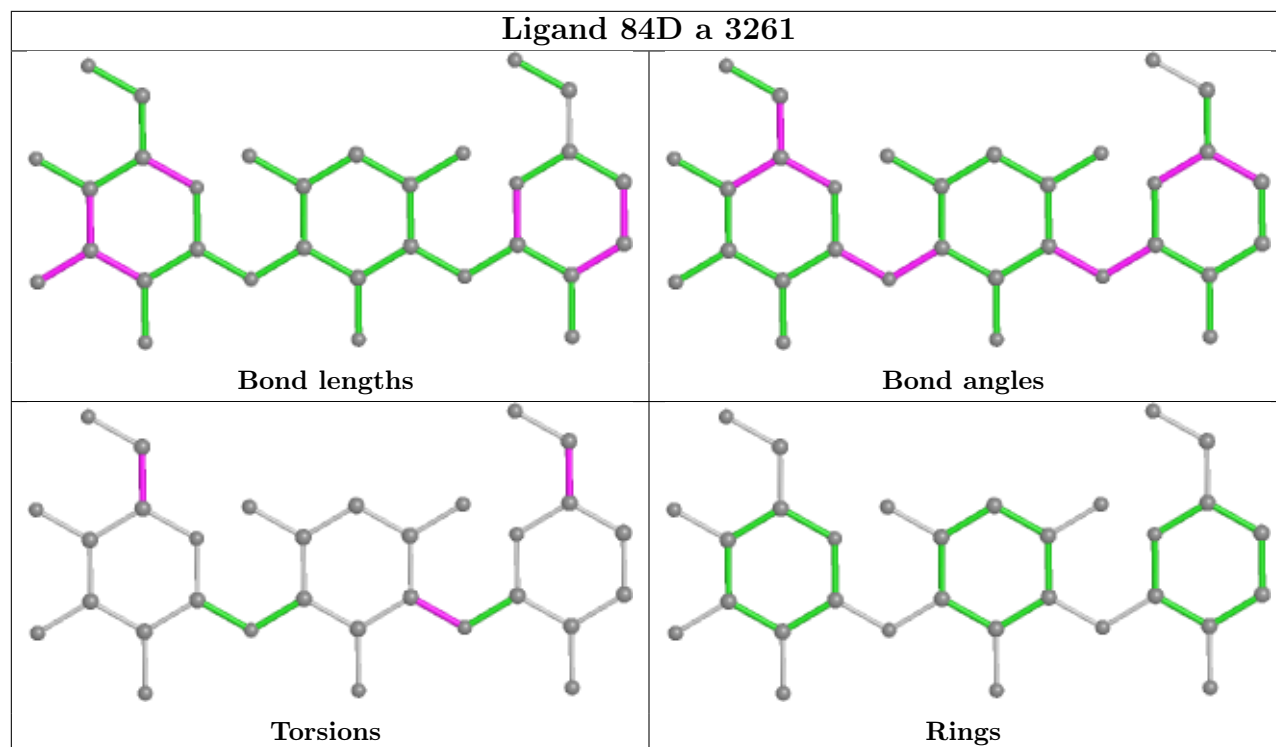

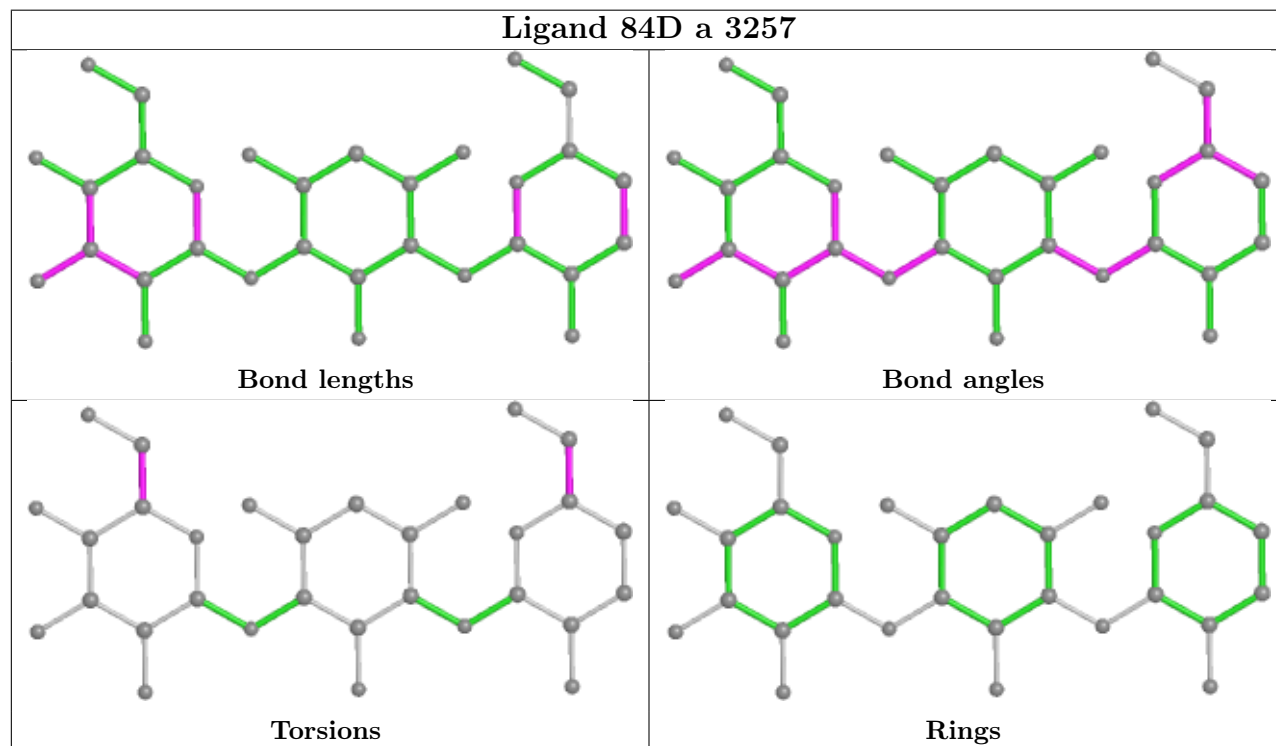
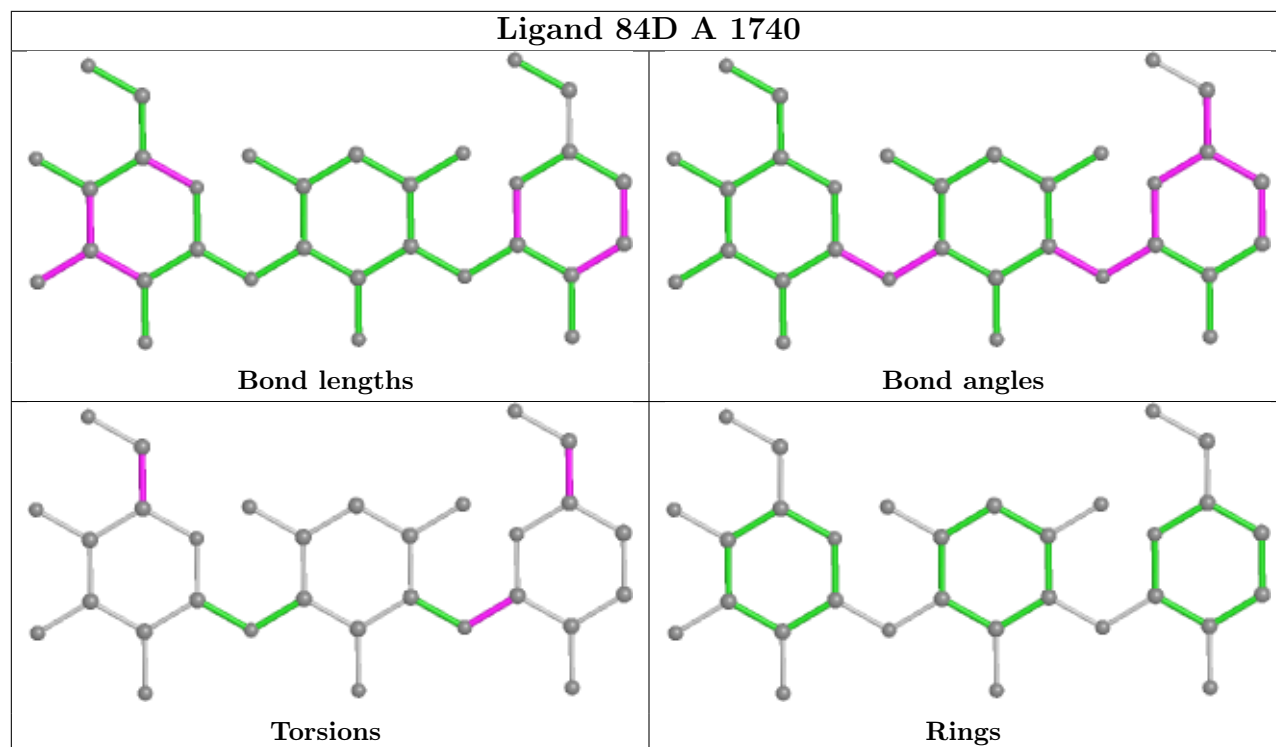

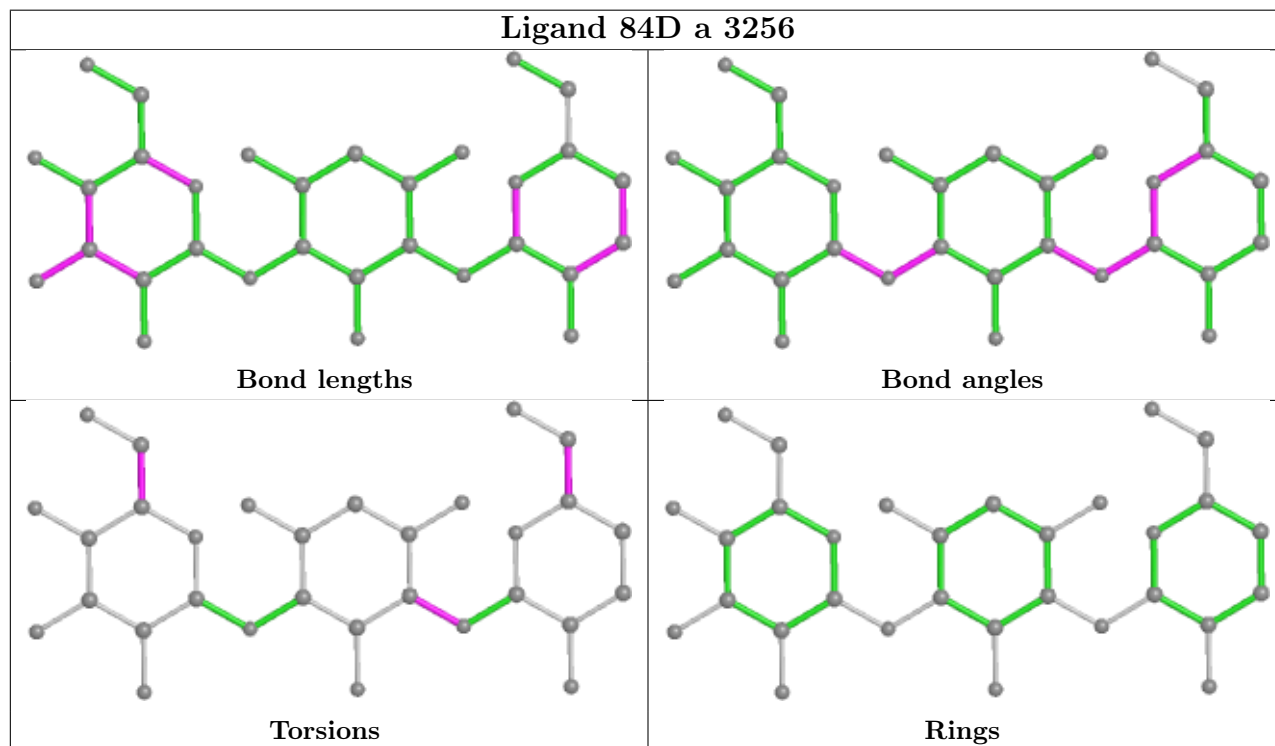
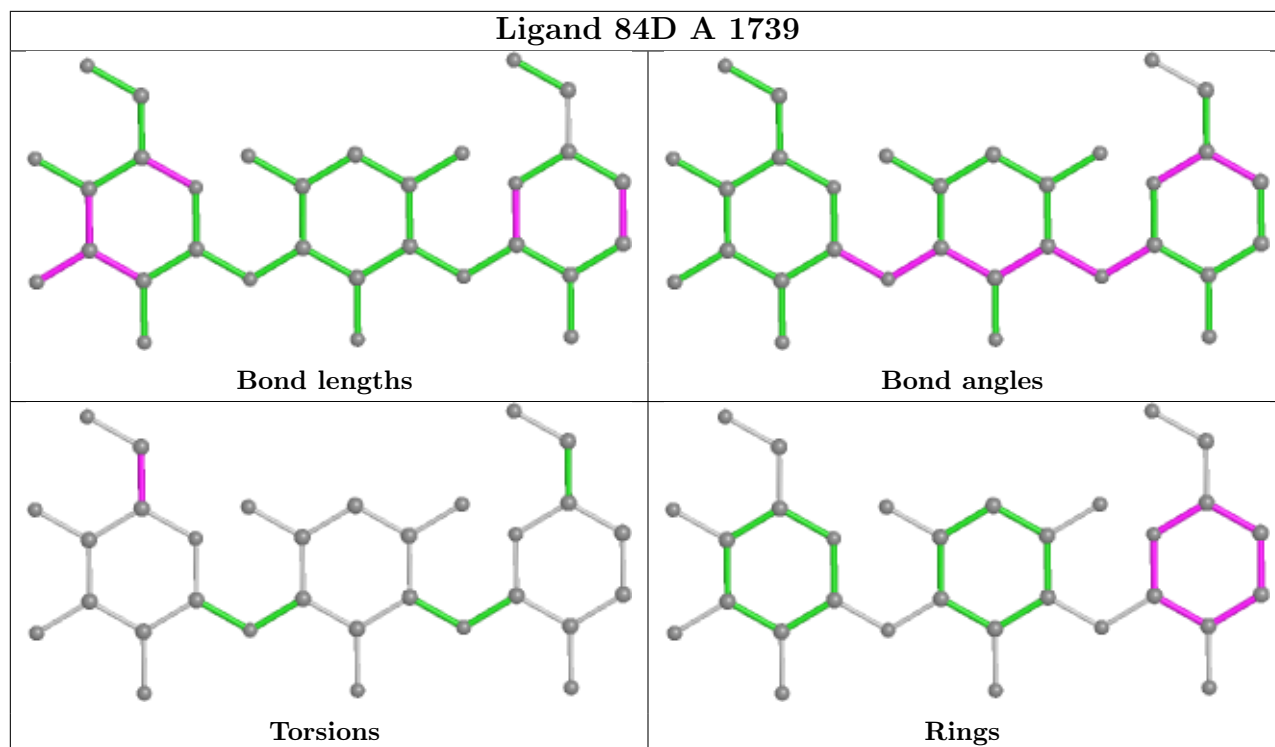

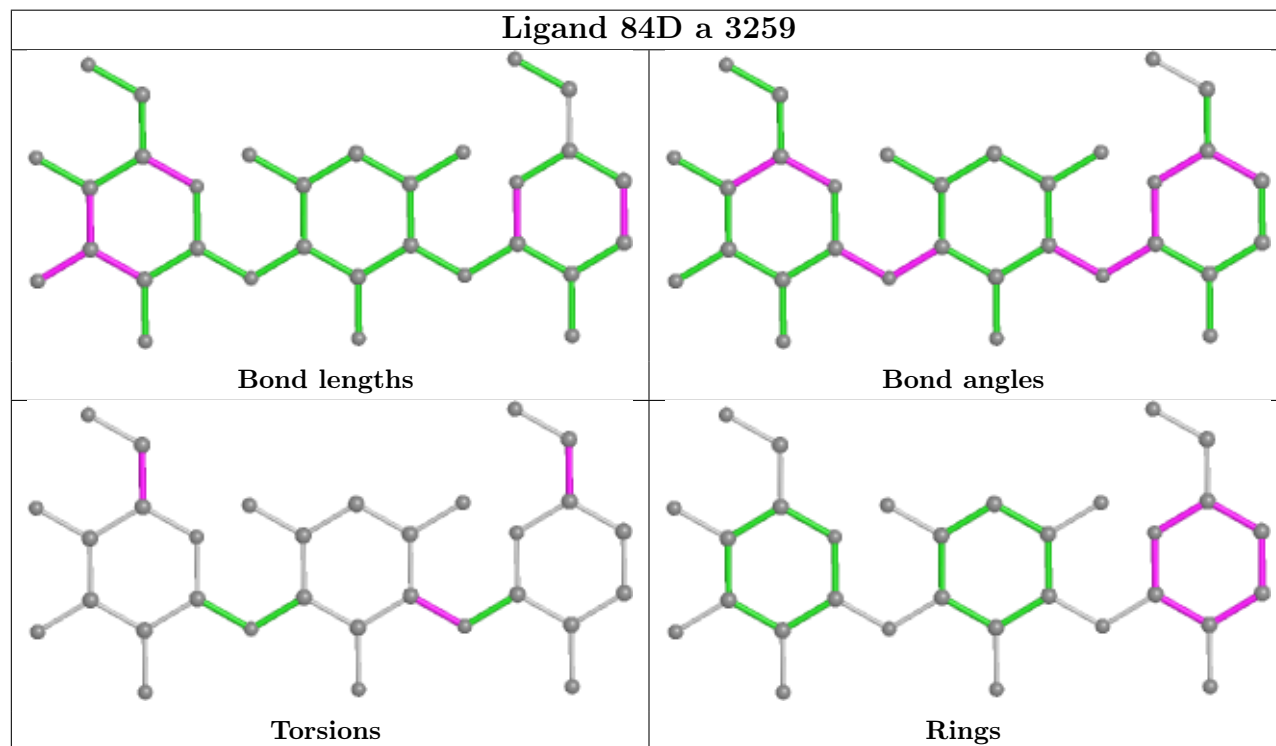
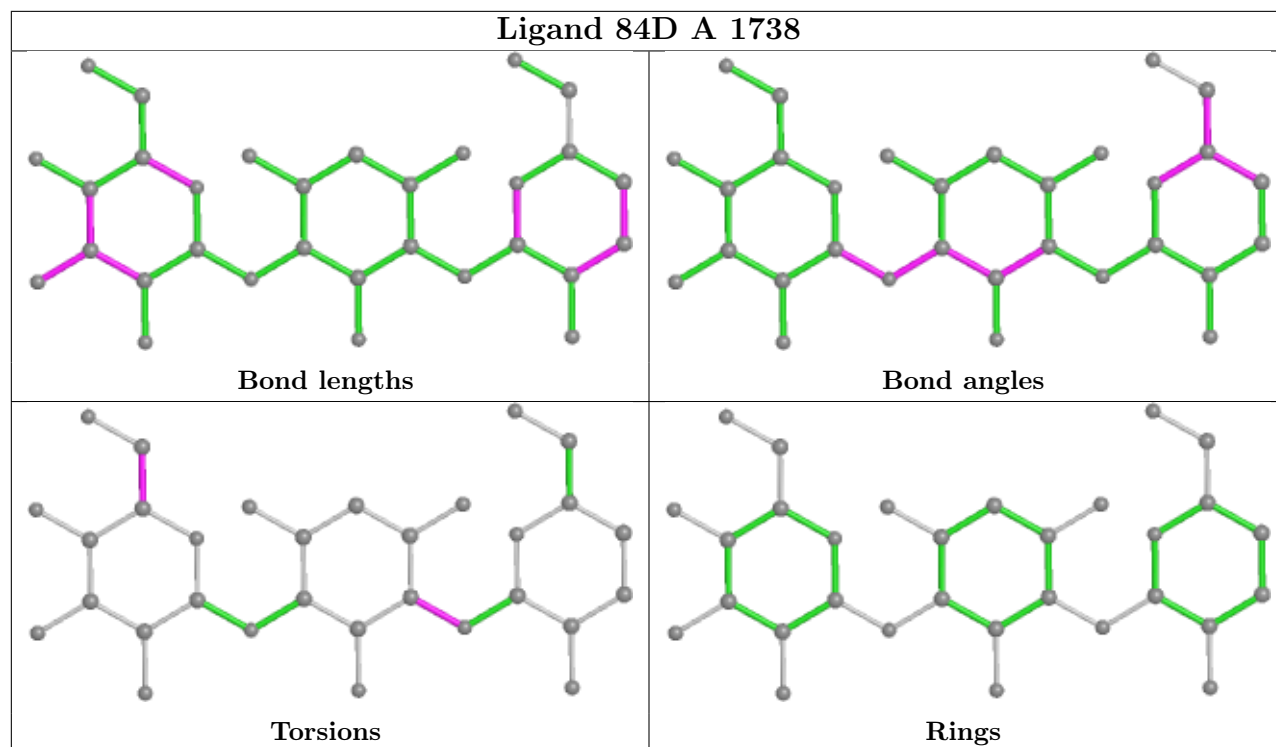

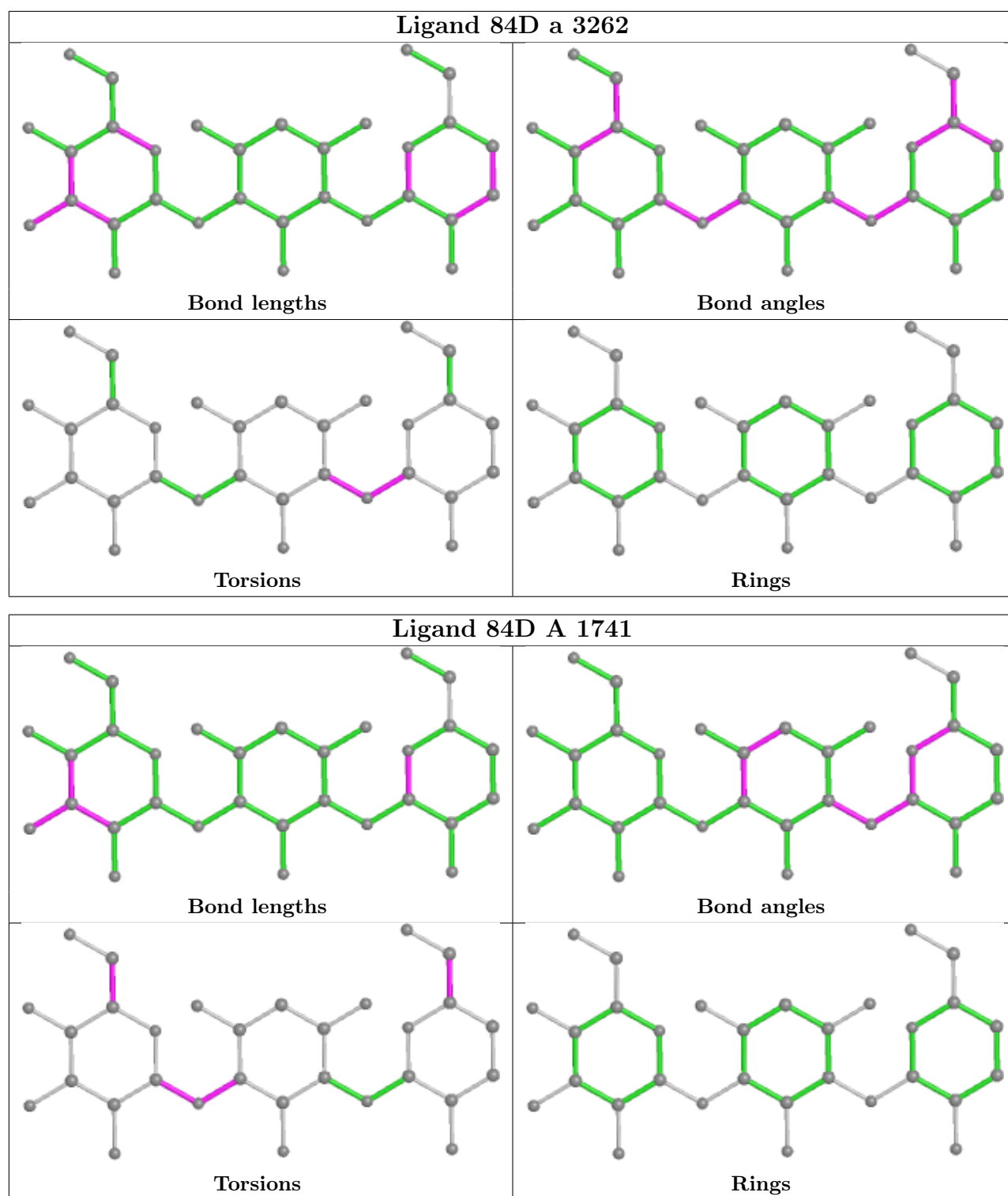

5.7 Other polymers [\(i\)](#)

There are no such residues in this entry.

5.8 Polymer linkage issues

There are no chain breaks in this entry.

6 Map visualisation [i](#)

This section contains visualisations of the EMDB entry EMD-35411. These allow visual inspection of the internal detail of the map and identification of artifacts.

Images derived from a raw map, generated by summing the deposited half-maps, are presented below the corresponding image components of the primary map to allow further visual inspection and comparison with those of the primary map.

6.1 Orthogonal projections [i](#)

6.1.1 Primary map

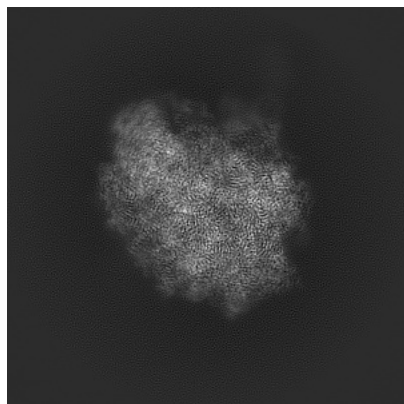

X

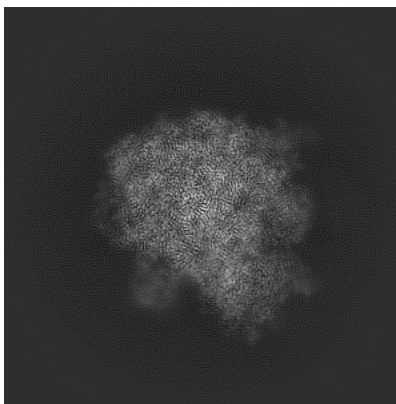

Y

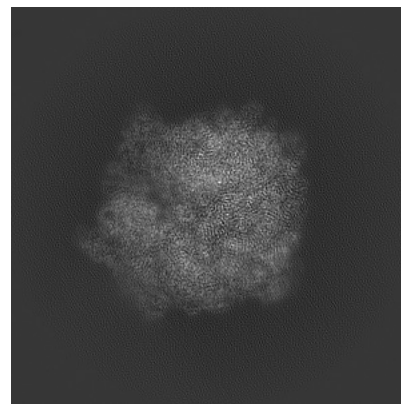

Z

6.1.2 Raw map

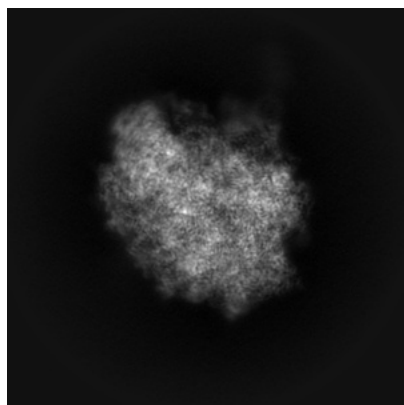

X

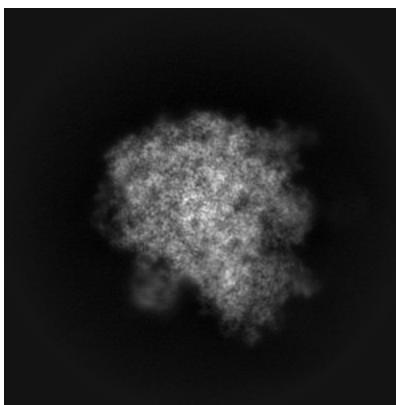

Y

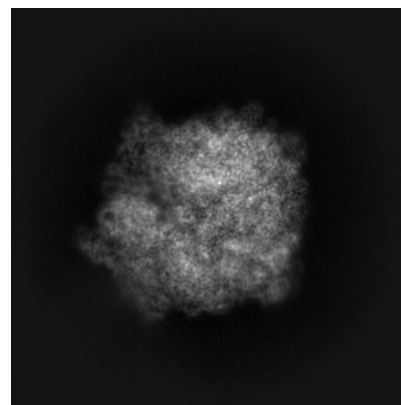

Z

The images above show the map projected in three orthogonal directions.

6.2 Central slices [i](#)

6.2.1 Primary map

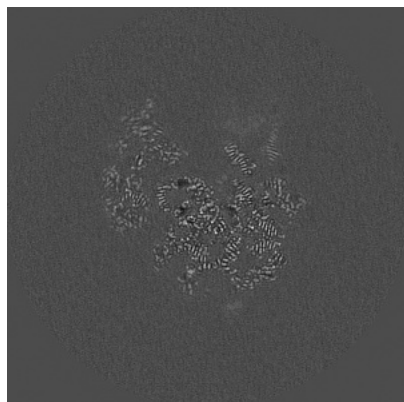

X Index: 256

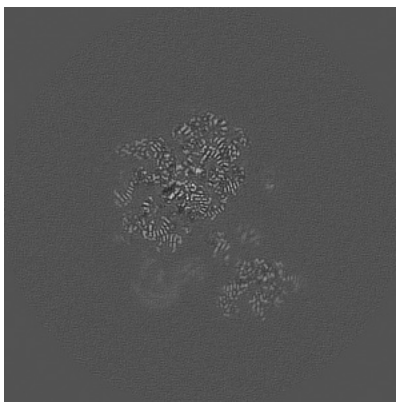

Y Index: 256

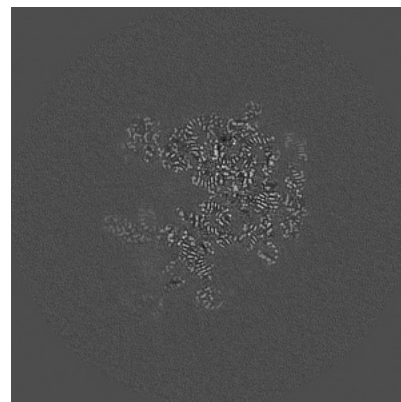

Z Index: 256

6.2.2 Raw map

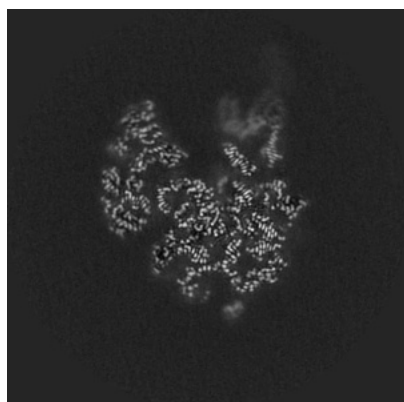

X Index: 256

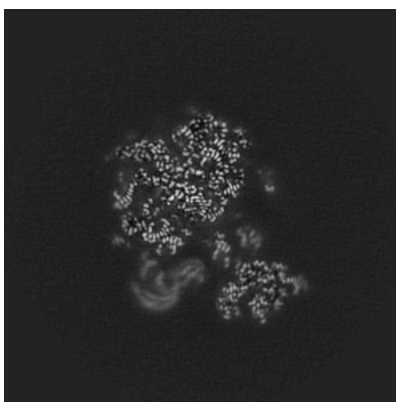

Y Index: 256

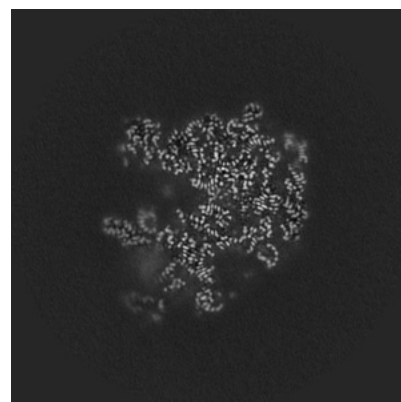

Z Index: 256

The images above show central slices of the map in three orthogonal directions.

6.3 Largest variance slices [i](#)

6.3.1 Primary map

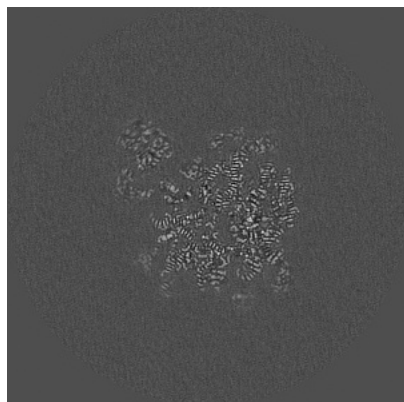

X Index: 289

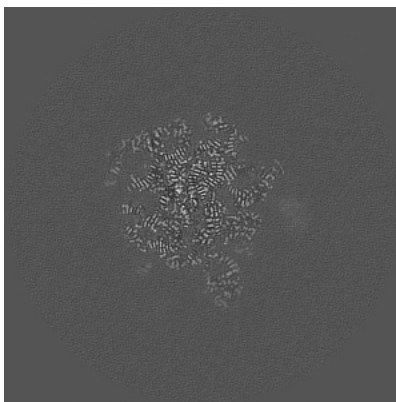

Y Index: 313

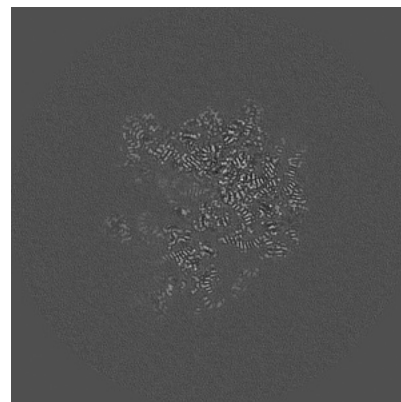

Z Index: 264

6.3.2 Raw map

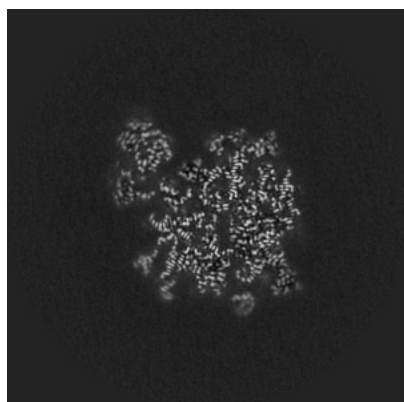

X Index: 288

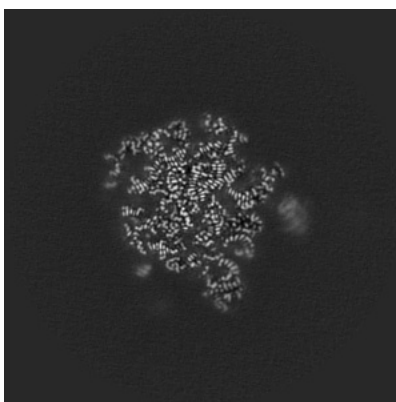

Y Index: 314

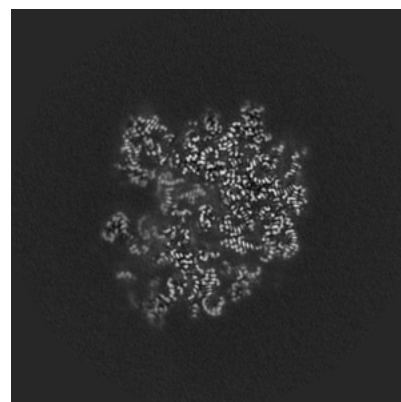

Z Index: 268

The images above show the largest variance slices of the map in three orthogonal directions.

6.4 Orthogonal standard-deviation projections (False-color) [i](#)

6.4.1 Primary map

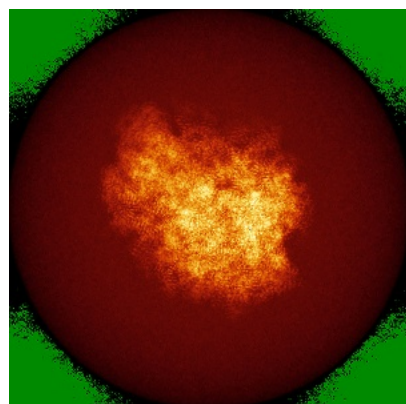

X

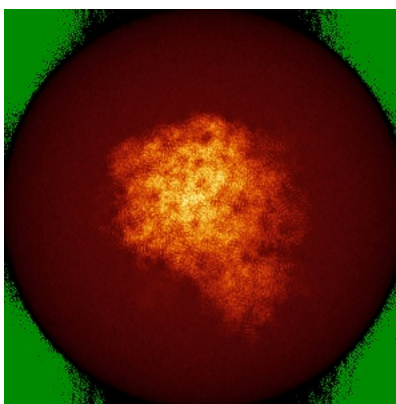

Y

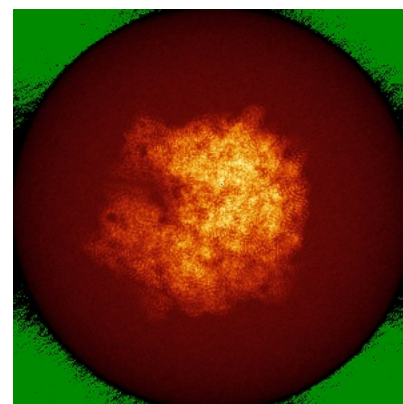

Z

6.4.2 Raw map



X

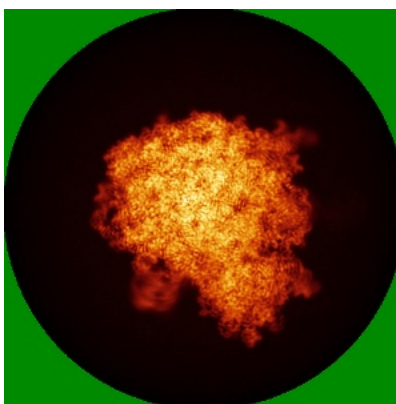

Y



Z

The images above show the map standard deviation projections with false color in three orthogonal directions. Minimum values are shown in green, max in blue, and dark to light orange shades represent small to large values respectively.

6.5 Orthogonal surface views [i](#)

6.5.1 Primary map

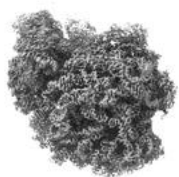

X



Y



Z

The images above show the 3D surface view of the map at the recommended contour level 0.027. These images, in conjunction with the slice images, may facilitate assessment of whether an appropriate contour level has been provided.

6.5.2 Raw map



X

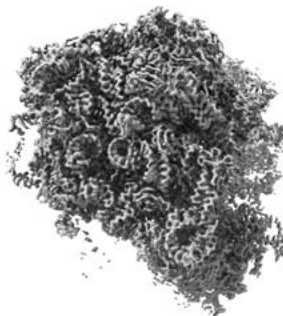

Y

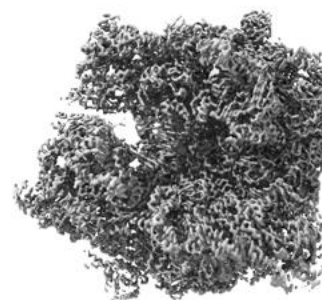

Z

These images show the 3D surface of the raw map. The raw map's contour level was selected so that its surface encloses the same volume as the primary map does at its recommended contour level.

6.6 Mask visualisation [i](#)

This section was not generated. No masks/segmentation were deposited.

7 Map analysis [i](#)

This section contains the results of statistical analysis of the map.

7.1 Map-value distribution [i](#)

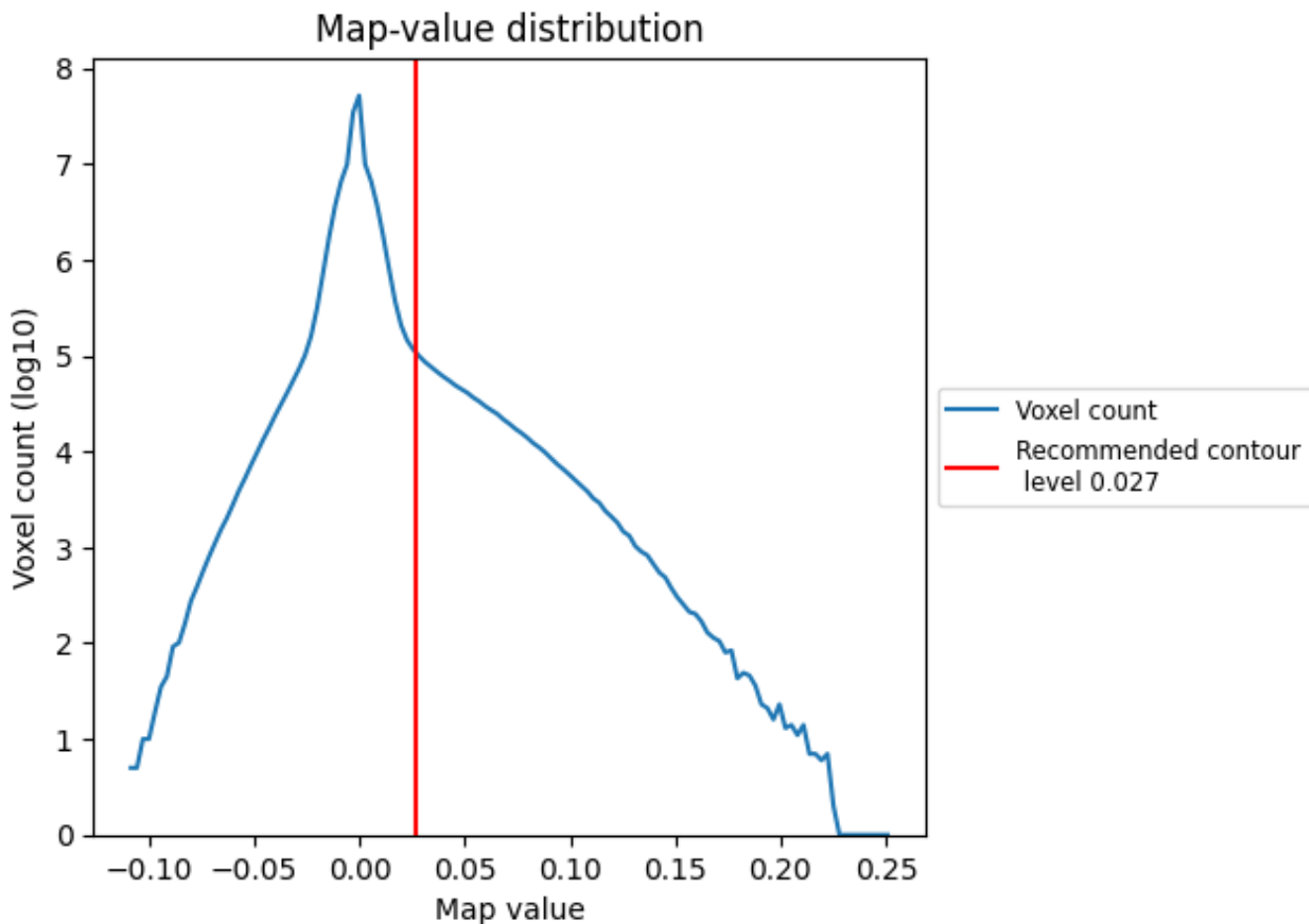

The map-value distribution is plotted in 128 intervals along the x-axis. The y-axis is logarithmic. A spike in this graph at zero usually indicates that the volume has been masked.

7.2 Volume estimate [\(i\)](#)

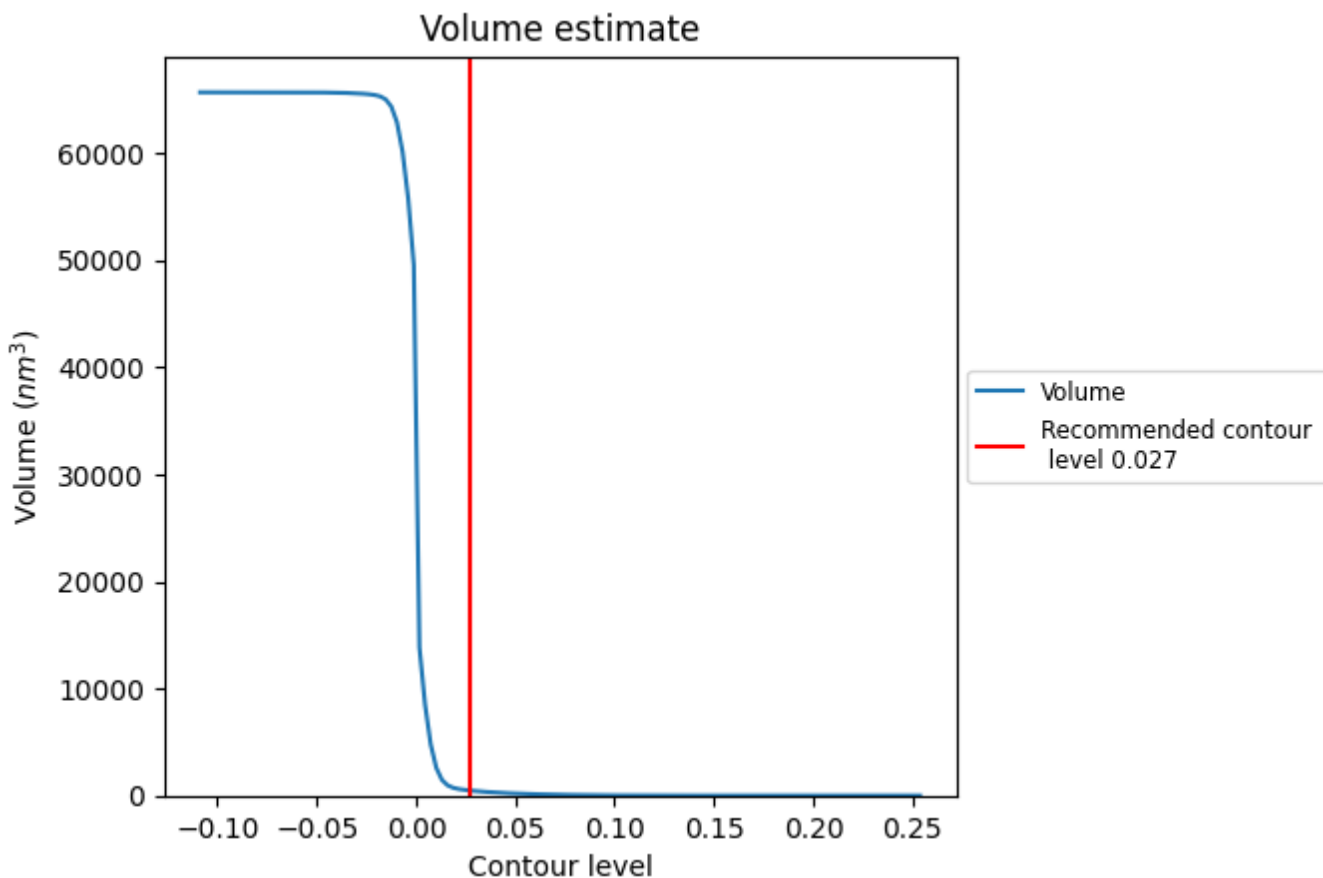

The volume at the recommended contour level is 473 nm³; this corresponds to an approximate mass of 427 kDa.

The volume estimate graph shows how the enclosed volume varies with the contour level. The recommended contour level is shown as a vertical line and the intersection between the line and the curve gives the volume of the enclosed surface at the given level.

7.3 Rotationally averaged power spectrum [i](#)

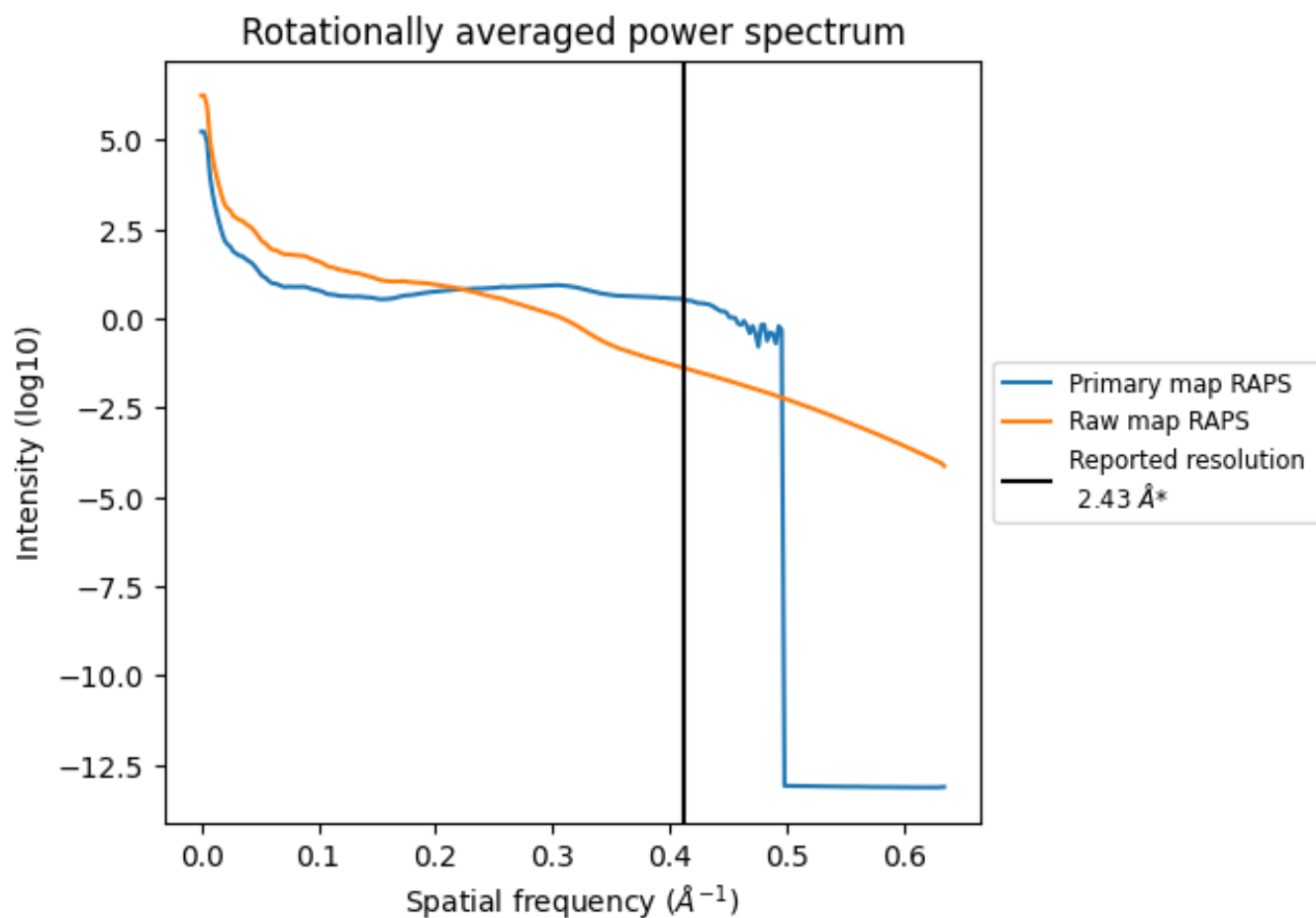

*Reported resolution corresponds to spatial frequency of 0.412 Å⁻¹

8 Fourier-Shell correlation [i](#)

Fourier-Shell Correlation (FSC) is the most commonly used method to estimate the resolution of single-particle and subtomogram-averaged maps. The shape of the curve depends on the imposed symmetry, mask and whether or not the two 3D reconstructions used were processed from a common reference. The reported resolution is shown as a black line. A curve is displayed for the half-bit criterion in addition to lines showing the 0.143 gold standard cut-off and 0.5 cut-off.

8.1 FSC [i](#)

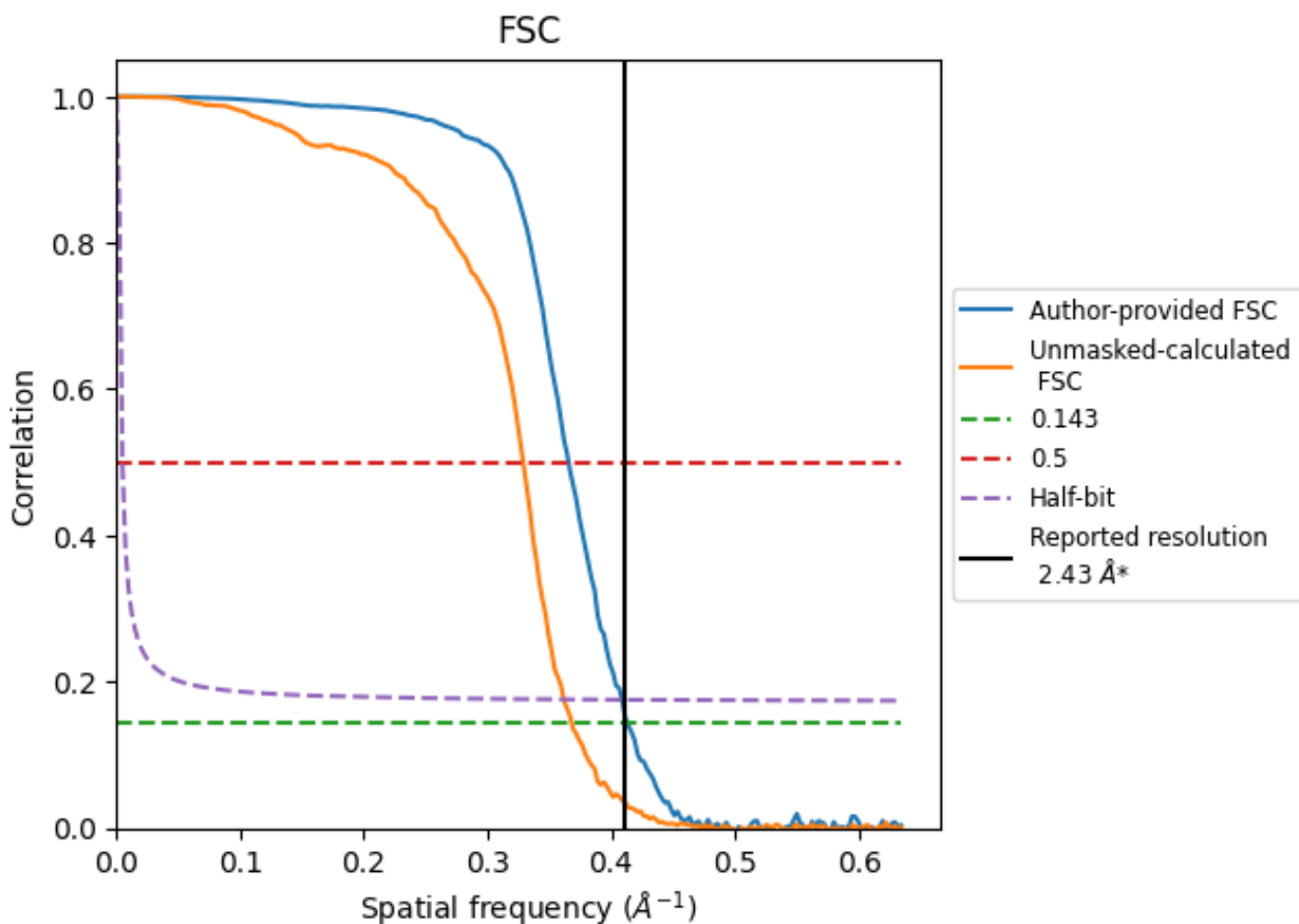

*Reported resolution corresponds to spatial frequency of 0.412 Å⁻¹

8.2 Resolution estimates [i](#)

Resolution estimate (Å)	Estimation criterion (FSC cut-off)		
	0.143	0.5	Half-bit
Reported by author	2.43	-	-
Author-provided FSC curve	2.42	2.74	2.45
Unmasked-calculated*	2.72	3.04	2.76

*Resolution estimate based on FSC curve calculated by comparison of deposited half-maps. The value from deposited half-maps intersecting FSC 0.143 CUT-OFF 2.72 differs from the reported value 2.43 by more than 10 %

9 Map-model fit [i](#)

This section contains information regarding the fit between EMDB map EMD-35411 and PDB model 8IFB. Per-residue inclusion information can be found in section 3 on page 17.

9.1 Map-model overlay [i](#)

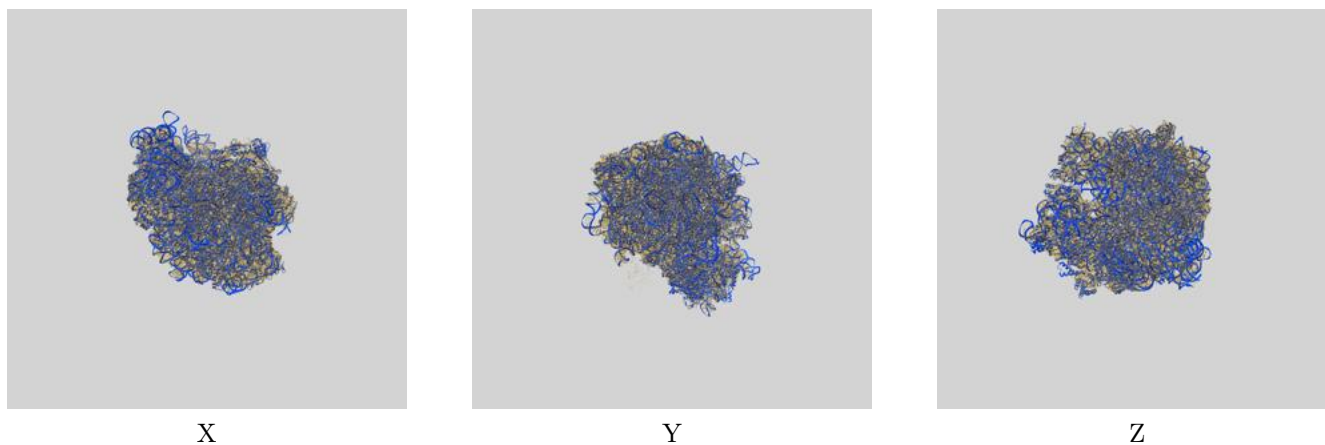

The images above show the 3D surface view of the map at the recommended contour level 0.027 at 50% transparency in yellow overlaid with a ribbon representation of the model coloured in blue. These images allow for the visual assessment of the quality of fit between the atomic model and the map.

9.2 Q-score mapped to coordinate model [i](#)

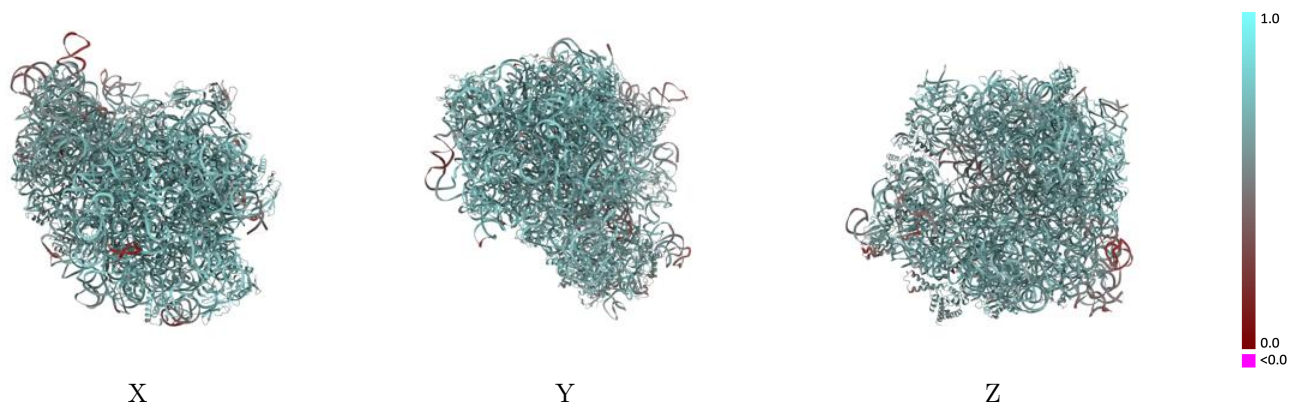

The images above show the model with each residue coloured according to its Q-score. This shows their resolvability in the map with higher Q-score values reflecting better resolvability. Please note: Q-score is calculating the resolvability of atoms, and thus high values are only expected at resolutions at which atoms can be resolved. Low Q-score values may therefore be expected for many entries.

9.3 Atom inclusion mapped to coordinate model [i](#)

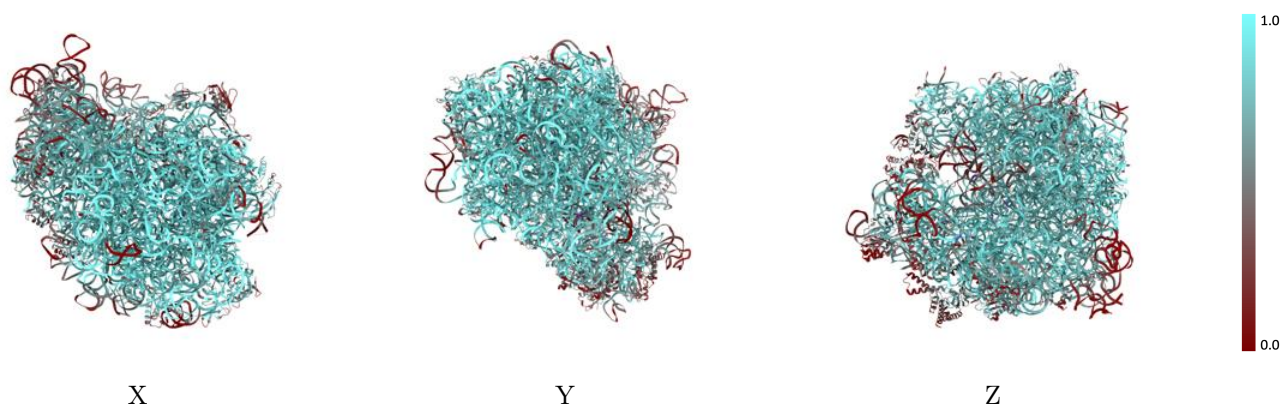

The images above show the model with each residue coloured according to its atom inclusion. This shows to what extent they are inside the map at the recommended contour level (0.027).



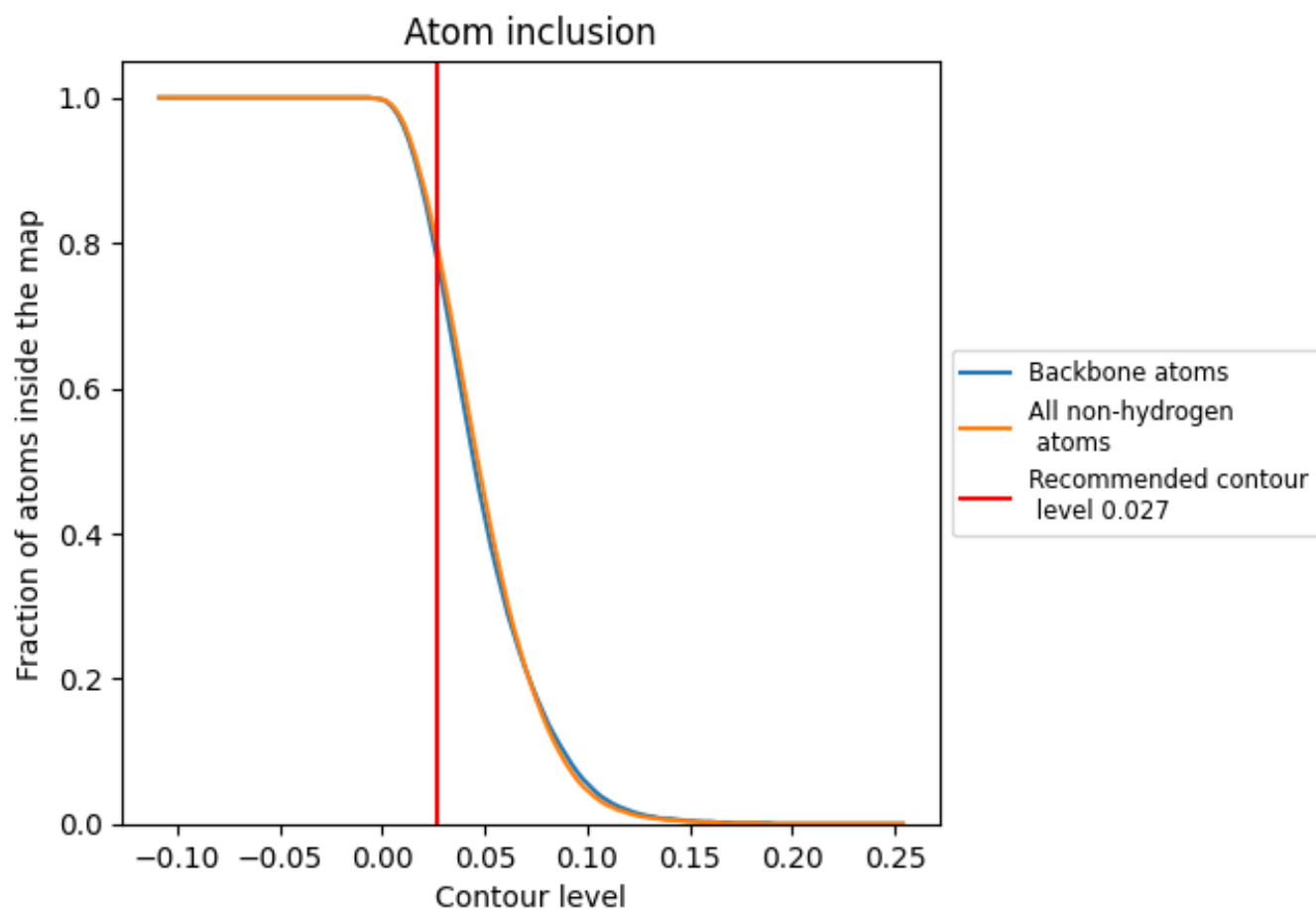



































































9.4 Atom inclusion [i](#)



At the recommended contour level, 77% of all backbone atoms, 79% of all non-hydrogen atoms, are inside the map.

9.5 Map-model fit summary

The table lists the average atom inclusion at the recommended contour level (0.027) and Q-score for the entire model and for each chain.

Chain	Atom inclusion	Q-score
All	 0.7920	 0.6620
0	 0.7730	 0.6750
1	 0.9520	 0.7240
2	 0.9450	 0.7300
3	 0.8360	 0.6930
4	 0.2330	 0.5770
5	 0.5090	 0.5570
6	 0.5410	 0.5700
7	 0.8140	 0.6500
A	 0.7790	 0.6420
B	 0.3970	 0.6030
C	 0.6140	 0.6500
D	 0.4300	 0.6110
E	 0.7520	 0.6750
F	 0.4560	 0.5880
G	 0.4560	 0.5940
H	 0.7390	 0.6680
I	 0.5480	 0.6260
J	 0.4030	 0.5410
K	 0.6940	 0.6550
L	 0.8050	 0.6840
M	 0.5390	 0.6270
N	 0.6490	 0.6450
O	 0.6580	 0.6510
P	 0.5640	 0.6190
Q	 0.6260	 0.6300
R	 0.6080	 0.6260
S	 0.5600	 0.6240
T	 0.5600	 0.6260
U	 0.3760	 0.5620
a	 0.8930	 0.6830
b	 0.8240	 0.6590
c	 0.9030	 0.7150
d	 0.8650	 0.7070
e	 0.7440	 0.6800



Continued on next page...

Continued from previous page...

Chain	Atom inclusion	Q-score
f	0.4890	0.6190
g	0.4350	0.5810
h	0.4900	0.5890
i	0.8760	0.7100
j	0.8500	0.7040
k	0.8210	0.6960
l	0.8650	0.7030
m	0.9420	0.7200
n	0.7210	0.6680
o	0.8030	0.6920
p	0.9250	0.7260
q	0.7730	0.6770
r	0.8590	0.6970
s	0.7370	0.6670
t	0.6370	0.6420
u	0.6900	0.6620
v	0.8830	0.7100
w	0.8540	0.6940
x	0.6030	0.6220
y	0.8420	0.6940
z	0.8330	0.6960