



Full wwPDB X-ray Structure Validation Report ⓘ

Nov 7, 2023 – 07:33 pm GMT

PDB ID : 8BHG
Title : GABA-A receptor $\alpha 5$ heteromer - $\alpha 5V2$ - Bretazenil
Authors : Miller, P.S.; Malinauskas, T.M.; Omari, K.E.; Aricescu, A.R.
Deposited on : 2022-10-31
Resolution : 2.39 Å(reported)

This is a Full wwPDB X-ray Structure Validation Report for a publicly released PDB entry.

We welcome your comments at validation@mail.wwpdb.org

A user guide is available at

<https://www.wwpdb.org/validation/2017/XrayValidationReportHelp>

with specific help available everywhere you see the ⓘ symbol.

The types of validation reports are described at

<http://www.wwpdb.org/validation/2017/FAQs#types>.

The following versions of software and data (see [references ⓘ](#)) were used in the production of this report:

MolProbity : 4.02b-467
Mogul : 1.8.4, CSD as541be (2020)
Xtriage (Phenix) : 1.13
EDS : 2.36
buster-report : 1.1.7 (2018)
Percentile statistics : 20191225.v01 (using entries in the PDB archive December 25th 2019)
Refmac : 5.8.0158
CCP4 : 7.0.044 (Gargrove)
Ideal geometry (proteins) : Engh & Huber (2001)
Ideal geometry (DNA, RNA) : Parkinson et al. (1996)
Validation Pipeline (wwPDB-VP) : 2.36

1 Overall quality at a glance

The following experimental techniques were used to determine the structure:

X-RAY DIFFRACTION

The reported resolution of this entry is 2.39 Å.

Percentile scores (ranging between 0-100) for global validation metrics of the entry are shown in the following graphic. The table shows the number of entries on which the scores are based.

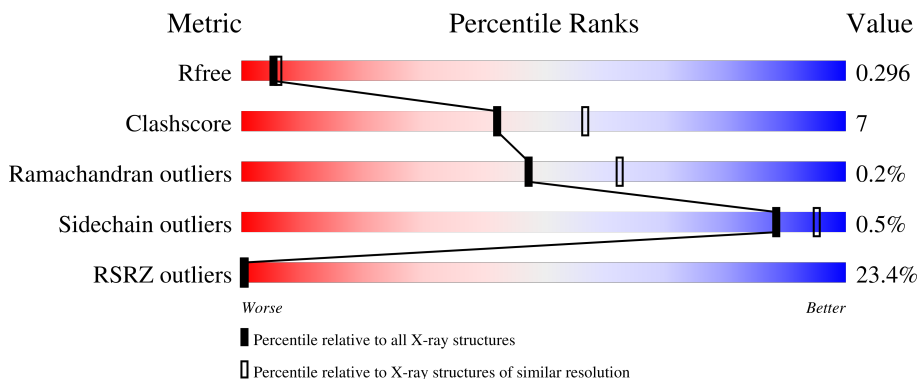

Metric	Whole archive (#Entries)	Similar resolution (#Entries, resolution range(Å))
R_{free}	130704	3907 (2.40-2.40)
Clashscore	141614	4398 (2.40-2.40)
Ramachandran outliers	138981	4318 (2.40-2.40)
Sidechain outliers	138945	4319 (2.40-2.40)
RSRZ outliers	127900	3811 (2.40-2.40)

The table below summarises the geometric issues observed across the polymeric chains and their fit to the electron density. The red, orange, yellow and green segments of the lower bar indicate the fraction of residues that contain outliers for ≥ 3 , 2, 1 and 0 types of geometric quality criteria respectively. A grey segment represents the fraction of residues that are not modelled. The numeric value for each fraction is indicated below the corresponding segment, with a dot representing fractions $\leq 5\%$. The upper red bar (where present) indicates the fraction of residues that have poor fit to the electron density. The numeric value is given above the bar.

Mol	Chain	Length	Quality of chain
1	A	350	
1	C	350	
1	D	350	
1	E	350	
2	B	379	

The following table lists non-polymeric compounds, carbohydrate monomers and non-standard residues in protein, DNA, RNA chains that are outliers for geometric or electron-density-fit criteria:

Mol	Type	Chain	Res	Chirality	Geometry	Clashes	Electron density
6	NAG	A	504	-	-	-	X

2 Entry composition [i](#)

There are 7 unique types of molecules in this entry. The entry contains 27678 atoms, of which 13717 are hydrogens and 0 are deuteriums.

In the tables below, the ZeroOcc column contains the number of atoms modelled with zero occupancy, the AltConf column contains the number of residues with at least one atom in alternate conformation and the Trace column contains the number of residues modelled with at most 2 atoms.

- Molecule 1 is a protein called Gamma-aminobutyric acid receptor subunit alpha-5.

Mol	Chain	Residues	Atoms					ZeroOcc	AltConf	Trace	
			Total	C	H	N	O				S
1	A	336	5377	1750	2665	450	494	18	0	0	0
1	C	334	5355	1740	2659	447	491	18	0	0	0
1	D	335	5374	1746	2670	448	492	18	0	0	0
1	E	336	5388	1750	2676	450	494	18	0	0	0

There are 416 discrepancies between the modelled and reference sequences:

Chain	Residue	Modelled	Actual	Comment	Reference
A	48	MET	ILE	engineered mutation	UNP P31644
A	51	ASN	THR	engineered mutation	UNP P31644
A	67	ILE	VAL	engineered mutation	UNP P31644
A	70	ALA	ARG	engineered mutation	UNP P31644
A	72	THR	SER	engineered mutation	UNP P31644
A	90	ASP	ASN	engineered mutation	UNP P31644
A	92	ARG	LEU	engineered mutation	UNP P31644
A	93	VAL	LEU	engineered mutation	UNP P31644
A	95	ASP	SER	engineered mutation	UNP P31644
A	96	GLN	LYS	engineered mutation	UNP P31644
A	107	ASP	GLY	engineered mutation	UNP P31644
A	111	PHE	ILE	engineered mutation	UNP P31644
A	114	GLY	ASN	conflict	UNP P31644
A	121	MET	LEU	engineered mutation	UNP P31644
A	124	ILE	LEU	engineered mutation	UNP P31644
A	125	TRP	GLU	engineered mutation	UNP P31644
A	126	ASN	ASP	engineered mutation	UNP P31644
A	129	ARG	THR	engineered mutation	UNP P31644
A	130	VAL	LEU	engineered mutation	UNP P31644
A	145	ASP	GLN	engineered mutation	UNP P31644
A	153	GLU	ALA	engineered mutation	UNP P31644

Continued on next page...

Continued from previous page...

Chain	Residue	Modelled	Actual	Comment	Reference
A	154	GLN	HIS	engineered mutation	UNP P31644
A	155	ASN	ALA	engineered mutation	UNP P31644
A	256	ALA	PRO	engineered mutation	UNP P31644
A	305	LEU	ILE	engineered mutation	UNP P31644
A	309	PHE	THR	engineered mutation	UNP P31644
A	313	ILE	PHE	engineered mutation	UNP P31644
A	316	SER	ARG	conflict	UNP P31644
A	317	GLN	GLY	conflict	UNP P31644
A	318	PRO	TRP	conflict	UNP P31644
A	?	-	TRP	deletion	UNP P31644
A	?	-	ASP	deletion	UNP P31644
A	?	-	GLY	deletion	UNP P31644
A	?	-	LYS	deletion	UNP P31644
A	?	-	LYS	deletion	UNP P31644
A	?	-	ALA	deletion	UNP P31644
A	?	-	LEU	deletion	UNP P31644
A	?	-	GLU	deletion	UNP P31644
A	?	-	ALA	deletion	UNP P31644
A	?	-	ALA	deletion	UNP P31644
A	?	-	LYS	deletion	UNP P31644
A	?	-	ILE	deletion	UNP P31644
A	?	-	LYS	deletion	UNP P31644
A	?	-	LYS	deletion	UNP P31644
A	?	-	LYS	deletion	UNP P31644
A	?	-	ARG	deletion	UNP P31644
A	?	-	GLU	deletion	UNP P31644
A	?	-	VAL	deletion	UNP P31644
A	?	-	ILE	deletion	UNP P31644
A	?	-	LEU	deletion	UNP P31644
A	?	-	ASN	deletion	UNP P31644
A	?	-	LYS	deletion	UNP P31644
A	?	-	SER	deletion	UNP P31644
A	?	-	THR	deletion	UNP P31644
A	?	-	ASN	deletion	UNP P31644
A	?	-	ALA	deletion	UNP P31644
A	?	-	PHE	deletion	UNP P31644
A	?	-	THR	deletion	UNP P31644
A	?	-	THR	deletion	UNP P31644
A	?	-	GLY	deletion	UNP P31644
A	?	-	LYS	deletion	UNP P31644
A	?	-	MET	deletion	UNP P31644
A	?	-	SER	deletion	UNP P31644

Continued on next page...

Continued from previous page...

Chain	Residue	Modelled	Actual	Comment	Reference
A	?	-	HIS	deletion	UNP P31644
A	?	-	PRO	deletion	UNP P31644
A	?	-	PRO	deletion	UNP P31644
A	?	-	ASN	deletion	UNP P31644
A	?	-	ILE	deletion	UNP P31644
A	?	-	PRO	deletion	UNP P31644
A	?	-	LYS	deletion	UNP P31644
A	?	-	GLU	deletion	UNP P31644
A	?	-	GLN	deletion	UNP P31644
A	?	-	THR	deletion	UNP P31644
A	?	-	PRO	deletion	UNP P31644
A	?	-	ALA	deletion	UNP P31644
A	?	-	GLY	deletion	UNP P31644
A	?	-	THR	deletion	UNP P31644
A	?	-	SER	deletion	UNP P31644
A	?	-	ASN	deletion	UNP P31644
A	?	-	THR	deletion	UNP P31644
A	?	-	THR	deletion	UNP P31644
A	?	-	SER	deletion	UNP P31644
A	?	-	VAL	deletion	UNP P31644
A	?	-	SER	deletion	UNP P31644
A	?	-	VAL	deletion	UNP P31644
A	?	-	LYS	deletion	UNP P31644
A	?	-	PRO	deletion	UNP P31644
A	?	-	SER	deletion	UNP P31644
A	?	-	GLU	deletion	UNP P31644
A	?	-	GLU	deletion	UNP P31644
A	?	-	LYS	deletion	UNP P31644
A	?	-	THR	deletion	UNP P31644
A	?	-	SER	deletion	UNP P31644
A	?	-	GLU	deletion	UNP P31644
A	?	-	SER	deletion	UNP P31644
A	?	-	LYS	deletion	UNP P31644
A	?	-	LYS	deletion	UNP P31644
A	?	-	THR	deletion	UNP P31644
A	?	-	TYR	deletion	UNP P31644
A	?	-	ASN	deletion	UNP P31644
A	320	ARG	SER	conflict	UNP P31644
A	321	ALA	ILE	conflict	UNP P31644
A	322	ALA	SER	conflict	UNP P31644
A	441	ILE	VAL	conflict	UNP P31644
C	48	MET	ILE	engineered mutation	UNP P31644

Continued on next page...

Continued from previous page...

Chain	Residue	Modelled	Actual	Comment	Reference
C	51	ASN	THR	engineered mutation	UNP P31644
C	67	ILE	VAL	engineered mutation	UNP P31644
C	70	ALA	ARG	engineered mutation	UNP P31644
C	72	THR	SER	engineered mutation	UNP P31644
C	90	ASP	ASN	engineered mutation	UNP P31644
C	92	ARG	LEU	engineered mutation	UNP P31644
C	93	VAL	LEU	engineered mutation	UNP P31644
C	95	ASP	SER	engineered mutation	UNP P31644
C	96	GLN	LYS	engineered mutation	UNP P31644
C	107	ASP	GLY	engineered mutation	UNP P31644
C	111	PHE	ILE	engineered mutation	UNP P31644
C	114	GLY	ASN	conflict	UNP P31644
C	121	MET	LEU	engineered mutation	UNP P31644
C	124	ILE	LEU	engineered mutation	UNP P31644
C	125	TRP	GLU	engineered mutation	UNP P31644
C	126	ASN	ASP	engineered mutation	UNP P31644
C	129	ARG	THR	engineered mutation	UNP P31644
C	130	VAL	LEU	engineered mutation	UNP P31644
C	145	ASP	GLN	engineered mutation	UNP P31644
C	153	GLU	ALA	engineered mutation	UNP P31644
C	154	GLN	HIS	engineered mutation	UNP P31644
C	155	ASN	ALA	engineered mutation	UNP P31644
C	256	ALA	PRO	engineered mutation	UNP P31644
C	305	LEU	ILE	engineered mutation	UNP P31644
C	309	PHE	THR	engineered mutation	UNP P31644
C	313	ILE	PHE	engineered mutation	UNP P31644
C	316	SER	ARG	conflict	UNP P31644
C	317	GLN	GLY	conflict	UNP P31644
C	318	PRO	TRP	conflict	UNP P31644
C	?	-	TRP	deletion	UNP P31644
C	?	-	ASP	deletion	UNP P31644
C	?	-	GLY	deletion	UNP P31644
C	?	-	LYS	deletion	UNP P31644
C	?	-	LYS	deletion	UNP P31644
C	?	-	ALA	deletion	UNP P31644
C	?	-	LEU	deletion	UNP P31644
C	?	-	GLU	deletion	UNP P31644
C	?	-	ALA	deletion	UNP P31644
C	?	-	ALA	deletion	UNP P31644
C	?	-	LYS	deletion	UNP P31644
C	?	-	ILE	deletion	UNP P31644
C	?	-	LYS	deletion	UNP P31644

Continued on next page...

Continued from previous page...

Chain	Residue	Modelled	Actual	Comment	Reference
C	?	-	LYS	deletion	UNP P31644
C	?	-	LYS	deletion	UNP P31644
C	?	-	ARG	deletion	UNP P31644
C	?	-	GLU	deletion	UNP P31644
C	?	-	VAL	deletion	UNP P31644
C	?	-	ILE	deletion	UNP P31644
C	?	-	LEU	deletion	UNP P31644
C	?	-	ASN	deletion	UNP P31644
C	?	-	LYS	deletion	UNP P31644
C	?	-	SER	deletion	UNP P31644
C	?	-	THR	deletion	UNP P31644
C	?	-	ASN	deletion	UNP P31644
C	?	-	ALA	deletion	UNP P31644
C	?	-	PHE	deletion	UNP P31644
C	?	-	THR	deletion	UNP P31644
C	?	-	THR	deletion	UNP P31644
C	?	-	GLY	deletion	UNP P31644
C	?	-	LYS	deletion	UNP P31644
C	?	-	MET	deletion	UNP P31644
C	?	-	SER	deletion	UNP P31644
C	?	-	HIS	deletion	UNP P31644
C	?	-	PRO	deletion	UNP P31644
C	?	-	PRO	deletion	UNP P31644
C	?	-	ASN	deletion	UNP P31644
C	?	-	ILE	deletion	UNP P31644
C	?	-	PRO	deletion	UNP P31644
C	?	-	LYS	deletion	UNP P31644
C	?	-	GLU	deletion	UNP P31644
C	?	-	GLN	deletion	UNP P31644
C	?	-	THR	deletion	UNP P31644
C	?	-	PRO	deletion	UNP P31644
C	?	-	ALA	deletion	UNP P31644
C	?	-	GLY	deletion	UNP P31644
C	?	-	THR	deletion	UNP P31644
C	?	-	SER	deletion	UNP P31644
C	?	-	ASN	deletion	UNP P31644
C	?	-	THR	deletion	UNP P31644
C	?	-	THR	deletion	UNP P31644
C	?	-	SER	deletion	UNP P31644
C	?	-	VAL	deletion	UNP P31644
C	?	-	SER	deletion	UNP P31644
C	?	-	VAL	deletion	UNP P31644

Continued on next page...

Continued from previous page...

Chain	Residue	Modelled	Actual	Comment	Reference
C	?	-	LYS	deletion	UNP P31644
C	?	-	PRO	deletion	UNP P31644
C	?	-	SER	deletion	UNP P31644
C	?	-	GLU	deletion	UNP P31644
C	?	-	GLU	deletion	UNP P31644
C	?	-	LYS	deletion	UNP P31644
C	?	-	THR	deletion	UNP P31644
C	?	-	SER	deletion	UNP P31644
C	?	-	GLU	deletion	UNP P31644
C	?	-	SER	deletion	UNP P31644
C	?	-	LYS	deletion	UNP P31644
C	?	-	LYS	deletion	UNP P31644
C	?	-	THR	deletion	UNP P31644
C	?	-	TYR	deletion	UNP P31644
C	?	-	ASN	deletion	UNP P31644
C	320	ARG	SER	conflict	UNP P31644
C	321	ALA	ILE	conflict	UNP P31644
C	322	ALA	SER	conflict	UNP P31644
C	441	ILE	VAL	conflict	UNP P31644
D	48	MET	ILE	engineered mutation	UNP P31644
D	51	ASN	THR	engineered mutation	UNP P31644
D	67	ILE	VAL	engineered mutation	UNP P31644
D	70	ALA	ARG	engineered mutation	UNP P31644
D	72	THR	SER	engineered mutation	UNP P31644
D	90	ASP	ASN	engineered mutation	UNP P31644
D	92	ARG	LEU	engineered mutation	UNP P31644
D	93	VAL	LEU	engineered mutation	UNP P31644
D	95	ASP	SER	engineered mutation	UNP P31644
D	96	GLN	LYS	engineered mutation	UNP P31644
D	107	ASP	GLY	engineered mutation	UNP P31644
D	111	PHE	ILE	engineered mutation	UNP P31644
D	114	GLY	ASN	conflict	UNP P31644
D	121	MET	LEU	engineered mutation	UNP P31644
D	124	ILE	LEU	engineered mutation	UNP P31644
D	125	TRP	GLU	engineered mutation	UNP P31644
D	126	ASN	ASP	engineered mutation	UNP P31644
D	129	ARG	THR	engineered mutation	UNP P31644
D	130	VAL	LEU	engineered mutation	UNP P31644
D	145	ASP	GLN	engineered mutation	UNP P31644
D	153	GLU	ALA	engineered mutation	UNP P31644
D	154	GLN	HIS	engineered mutation	UNP P31644
D	155	ASN	ALA	engineered mutation	UNP P31644

Continued on next page...

Continued from previous page...

Chain	Residue	Modelled	Actual	Comment	Reference
D	256	ALA	PRO	engineered mutation	UNP P31644
D	305	LEU	ILE	engineered mutation	UNP P31644
D	309	PHE	THR	engineered mutation	UNP P31644
D	313	ILE	PHE	engineered mutation	UNP P31644
D	316	SER	ARG	conflict	UNP P31644
D	317	GLN	GLY	conflict	UNP P31644
D	318	PRO	TRP	conflict	UNP P31644
D	?	-	TRP	deletion	UNP P31644
D	?	-	ASP	deletion	UNP P31644
D	?	-	GLY	deletion	UNP P31644
D	?	-	LYS	deletion	UNP P31644
D	?	-	LYS	deletion	UNP P31644
D	?	-	ALA	deletion	UNP P31644
D	?	-	LEU	deletion	UNP P31644
D	?	-	GLU	deletion	UNP P31644
D	?	-	ALA	deletion	UNP P31644
D	?	-	ALA	deletion	UNP P31644
D	?	-	LYS	deletion	UNP P31644
D	?	-	ILE	deletion	UNP P31644
D	?	-	LYS	deletion	UNP P31644
D	?	-	LYS	deletion	UNP P31644
D	?	-	LYS	deletion	UNP P31644
D	?	-	ARG	deletion	UNP P31644
D	?	-	GLU	deletion	UNP P31644
D	?	-	VAL	deletion	UNP P31644
D	?	-	ILE	deletion	UNP P31644
D	?	-	LEU	deletion	UNP P31644
D	?	-	ASN	deletion	UNP P31644
D	?	-	LYS	deletion	UNP P31644
D	?	-	SER	deletion	UNP P31644
D	?	-	THR	deletion	UNP P31644
D	?	-	ASN	deletion	UNP P31644
D	?	-	ALA	deletion	UNP P31644
D	?	-	PHE	deletion	UNP P31644
D	?	-	THR	deletion	UNP P31644
D	?	-	THR	deletion	UNP P31644
D	?	-	GLY	deletion	UNP P31644
D	?	-	LYS	deletion	UNP P31644
D	?	-	MET	deletion	UNP P31644
D	?	-	SER	deletion	UNP P31644
D	?	-	HIS	deletion	UNP P31644
D	?	-	PRO	deletion	UNP P31644

Continued on next page...

Continued from previous page...

Chain	Residue	Modelled	Actual	Comment	Reference
D	?	-	PRO	deletion	UNP P31644
D	?	-	ASN	deletion	UNP P31644
D	?	-	ILE	deletion	UNP P31644
D	?	-	PRO	deletion	UNP P31644
D	?	-	LYS	deletion	UNP P31644
D	?	-	GLU	deletion	UNP P31644
D	?	-	GLN	deletion	UNP P31644
D	?	-	THR	deletion	UNP P31644
D	?	-	PRO	deletion	UNP P31644
D	?	-	ALA	deletion	UNP P31644
D	?	-	GLY	deletion	UNP P31644
D	?	-	THR	deletion	UNP P31644
D	?	-	SER	deletion	UNP P31644
D	?	-	ASN	deletion	UNP P31644
D	?	-	THR	deletion	UNP P31644
D	?	-	THR	deletion	UNP P31644
D	?	-	SER	deletion	UNP P31644
D	?	-	VAL	deletion	UNP P31644
D	?	-	SER	deletion	UNP P31644
D	?	-	VAL	deletion	UNP P31644
D	?	-	LYS	deletion	UNP P31644
D	?	-	PRO	deletion	UNP P31644
D	?	-	SER	deletion	UNP P31644
D	?	-	GLU	deletion	UNP P31644
D	?	-	GLU	deletion	UNP P31644
D	?	-	LYS	deletion	UNP P31644
D	?	-	THR	deletion	UNP P31644
D	?	-	SER	deletion	UNP P31644
D	?	-	GLU	deletion	UNP P31644
D	?	-	SER	deletion	UNP P31644
D	?	-	LYS	deletion	UNP P31644
D	?	-	LYS	deletion	UNP P31644
D	?	-	THR	deletion	UNP P31644
D	?	-	TYR	deletion	UNP P31644
D	?	-	ASN	deletion	UNP P31644
D	320	ARG	SER	conflict	UNP P31644
D	321	ALA	ILE	conflict	UNP P31644
D	322	ALA	SER	conflict	UNP P31644
D	441	ILE	VAL	conflict	UNP P31644
E	48	MET	ILE	engineered mutation	UNP P31644
E	51	ASN	THR	engineered mutation	UNP P31644
E	67	ILE	VAL	engineered mutation	UNP P31644

Continued on next page...

Continued from previous page...

Chain	Residue	Modelled	Actual	Comment	Reference
E	70	ALA	ARG	engineered mutation	UNP P31644
E	72	THR	SER	engineered mutation	UNP P31644
E	90	ASP	ASN	engineered mutation	UNP P31644
E	92	ARG	LEU	engineered mutation	UNP P31644
E	93	VAL	LEU	engineered mutation	UNP P31644
E	95	ASP	SER	engineered mutation	UNP P31644
E	96	GLN	LYS	engineered mutation	UNP P31644
E	107	ASP	GLY	engineered mutation	UNP P31644
E	111	PHE	ILE	engineered mutation	UNP P31644
E	114	GLY	ASN	conflict	UNP P31644
E	121	MET	LEU	engineered mutation	UNP P31644
E	124	ILE	LEU	engineered mutation	UNP P31644
E	125	TRP	GLU	engineered mutation	UNP P31644
E	126	ASN	ASP	engineered mutation	UNP P31644
E	129	ARG	THR	engineered mutation	UNP P31644
E	130	VAL	LEU	engineered mutation	UNP P31644
E	145	ASP	GLN	engineered mutation	UNP P31644
E	153	GLU	ALA	engineered mutation	UNP P31644
E	154	GLN	HIS	engineered mutation	UNP P31644
E	155	ASN	ALA	engineered mutation	UNP P31644
E	256	ALA	PRO	engineered mutation	UNP P31644
E	305	LEU	ILE	engineered mutation	UNP P31644
E	309	PHE	THR	engineered mutation	UNP P31644
E	313	ILE	PHE	engineered mutation	UNP P31644
E	316	SER	ARG	conflict	UNP P31644
E	317	GLN	GLY	conflict	UNP P31644
E	318	PRO	TRP	conflict	UNP P31644
E	?	-	TRP	deletion	UNP P31644
E	?	-	ASP	deletion	UNP P31644
E	?	-	GLY	deletion	UNP P31644
E	?	-	LYS	deletion	UNP P31644
E	?	-	LYS	deletion	UNP P31644
E	?	-	ALA	deletion	UNP P31644
E	?	-	LEU	deletion	UNP P31644
E	?	-	GLU	deletion	UNP P31644
E	?	-	ALA	deletion	UNP P31644
E	?	-	ALA	deletion	UNP P31644
E	?	-	LYS	deletion	UNP P31644
E	?	-	ILE	deletion	UNP P31644
E	?	-	LYS	deletion	UNP P31644
E	?	-	LYS	deletion	UNP P31644
E	?	-	LYS	deletion	UNP P31644

Continued on next page...

Continued from previous page...

Chain	Residue	Modelled	Actual	Comment	Reference
E	?	-	ARG	deletion	UNP P31644
E	?	-	GLU	deletion	UNP P31644
E	?	-	VAL	deletion	UNP P31644
E	?	-	ILE	deletion	UNP P31644
E	?	-	LEU	deletion	UNP P31644
E	?	-	ASN	deletion	UNP P31644
E	?	-	LYS	deletion	UNP P31644
E	?	-	SER	deletion	UNP P31644
E	?	-	THR	deletion	UNP P31644
E	?	-	ASN	deletion	UNP P31644
E	?	-	ALA	deletion	UNP P31644
E	?	-	PHE	deletion	UNP P31644
E	?	-	THR	deletion	UNP P31644
E	?	-	THR	deletion	UNP P31644
E	?	-	GLY	deletion	UNP P31644
E	?	-	LYS	deletion	UNP P31644
E	?	-	MET	deletion	UNP P31644
E	?	-	SER	deletion	UNP P31644
E	?	-	HIS	deletion	UNP P31644
E	?	-	PRO	deletion	UNP P31644
E	?	-	PRO	deletion	UNP P31644
E	?	-	ASN	deletion	UNP P31644
E	?	-	ILE	deletion	UNP P31644
E	?	-	PRO	deletion	UNP P31644
E	?	-	LYS	deletion	UNP P31644
E	?	-	GLU	deletion	UNP P31644
E	?	-	GLN	deletion	UNP P31644
E	?	-	THR	deletion	UNP P31644
E	?	-	PRO	deletion	UNP P31644
E	?	-	ALA	deletion	UNP P31644
E	?	-	GLY	deletion	UNP P31644
E	?	-	THR	deletion	UNP P31644
E	?	-	SER	deletion	UNP P31644
E	?	-	ASN	deletion	UNP P31644
E	?	-	THR	deletion	UNP P31644
E	?	-	THR	deletion	UNP P31644
E	?	-	SER	deletion	UNP P31644
E	?	-	VAL	deletion	UNP P31644
E	?	-	SER	deletion	UNP P31644
E	?	-	VAL	deletion	UNP P31644
E	?	-	LYS	deletion	UNP P31644
E	?	-	PRO	deletion	UNP P31644

Continued on next page...

Continued from previous page...

Chain	Residue	Modelled	Actual	Comment	Reference
E	?	-	SER	deletion	UNP P31644
E	?	-	GLU	deletion	UNP P31644
E	?	-	GLU	deletion	UNP P31644
E	?	-	LYS	deletion	UNP P31644
E	?	-	THR	deletion	UNP P31644
E	?	-	SER	deletion	UNP P31644
E	?	-	GLU	deletion	UNP P31644
E	?	-	SER	deletion	UNP P31644
E	?	-	LYS	deletion	UNP P31644
E	?	-	LYS	deletion	UNP P31644
E	?	-	THR	deletion	UNP P31644
E	?	-	TYR	deletion	UNP P31644
E	?	-	ASN	deletion	UNP P31644
E	320	ARG	SER	conflict	UNP P31644
E	321	ALA	ILE	conflict	UNP P31644
E	322	ALA	SER	conflict	UNP P31644
E	441	ILE	VAL	conflict	UNP P31644

- Molecule 2 is a protein called Gamma-aminobutyric acid receptor subunit gamma-2.

Mol	Chain	Residues	Atoms					ZeroOcc	AltConf	Trace	
			Total	C	H	N	O				S
2	B	334	5459	1780	2722	456	488	13	0	1	0

There are 78 discrepancies between the modelled and reference sequences:

Chain	Residue	Modelled	Actual	Comment	Reference
B	11	THR	ALA	conflict	UNP P18507
B	233	ILE	MET	conflict	UNP P18507
B	237	VAL	THR	conflict	UNP P18507
B	242	LEU	ILE	conflict	UNP P18507
B	245	ILE	THR	conflict	UNP P18507
B	246	MET	LEU	conflict	UNP P18507
B	247	THR	ILE	conflict	UNP P18507
B	249	ILE	VAL	conflict	UNP P18507
B	252	GLN	TRP	conflict	UNP P18507
B	257	LEU	ILE	conflict	UNP P18507
B	259	ARG	LYS	conflict	UNP P18507
B	260	GLU	ASP	conflict	UNP P18507
B	261	SER	ALA	conflict	UNP P18507
B	263	ALA	PRO	conflict	UNP P18507
B	267	VAL	SER	conflict	UNP P18507

Continued on next page...

Continued from previous page...

Chain	Residue	Modelled	Actual	Comment	Reference
B	268	PHE	LEU	conflict	UNP P18507
B	270	VAL	ILE	conflict	UNP P18507
B	281	ILE	THR	conflict	UNP P18507
B	282	SER	ILE	conflict	UNP P18507
B	285	ASN	LYS	conflict	UNP P18507
B	291	ALA	SER	conflict	UNP P18507
B	293	ALA	VAL	conflict	UNP P18507
B	298	TRP	LEU	conflict	UNP P18507
B	300	ILE	VAL	conflict	UNP P18507
B	301	ALA	SER	conflict	UNP P18507
B	304	TYR	PHE	conflict	UNP P18507
B	305	ALA	ILE	conflict	UNP P18507
B	312	ILE	VAL	conflict	UNP P18507
B	314	PHE	TYR	conflict	UNP P18507
B	315	ALA	GLY	conflict	UNP P18507
B	317	VAL	LEU	conflict	UNP P18507
B	318	ASN	HIS	conflict	UNP P18507
B	321	THR	-	insertion	UNP P18507
B	322	LYS	VAL	conflict	UNP P18507
B	324	GLN	-	insertion	UNP P18507
B	325	PRO	-	insertion	UNP P18507
B	326	ALA	ASN	conflict	UNP P18507
B	328	ALA	LYS	conflict	UNP P18507
B	329	ALA	PRO	conflict	UNP P18507
B	330	LYS	SER	conflict	UNP P18507
B	438	ILE	LYS	conflict	UNP P18507
B	440	ARG	LYS	conflict	UNP P18507
B	441	LEU	ASP	conflict	UNP P18507
B	442	SER	LYS	conflict	UNP P18507
B	443	ARG	LYS	conflict	UNP P18507
B	444	ILE	LYS	conflict	UNP P18507
B	445	ALA	LYS	conflict	UNP P18507
B	446	PHE	ASN	conflict	UNP P18507
B	450	PHE	-	insertion	UNP P18507
B	451	GLY	ARG	conflict	UNP P18507
B	452	ILE	MET	conflict	UNP P18507
B	454	ASN	-	insertion	UNP P18507
B	455	LEU	SER	conflict	UNP P18507
B	456	VAL	PHE	conflict	UNP P18507
B	457	TYR	LYS	conflict	UNP P18507
B	458	TRP	ALA	conflict	UNP P18507
B	459	ALA	PRO	conflict	UNP P18507

Continued on next page...

Continued from previous page...

Chain	Residue	Modelled	Actual	Comment	Reference
B	461	TYR	ILE	conflict	UNP P18507
B	462	LEU	ASP	conflict	UNP P18507
B	463	ASN	ILE	conflict	UNP P18507
B	465	GLU	-	insertion	UNP P18507
B	467	GLN	-	insertion	UNP P18507
B	468	LEU	-	insertion	UNP P18507
B	469	LYS	ARG	conflict	UNP P18507
B	470	ALA	SER	conflict	UNP P18507
B	471	PRO	ALA	conflict	UNP P18507
B	473	PRO	-	insertion	UNP P18507
B	474	HIS	ILE	conflict	UNP P18507
B	476	GLY	MET	conflict	UNP P18507
B	477	THR	ASN	conflict	UNP P18507
B	478	THR	ASN	conflict	UNP P18507
B	479	GLU	ALA	conflict	UNP P18507
B	481	SER	HIS	conflict	UNP P18507
B	482	GLN	LEU	conflict	UNP P18507
B	483	VAL	GLN	conflict	UNP P18507
B	484	ALA	GLU	conflict	UNP P18507
B	485	PRO	ARG	conflict	UNP P18507
B	486	ALA	ASP	conflict	UNP P18507

- Molecule 3 is Bretazenil (three-letter code: QMU) (formula: $C_{19}H_{20}BrN_3O_3$) (labeled as "Ligand of Interest" by depositor).

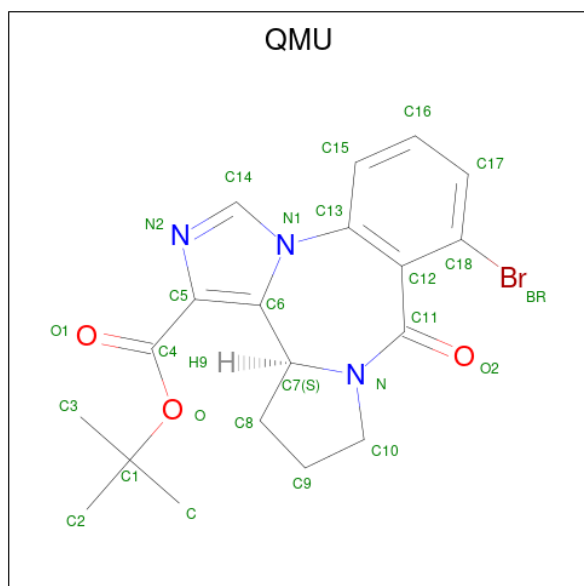

Mol	Chain	Residues	Atoms						ZeroOcc	AltConf
			Total	Br	C	H	N	O		
3	A	1	46	1	19	20	3	3	0	0
3	B	1	46	1	19	20	3	3	0	0
3	B	1	46	1	19	20	3	3	0	0
3	D	1	46	1	19	20	3	3	0	0
3	D	1	46	1	19	20	3	3	0	0

- Molecule 4 is DECYL-BETA-D-MALTOPYRANOSIDE (three-letter code: DMU) (formula: $C_{22}H_{42}O_{11}$).

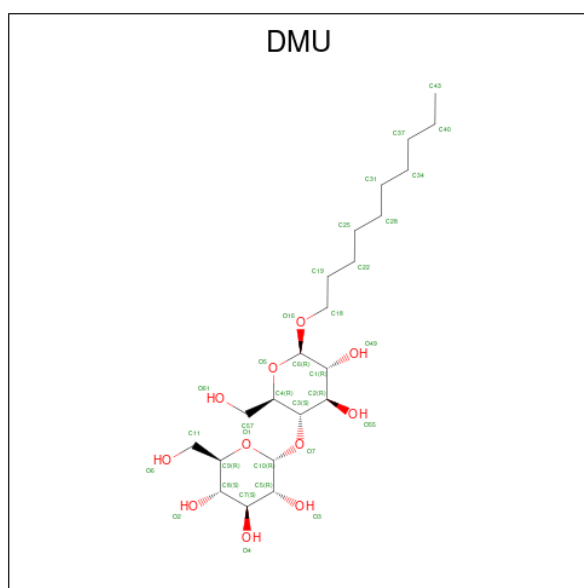

Mol	Chain	Residues	Atoms				ZeroOcc	AltConf
			Total	C	H	O		
4	A	1	59	17	31	11	0	0
4	B	1	75	22	42	11	0	0
4	C	1	75	22	42	11	0	0
4	D	1	75	22	42	11	0	0
4	E	1	75	22	42	11	0	0

- Molecule 5 is NITRATE ION (three-letter code: NO3) (formula: NO_3).

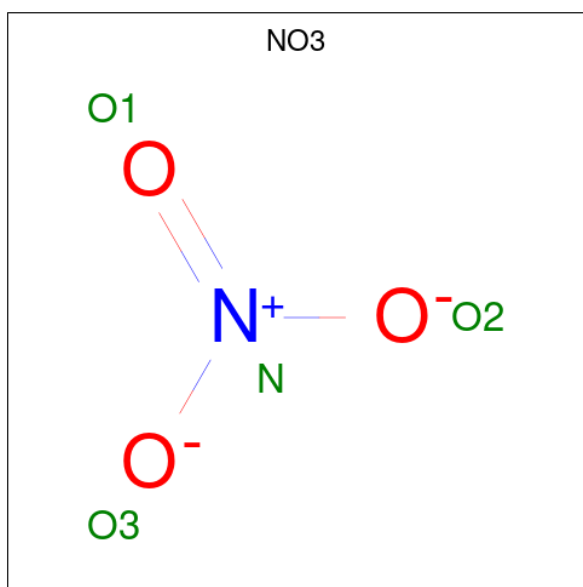

Mol	Chain	Residues	Atoms			ZeroOcc	AltConf
5	A	1	Total	N	O	0	0
			4	1	3		
5	B	1	Total	N	O	0	0
			4	1	3		
5	C	1	Total	N	O	0	0
			4	1	3		

- Molecule 6 is 2-acetamido-2-deoxy-beta-D-glucopyranose (three-letter code: NAG) (formula: $C_8H_{15}NO_6$).

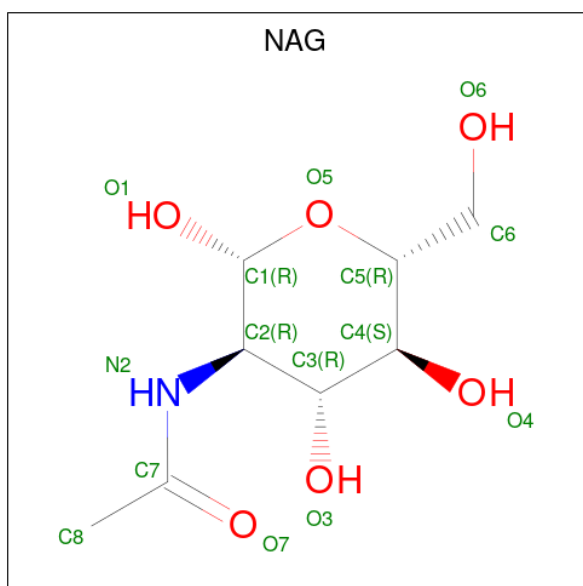

Mol	Chain	Residues	Atoms	ZeroOcc	AltConf
6	A	1	Total C N O 14 8 1 5	0	0
6	B	1	Total C H N O 27 8 13 1 5	0	0
6	B	1	Total C N O 14 8 1 5	0	0
6	C	1	Total C H N O 27 8 13 1 5	0	0
6	D	1	Total C N O 14 8 1 5	0	0
6	E	1	Total C N O 14 8 1 5	0	0

- Molecule 7 is water.

Mol	Chain	Residues	Atoms	ZeroOcc	AltConf
7	A	3	Total O 3 3	0	0
7	B	4	Total O 4 4	0	0
7	C	4	Total O 4 4	0	0
7	D	2	Total O 2 2	0	0
7	E	1	Total O 1 1	0	0

3 Residue-property plots [i](#)

These plots are drawn for all protein, RNA, DNA and oligosaccharide chains in the entry. The first graphic for a chain summarises the proportions of the various outlier classes displayed in the second graphic. The second graphic shows the sequence view annotated by issues in geometry and electron density. Residues are color-coded according to the number of geometric quality criteria for which they contain at least one outlier: green = 0, yellow = 1, orange = 2 and red = 3 or more. A red dot above a residue indicates a poor fit to the electron density ($RSRZ > 2$). Stretches of 2 or more consecutive residues without any outlier are shown as a green connector. Residues present in the sample, but not in the model, are shown in grey.

- Molecule 1: Gamma-aminobutyric acid receptor subunit alpha-5

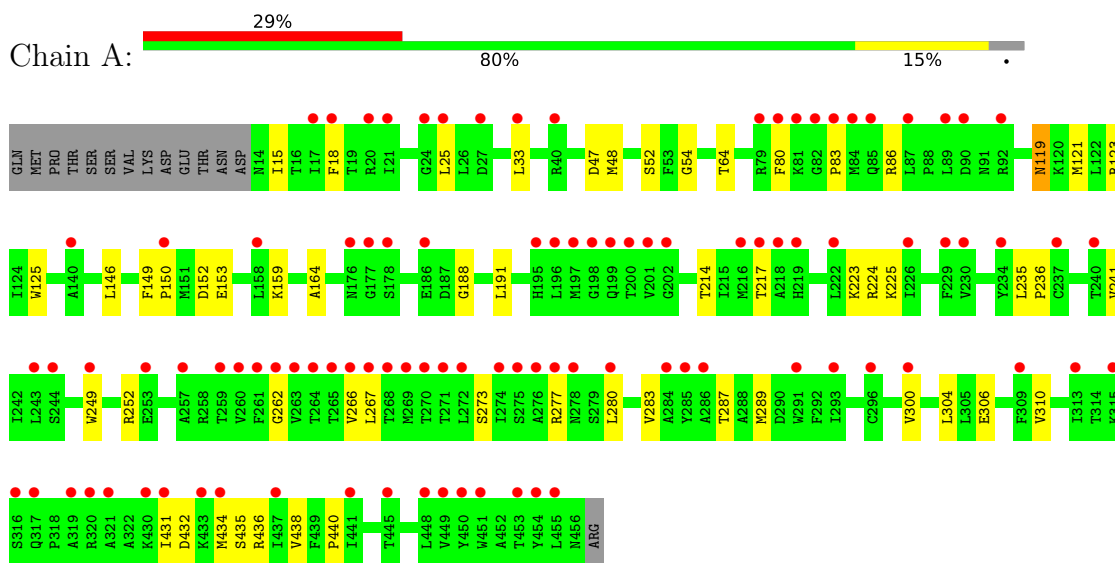

- Molecule 1: Gamma-aminobutyric acid receptor subunit alpha-5

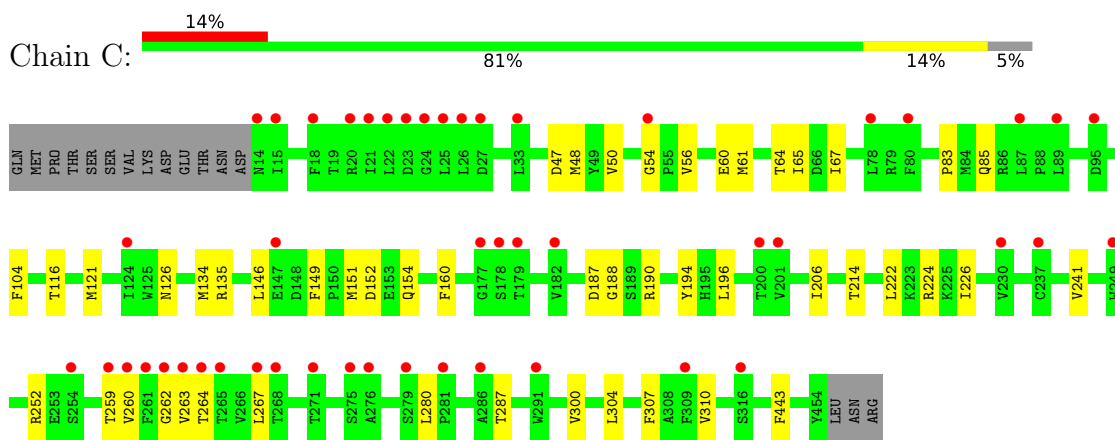

- Molecule 1: Gamma-aminobutyric acid receptor subunit alpha-5

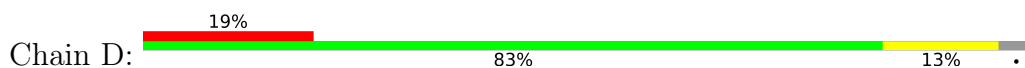

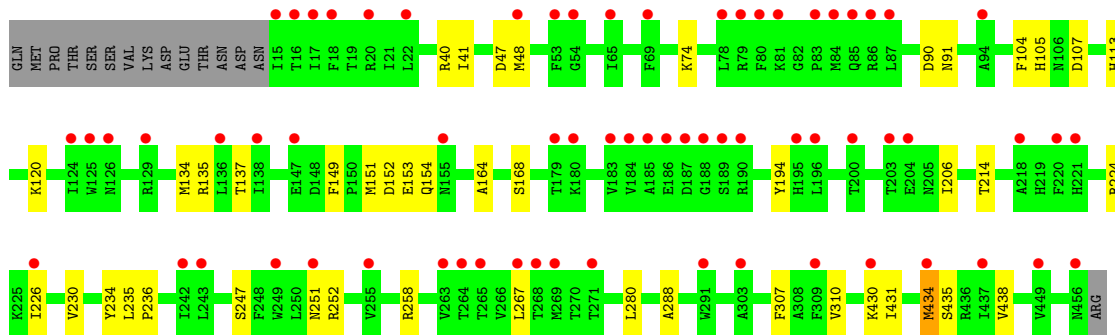

• Molecule 1: Gamma-aminobutyric acid receptor subunit alpha-5

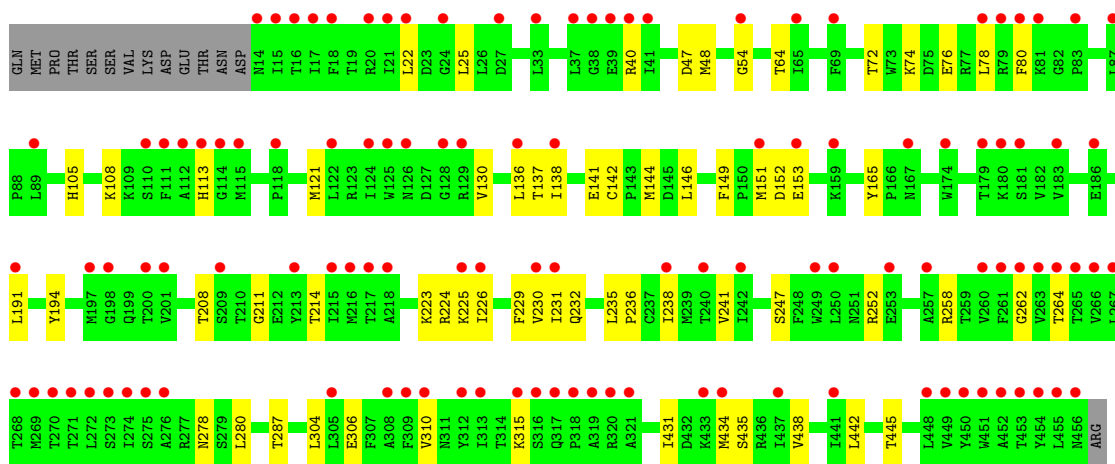
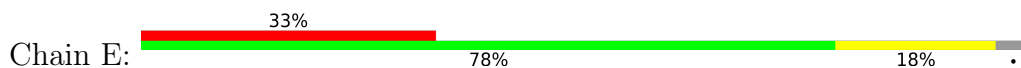

• Molecule 2: Gamma-aminobutyric acid receptor subunit gamma-2

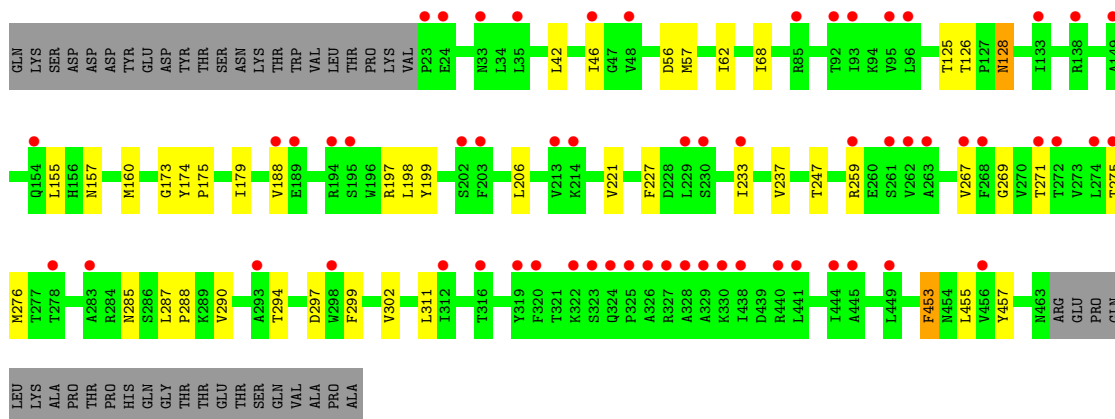
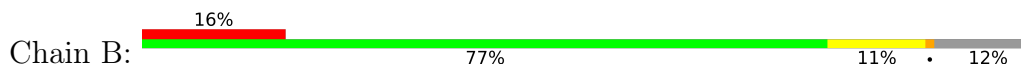

4 Data and refinement statistics

Property	Value	Source
Space group	P 1 21 1	Depositor
Cell constants a, b, c, α , β , γ	81.14Å 137.64Å 113.35Å 90.00° 106.06° 90.00°	Depositor
Resolution (Å)	48.56 – 2.39 48.56 – 2.39	Depositor EDS
% Data completeness (in resolution range)	91.2 (48.56-2.39) 46.1 (48.56-2.39)	Depositor EDS
R_{merge}	0.18	Depositor
R_{sym}	(Not available)	Depositor
$\langle I/\sigma(I) \rangle$ ¹	1.36 (at 2.39Å)	Xtrriage
Refinement program	REFMAC 1.20.1_4487, PHENIX 1.20.1_4487	Depositor
R, R_{free}	0.257 , 0.283 0.277 , 0.296	Depositor DCC
R_{free} test set	2207 reflections (5.09%)	wwPDB-VP
Wilson B-factor (Å ²)	41.3	Xtrriage
Anisotropy	0.057	Xtrriage
Bulk solvent k_{sol} (e/Å ³), B_{sol} (Å ²)	0.31 , 19.2	EDS
L-test for twinning ²	$\langle L \rangle = 0.44$, $\langle L^2 \rangle = 0.27$	Xtrriage
Estimated twinning fraction	No twinning to report.	Xtrriage
F_o, F_c correlation	0.82	EDS
Total number of atoms	27678	wwPDB-VP
Average B, all atoms (Å ²)	64.0	wwPDB-VP

Xtrriage's analysis on translational NCS is as follows: *The largest off-origin peak in the Patterson function is 4.33% of the height of the origin peak. No significant pseudotranslation is detected.*

¹Intensities estimated from amplitudes.

²Theoretical values of $\langle |L| \rangle$, $\langle L^2 \rangle$ for acentric reflections are 0.5, 0.333 respectively for untwinned datasets, and 0.375, 0.2 for perfectly twinned datasets.

5 Model quality [i](#)

5.1 Standard geometry [i](#)

Bond lengths and bond angles in the following residue types are not validated in this section: DMU, QMU, NO3, NAG

The Z score for a bond length (or angle) is the number of standard deviations the observed value is removed from the expected value. A bond length (or angle) with $|Z| > 5$ is considered an outlier worth inspection. RMSZ is the root-mean-square of all Z scores of the bond lengths (or angles).

Mol	Chain	Bond lengths		Bond angles	
		RMSZ	# Z >5	RMSZ	# Z >5
1	A	0.26	0/2782	0.49	0/3783
1	C	0.27	0/2766	0.49	0/3761
1	D	0.28	0/2774	0.52	1/3772 (0.0%)
1	E	0.27	0/2782	0.50	0/3783
2	B	0.26	0/2813	0.48	0/3831
All	All	0.27	0/13917	0.49	1/18930 (0.0%)

There are no bond length outliers.

All (1) bond angle outliers are listed below:

Mol	Chain	Res	Type	Atoms	Z	Observed(°)	Ideal(°)
1	D	434	MET	CG-SD-CE	5.57	109.11	100.20

There are no chirality outliers.

There are no planarity outliers.

5.2 Too-close contacts [i](#)

In the following table, the Non-H and H(model) columns list the number of non-hydrogen atoms and hydrogen atoms in the chain respectively. The H(added) column lists the number of hydrogen atoms added and optimized by MolProbity. The Clashes column lists the number of clashes within the asymmetric unit, whereas Symm-Clashes lists symmetry-related clashes.

Mol	Chain	Non-H	H(model)	H(added)	Clashes	Symm-Clashes
1	A	2712	2665	2675	49	0
1	C	2696	2659	2658	36	0
1	D	2704	2670	2669	36	0
1	E	2712	2676	2675	45	0
2	B	2737	2722	2724	35	0

Continued on next page...

Continued from previous page...

Mol	Chain	Non-H	H(model)	H(added)	Clashes	Symm-Clashes
3	A	26	20	0	2	0
3	B	52	40	0	4	0
3	D	52	40	0	5	0
4	A	28	31	29	1	0
4	B	33	42	42	1	0
4	C	33	42	42	1	0
4	D	33	42	42	1	0
4	E	33	42	42	1	0
5	A	4	0	0	1	0
5	B	4	0	0	0	0
5	C	4	0	0	1	0
6	A	14	0	13	0	0
6	B	28	13	26	0	0
6	C	14	13	13	0	0
6	D	14	0	13	2	0
6	E	14	0	13	0	0
7	A	3	0	0	0	0
7	B	4	0	0	0	0
7	C	4	0	0	0	0
7	D	2	0	0	0	0
7	E	1	0	0	0	0
All	All	13961	13717	13676	190	0

The all-atom clashscore is defined as the number of clashes found per 1000 atoms (including hydrogen atoms). The all-atom clashscore for this structure is 7.

All (190) close contacts within the same asymmetric unit are listed below, sorted by their clash magnitude.

Atom-1	Atom-2	Interatomic distance (Å)	Clash overlap (Å)
1:C:259:THR:O	1:C:263:VAL:HG22	1.73	0.89
1:D:430:LYS:HG3	1:D:434:MET:CE	2.04	0.88
1:A:241:VAL:HG12	1:A:300:VAL:HG23	1.57	0.86
1:D:430:LYS:HG3	1:D:434:MET:HE2	1.58	0.85
2:B:188:VAL:HG11	2:B:206:LEU:HD21	1.60	0.82
1:E:152:ASP:OD1	1:E:224:ARG:NH1	2.20	0.74
1:D:135:ARG:NH2	1:E:105:HIS:O	2.23	0.71
1:A:310:VAL:HG22	1:A:431:ILE:HD11	1.75	0.69
1:A:273:SER:O	1:A:277:ARG:HG2	1.93	0.67
1:D:152:ASP:OD2	1:D:154:GLN:NE2	2.26	0.67
1:E:310:VAL:HG22	1:E:431:ILE:HD11	1.74	0.67
1:E:40:ARG:NH2	1:E:74:LYS:O	2.28	0.67

Continued on next page...

Continued from previous page...

Atom-1	Atom-2	Interatomic distance (Å)	Clash overlap (Å)
1:C:149:PHE:CZ	1:C:280:LEU:HD21	2.30	0.66
2:B:267:VAL:O	2:B:271:THR:HG22	1.96	0.65
1:D:251:ASN:OD1	1:E:315:LYS:NZ	2.29	0.64
2:B:188:VAL:CG1	2:B:206:LEU:HD21	2.28	0.64
1:D:40:ARG:NH2	1:D:74:LYS:O	2.31	0.64
1:E:278:ASN:HB3	4:E:501:DMU:H29	1.80	0.63
2:B:197:ARG:NH1	1:C:60:GLU:OE1	2.31	0.63
2:B:233:ILE:HG22	2:B:237:VAL:HG23	1.80	0.63
1:A:52:SER:HA	1:A:188:GLY:HA3	1.82	0.62
2:B:56:ASP:OD1	2:B:57:MET:N	2.33	0.62
1:C:135:ARG:NH2	1:D:105:HIS:O	2.33	0.61
1:E:310:VAL:HG22	1:E:431:ILE:CD1	2.31	0.60
2:B:294:THR:OG1	2:B:297:ASP:OD1	2.17	0.60
1:D:152:ASP:OD1	1:D:153:GLU:N	2.34	0.59
2:B:155:LEU:HD11	2:B:290:VAL:HG11	1.85	0.59
1:D:194:TYR:OH	1:D:224:ARG:NH2	2.35	0.59
2:B:125:THR:HG23	1:C:134:MET:SD	2.43	0.58
1:E:435:SER:HA	1:E:438:VAL:HG12	1.85	0.58
2:B:155:LEU:O	2:B:294:THR:HG22	2.02	0.58
1:A:86:ARG:HD3	1:A:123:ARG:HD3	1.85	0.58
1:E:208:THR:OG1	1:E:211:GLY:O	2.16	0.58
1:C:47:ASP:OD1	1:C:48:MET:N	2.36	0.57
1:A:306:GLU:O	1:A:310:VAL:HG23	2.05	0.56
1:A:47:ASP:OD1	1:A:48:MET:N	2.37	0.56
1:A:277:ARG:NH2	1:E:231:ILE:HB	2.20	0.56
1:A:15:ILE:HG23	2:B:42:LEU:HD23	1.88	0.56
2:B:302:VAL:HG21	2:B:453:PHE:CE1	2.40	0.56
1:C:214:THR:HG23	1:C:214:THR:O	2.06	0.55
1:A:277:ARG:NH2	1:E:232:GLN:HG2	2.21	0.55
1:D:47:ASP:OD1	1:D:48:MET:N	2.40	0.55
1:A:54:GLY:N	1:A:64:THR:O	2.40	0.55
1:E:47:ASP:OD1	1:E:48:MET:N	2.39	0.55
1:A:191:LEU:O	1:A:225:LYS:NZ	2.36	0.55
1:A:214:THR:O	1:A:214:THR:HG23	2.07	0.54
1:D:149:PHE:CZ	1:D:280:LEU:HD21	2.42	0.54
1:A:191:LEU:HD22	5:A:503:NO3:O3	2.07	0.54
1:E:214:THR:O	1:E:214:THR:HG23	2.08	0.54
1:C:116:THR:HG23	1:D:134:MET:SD	2.48	0.54
1:C:241:VAL:HG12	1:C:300:VAL:HG13	1.91	0.53
1:E:194:TYR:OH	1:E:224:ARG:NH2	2.41	0.53
1:A:277:ARG:HH22	1:E:231:ILE:HB	1.73	0.53

Continued on next page...

Continued from previous page...

Atom-1	Atom-2	Interatomic distance (Å)	Clash overlap (Å)
1:C:260:VAL:HA	1:C:263:VAL:CG2	2.39	0.53
1:A:310:VAL:HG21	1:A:432:ASP:OD1	2.09	0.52
1:D:214:THR:HG23	1:D:214:THR:O	2.09	0.52
2:B:455:LEU:C	2:B:455:LEU:HD13	2.31	0.52
1:C:146:LEU:O	1:C:287:THR:HG22	2.11	0.51
1:E:431:ILE:HA	1:E:434:MET:HG2	1.93	0.51
1:A:262:GLY:HA3	1:A:304:LEU:HD12	1.92	0.51
1:D:113:HIS:NE2	1:D:137:THR:OG1	2.36	0.51
1:E:262:GLY:HA3	1:E:304:LEU:HD12	1.92	0.51
1:C:194:TYR:OH	1:C:224:ARG:NH2	2.44	0.51
1:C:56:VAL:N	5:C:502:NO3:O2	2.38	0.51
1:D:90:ASP:OD1	1:E:165:TYR:OH	2.24	0.51
1:C:151:MET:HG3	1:C:226:ILE:HD13	1.93	0.51
6:D:504:NAG:O7	6:D:504:NAG:H3	2.11	0.50
3:A:501:QMU:O1	3:A:501:QMU:C	2.59	0.50
1:E:25:LEU:HD21	1:E:80:PHE:HB3	1.93	0.50
1:A:18:PHE:HB2	2:B:42:LEU:HD21	1.94	0.50
1:A:153:GLU:HG2	1:A:223:LYS:HB2	1.94	0.50
3:D:502:QMU:O1	3:D:502:QMU:C	2.60	0.50
1:A:267:LEU:HD11	1:E:264:THR:HG22	1.94	0.49
1:D:431:ILE:HA	1:D:434:MET:HG2	1.94	0.49
1:D:431:ILE:HA	1:D:434:MET:HE3	1.93	0.49
1:E:191:LEU:O	1:E:225:LYS:NZ	2.44	0.49
1:C:307:PHE:HA	1:C:310:VAL:HG22	1.93	0.49
1:A:241:VAL:HA	1:A:300:VAL:HG22	1.95	0.49
2:B:299:PHE:HB2	2:B:457:TYR:CE2	2.48	0.49
1:C:241:VAL:HG21	1:C:443:PHE:CZ	2.47	0.49
1:A:310:VAL:HG22	1:A:431:ILE:CD1	2.40	0.49
3:B:501:QMU:C8	3:B:501:QMU:O	2.61	0.48
2:B:157:ASN:O	2:B:160:MET:N	2.42	0.48
1:C:85:GLN:HG2	1:C:126:ASN:HD21	1.77	0.48
2:B:128:ASN:HD22	2:B:128:ASN:N	2.11	0.48
2:B:206:LEU:HD13	2:B:227:PHE:CD2	2.48	0.48
1:D:149:PHE:O	1:D:288:ALA:HB3	2.14	0.48
2:B:174:TYR:HB2	2:B:179:ILE:HD12	1.96	0.48
1:D:41:ILE:HG22	1:D:168:SER:O	2.14	0.48
2:B:68:ILE:HD12	2:B:68:ILE:N	2.29	0.48
1:D:431:ILE:O	1:D:434:MET:HG2	2.14	0.48
2:B:221:VAL:HG13	2:B:221:VAL:O	2.13	0.47
1:A:119:ASN:HD22	1:A:119:ASN:N	2.12	0.47
3:D:502:QMU:O2	3:D:502:QMU:BR	2.86	0.47

Continued on next page...

Continued from previous page...

Atom-1	Atom-2	Interatomic distance (Å)	Clash overlap (Å)
2:B:155:LEU:O	2:B:155:LEU:HD12	2.15	0.47
3:B:502:QMU:O	3:B:502:QMU:C8	2.63	0.47
1:C:135:ARG:NH1	1:D:104:PHE:O	2.47	0.47
1:D:151:MET:HG3	1:D:226:ILE:HD13	1.97	0.47
1:E:108:LYS:HE3	1:E:141:GLU:HG2	1.96	0.47
1:C:54:GLY:N	1:C:64:THR:O	2.48	0.47
1:A:431:ILE:HA	1:A:434:MET:HG2	1.97	0.47
2:B:126:THR:O	2:B:128:ASN:ND2	2.46	0.47
1:E:146:LEU:O	1:E:287:THR:HG22	2.14	0.47
3:D:501:QMU:O1	3:D:501:QMU:C3	2.63	0.46
2:B:275:THR:HG21	1:C:267:LEU:HD22	1.96	0.46
3:B:501:QMU:O1	3:B:501:QMU:C2	2.62	0.46
1:E:247:SER:OG	1:E:258:ARG:NE	2.46	0.46
1:E:442:LEU:O	1:E:445:THR:HG22	2.16	0.46
2:B:68:ILE:HD12	2:B:68:ILE:H	1.80	0.46
1:E:54:GLY:N	1:E:64:THR:O	2.49	0.46
1:A:146:LEU:O	1:A:287:THR:HG22	2.16	0.46
1:D:307:PHE:HA	1:D:310:VAL:HG22	1.97	0.46
1:E:74:LYS:NZ	1:E:76:GLU:OE2	2.49	0.45
2:B:285:ASN:HB3	4:B:503:DMU:H29	1.98	0.45
2:B:302:VAL:HG21	2:B:453:PHE:CZ	2.52	0.45
1:C:264:THR:HG22	1:D:267:LEU:HD11	1.97	0.45
1:A:146:LEU:HD12	1:A:283:VAL:HG11	1.99	0.45
1:A:277:ARG:NH1	1:E:231:ILE:HG22	2.31	0.45
1:A:435:SER:HA	1:A:438:VAL:HG12	1.98	0.45
1:C:154:GLN:O	1:C:222:LEU:N	2.48	0.45
1:E:25:LEU:HD22	1:E:78:LEU:HA	1.99	0.45
2:B:46:ILE:O	2:B:46:ILE:HG23	2.16	0.45
1:A:121:MET:SD	2:B:173:GLY:HA2	2.57	0.45
1:C:188:GLY:HA2	1:C:190:ARG:NE	2.32	0.45
1:E:149:PHE:CZ	1:E:280:LEU:HD21	2.52	0.45
1:A:149:PHE:CZ	1:A:280:LEU:HD21	2.51	0.45
1:C:262:GLY:HA3	1:C:304:LEU:HD12	1.99	0.45
1:A:150:PRO:HD3	1:A:289:MET:HB2	1.98	0.45
1:A:249:TRP:HA	1:A:436:ARG:NH2	2.32	0.45
1:E:306:GLU:O	1:E:310:VAL:HG23	2.17	0.45
1:A:164:ALA:HA	1:E:121:MET:SD	2.57	0.44
2:B:199:TYR:OH	1:C:61:MET:HG2	2.17	0.44
1:D:235:LEU:HB2	1:D:236:PRO:HD3	1.99	0.44
1:A:86:ARG:HD3	1:A:123:ARG:CG	2.48	0.44
2:B:275:THR:HG21	1:C:267:LEU:HD13	1.99	0.44

Continued on next page...

Continued from previous page...

Atom-1	Atom-2	Interatomic distance (Å)	Clash overlap (Å)
1:D:91:ASN:HB3	1:D:120:LYS:HB2	1.98	0.44
1:A:149:PHE:HB3	1:A:287:THR:HB	2.00	0.44
2:B:62:ILE:HG21	2:B:198:LEU:HD11	1.99	0.44
1:C:264:THR:CG2	1:D:267:LEU:HD11	2.47	0.44
1:D:431:ILE:HA	1:D:434:MET:SD	2.58	0.44
1:A:249:TRP:HA	1:A:436:ARG:HH21	1.81	0.44
1:E:235:LEU:HB2	1:E:236:PRO:HD3	2.00	0.44
1:E:224:ARG:HD3	1:E:229:PHE:CE2	2.53	0.43
2:B:247:THR:HG21	2:B:276:MET:HG2	1.99	0.43
1:A:25:LEU:HD21	1:A:80:PHE:HB3	2.01	0.43
1:D:247:SER:OG	1:D:258:ARG:NE	2.49	0.43
1:E:151:MET:HG3	1:E:226:ILE:HD13	2.01	0.43
1:A:249:TRP:CZ2	1:A:436:ARG:HD3	2.54	0.43
1:A:149:PHE:CD2	1:A:224:ARG:NH1	2.87	0.43
3:D:501:QMU:O2	3:D:501:QMU:BR	2.91	0.43
1:D:206:ILE:HD11	3:D:502:QMU:BR	2.74	0.42
1:A:33:LEU:HD21	1:E:22:LEU:HD11	2.02	0.42
1:C:152:ASP:OD1	1:C:224:ARG:HB2	2.20	0.42
1:C:104:PHE:CD2	1:C:160:PHE:HB3	2.55	0.42
6:D:504:NAG:O7	6:D:504:NAG:C3	2.67	0.42
1:E:72:THR:HA	1:E:130:VAL:O	2.20	0.42
1:A:235:LEU:HB2	1:A:236:PRO:HD3	2.02	0.42
1:A:266:VAL:HG12	1:A:300:VAL:HG12	2.02	0.42
2:B:269:GLY:HA3	2:B:311:LEU:HD13	2.02	0.42
1:C:121:MET:HG3	1:D:164:ALA:CB	2.50	0.42
1:D:230:VAL:HA	1:D:234:TYR:HB2	2.02	0.41
1:A:86:ARG:HD3	1:A:123:ARG:CD	2.49	0.41
3:B:502:QMU:BR	1:C:206:ILE:HD11	2.75	0.41
4:D:503:DMU:H35	4:D:503:DMU:H29	2.01	0.41
1:E:54:GLY:HA3	1:E:64:THR:HB	2.02	0.41
1:E:226:ILE:HG13	1:E:230:VAL:HG23	2.02	0.41
1:A:86:ARG:HB2	1:A:125:TRP:CZ3	2.54	0.41
1:E:238:ILE:O	1:E:241:VAL:HG22	2.20	0.41
1:C:196:LEU:HA	1:C:222:LEU:HD23	2.03	0.41
1:C:50:VAL:HG22	1:C:65:ILE:HD11	2.03	0.41
1:E:142:CYS:O	1:E:144:MET:HG3	2.19	0.41
3:A:501:QMU:O2	3:A:501:QMU:BR	2.93	0.41
4:A:502:DMU:O55	4:A:502:DMU:H36	2.21	0.41
2:B:287:LEU:HB3	2:B:288:PRO:HD2	2.03	0.41
4:C:501:DMU:H35	4:C:501:DMU:H29	2.03	0.41
1:D:40:ARG:NH1	1:D:41:ILE:O	2.54	0.41

Continued on next page...

Continued from previous page...

Atom-1	Atom-2	Interatomic distance (Å)	Clash overlap (Å)
1:D:104:PHE:HB2	1:D:107:ASP:HB2	2.02	0.41
1:A:159:LYS:HG2	1:A:217:THR:HG22	2.03	0.41
1:A:267:LEU:HD11	1:E:264:THR:CG2	2.51	0.41
1:A:436:ARG:O	1:A:440:PRO:HG2	2.20	0.41
1:C:206:ILE:HG13	1:C:206:ILE:O	2.20	0.41
1:E:136:LEU:HB3	1:E:138:ILE:HD11	2.03	0.41
1:D:431:ILE:HG12	1:D:434:MET:SD	2.61	0.40
1:A:86:ARG:HG3	1:A:125:TRP:CZ2	2.56	0.40
1:A:152:ASP:OD1	1:A:224:ARG:NH1	2.54	0.40
1:D:435:SER:HA	1:D:438:VAL:HG12	2.03	0.40
1:C:187:ASP:O	1:C:190:ARG:CZ	2.69	0.40
1:E:113:HIS:NE2	1:E:137:THR:OG1	2.44	0.40
1:C:65:ILE:HG12	1:C:67:ILE:HG23	2.04	0.40
1:E:153:GLU:HG2	1:E:223:LYS:HB2	2.04	0.40

There are no symmetry-related clashes.

5.3 Torsion angles [i](#)

5.3.1 Protein backbone [i](#)

In the following table, the Percentiles column shows the percent Ramachandran outliers of the chain as a percentile score with respect to all X-ray entries followed by that with respect to entries of similar resolution.

The Analysed column shows the number of residues for which the backbone conformation was analysed, and the total number of residues.

Mol	Chain	Analysed	Favoured	Allowed	Outliers	Percentiles	
1	A	334/350 (95%)	319 (96%)	14 (4%)	1 (0%)	41	55
1	C	332/350 (95%)	317 (96%)	14 (4%)	1 (0%)	41	55
1	D	333/350 (95%)	316 (95%)	17 (5%)	0	100	100
1	E	334/350 (95%)	319 (96%)	15 (4%)	0	100	100
2	B	333/379 (88%)	318 (96%)	14 (4%)	1 (0%)	41	55
All	All	1666/1779 (94%)	1589 (95%)	74 (4%)	3 (0%)	47	62

All (3) Ramachandran outliers are listed below:

Mol	Chain	Res	Type
1	A	83	PRO
2	B	175	PRO
1	C	83	PRO

5.3.2 Protein sidechains [i](#)

In the following table, the Percentiles column shows the percent sidechain outliers of the chain as a percentile score with respect to all X-ray entries followed by that with respect to entries of similar resolution.

The Analysed column shows the number of residues for which the sidechain conformation was analysed, and the total number of residues.

Mol	Chain	Analysed	Rotameric	Outliers	Percentiles	
1	A	298/312 (96%)	296 (99%)	2 (1%)	84	92
1	C	296/312 (95%)	295 (100%)	1 (0%)	92	97
1	D	297/312 (95%)	296 (100%)	1 (0%)	92	97
1	E	298/312 (96%)	297 (100%)	1 (0%)	92	97
2	B	302/342 (88%)	299 (99%)	3 (1%)	76	88
All	All	1491/1590 (94%)	1483 (100%)	8 (0%)	88	95

All (8) residues with a non-rotameric sidechain are listed below:

Mol	Chain	Res	Type
1	A	119	ASN
1	A	252	ARG
2	B	128	ASN
2	B	259	ARG
2	B	453	PHE
1	C	252	ARG
1	D	252	ARG
1	E	252	ARG

Sometimes sidechains can be flipped to improve hydrogen bonding and reduce clashes. All (6) such sidechains are listed below:

Mol	Chain	Res	Type
1	A	251	ASN
1	A	447	ASN
2	B	128	ASN
2	B	154	GLN

Continued on next page...

Continued from previous page...

Mol	Chain	Res	Type
1	C	126	ASN
1	E	447	ASN

5.3.3 RNA [i](#)

There are no RNA molecules in this entry.

5.4 Non-standard residues in protein, DNA, RNA chains [i](#)

There are no non-standard protein/DNA/RNA residues in this entry.

5.5 Carbohydrates [i](#)

There are no monosaccharides in this entry.

5.6 Ligand geometry [i](#)

19 ligands are modelled in this entry.

In the following table, the Counts columns list the number of bonds (or angles) for which Mogul statistics could be retrieved, the number of bonds (or angles) that are observed in the model and the number of bonds (or angles) that are defined in the Chemical Component Dictionary. The Link column lists molecule types, if any, to which the group is linked. The Z score for a bond length (or angle) is the number of standard deviations the observed value is removed from the expected value. A bond length (or angle) with $|Z| > 2$ is considered an outlier worth inspection. RMSZ is the root-mean-square of all Z scores of the bond lengths (or angles).

Mol	Type	Chain	Res	Link	Bond lengths			Bond angles		
					Counts	RMSZ	# Z > 2	Counts	RMSZ	# Z > 2
4	DMU	D	503	-	34,34,34	0.14	0	45,45,45	0.36	0
6	NAG	C	503	1	14,14,15	0.47	0	17,19,21	0.78	0
4	DMU	E	501	-	34,34,34	0.14	0	45,45,45	0.23	0
3	QMU	B	501	-	25,29,29	0.66	1 (4%)	33,45,45	0.76	1 (3%)
3	QMU	D	501	-	25,29,29	0.70	1 (4%)	33,45,45	0.68	0
6	NAG	D	504	1	14,14,15	0.46	0	17,19,21	1.07	2 (11%)
4	DMU	C	501	-	34,34,34	0.15	0	45,45,45	0.34	0
6	NAG	B	506	2	14,14,15	0.52	0	17,19,21	0.80	0
3	QMU	A	501	-	25,29,29	0.70	1 (4%)	33,45,45	0.71	1 (3%)
5	NO3	A	503	-	1,3,3	0.65	0	0,3,3	-	-
5	NO3	C	502	-	1,3,3	0.71	0	0,3,3	-	-

Mol	Type	Chain	Res	Link	Bond lengths			Bond angles		
					Counts	RMSZ	# Z > 2	Counts	RMSZ	# Z > 2
6	NAG	E	502	1	14,14,15	0.50	0	17,19,21	0.73	0
3	QMU	B	502	-	25,29,29	0.89	2 (8%)	33,45,45	0.78	1 (3%)
6	NAG	B	505	2	14,14,15	0.48	0	17,19,21	0.91	1 (5%)
5	NO3	B	504	-	1,3,3	0.71	0	0,3,3	-	-
3	QMU	D	502	-	25,29,29	0.70	1 (4%)	33,45,45	0.73	1 (3%)
4	DMU	B	503	-	34,34,34	0.14	0	45,45,45	0.27	0
6	NAG	A	504	1	14,14,15	0.51	0	17,19,21	0.74	0
4	DMU	A	502	-	29,29,34	0.15	0	40,40,45	0.31	0

In the following table, the Chirals column lists the number of chiral outliers, the number of chiral centers analysed, the number of these observed in the model and the number defined in the Chemical Component Dictionary. Similar counts are reported in the Torsion and Rings columns. '-' means no outliers of that kind were identified.

Mol	Type	Chain	Res	Link	Chirals	Torsions	Rings
6	NAG	A	504	1	-	0/6/23/26	0/1/1/1
3	QMU	B	501	-	-	3/9/35/35	0/3/4/4
4	DMU	D	503	-	-	8/19/59/59	0/2/2/2
6	NAG	D	504	1	-	1/6/23/26	0/1/1/1
3	QMU	D	501	-	-	4/9/35/35	0/3/4/4
3	QMU	B	502	-	-	0/9/35/35	0/3/4/4
6	NAG	B	505	2	-	0/6/23/26	0/1/1/1
4	DMU	C	501	-	-	2/19/59/59	0/2/2/2
6	NAG	B	506	2	-	0/6/23/26	0/1/1/1
6	NAG	C	503	1	-	3/6/23/26	0/1/1/1
3	QMU	D	502	-	-	5/9/35/35	0/3/4/4
4	DMU	E	501	-	-	6/19/59/59	0/2/2/2
6	NAG	E	502	1	-	0/6/23/26	0/1/1/1
4	DMU	B	503	-	-	6/19/59/59	0/2/2/2
3	QMU	A	501	-	-	5/9/35/35	0/3/4/4
4	DMU	A	502	-	-	5/14/54/59	0/2/2/2

All (6) bond length outliers are listed below:

Mol	Chain	Res	Type	Atoms	Z	Observed(Å)	Ideal(Å)
3	B	502	QMU	C6-N1	2.96	1.41	1.36
3	B	502	QMU	C14-N2	-2.36	1.31	1.35
3	B	501	QMU	C14-N2	-2.22	1.31	1.35
3	D	502	QMU	C14-N2	-2.17	1.31	1.35

Continued on next page...

Continued from previous page...

Mol	Chain	Res	Type	Atoms	Z	Observed(Å)	Ideal(Å)
3	D	501	QMU	C14-N2	-2.14	1.31	1.35
3	A	501	QMU	C14-N2	-2.14	1.31	1.35

All (7) bond angle outliers are listed below:

Mol	Chain	Res	Type	Atoms	Z	Observed(°)	Ideal(°)
3	B	502	QMU	C15-C13-C12	-3.41	120.24	122.21
3	B	501	QMU	C4-C5-N2	-2.51	115.69	120.42
6	D	504	NAG	C1-O5-C5	2.32	115.33	112.19
6	D	504	NAG	C2-N2-C7	2.27	126.14	122.90
6	B	505	NAG	C1-O5-C5	2.21	115.18	112.19
3	A	501	QMU	C15-C13-C12	-2.08	121.01	122.21
3	D	502	QMU	C15-C13-C12	-2.06	121.02	122.21

There are no chirality outliers.

All (48) torsion outliers are listed below:

Mol	Chain	Res	Type	Atoms
6	D	504	NAG	C3-C2-N2-C7
3	A	501	QMU	C-C1-O-C4
3	D	502	QMU	C-C1-O-C4
3	A	501	QMU	C3-C1-O-C4
3	D	502	QMU	C2-C1-O-C4
3	A	501	QMU	C2-C1-O-C4
3	D	502	QMU	C3-C1-O-C4
3	D	501	QMU	C3-C1-O-C4
3	D	501	QMU	C2-C1-O-C4
3	D	501	QMU	C-C1-O-C4
3	B	501	QMU	C2-C1-O-C4
3	B	501	QMU	C3-C1-O-C4
3	B	501	QMU	C-C1-O-C4
4	E	501	DMU	O6-C11-C9-O1
6	C	503	NAG	O5-C5-C6-O6
6	C	503	NAG	C1-C2-N2-C7
6	C	503	NAG	C4-C5-C6-O6
4	E	501	DMU	O6-C11-C9-C8
4	B	503	DMU	O6-C11-C9-O1
4	E	501	DMU	C31-C34-C37-C40
4	E	501	DMU	C18-C19-C22-C25
4	B	503	DMU	O6-C11-C9-C8
4	B	503	DMU	C18-C19-C22-C25
4	A	502	DMU	O5-C4-C57-O61

Continued on next page...

Continued from previous page...

Mol	Chain	Res	Type	Atoms
4	D	503	DMU	C25-C28-C31-C34
4	D	503	DMU	C31-C34-C37-C40
4	E	501	DMU	C19-C22-C25-C28
4	A	502	DMU	C4-C3-O7-C10
4	A	502	DMU	O6-C11-C9-C8
3	A	501	QMU	O-C4-C5-C6
3	D	501	QMU	O-C4-C5-C6
3	D	502	QMU	O-C4-C5-C6
4	A	502	DMU	C2-C3-O7-C10
4	D	503	DMU	C4-C3-O7-C10
4	D	503	DMU	C2-C3-O7-C10
4	C	501	DMU	C4-C3-O7-C10
4	C	501	DMU	C2-C3-O7-C10
4	D	503	DMU	C19-C22-C25-C28
4	B	503	DMU	C4-C3-O7-C10
4	B	503	DMU	C19-C22-C25-C28
4	E	501	DMU	O5-C6-O16-C18
4	B	503	DMU	C2-C3-O7-C10
4	A	502	DMU	O6-C11-C9-O1
3	A	501	QMU	O-C4-C5-N2
3	D	502	QMU	O-C4-C5-N2
4	D	503	DMU	O6-C11-C9-C8
4	D	503	DMU	O6-C11-C9-O1
4	D	503	DMU	C28-C31-C34-C37

There are no ring outliers.

13 monomers are involved in 20 short contacts:

Mol	Chain	Res	Type	Clashes	Symm-Clashes
4	D	503	DMU	1	0
4	E	501	DMU	1	0
3	B	501	QMU	2	0
3	D	501	QMU	2	0
6	D	504	NAG	2	0
4	C	501	DMU	1	0
3	A	501	QMU	2	0
5	A	503	NO3	1	0
5	C	502	NO3	1	0
3	B	502	QMU	2	0
3	D	502	QMU	3	0
4	B	503	DMU	1	0
4	A	502	DMU	1	0

The following is a two-dimensional graphical depiction of Mogul quality analysis of bond lengths, bond angles, torsion angles, and ring geometry for all instances of the Ligand of Interest. In addition, ligands with molecular weight > 250 and outliers as shown on the validation Tables will also be included. For torsion angles, if less than 5% of the Mogul distribution of torsion angles is within 10 degrees of the torsion angle in question, then that torsion angle is considered an outlier. Any bond that is central to one or more torsion angles identified as an outlier by Mogul will be highlighted in the graph. For rings, the root-mean-square deviation (RMSD) between the ring in question and similar rings identified by Mogul is calculated over all ring torsion angles. If the average RMSD is greater than 60 degrees and the minimal RMSD between the ring in question and any Mogul-identified rings is also greater than 60 degrees, then that ring is considered an outlier. The outliers are highlighted in purple. The color gray indicates Mogul did not find sufficient equivalents in the CSD to analyse the geometry.

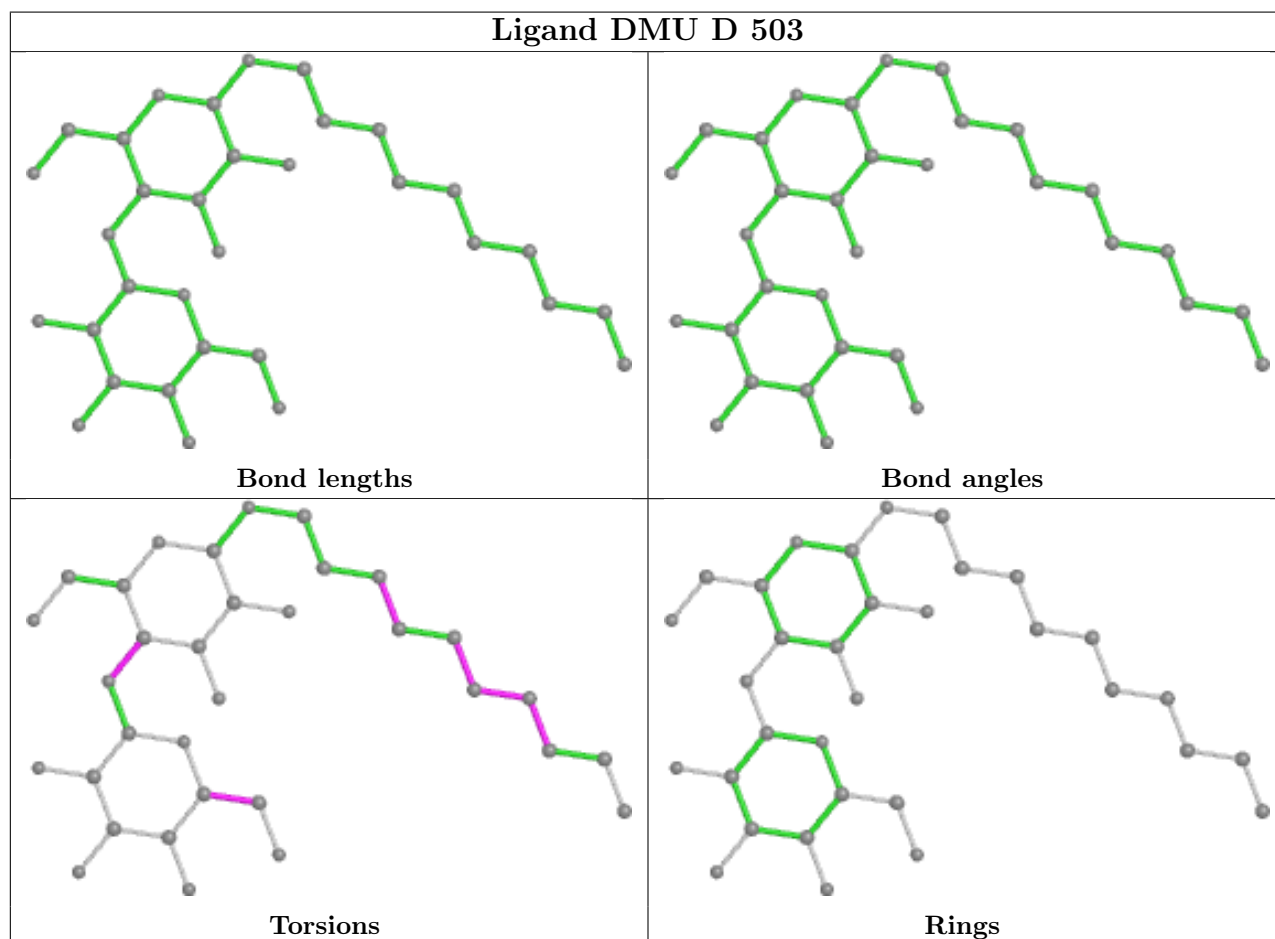

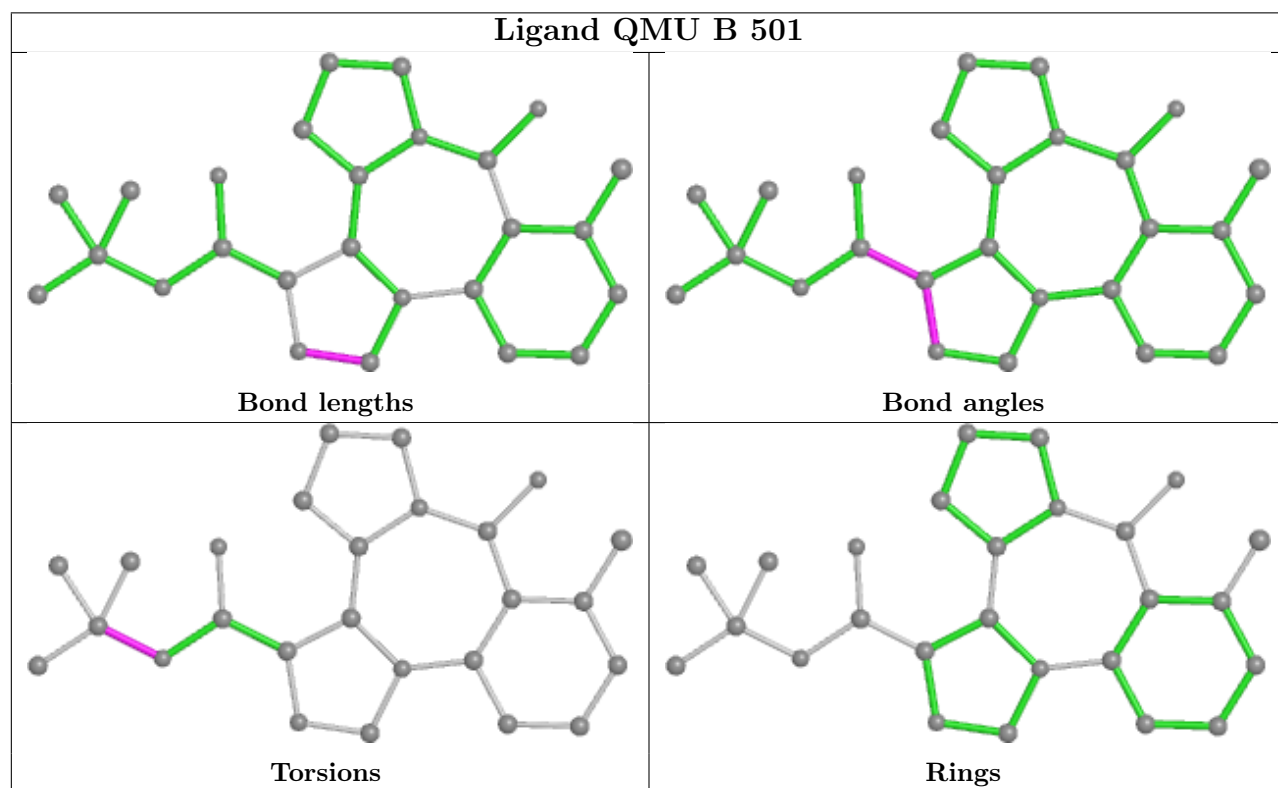
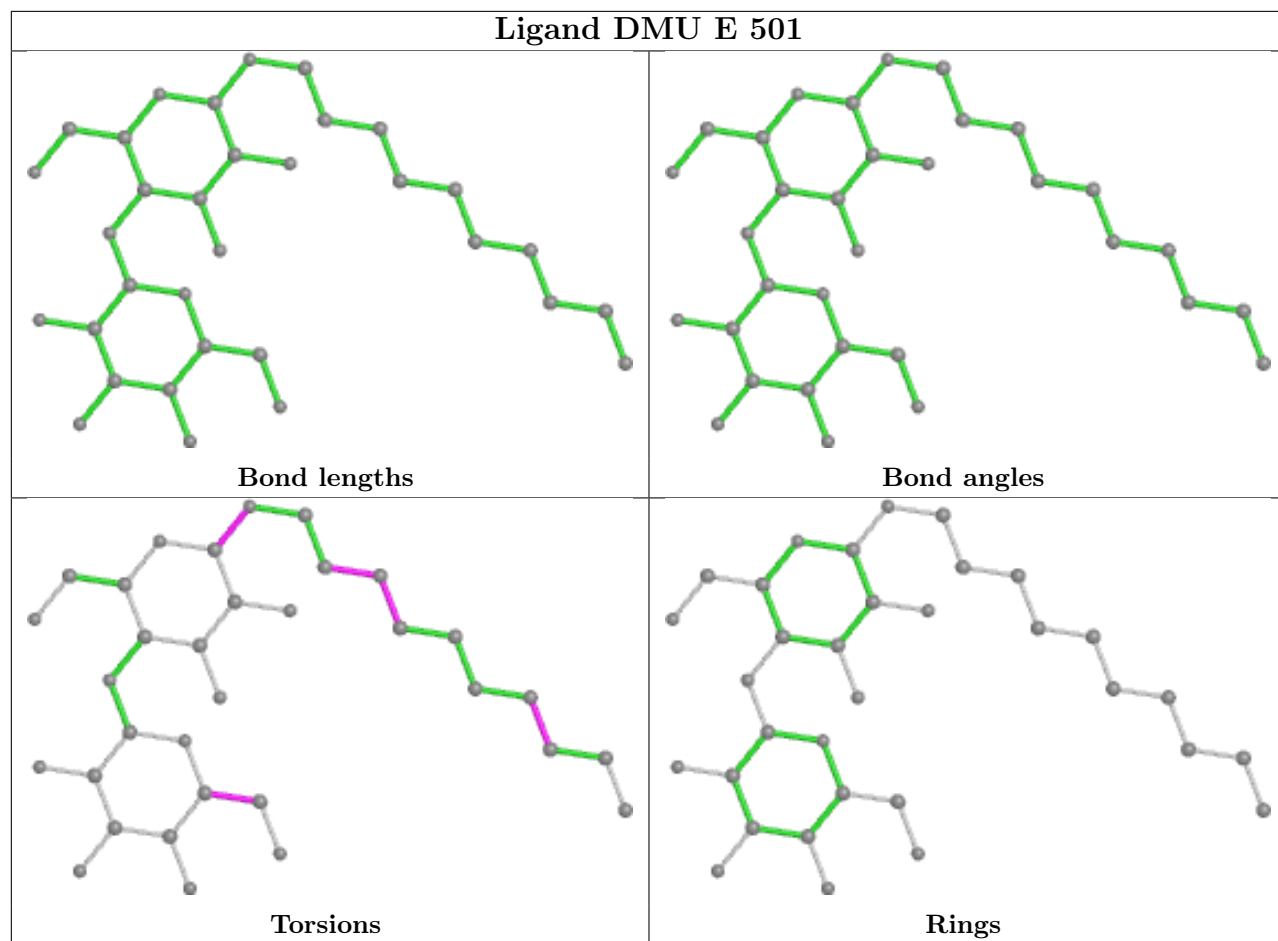

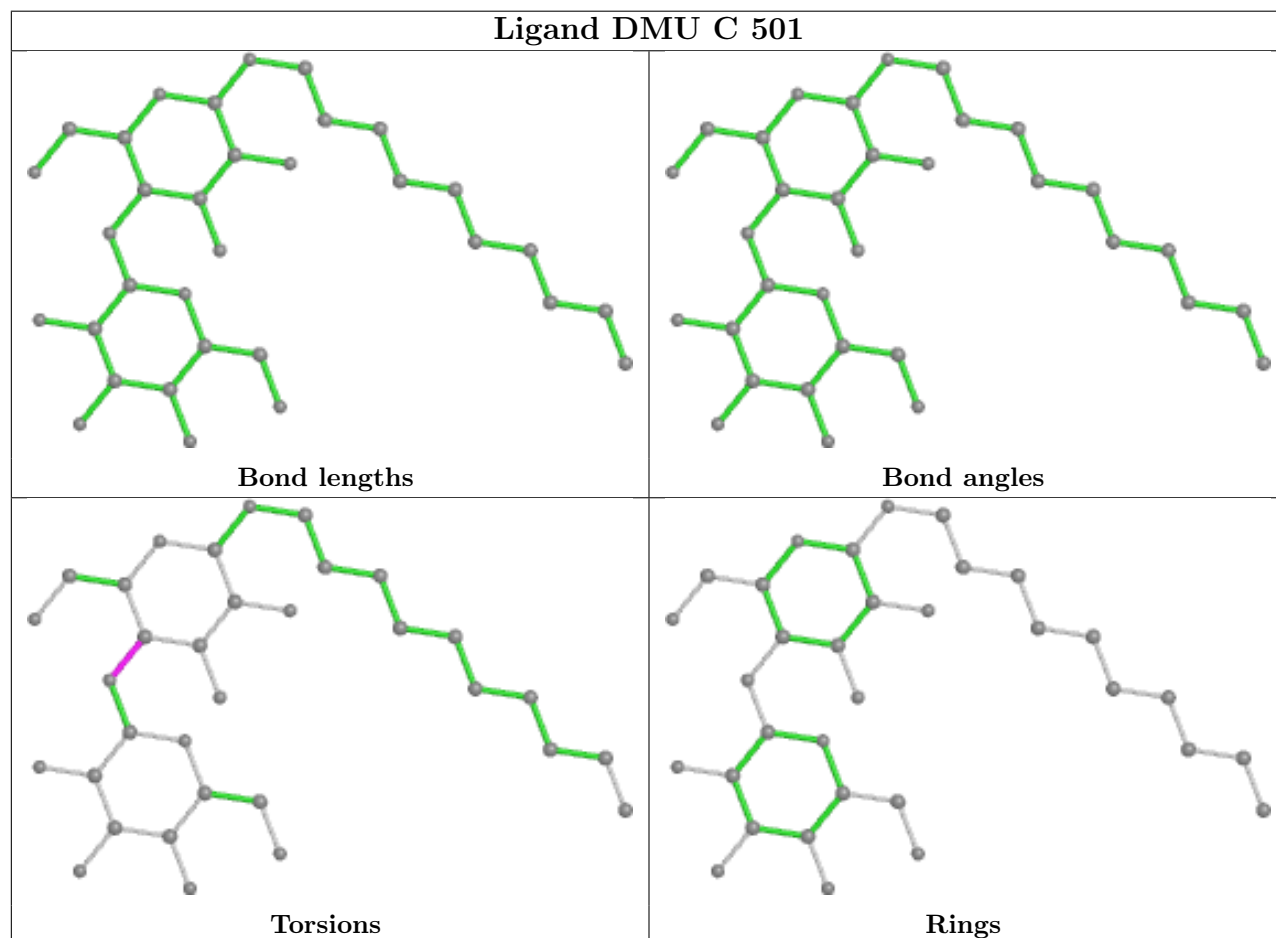
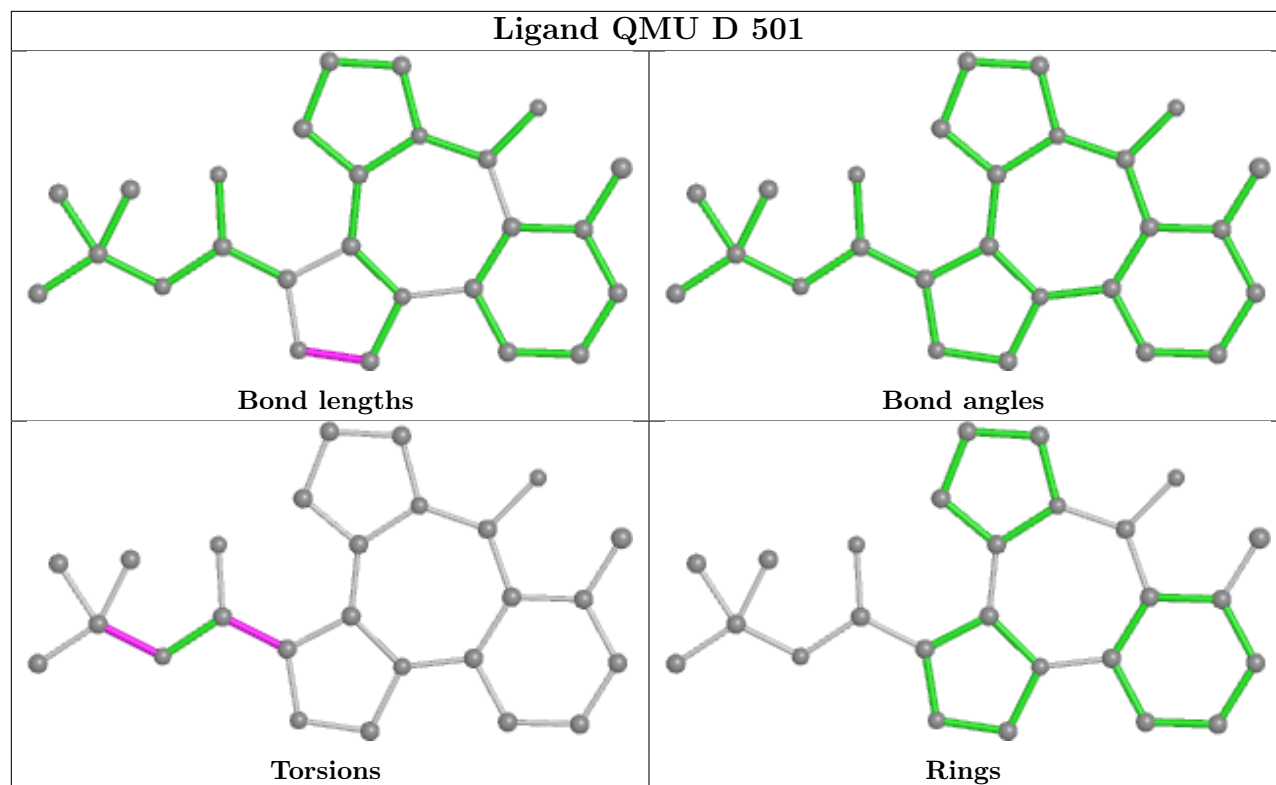

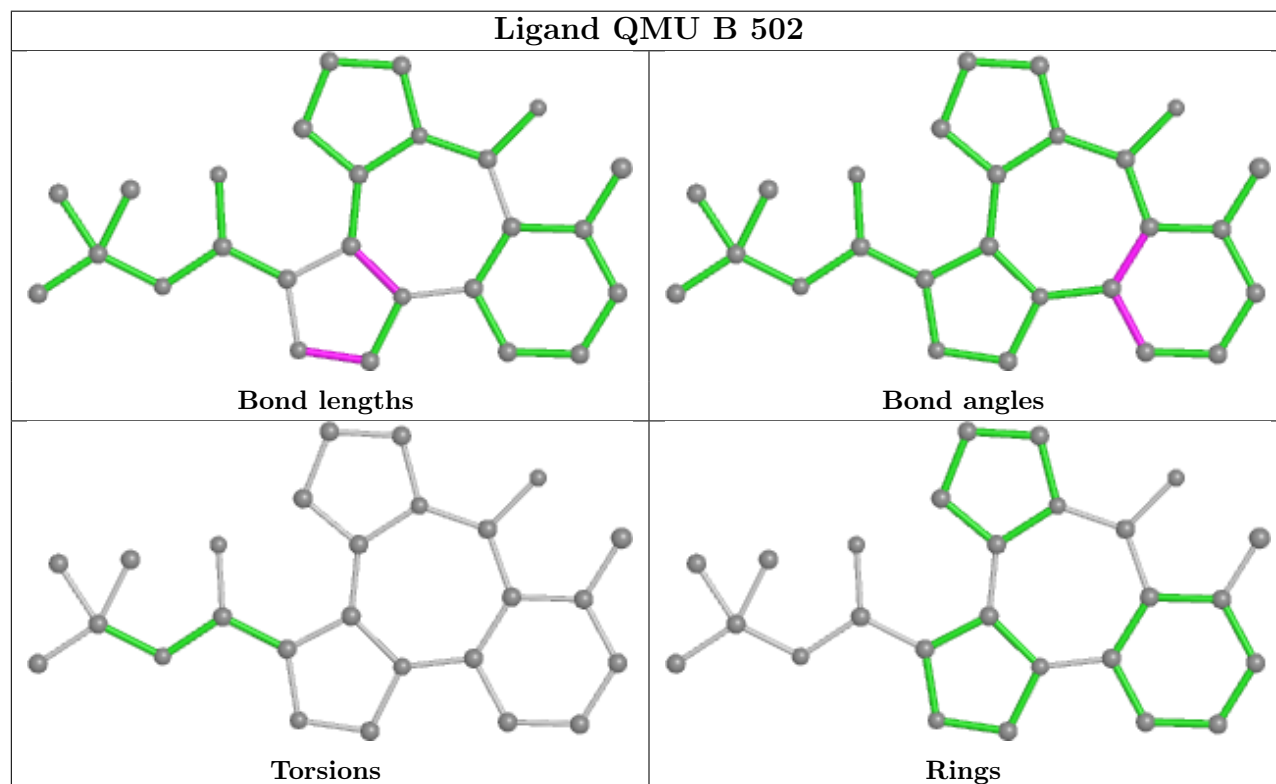
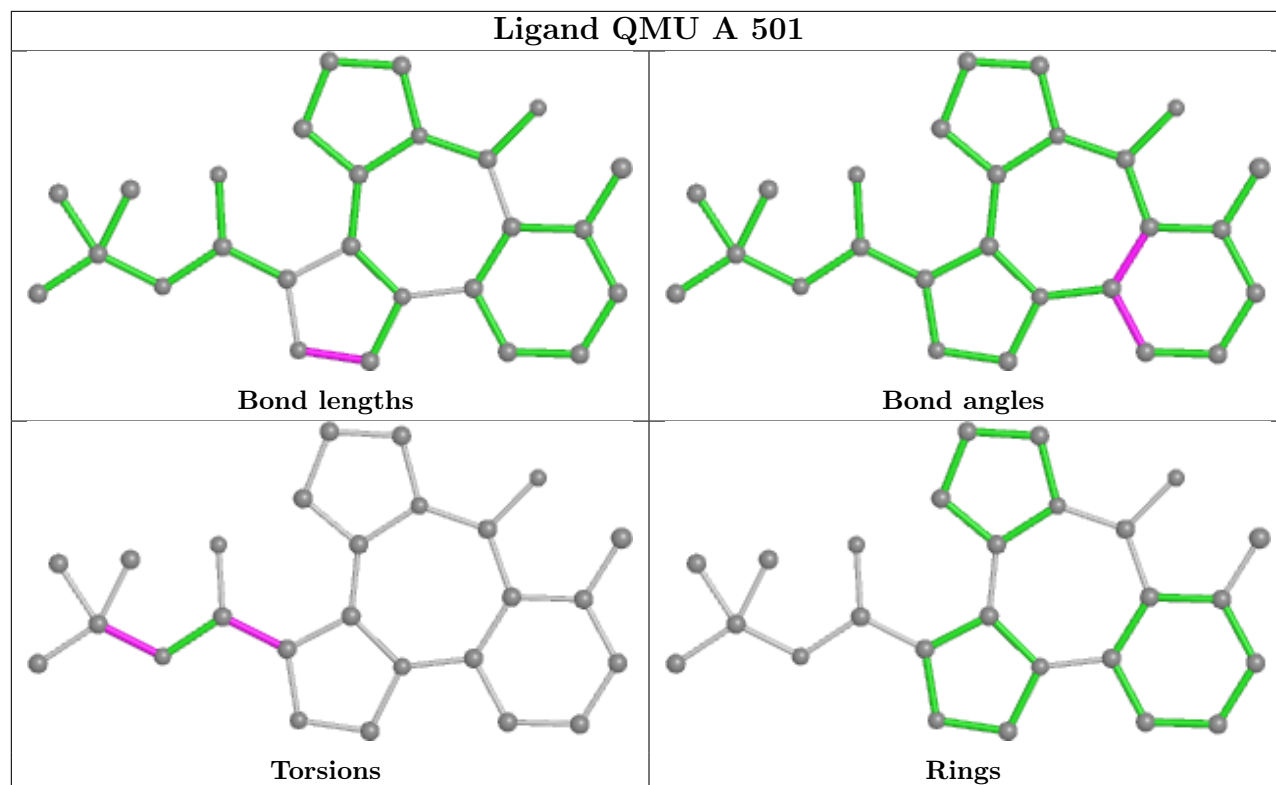

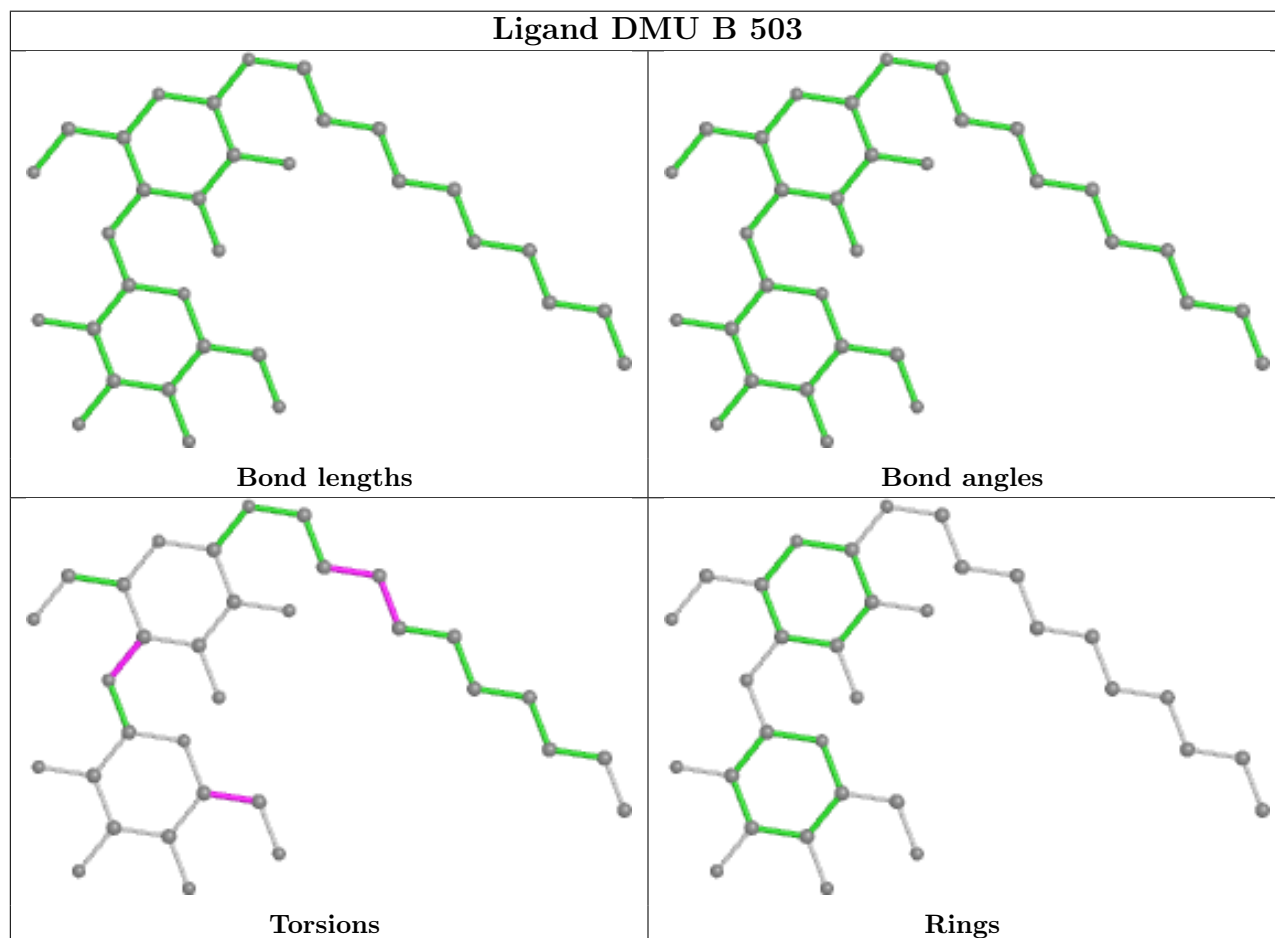
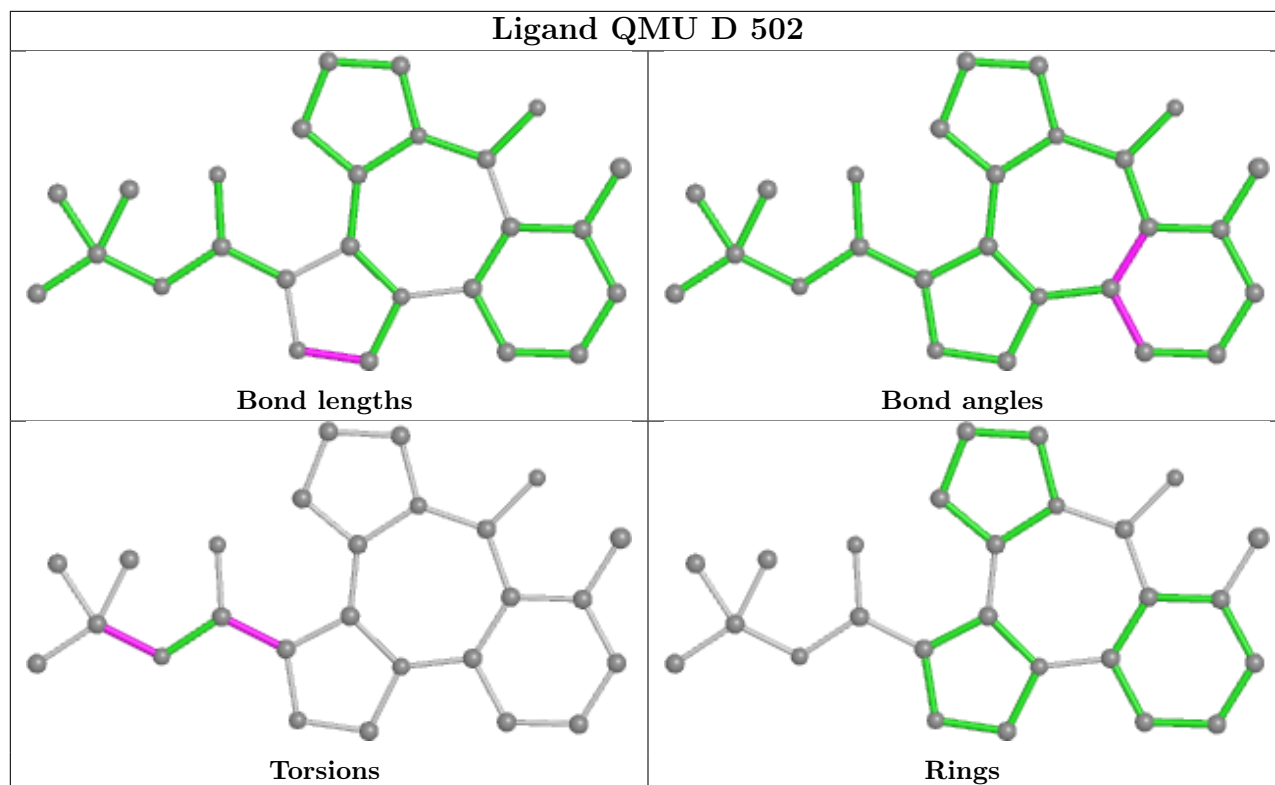

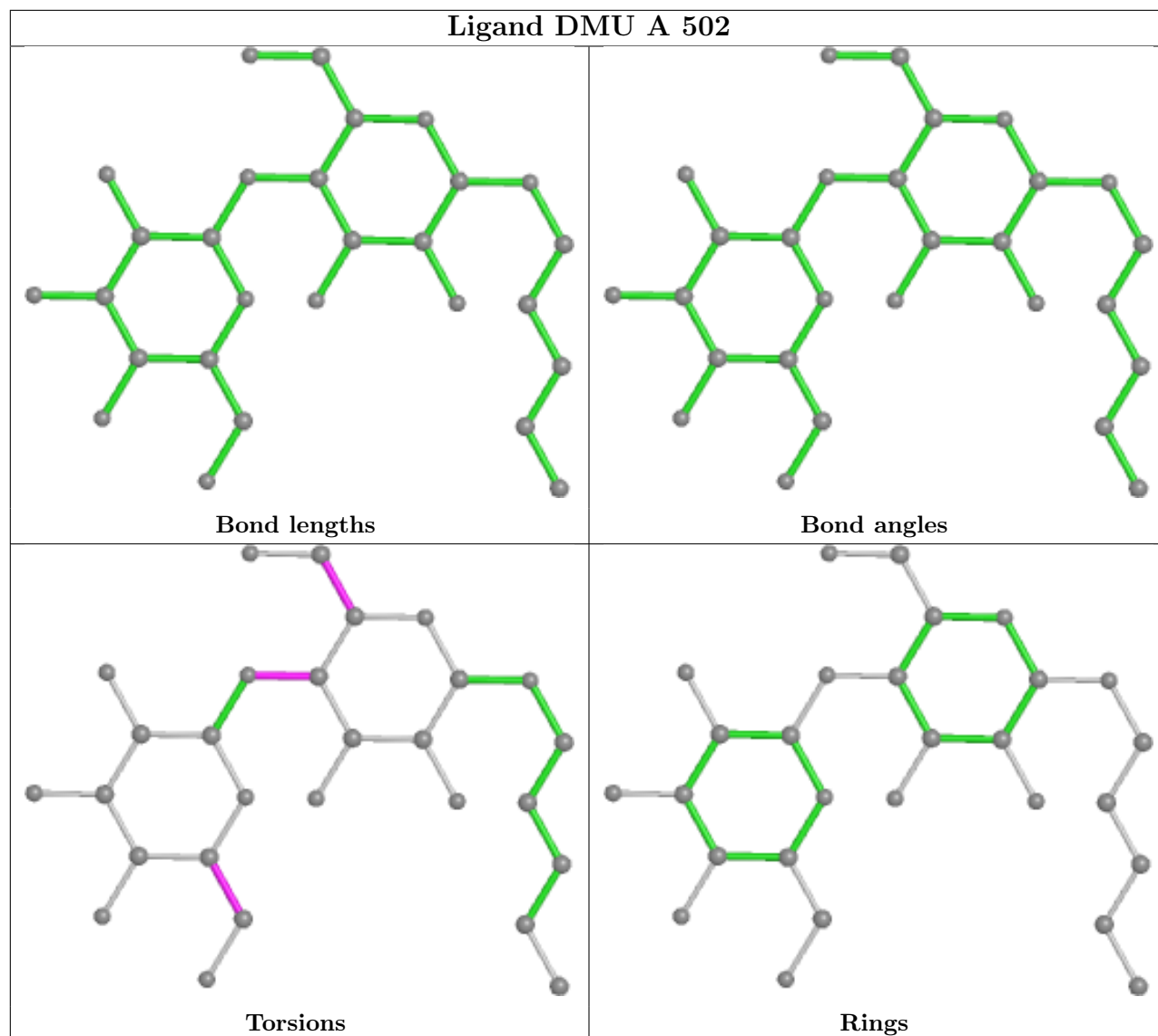

5.7 Other polymers [i](#)

There are no such residues in this entry.

5.8 Polymer linkage issues [i](#)

There are no chain breaks in this entry.

6 Fit of model and data

6.1 Protein, DNA and RNA chains

In the following table, the column labelled ‘#RSRZ > 2’ contains the number (and percentage) of RSRZ outliers, followed by percent RSRZ outliers for the chain as percentile scores relative to all X-ray entries and entries of similar resolution. The OWAB column contains the minimum, median, 95th percentile and maximum values of the occupancy-weighted average B-factor per residue. The column labelled ‘Q < 0.9’ lists the number of (and percentage) of residues with an average occupancy less than 0.9.

Mol	Chain	Analysed	<RSRZ>	#RSRZ>2	OWAB(Å ²)	Q<0.9
1	A	336/350 (96%)	1.62	100 (29%) 0 0	42, 64, 96, 114	0
1	C	334/350 (95%)	0.91	48 (14%) 2 2	17, 37, 67, 120	0
1	D	335/350 (95%)	1.27	68 (20%) 1 0	24, 50, 87, 113	0
1	E	336/350 (96%)	1.76	116 (34%) 0 0	48, 69, 99, 126	0
2	B	334/379 (88%)	1.15	60 (17%) 1 1	35, 59, 89, 107	0
All	All	1675/1779 (94%)	1.34	392 (23%) 0 0	17, 58, 92, 126	0

All (392) RSRZ outliers are listed below:

Mol	Chain	Res	Type	RSRZ
1	D	84	MET	17.1
1	D	15	ILE	12.4
1	D	16	THR	11.8
1	D	87	LEU	11.7
2	B	330	LYS	11.1
1	D	17	ILE	10.9
1	E	437	ILE	10.6
1	E	14	ASN	10.0
2	B	441	LEU	9.6
1	E	319	ALA	8.7
1	D	18	PHE	8.7
2	B	327	ARG	8.5
1	D	85	GLN	8.5
1	A	430	LYS	8.4
1	A	434	MET	8.2
1	D	189	SER	8.1
1	E	249	TRP	7.8
1	A	200	THR	7.8
1	E	18	PHE	7.8
1	A	87	LEU	7.8

Continued on next page...

Continued from previous page...

Mol	Chain	Res	Type	RSRZ
1	D	125	TRP	7.7
2	B	438	ILE	7.7
1	C	22	LEU	7.4
1	E	321	ALA	7.3
1	D	20	ARG	7.2
1	A	84	MET	7.1
1	E	124	ILE	7.1
1	D	81	LYS	7.0
1	E	20	ARG	7.0
1	C	178	SER	6.7
1	A	230	VAL	6.6
1	C	179	THR	6.6
1	E	452	ALA	6.5
1	D	80	PHE	6.4
2	B	440	ARG	6.4
1	E	230	VAL	6.4
1	E	125	TRP	6.2
1	A	18	PHE	6.2
1	E	81	LYS	6.2
2	B	324	GLN	6.2
1	A	313	ILE	6.2
1	A	309	PHE	6.1
1	E	448	LEU	6.1
1	A	33	LEU	6.0
1	A	202	GLY	5.9
1	E	17	ILE	5.9
2	B	323	SER	5.8
2	B	23	PRO	5.7
2	B	326	ALA	5.7
1	C	87	LEU	5.7
1	E	38	GLY	5.6
1	E	112	ALA	5.5
1	A	83	PRO	5.4
2	B	328	ALA	5.4
1	D	218	ALA	5.4
1	E	217	THR	5.3
1	A	319	ALA	5.2
1	D	79	ARG	5.2
1	E	111	PHE	5.2
1	E	128	GLY	5.1
1	C	24	GLY	5.1
1	C	309	PHE	5.1

Continued on next page...

Continued from previous page...

Mol	Chain	Res	Type	RSRZ
1	D	83	PRO	5.0
1	A	197	MET	4.9
1	A	176	ASN	4.9
1	A	315	LYS	4.8
1	A	448	LEU	4.8
1	E	16	THR	4.8
1	C	263	VAL	4.8
1	A	451	TRP	4.7
1	C	316	SER	4.7
1	A	265	THR	4.6
1	C	21	ILE	4.6
1	C	18	PHE	4.6
1	D	186	GLU	4.6
1	E	79	ARG	4.6
2	B	320	PHE	4.6
1	A	320	ARG	4.5
1	C	177	GLY	4.5
1	A	196	LEU	4.5
1	E	15	ILE	4.5
1	A	266	VAL	4.4
1	E	21	ILE	4.4
1	E	317	GLN	4.4
1	E	129	ARG	4.4
1	E	316	SER	4.4
1	A	260	VAL	4.3
2	B	329	ALA	4.3
2	B	444	ILE	4.3
1	E	454	TYR	4.3
1	E	216	MET	4.3
1	A	85	GLN	4.2
1	E	433	LYS	4.2
1	E	273	SER	4.2
1	A	20	ARG	4.2
1	D	179	THR	4.1
1	E	87	LEU	4.1
2	B	154	GLN	4.1
1	D	220	PHE	4.1
1	A	218	ALA	4.1
1	A	291	TRP	4.1
2	B	298	TRP	4.1
1	C	78	LEU	4.1
1	E	80	PHE	4.1

Continued on next page...

Continued from previous page...

Mol	Chain	Res	Type	RSRZ
1	E	275	SER	4.1
1	E	451	TRP	4.1
1	A	455	LEU	4.0
1	D	195	HIS	4.0
1	E	456	ASN	4.0
1	A	177	GLY	4.0
1	A	195	HIS	4.0
1	E	318	PRO	4.0
1	E	40	ARG	4.0
2	B	322	LYS	4.0
1	E	313	ILE	3.9
1	A	317	GLN	3.9
1	A	445	THR	3.9
2	B	202	SER	3.9
1	D	249	TRP	3.8
1	A	178	SER	3.8
1	D	200	THR	3.8
1	E	138	ILE	3.8
1	A	25	LEU	3.8
1	E	22	LEU	3.7
1	A	80	PHE	3.7
1	A	277	ARG	3.7
1	A	454	TYR	3.7
1	C	264	THR	3.7
1	E	167	ASN	3.7
1	E	453	THR	3.7
1	C	89	LEU	3.7
1	D	22	LEU	3.7
1	D	291	TRP	3.7
1	A	234	TYR	3.7
1	E	181	SER	3.7
1	A	321	ALA	3.7
1	C	20	ARG	3.7
1	E	455	LEU	3.7
1	A	198	GLY	3.7
1	C	201	VAL	3.7
2	B	93	ILE	3.7
1	C	291	TRP	3.6
2	B	214	LYS	3.6
2	B	229	LEU	3.6
1	E	271	THR	3.6
2	B	203	PHE	3.6

Continued on next page...

Continued from previous page...

Mol	Chain	Res	Type	RSRZ
1	C	25	LEU	3.6
1	E	266	VAL	3.6
2	B	96	LEU	3.6
1	A	17	ILE	3.5
1	A	264	THR	3.5
1	A	431	ILE	3.5
1	A	272	LEU	3.5
1	E	264	THR	3.5
1	E	65	ILE	3.5
1	E	83	PRO	3.5
2	B	133	ILE	3.5
1	E	268	THR	3.5
2	B	48	VAL	3.5
1	A	229	PHE	3.4
1	A	271	THR	3.4
1	E	24	GLY	3.4
1	D	138	ILE	3.4
1	E	265	THR	3.4
1	E	260	VAL	3.4
2	B	316	THR	3.4
2	B	95	VAL	3.4
2	B	35	LEU	3.4
1	D	183	VAL	3.3
1	E	263	VAL	3.3
1	A	27	ASP	3.3
1	E	267	LEU	3.3
1	A	267	LEU	3.3
1	E	89	LEU	3.3
1	A	437	ILE	3.3
1	E	200	THR	3.3
1	A	450	TYR	3.3
1	D	449	VAL	3.3
1	C	26	LEU	3.3
1	A	158	LEU	3.3
1	D	53	PHE	3.2
2	B	456	VAL	3.2
1	E	276	ALA	3.2
1	E	226	ILE	3.2
1	A	21	ILE	3.2
1	A	274	ILE	3.2
2	B	272	THR	3.2
1	E	37	LEU	3.2

Continued on next page...

Continued from previous page...

Mol	Chain	Res	Type	RSRZ
1	A	441	ILE	3.2
1	E	320	ARG	3.2
1	E	118	PRO	3.2
2	B	293	ALA	3.2
1	E	272	LEU	3.2
1	C	14	ASN	3.1
1	A	261	PHE	3.1
1	E	305	LEU	3.1
2	B	275	THR	3.1
1	D	126	ASN	3.1
1	E	231	ILE	3.1
1	A	276	ALA	3.1
2	B	188	VAL	3.0
1	C	15	ILE	3.0
1	D	184	VAL	3.0
1	E	151	MET	3.0
1	D	437	ILE	3.0
1	C	80	PHE	3.0
1	A	81	LYS	3.0
1	D	251	ASN	3.0
1	E	39	GLU	3.0
1	A	259	THR	3.0
1	D	190	ARG	3.0
1	E	122	LEU	2.9
1	D	188	GLY	2.9
1	A	316	SER	2.9
1	E	198	GLY	2.9
1	D	124	ILE	2.9
2	B	233	ILE	2.9
1	D	86	ARG	2.9
1	E	253	GLU	2.9
1	D	129	ARG	2.9
1	A	201	VAL	2.9
1	C	260	VAL	2.9
1	A	186	GLU	2.9
1	A	237	CYS	2.9
1	C	200	THR	2.9
2	B	230	SER	2.9
1	E	191	LEU	2.9
1	A	262	GLY	2.9
1	D	255	VAL	2.9
1	C	27	ASP	2.9

Continued on next page...

Continued from previous page...

Mol	Chain	Res	Type	RSRZ
2	B	92	THR	2.8
1	E	262	GLY	2.8
2	B	149	ALA	2.8
2	B	195	SER	2.8
1	A	278	ASN	2.8
1	E	308	ALA	2.8
1	A	240	THR	2.8
1	E	274	ILE	2.8
1	A	263	VAL	2.8
1	D	456	ASN	2.8
2	B	325	PRO	2.8
1	D	136	LEU	2.8
1	E	450	TYR	2.8
1	C	182	VAL	2.7
1	C	286	ALA	2.7
2	B	261	SER	2.7
1	A	216	MET	2.7
1	D	271	THR	2.7
2	B	263	ALA	2.7
1	E	441	ILE	2.7
1	E	270	THR	2.7
1	E	183	VAL	2.7
1	E	110	SER	2.7
1	A	226	ILE	2.7
1	D	185	ALA	2.7
1	E	27	ASP	2.7
2	B	46	ILE	2.6
1	A	82	GLY	2.6
1	D	78	LEU	2.6
1	E	315	LYS	2.6
1	E	238	ILE	2.6
1	A	268	THR	2.6
1	C	271	THR	2.6
1	D	264	THR	2.6
1	A	449	VAL	2.6
1	E	78	LEU	2.6
2	B	33	ASN	2.6
1	C	275	SER	2.6
1	A	79	ARG	2.6
2	B	194	ARG	2.6
1	A	286	ALA	2.6
1	E	186	GLU	2.6

Continued on next page...

Continued from previous page...

Mol	Chain	Res	Type	RSRZ
2	B	274	LEU	2.6
1	D	434	MET	2.6
1	A	217	THR	2.5
1	E	434	MET	2.5
1	D	180	LYS	2.5
1	E	41	ILE	2.5
1	A	249	TRP	2.5
1	A	300	VAL	2.5
1	E	126	ASN	2.5
1	E	310	VAL	2.5
1	A	284	ALA	2.5
1	C	276	ALA	2.5
1	A	92	ARG	2.5
1	E	250	LEU	2.5
1	E	115	MET	2.5
2	B	267	VAL	2.5
1	D	430	LYS	2.5
1	C	281	PRO	2.5
1	C	262	GLY	2.5
1	C	265	THR	2.4
1	D	94	ALA	2.4
1	E	113	HIS	2.4
1	D	243	LEU	2.4
1	D	48	MET	2.4
1	E	218	ALA	2.4
1	E	309	PHE	2.4
1	A	293	ILE	2.4
1	A	275	SER	2.4
1	A	433	LYS	2.4
1	D	265	THR	2.4
1	E	69	PHE	2.4
1	E	215	ILE	2.4
1	E	312	TYR	2.4
2	B	312	ILE	2.4
1	C	147	GLU	2.4
1	A	219	HIS	2.4
1	C	237	CYS	2.4
1	C	249	TRP	2.4
1	A	257	ALA	2.4
1	C	268	THR	2.4
1	C	230	VAL	2.4
1	E	54	GLY	2.3

Continued on next page...

Continued from previous page...

Mol	Chain	Res	Type	RSRZ
1	A	150	PRO	2.3
1	C	267	LEU	2.3
2	B	268	PHE	2.3
1	A	269	MET	2.3
1	E	179	THR	2.3
1	E	201	VAL	2.3
2	B	85	ARG	2.3
2	B	259	ARG	2.3
1	A	285	TYR	2.3
1	E	269	MET	2.3
1	D	221	HIS	2.3
1	A	40	ARG	2.3
2	B	138	ARG	2.3
2	B	278	THR	2.3
1	D	204	GLU	2.3
1	D	309	PHE	2.3
1	D	268	THR	2.2
1	E	225	LYS	2.2
1	A	453	THR	2.2
1	C	33	LEU	2.2
1	A	90	ASP	2.2
1	D	269	MET	2.2
1	E	197	MET	2.2
2	B	262	VAL	2.2
1	E	114	GLY	2.2
1	E	242	ILE	2.2
1	A	243	LEU	2.2
1	E	153	GLU	2.2
1	E	159	LYS	2.2
1	D	242	ILE	2.2
1	E	240	THR	2.2
1	A	222	LEU	2.2
1	E	261	PHE	2.2
1	A	296	CYS	2.2
1	D	196	LEU	2.2
1	D	155	ASN	2.1
1	E	180	LYS	2.1
1	E	213	TYR	2.1
1	E	449	VAL	2.1
1	C	259	THR	2.1
1	A	89	LEU	2.1
1	A	280	LEU	2.1

Continued on next page...

Continued from previous page...

Mol	Chain	Res	Type	RSRZ
1	A	244	SER	2.1
1	E	209	SER	2.1
2	B	24[A]	GLU	2.1
1	E	257	ALA	2.1
2	B	189	GLU	2.1
1	D	65	ILE	2.1
1	D	267	LEU	2.1
1	D	187	ASP	2.1
1	A	140	ALA	2.1
1	A	253	GLU	2.1
1	C	54	GLY	2.1
1	C	23	ASP	2.1
1	A	270	THR	2.1
2	B	271	THR	2.1
2	B	283	ALA	2.1
2	B	213	VAL	2.1
1	D	226	ILE	2.1
1	D	69	PHE	2.1
2	B	319	TYR	2.1
1	D	147	GLU	2.0
1	E	136	LEU	2.0
1	C	279	SER	2.0
1	D	54	GLY	2.0
1	A	199	GLN	2.0
1	D	263	VAL	2.0
1	C	124	ILE	2.0
2	B	449	LEU	2.0
1	C	254	SER	2.0
1	D	303	ALA	2.0
1	C	95	ASP	2.0
1	C	261	PHE	2.0
1	E	174	TRP	2.0
1	E	33	LEU	2.0
1	A	24	GLY	2.0
1	D	203	THR	2.0
2	B	445	ALA	2.0

6.2 Non-standard residues in protein, DNA, RNA chains

There are no non-standard protein/DNA/RNA residues in this entry.

6.3 Carbohydrates [i](#)

There are no monosaccharides in this entry.

6.4 Ligands [i](#)

In the following table, the Atoms column lists the number of modelled atoms in the group and the number defined in the chemical component dictionary. The B-factors column lists the minimum, median, 95th percentile and maximum values of B factors of atoms in the group. The column labelled 'Q< 0.9' lists the number of atoms with occupancy less than 0.9.

Mol	Type	Chain	Res	Atoms	RSCC	RSR	B-factors(Å ²)	Q<0.9
6	NAG	B	505	14/15	0.55	0.24	78,94,114,116	0
6	NAG	A	504	14/15	0.75	0.62	75,79,86,91	0
6	NAG	B	506	14/15	0.77	0.19	72,84,94,95	0
6	NAG	E	502	14/15	0.81	0.28	94,104,107,110	0
6	NAG	D	504	14/15	0.83	0.27	62,74,80,81	0
3	QMU	D	501	26/26	0.86	0.19	56,71,89,150	0
3	QMU	A	501	26/26	0.87	0.21	45,59,82,100	0
5	NO3	B	504	4/4	0.88	0.14	36,41,41,42	0
3	QMU	B	502	26/26	0.89	0.21	38,50,72,110	0
3	QMU	B	501	26/26	0.89	0.17	52,63,76,126	0
5	NO3	A	503	4/4	0.89	0.16	58,61,62,63	0
6	NAG	C	503	14/15	0.90	0.17	48,57,70,73	0
3	QMU	D	502	26/26	0.92	0.19	23,31,37,100	0
4	DMU	E	501	33/33	0.92	0.23	24,42,55,73	0
5	NO3	C	502	4/4	0.92	0.21	30,33,34,36	0
4	DMU	A	502	28/33	0.93	0.25	32,43,53,66	0
4	DMU	D	503	33/33	0.93	0.19	22,30,39,43	0
4	DMU	C	501	33/33	0.94	0.20	16,30,36,39	0
4	DMU	B	503	33/33	0.95	0.17	29,42,57,62	0

The following is a graphical depiction of the model fit to experimental electron density of all instances of the Ligand of Interest. In addition, ligands with molecular weight > 250 and outliers as shown on the geometry validation Tables will also be included. Each fit is shown from different orientation to approximate a three-dimensional view.

Electron density around QMU D 501:

$2mF_o-DF_c$ (at 0.7 rmsd) in gray
 mF_o-DF_c (at 3 rmsd) in purple (negative)
and green (positive)

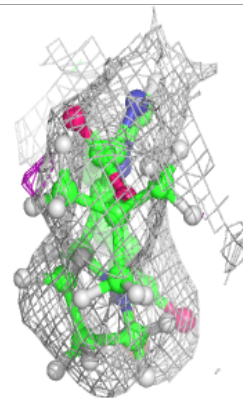
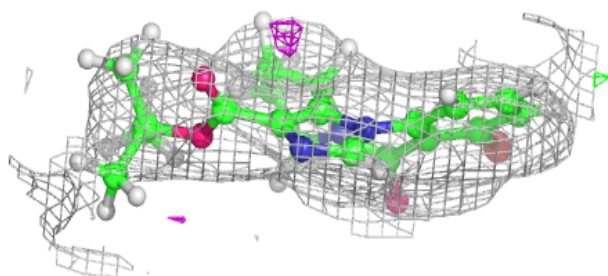
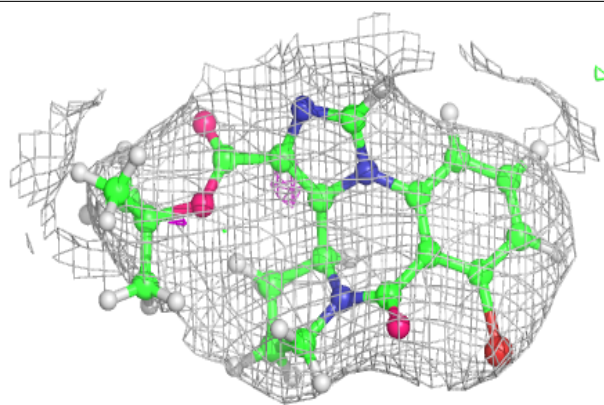
**Electron density around QMU A 501:**

$2mF_o-DF_c$ (at 0.7 rmsd) in gray
 mF_o-DF_c (at 3 rmsd) in purple (negative)
and green (positive)

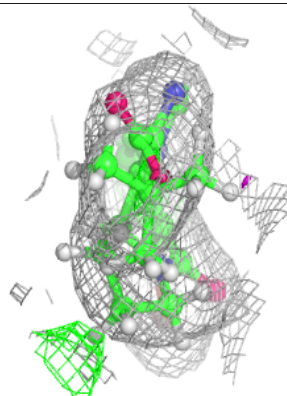
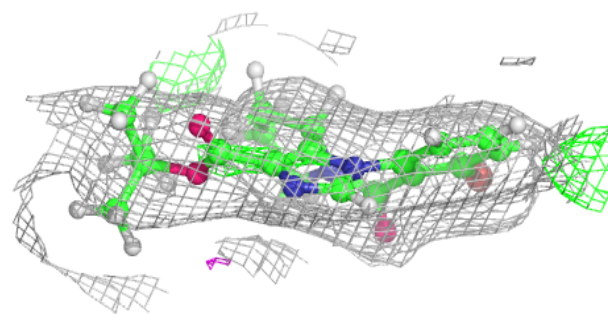
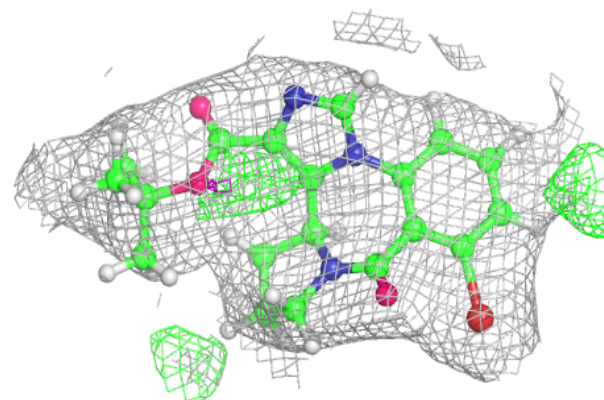

Electron density around QMU B 502:

$2mF_o-DF_c$ (at 0.7 rmsd) in gray
 mF_o-DF_c (at 3 rmsd) in purple (negative)
and green (positive)

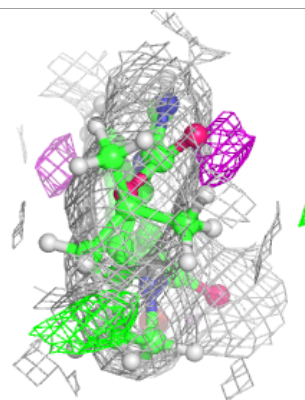
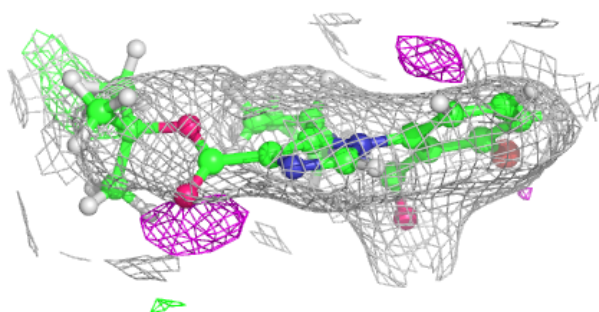
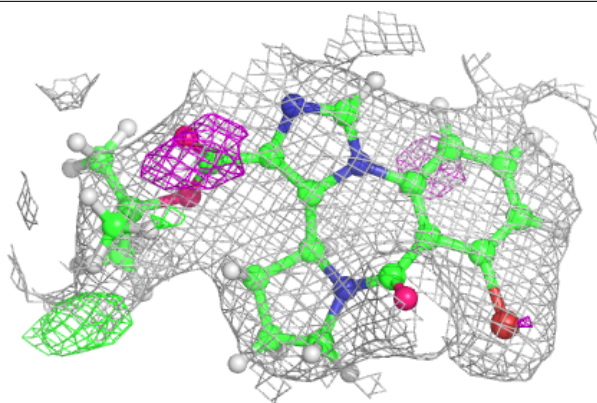
**Electron density around QMU B 501:**

$2mF_o-DF_c$ (at 0.7 rmsd) in gray
 mF_o-DF_c (at 3 rmsd) in purple (negative)
and green (positive)

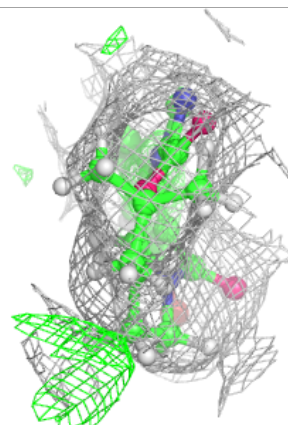
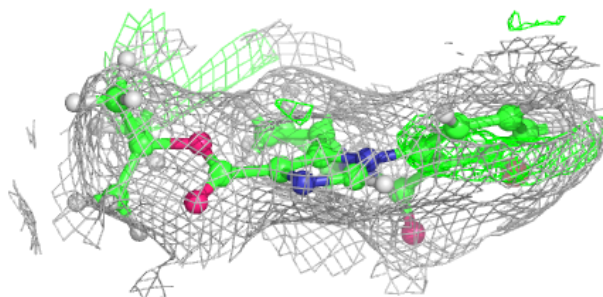
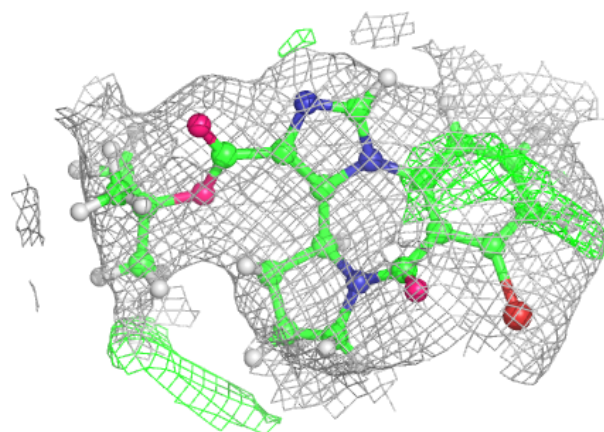

Electron density around QMU D 502:

$2mF_o-DF_c$ (at 0.7 rmsd) in gray
 mF_o-DF_c (at 3 rmsd) in purple (negative)
and green (positive)

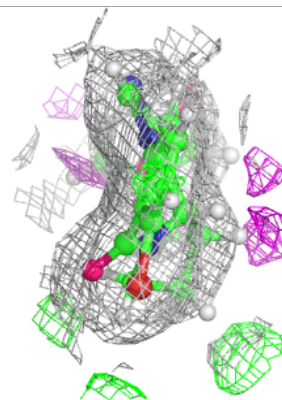
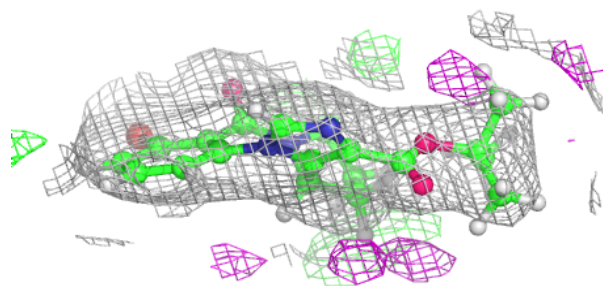
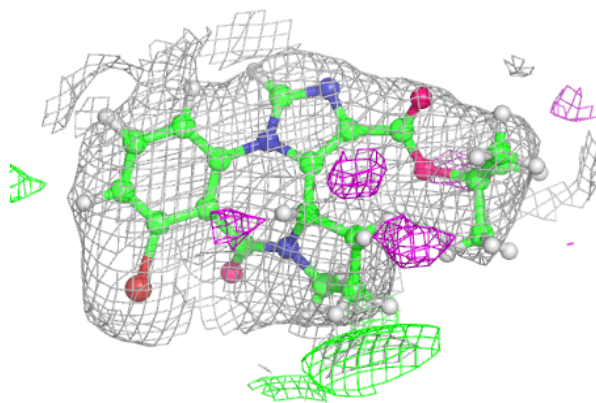
**Electron density around DMU E 501:**

$2mF_o-DF_c$ (at 0.7 rmsd) in gray
 mF_o-DF_c (at 3 rmsd) in purple (negative)
and green (positive)

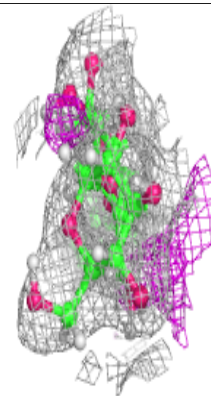
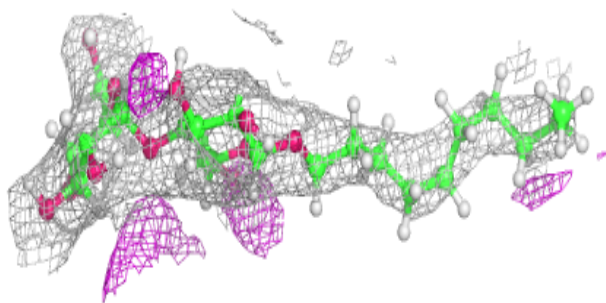
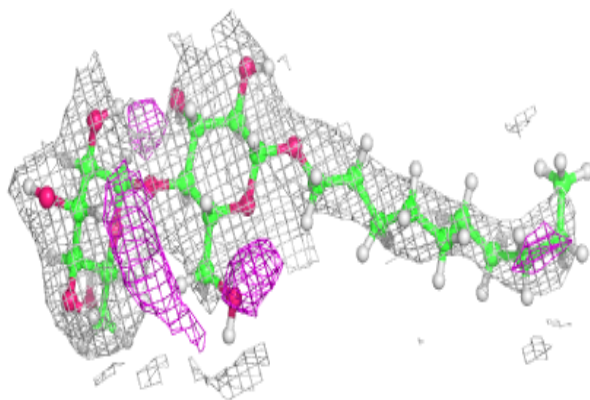

Electron density around DMU A 502:

$2mF_o-DF_c$ (at 0.7 rmsd) in gray
 mF_o-DF_c (at 3 rmsd) in purple (negative)
and green (positive)

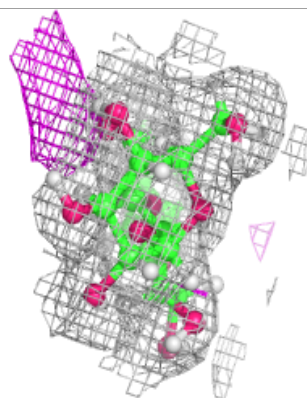
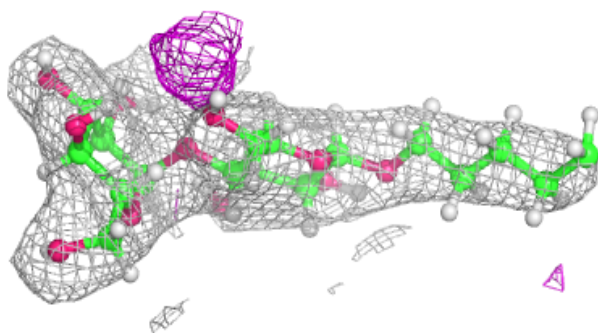
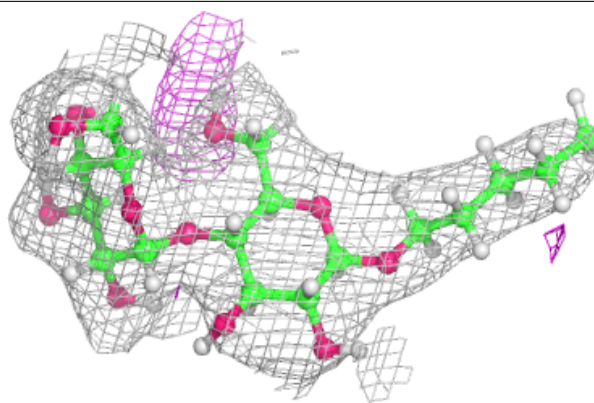
**Electron density around DMU D 503:**

$2mF_o-DF_c$ (at 0.7 rmsd) in gray
 mF_o-DF_c (at 3 rmsd) in purple (negative)
and green (positive)

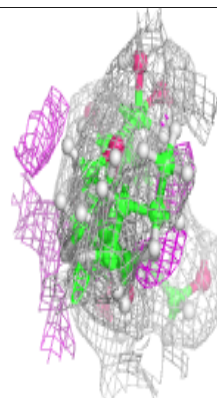
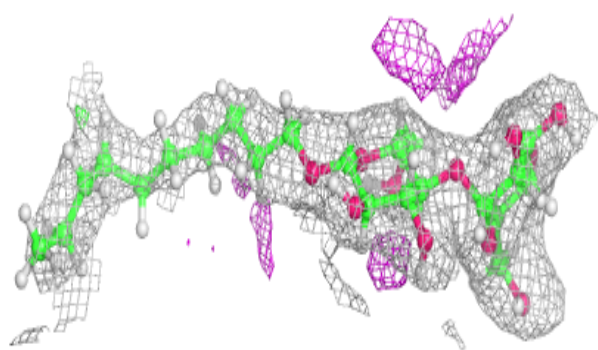
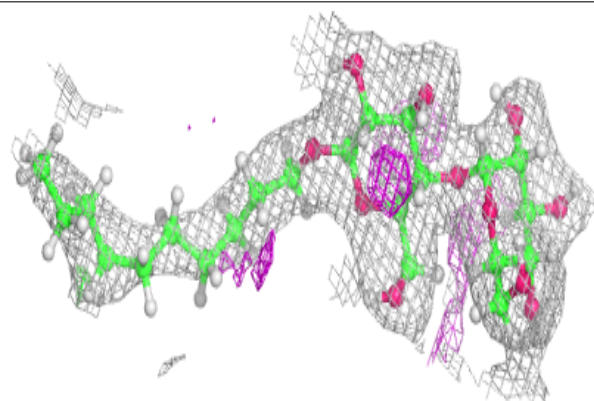

Electron density around DMU C 501:

$2mF_o-DF_c$ (at 0.7 rmsd) in gray
 mF_o-DF_c (at 3 rmsd) in purple (negative)
and green (positive)

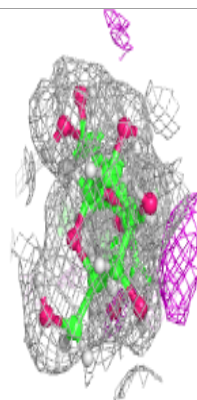
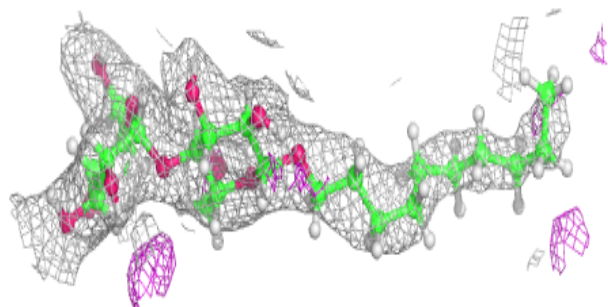
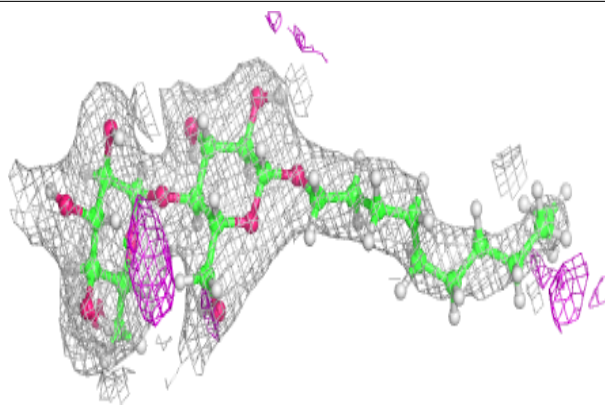
**Electron density around DMU B 503:**

$2mF_o-DF_c$ (at 0.7 rmsd) in gray
 mF_o-DF_c (at 3 rmsd) in purple (negative)
and green (positive)

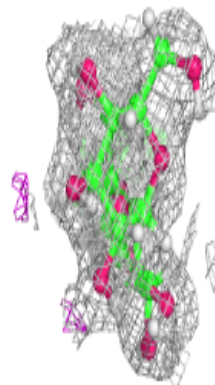
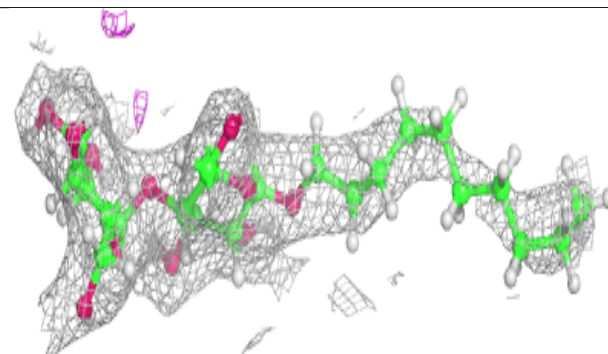
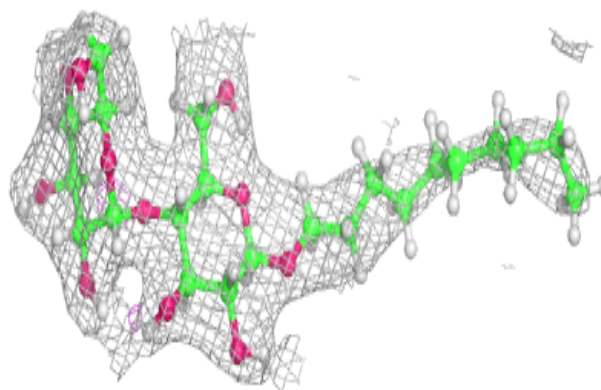

6.5 Other polymers [i](#)

There are no such residues in this entry.