



Full wwPDB EM Validation Report ⓘ

Oct 13, 2024 – 08:10 PM EDT

PDB ID : 7MW5
EMDB ID : EMD-24063
Title : Structure of the SARS-CoV-2 Spike trimer with one RBD down in complex with the Fab fragment of human neutralizing antibody clone 2
Authors : Hu, Y.; Xiong, Y.
Deposited on : 2021-05-15
Resolution : 3.42 Å(reported)

This is a Full wwPDB EM Validation Report for a publicly released PDB entry.

We welcome your comments at validation@mail.wwpdb.org

A user guide is available at

<https://www.wwpdb.org/validation/2017/EMValidationReportHelp>

with specific help available everywhere you see the ⓘ symbol.

The types of validation reports are described at

<http://www.wwpdb.org/validation/2017/FAQs#types>.

The following versions of software and data (see [references ⓘ](#)) were used in the production of this report:

EMDB validation analysis : 0.0.1.dev113
Mogul : 2022.3.0, CSD as543be (2022)
MolProbity : 4.02b-467
buster-report : 1.1.7 (2018)
Percentile statistics : 20231227.v01 (using entries in the PDB archive December 27th 2023)
MapQ : 1.9.13
Ideal geometry (proteins) : Engh & Huber (2001)
Ideal geometry (DNA, RNA) : Parkinson et al. (1996)
Validation Pipeline (wwPDB-VP) : 2.39

1 Overall quality at a glance i

The following experimental techniques were used to determine the structure:

ELECTRON MICROSCOPY

The reported resolution of this entry is 3.42 Å.

Percentile scores (ranging between 0-100) for global validation metrics of the entry are shown in the following graphic. The table shows the number of entries on which the scores are based.

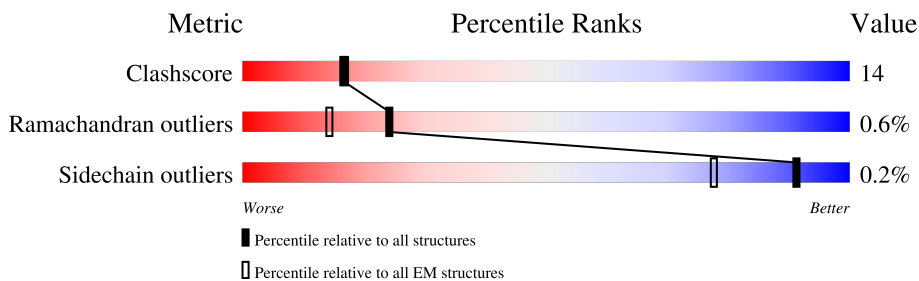













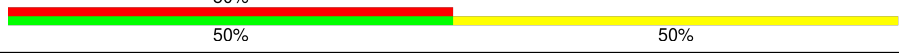

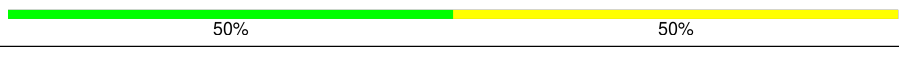
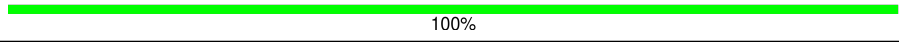

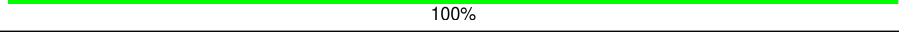
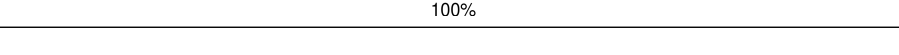
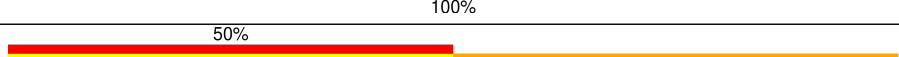

Metric	Whole archive (#Entries)	EM structures (#Entries)
Clashscore	210492	15764
Ramachandran outliers	207382	16835
Sidechain outliers	206894	16415

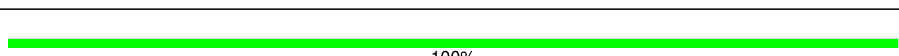
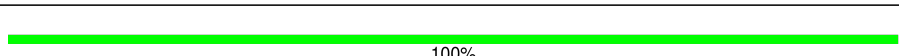
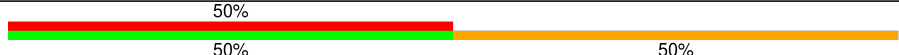
The table below summarises the geometric issues observed across the polymeric chains and their fit to the map. The red, orange, yellow and green segments of the bar indicate the fraction of residues that contain outliers for ≥ 3 , 2, 1 and 0 types of geometric quality criteria respectively. A grey segment represents the fraction of residues that are not modelled. The numeric value for each fraction is indicated below the corresponding segment, with a dot representing fractions $\leq 5\%$. The upper red bar (where present) indicates the fraction of residues that have poor fit to the EM map (all-atom inclusion $< 40\%$). The numeric value is given above the bar.

Mol	Chain	Length	Quality of chain
1	E	265	
1	G	265	
1	L	265	
2	D	263	
2	F	263	
2	H	263	
3	A	1288	
3	B	1288	

Continued on next page...

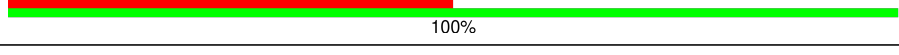
Continued from previous page...

Mol	Chain	Length	Quality of chain
3	C	1288	
4	I	2	
4	J	2	
4	K	2	
4	M	2	
4	N	2	
4	O	2	
4	P	2	
4	Q	2	
4	R	2	
4	S	2	
4	T	2	
4	U	2	
4	V	2	
4	W	2	
4	X	2	
4	Y	2	
4	Z	2	
4	a	2	
4	b	2	
4	c	2	
4	d	2	
4	e	2	
4	f	2	
4	g	2	

Continued on next page...

Continued from previous page...

Mol	Chain	Length	Quality of chain
4	h	2	 100%
4	i	2	 100%
4	j	2	 50% 100%
4	k	2	 50% 100%
4	l	2	 100%

2 Entry composition i

There are 5 unique types of molecules in this entry. The entry contains 33635 atoms, of which 0 are hydrogens and 0 are deuteriums.

In the tables below, the AltConf column contains the number of residues with at least one atom in alternate conformation and the Trace column contains the number of residues modelled with at most 2 atoms.

- Molecule 1 is a protein called Fab of antibody clone 2, light chain.

Mol	Chain	Residues	Atoms					AltConf	Trace
			Total	C	N	O	S		
1	L	215	Total 1640	C 1029	N 279	O 326	S 6	0	0
1	G	215	Total 1640	C 1029	N 279	O 326	S 6	0	0
1	E	110	Total 829	C 524	N 141	O 160	S 4	0	0

- Molecule 2 is a protein called Fab of antibody clone 2, heavy chain.

Mol	Chain	Residues	Atoms					AltConf	Trace
			Total	C	N	O	S		
2	H	209	Total 1541	C 969	N 254	O 311	S 7	0	0
2	F	209	Total 1541	C 969	N 254	O 311	S 7	0	0
2	D	113	Total 843	C 525	N 140	O 173	S 5	0	0

- Molecule 3 is a protein called Spike glycoprotein.

Mol	Chain	Residues	Atoms					AltConf	Trace
			Total	C	N	O	S		
3	C	1057	Total 8149	C 5218	N 1359	O 1534	S 38	1	0
3	B	1057	Total 8145	C 5215	N 1357	O 1535	S 38	1	0
3	A	1057	Total 8145	C 5215	N 1357	O 1535	S 38	1	0

There are 255 discrepancies between the modelled and reference sequences:

Chain	Residue	Modelled	Actual	Comment	Reference
C	682	GLY	ARG	conflict	UNP P0DTC2
C	683	SER	ARG	conflict	UNP P0DTC2
C	685	SER	ARG	conflict	UNP P0DTC2

Continued on next page...

Continued from previous page...

Chain	Residue	Modelled	Actual	Comment	Reference
C	986	PRO	LYS	conflict	UNP P0DTC2
C	987	PRO	VAL	conflict	UNP P0DTC2
C	1209	GLY	-	expression tag	UNP P0DTC2
C	1210	SER	-	expression tag	UNP P0DTC2
C	1211	GLY	-	expression tag	UNP P0DTC2
C	1212	TYR	-	expression tag	UNP P0DTC2
C	1213	ILE	-	expression tag	UNP P0DTC2
C	1214	PRO	-	expression tag	UNP P0DTC2
C	1215	GLU	-	expression tag	UNP P0DTC2
C	1216	ALA	-	expression tag	UNP P0DTC2
C	1217	PRO	-	expression tag	UNP P0DTC2
C	1218	ARG	-	expression tag	UNP P0DTC2
C	1219	ASP	-	expression tag	UNP P0DTC2
C	1220	GLY	-	expression tag	UNP P0DTC2
C	1221	GLN	-	expression tag	UNP P0DTC2
C	1222	ALA	-	expression tag	UNP P0DTC2
C	1223	TYR	-	expression tag	UNP P0DTC2
C	1224	VAL	-	expression tag	UNP P0DTC2
C	1225	ARG	-	expression tag	UNP P0DTC2
C	1226	LYS	-	expression tag	UNP P0DTC2
C	1227	ASP	-	expression tag	UNP P0DTC2
C	1228	GLY	-	expression tag	UNP P0DTC2
C	1229	GLU	-	expression tag	UNP P0DTC2
C	1230	TRP	-	expression tag	UNP P0DTC2
C	1231	VAL	-	expression tag	UNP P0DTC2
C	1232	LEU	-	expression tag	UNP P0DTC2
C	1233	LEU	-	expression tag	UNP P0DTC2
C	1234	SER	-	expression tag	UNP P0DTC2
C	1235	THR	-	expression tag	UNP P0DTC2
C	1236	PHE	-	expression tag	UNP P0DTC2
C	1237	LEU	-	expression tag	UNP P0DTC2
C	1238	GLY	-	expression tag	UNP P0DTC2
C	1239	ARG	-	expression tag	UNP P0DTC2
C	1240	SER	-	expression tag	UNP P0DTC2
C	1241	LEU	-	expression tag	UNP P0DTC2
C	1242	GLU	-	expression tag	UNP P0DTC2
C	1243	VAL	-	expression tag	UNP P0DTC2
C	1244	LEU	-	expression tag	UNP P0DTC2
C	1245	PHE	-	expression tag	UNP P0DTC2
C	1246	GLN	-	expression tag	UNP P0DTC2
C	1247	GLY	-	expression tag	UNP P0DTC2
C	1248	PRO	-	expression tag	UNP P0DTC2

Continued on next page...

Continued from previous page...

Chain	Residue	Modelled	Actual	Comment	Reference
C	1249	GLY	-	expression tag	UNP P0DTC2
C	1250	HIS	-	expression tag	UNP P0DTC2
C	1251	HIS	-	expression tag	UNP P0DTC2
C	1252	HIS	-	expression tag	UNP P0DTC2
C	1253	HIS	-	expression tag	UNP P0DTC2
C	1254	HIS	-	expression tag	UNP P0DTC2
C	1255	HIS	-	expression tag	UNP P0DTC2
C	1256	HIS	-	expression tag	UNP P0DTC2
C	1257	HIS	-	expression tag	UNP P0DTC2
C	1258	SER	-	expression tag	UNP P0DTC2
C	1259	ALA	-	expression tag	UNP P0DTC2
C	1260	TRP	-	expression tag	UNP P0DTC2
C	1261	SER	-	expression tag	UNP P0DTC2
C	1262	HIS	-	expression tag	UNP P0DTC2
C	1263	PRO	-	expression tag	UNP P0DTC2
C	1264	GLN	-	expression tag	UNP P0DTC2
C	1265	PHE	-	expression tag	UNP P0DTC2
C	1266	GLU	-	expression tag	UNP P0DTC2
C	1267	LYS	-	expression tag	UNP P0DTC2
C	1268	GLY	-	expression tag	UNP P0DTC2
C	1269	GLY	-	expression tag	UNP P0DTC2
C	1270	GLY	-	expression tag	UNP P0DTC2
C	1271	SER	-	expression tag	UNP P0DTC2
C	1272	GLY	-	expression tag	UNP P0DTC2
C	1273	GLY	-	expression tag	UNP P0DTC2
C	1274	GLY	-	expression tag	UNP P0DTC2
C	1275	GLY	-	expression tag	UNP P0DTC2
C	1276	SER	-	expression tag	UNP P0DTC2
C	1277	GLY	-	expression tag	UNP P0DTC2
C	1278	GLY	-	expression tag	UNP P0DTC2
C	1279	SER	-	expression tag	UNP P0DTC2
C	1280	ALA	-	expression tag	UNP P0DTC2
C	1281	TRP	-	expression tag	UNP P0DTC2
C	1282	SER	-	expression tag	UNP P0DTC2
C	1283	HIS	-	expression tag	UNP P0DTC2
C	1284	PRO	-	expression tag	UNP P0DTC2
C	1285	GLN	-	expression tag	UNP P0DTC2
C	1286	PHE	-	expression tag	UNP P0DTC2
C	1287	GLU	-	expression tag	UNP P0DTC2
C	1288	LYS	-	expression tag	UNP P0DTC2
B	682	GLY	ARG	conflict	UNP P0DTC2
B	683	SER	ARG	conflict	UNP P0DTC2

Continued on next page...

Continued from previous page...

Chain	Residue	Modelled	Actual	Comment	Reference
B	685	SER	ARG	conflict	UNP P0DTC2
B	986	PRO	LYS	conflict	UNP P0DTC2
B	987	PRO	VAL	conflict	UNP P0DTC2
B	1209	GLY	-	expression tag	UNP P0DTC2
B	1210	SER	-	expression tag	UNP P0DTC2
B	1211	GLY	-	expression tag	UNP P0DTC2
B	1212	TYR	-	expression tag	UNP P0DTC2
B	1213	ILE	-	expression tag	UNP P0DTC2
B	1214	PRO	-	expression tag	UNP P0DTC2
B	1215	GLU	-	expression tag	UNP P0DTC2
B	1216	ALA	-	expression tag	UNP P0DTC2
B	1217	PRO	-	expression tag	UNP P0DTC2
B	1218	ARG	-	expression tag	UNP P0DTC2
B	1219	ASP	-	expression tag	UNP P0DTC2
B	1220	GLY	-	expression tag	UNP P0DTC2
B	1221	GLN	-	expression tag	UNP P0DTC2
B	1222	ALA	-	expression tag	UNP P0DTC2
B	1223	TYR	-	expression tag	UNP P0DTC2
B	1224	VAL	-	expression tag	UNP P0DTC2
B	1225	ARG	-	expression tag	UNP P0DTC2
B	1226	LYS	-	expression tag	UNP P0DTC2
B	1227	ASP	-	expression tag	UNP P0DTC2
B	1228	GLY	-	expression tag	UNP P0DTC2
B	1229	GLU	-	expression tag	UNP P0DTC2
B	1230	TRP	-	expression tag	UNP P0DTC2
B	1231	VAL	-	expression tag	UNP P0DTC2
B	1232	LEU	-	expression tag	UNP P0DTC2
B	1233	LEU	-	expression tag	UNP P0DTC2
B	1234	SER	-	expression tag	UNP P0DTC2
B	1235	THR	-	expression tag	UNP P0DTC2
B	1236	PHE	-	expression tag	UNP P0DTC2
B	1237	LEU	-	expression tag	UNP P0DTC2
B	1238	GLY	-	expression tag	UNP P0DTC2
B	1239	ARG	-	expression tag	UNP P0DTC2
B	1240	SER	-	expression tag	UNP P0DTC2
B	1241	LEU	-	expression tag	UNP P0DTC2
B	1242	GLU	-	expression tag	UNP P0DTC2
B	1243	VAL	-	expression tag	UNP P0DTC2
B	1244	LEU	-	expression tag	UNP P0DTC2
B	1245	PHE	-	expression tag	UNP P0DTC2
B	1246	GLN	-	expression tag	UNP P0DTC2
B	1247	GLY	-	expression tag	UNP P0DTC2

Continued on next page...

Continued from previous page...

Chain	Residue	Modelled	Actual	Comment	Reference
B	1248	PRO	-	expression tag	UNP P0DTC2
B	1249	GLY	-	expression tag	UNP P0DTC2
B	1250	HIS	-	expression tag	UNP P0DTC2
B	1251	HIS	-	expression tag	UNP P0DTC2
B	1252	HIS	-	expression tag	UNP P0DTC2
B	1253	HIS	-	expression tag	UNP P0DTC2
B	1254	HIS	-	expression tag	UNP P0DTC2
B	1255	HIS	-	expression tag	UNP P0DTC2
B	1256	HIS	-	expression tag	UNP P0DTC2
B	1257	HIS	-	expression tag	UNP P0DTC2
B	1258	SER	-	expression tag	UNP P0DTC2
B	1259	ALA	-	expression tag	UNP P0DTC2
B	1260	TRP	-	expression tag	UNP P0DTC2
B	1261	SER	-	expression tag	UNP P0DTC2
B	1262	HIS	-	expression tag	UNP P0DTC2
B	1263	PRO	-	expression tag	UNP P0DTC2
B	1264	GLN	-	expression tag	UNP P0DTC2
B	1265	PHE	-	expression tag	UNP P0DTC2
B	1266	GLU	-	expression tag	UNP P0DTC2
B	1267	LYS	-	expression tag	UNP P0DTC2
B	1268	GLY	-	expression tag	UNP P0DTC2
B	1269	GLY	-	expression tag	UNP P0DTC2
B	1270	GLY	-	expression tag	UNP P0DTC2
B	1271	SER	-	expression tag	UNP P0DTC2
B	1272	GLY	-	expression tag	UNP P0DTC2
B	1273	GLY	-	expression tag	UNP P0DTC2
B	1274	GLY	-	expression tag	UNP P0DTC2
B	1275	GLY	-	expression tag	UNP P0DTC2
B	1276	SER	-	expression tag	UNP P0DTC2
B	1277	GLY	-	expression tag	UNP P0DTC2
B	1278	GLY	-	expression tag	UNP P0DTC2
B	1279	SER	-	expression tag	UNP P0DTC2
B	1280	ALA	-	expression tag	UNP P0DTC2
B	1281	TRP	-	expression tag	UNP P0DTC2
B	1282	SER	-	expression tag	UNP P0DTC2
B	1283	HIS	-	expression tag	UNP P0DTC2
B	1284	PRO	-	expression tag	UNP P0DTC2
B	1285	GLN	-	expression tag	UNP P0DTC2
B	1286	PHE	-	expression tag	UNP P0DTC2
B	1287	GLU	-	expression tag	UNP P0DTC2
B	1288	LYS	-	expression tag	UNP P0DTC2
A	682	GLY	ARG	conflict	UNP P0DTC2

Continued on next page...

Continued from previous page...

Chain	Residue	Modelled	Actual	Comment	Reference
A	683	SER	ARG	conflict	UNP P0DTC2
A	685	SER	ARG	conflict	UNP P0DTC2
A	986	PRO	LYS	conflict	UNP P0DTC2
A	987	PRO	VAL	conflict	UNP P0DTC2
A	1209	GLY	-	expression tag	UNP P0DTC2
A	1210	SER	-	expression tag	UNP P0DTC2
A	1211	GLY	-	expression tag	UNP P0DTC2
A	1212	TYR	-	expression tag	UNP P0DTC2
A	1213	ILE	-	expression tag	UNP P0DTC2
A	1214	PRO	-	expression tag	UNP P0DTC2
A	1215	GLU	-	expression tag	UNP P0DTC2
A	1216	ALA	-	expression tag	UNP P0DTC2
A	1217	PRO	-	expression tag	UNP P0DTC2
A	1218	ARG	-	expression tag	UNP P0DTC2
A	1219	ASP	-	expression tag	UNP P0DTC2
A	1220	GLY	-	expression tag	UNP P0DTC2
A	1221	GLN	-	expression tag	UNP P0DTC2
A	1222	ALA	-	expression tag	UNP P0DTC2
A	1223	TYR	-	expression tag	UNP P0DTC2
A	1224	VAL	-	expression tag	UNP P0DTC2
A	1225	ARG	-	expression tag	UNP P0DTC2
A	1226	LYS	-	expression tag	UNP P0DTC2
A	1227	ASP	-	expression tag	UNP P0DTC2
A	1228	GLY	-	expression tag	UNP P0DTC2
A	1229	GLU	-	expression tag	UNP P0DTC2
A	1230	TRP	-	expression tag	UNP P0DTC2
A	1231	VAL	-	expression tag	UNP P0DTC2
A	1232	LEU	-	expression tag	UNP P0DTC2
A	1233	LEU	-	expression tag	UNP P0DTC2
A	1234	SER	-	expression tag	UNP P0DTC2
A	1235	THR	-	expression tag	UNP P0DTC2
A	1236	PHE	-	expression tag	UNP P0DTC2
A	1237	LEU	-	expression tag	UNP P0DTC2
A	1238	GLY	-	expression tag	UNP P0DTC2
A	1239	ARG	-	expression tag	UNP P0DTC2
A	1240	SER	-	expression tag	UNP P0DTC2
A	1241	LEU	-	expression tag	UNP P0DTC2
A	1242	GLU	-	expression tag	UNP P0DTC2
A	1243	VAL	-	expression tag	UNP P0DTC2
A	1244	LEU	-	expression tag	UNP P0DTC2
A	1245	PHE	-	expression tag	UNP P0DTC2
A	1246	GLN	-	expression tag	UNP P0DTC2

Continued on next page...

Continued from previous page...

Chain	Residue	Modelled	Actual	Comment	Reference
A	1247	GLY	-	expression tag	UNP P0DTC2
A	1248	PRO	-	expression tag	UNP P0DTC2
A	1249	GLY	-	expression tag	UNP P0DTC2
A	1250	HIS	-	expression tag	UNP P0DTC2
A	1251	HIS	-	expression tag	UNP P0DTC2
A	1252	HIS	-	expression tag	UNP P0DTC2
A	1253	HIS	-	expression tag	UNP P0DTC2
A	1254	HIS	-	expression tag	UNP P0DTC2
A	1255	HIS	-	expression tag	UNP P0DTC2
A	1256	HIS	-	expression tag	UNP P0DTC2
A	1257	HIS	-	expression tag	UNP P0DTC2
A	1258	SER	-	expression tag	UNP P0DTC2
A	1259	ALA	-	expression tag	UNP P0DTC2
A	1260	TRP	-	expression tag	UNP P0DTC2
A	1261	SER	-	expression tag	UNP P0DTC2
A	1262	HIS	-	expression tag	UNP P0DTC2
A	1263	PRO	-	expression tag	UNP P0DTC2
A	1264	GLN	-	expression tag	UNP P0DTC2
A	1265	PHE	-	expression tag	UNP P0DTC2
A	1266	GLU	-	expression tag	UNP P0DTC2
A	1267	LYS	-	expression tag	UNP P0DTC2
A	1268	GLY	-	expression tag	UNP P0DTC2
A	1269	GLY	-	expression tag	UNP P0DTC2
A	1270	GLY	-	expression tag	UNP P0DTC2
A	1271	SER	-	expression tag	UNP P0DTC2
A	1272	GLY	-	expression tag	UNP P0DTC2
A	1273	GLY	-	expression tag	UNP P0DTC2
A	1274	GLY	-	expression tag	UNP P0DTC2
A	1275	GLY	-	expression tag	UNP P0DTC2
A	1276	SER	-	expression tag	UNP P0DTC2
A	1277	GLY	-	expression tag	UNP P0DTC2
A	1278	GLY	-	expression tag	UNP P0DTC2
A	1279	SER	-	expression tag	UNP P0DTC2
A	1280	ALA	-	expression tag	UNP P0DTC2
A	1281	TRP	-	expression tag	UNP P0DTC2
A	1282	SER	-	expression tag	UNP P0DTC2
A	1283	HIS	-	expression tag	UNP P0DTC2
A	1284	PRO	-	expression tag	UNP P0DTC2
A	1285	GLN	-	expression tag	UNP P0DTC2
A	1286	PHE	-	expression tag	UNP P0DTC2
A	1287	GLU	-	expression tag	UNP P0DTC2
A	1288	LYS	-	expression tag	UNP P0DTC2

- Molecule 4 is an oligosaccharide called 2-acetamido-2-deoxy-beta-D-glucopyranose-(1-4)-2-acetamido-2-deoxy-beta-D-glucopyranose.



Mol	Chain	Residues	Atoms				AltConf	Trace
			Total	C	N	O		
4	I	2	28	16	2	10	0	0
4	J	2	28	16	2	10	0	0
4	K	2	28	16	2	10	0	0
4	M	2	28	16	2	10	0	0
4	N	2	28	16	2	10	0	0
4	O	2	28	16	2	10	0	0
4	P	2	28	16	2	10	0	0
4	Q	2	28	16	2	10	0	0
4	R	2	28	16	2	10	0	0
4	S	2	28	16	2	10	0	0
4	T	2	28	16	2	10	0	0
4	U	2	28	16	2	10	0	0
4	V	2	28	16	2	10	0	0
4	W	2	28	16	2	10	0	0
4	X	2	28	16	2	10	0	0
4	Y	2	28	16	2	10	0	0
4	Z	2	28	16	2	10	0	0
4	a	2	28	16	2	10	0	0

Continued on next page...

Continued from previous page...

Mol	Chain	Residues	Atoms				AltConf	Trace
4	b	2	Total	C	N	O	0	0
			28	16	2	10		
4	c	2	Total	C	N	O	0	0
			28	16	2	10		
4	d	2	Total	C	N	O	0	0
			28	16	2	10		
4	e	2	Total	C	N	O	0	0
			28	16	2	10		
4	f	2	Total	C	N	O	0	0
			28	16	2	10		
4	g	2	Total	C	N	O	0	0
			28	16	2	10		
4	h	2	Total	C	N	O	0	0
			28	16	2	10		
4	i	2	Total	C	N	O	0	0
			28	16	2	10		
4	j	2	Total	C	N	O	0	0
			28	16	2	10		
4	k	2	Total	C	N	O	0	0
			28	16	2	10		
4	l	2	Total	C	N	O	0	0
			28	16	2	10		

- Molecule 5 is 2-acetamido-2-deoxy-beta-D-glucopyranose (three-letter code: NAG) (formula: $C_8H_{15}NO_6$) (labeled as "Ligand of Interest" by depositor).

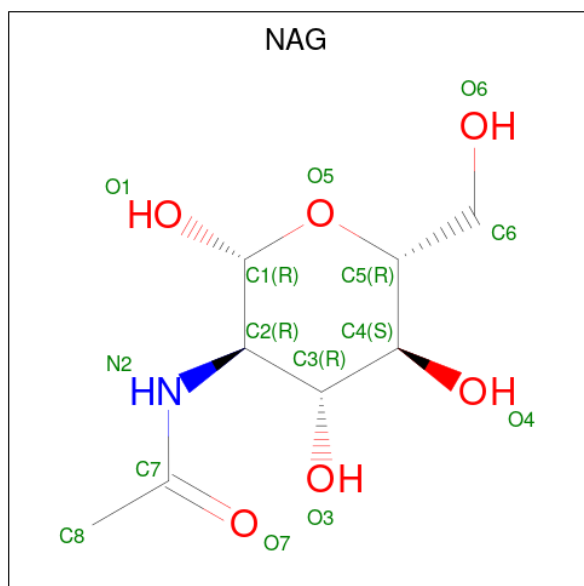

Mol	Chain	Residues	Atoms				AltConf
5	C	1	Total	C	N	O	0
			14	8	1	5	
5	C	1	Total	C	N	O	0
			14	8	1	5	
5	C	1	Total	C	N	O	0
			14	8	1	5	
5	C	1	Total	C	N	O	0
			14	8	1	5	
5	C	1	Total	C	N	O	0
			14	8	1	5	
5	C	1	Total	C	N	O	0
			14	8	1	5	
5	C	1	Total	C	N	O	0
			14	8	1	5	
5	B	1	Total	C	N	O	0
			14	8	1	5	
5	B	1	Total	C	N	O	0
			14	8	1	5	
5	B	1	Total	C	N	O	0
			14	8	1	5	
5	B	1	Total	C	N	O	0
			14	8	1	5	
5	B	1	Total	C	N	O	0
			14	8	1	5	
5	B	1	Total	C	N	O	0
			14	8	1	5	
5	B	1	Total	C	N	O	0
			14	8	1	5	
5	B	1	Total	C	N	O	0
			14	8	1	5	
5	A	1	Total	C	N	O	0
			14	8	1	5	
5	A	1	Total	C	N	O	0
			14	8	1	5	
5	A	1	Total	C	N	O	0
			14	8	1	5	
5	A	1	Total	C	N	O	0
			14	8	1	5	

Continued on next page...

Continued from previous page...

Mol	Chain	Residues	Atoms				AltConf
			Total	C	N	O	
5	A	1	Total 14	8	1	5	0
5	A	1	Total 14	8	1	5	0
5	A	1	Total 14	8	1	5	0

3 Residue-property plots [i](#)

These plots are drawn for all protein, RNA, DNA and oligosaccharide chains in the entry. The first graphic for a chain summarises the proportions of the various outlier classes displayed in the second graphic. The second graphic shows the sequence view annotated by issues in geometry and atom inclusion in map density. Residues are color-coded according to the number of geometric quality criteria for which they contain at least one outlier: green = 0, yellow = 1, orange = 2 and red = 3 or more. A red diamond above a residue indicates a poor fit to the EM map for this residue (all-atom inclusion < 40%). Stretches of 2 or more consecutive residues without any outlier are shown as a green connector. Residues present in the sample, but not in the model, are shown in grey.

- Molecule 1: Fab of antibody clone 2, light chain

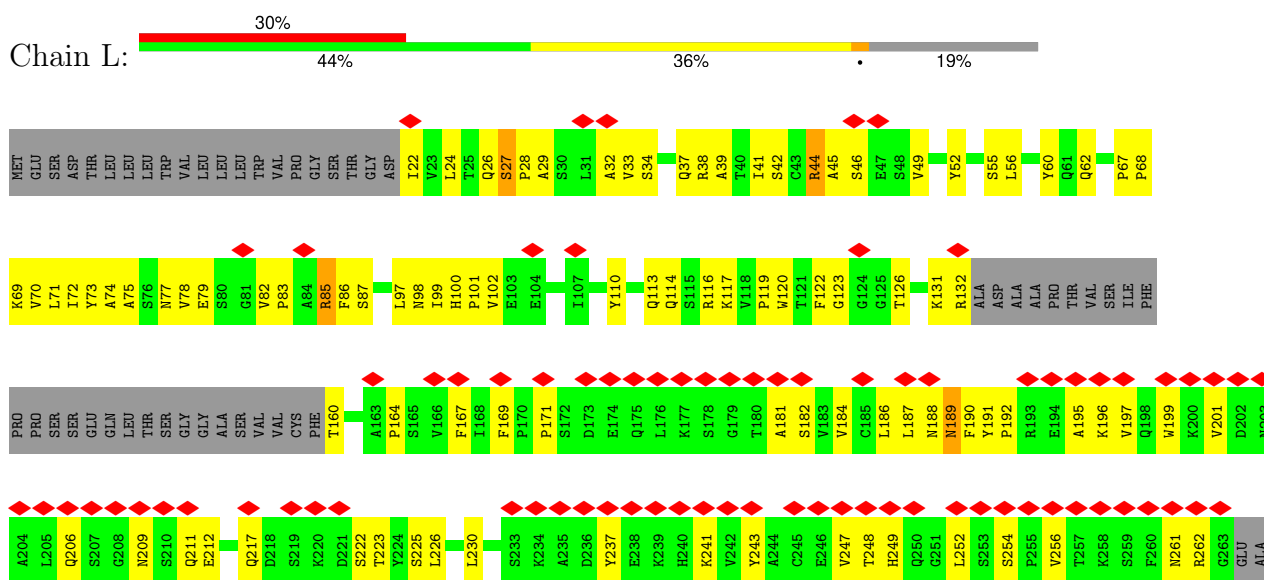

- Molecule 1: Fab of antibody clone 2, light chain

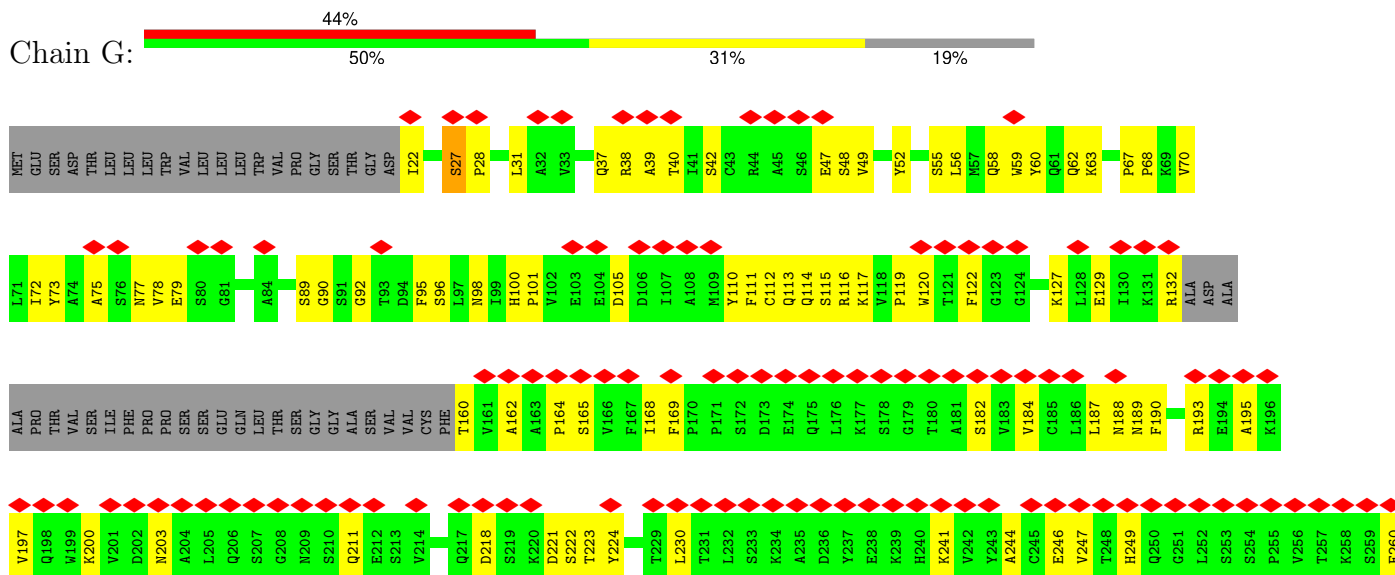

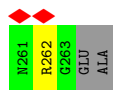

• Molecule 1: Fab of antibody clone 2, light chain

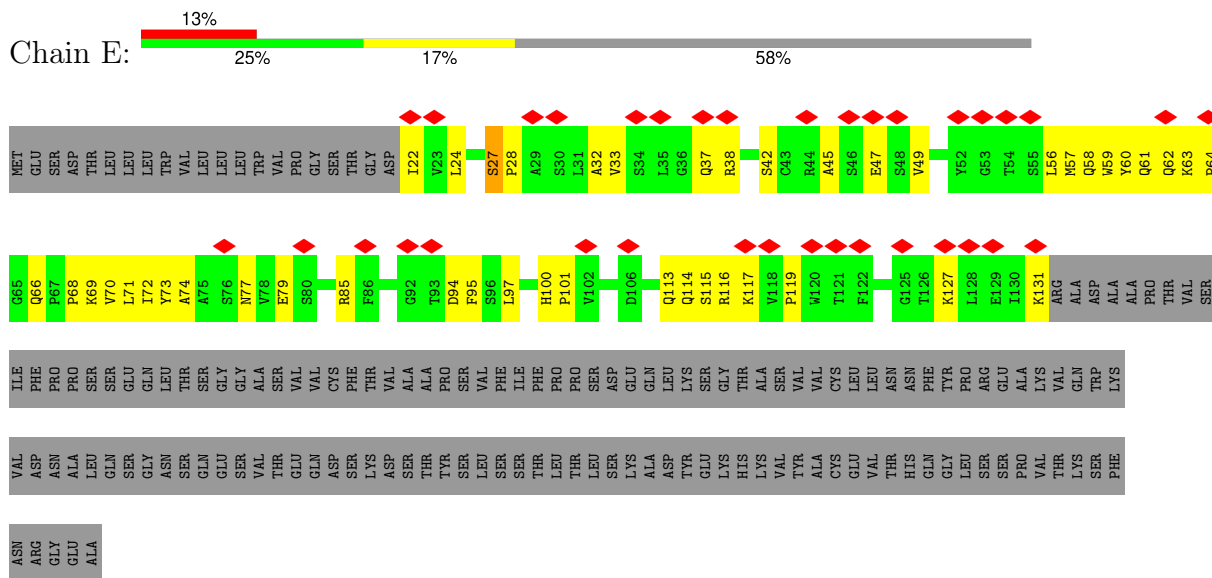

• Molecule 2: Fab of antibody clone 2, heavy chain

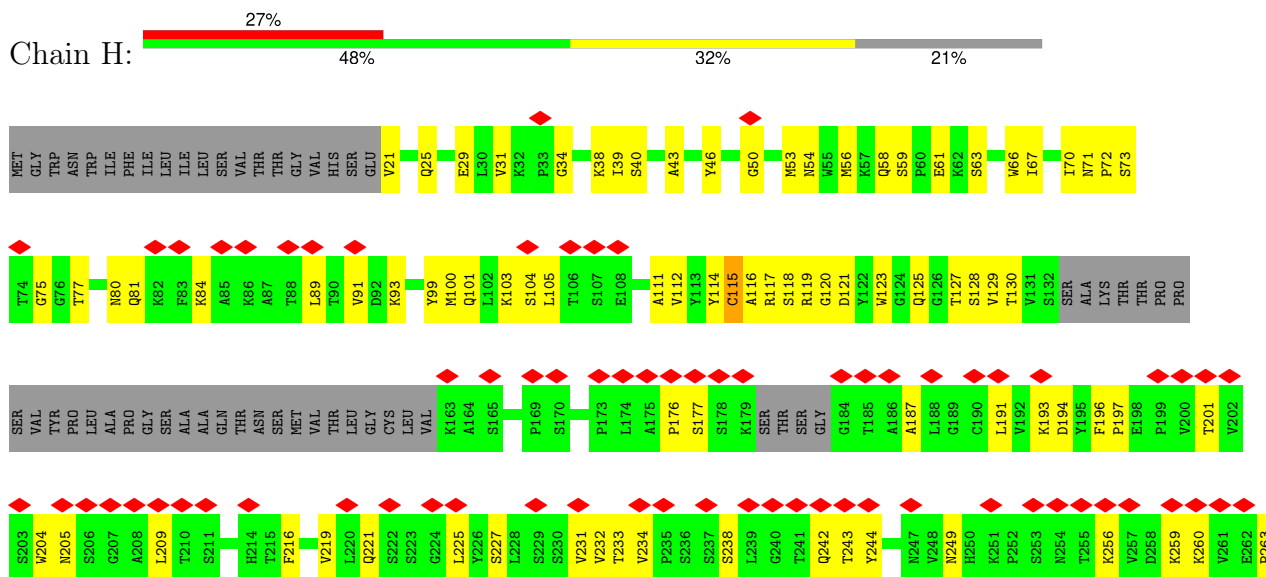

• Molecule 2: Fab of antibody clone 2, heavy chain

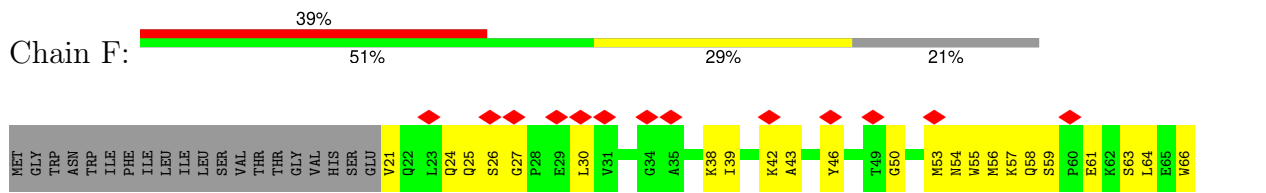

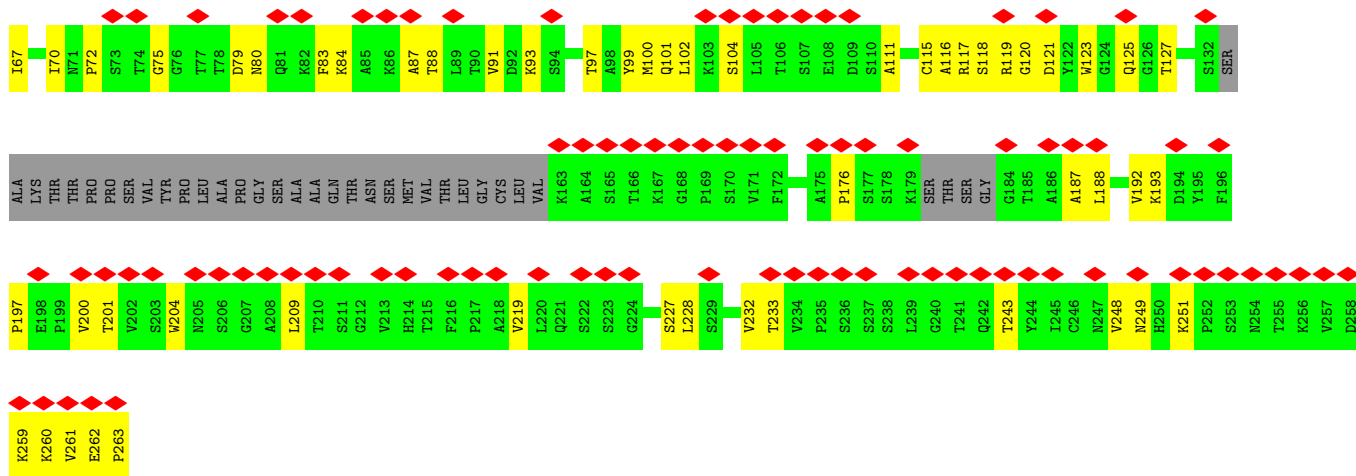

● Molecule 2: Fab of antibody clone 2, heavy chain

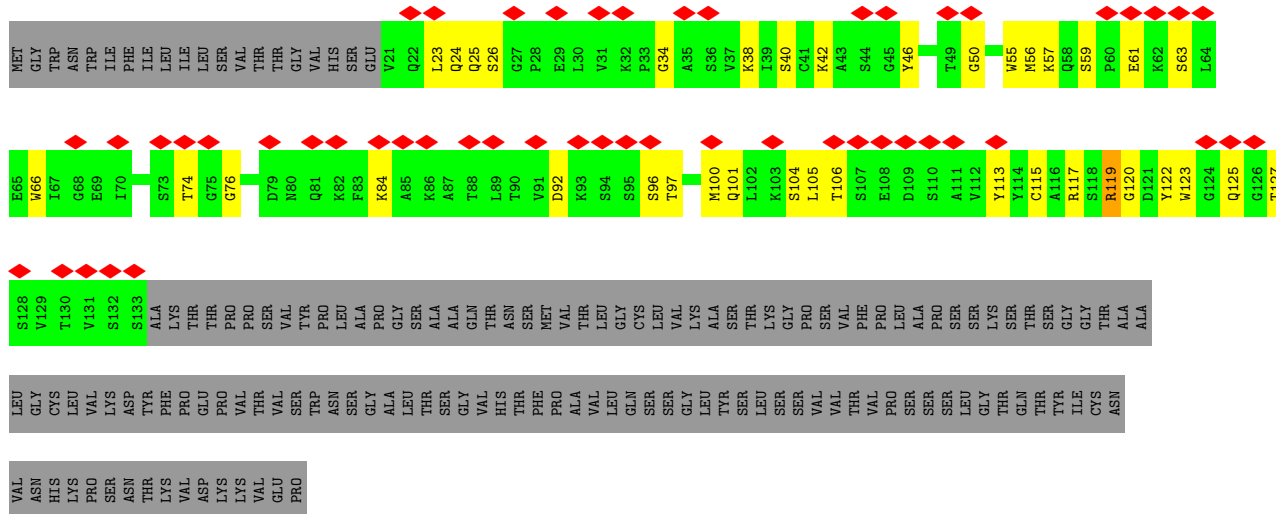

● Molecule 3: Spike glycoprotein

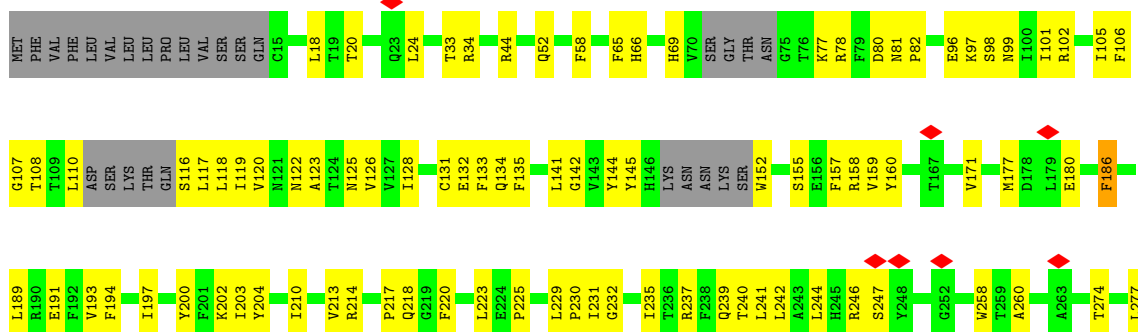

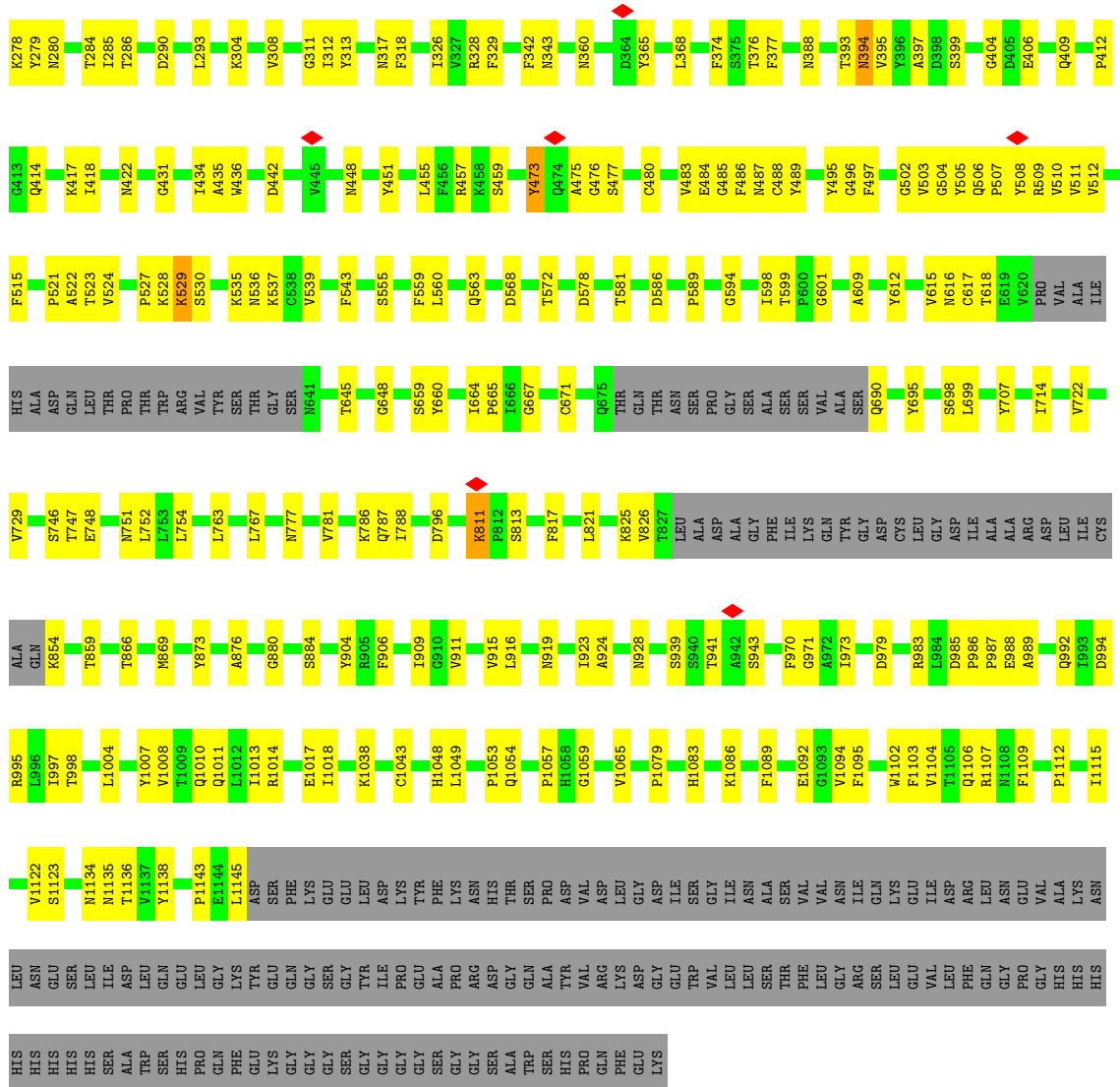

• Molecule 3: Spike glycoprotein

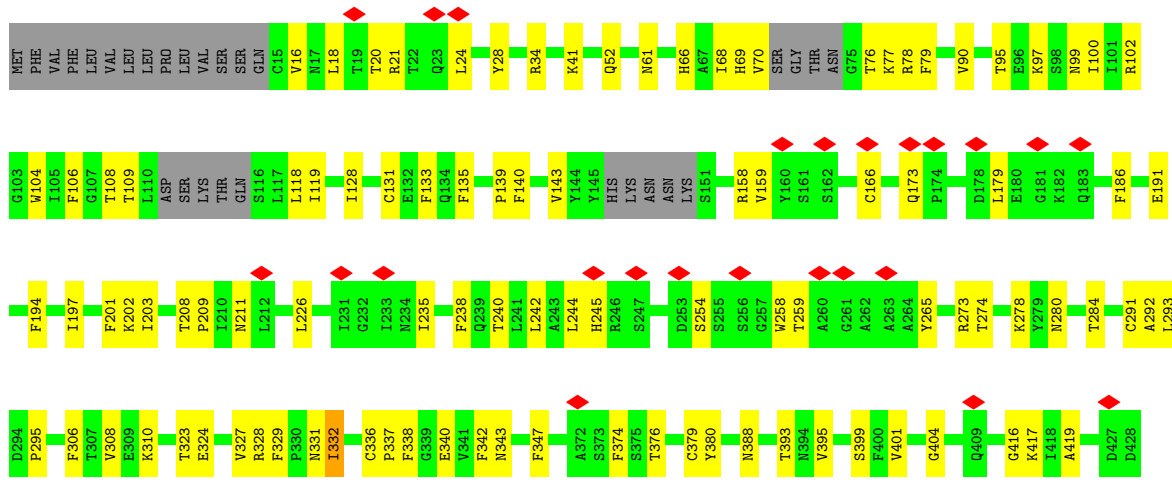

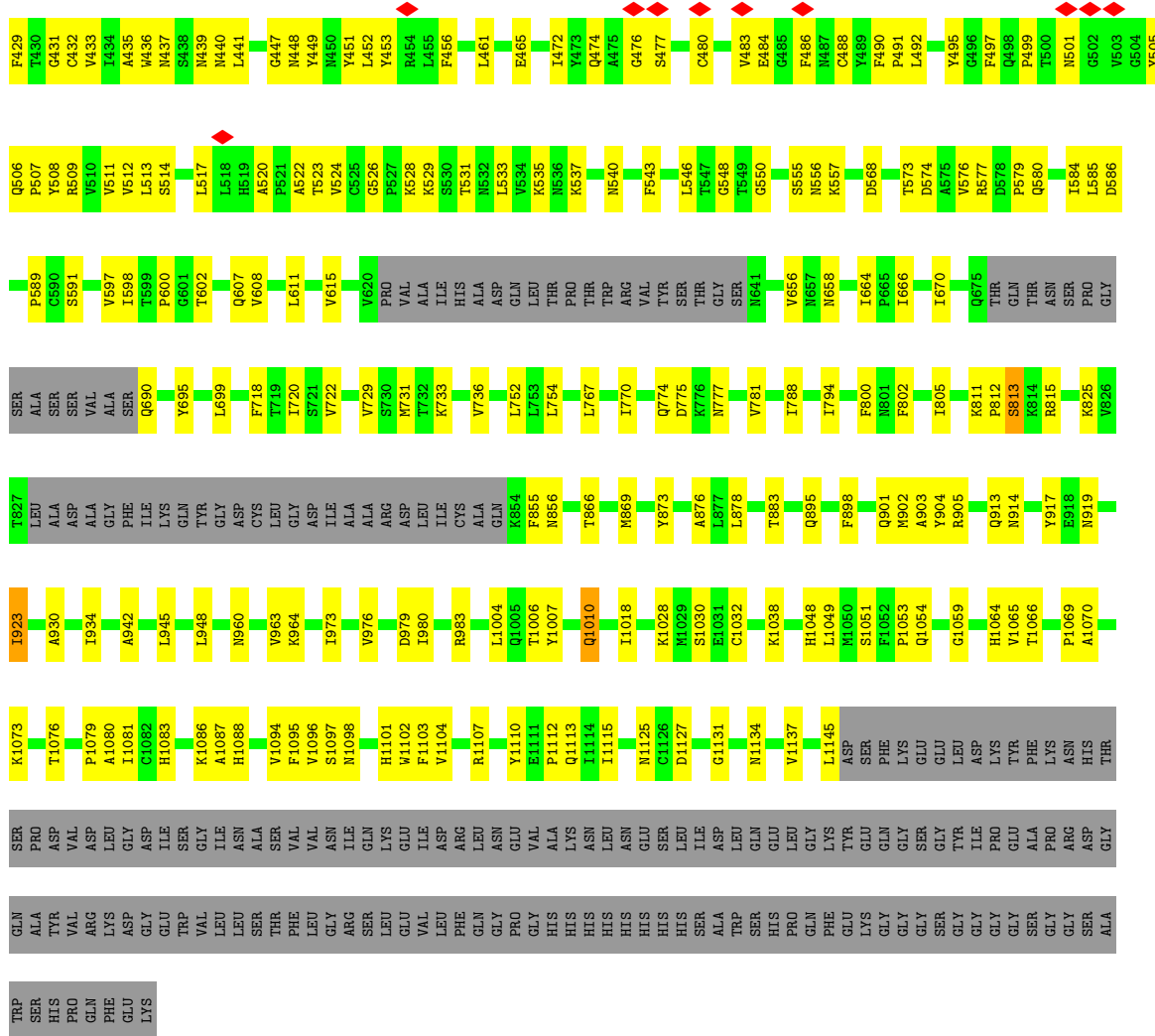

• Molecule 3: Spike glycoprotein

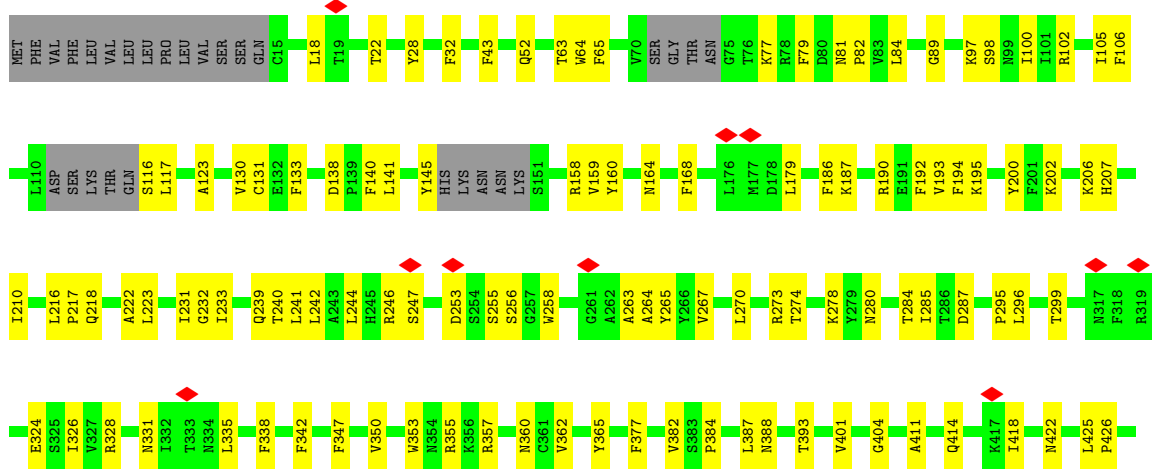

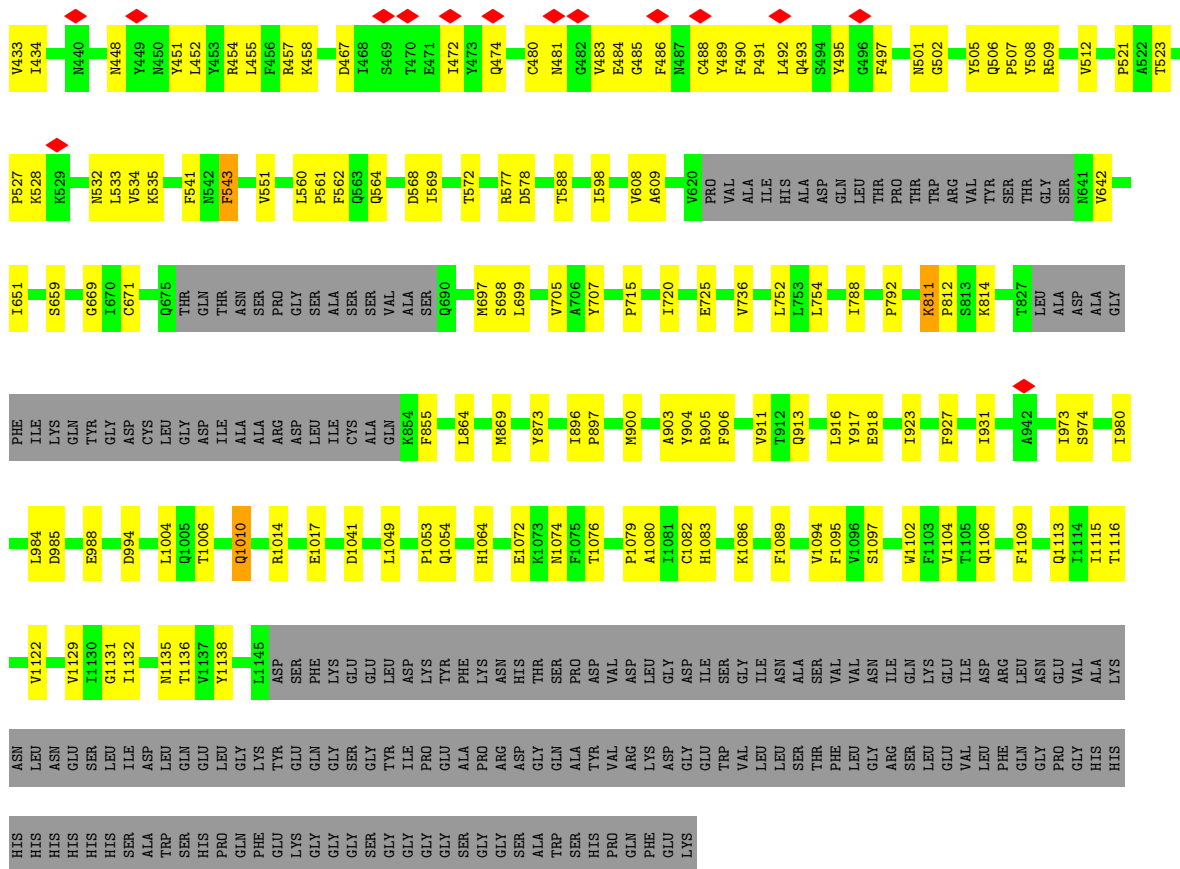

● Molecule 4: 2-acetamido-2-deoxy-beta-D-glucopyranose-(1-4)-2-acetamido-2-deoxy-beta-D-glucopyranose



● Molecule 4: 2-acetamido-2-deoxy-beta-D-glucopyranose-(1-4)-2-acetamido-2-deoxy-beta-D-glucopyranose



● Molecule 4: 2-acetamido-2-deoxy-beta-D-glucopyranose-(1-4)-2-acetamido-2-deoxy-beta-D-glucopyranose



- Molecule 4: 2-acetamido-2-deoxy-beta-D-glucopyranose-(1-4)-2-acetamido-2-deoxy-beta-D-glucopyranose

Chain M:  50% 50%



- Molecule 4: 2-acetamido-2-deoxy-beta-D-glucopyranose-(1-4)-2-acetamido-2-deoxy-beta-D-glucopyranose

Chain N:  100%



- Molecule 4: 2-acetamido-2-deoxy-beta-D-glucopyranose-(1-4)-2-acetamido-2-deoxy-beta-D-glucopyranose

Chain O:  50% 50%



- Molecule 4: 2-acetamido-2-deoxy-beta-D-glucopyranose-(1-4)-2-acetamido-2-deoxy-beta-D-glucopyranose

Chain P:  100%



- Molecule 4: 2-acetamido-2-deoxy-beta-D-glucopyranose-(1-4)-2-acetamido-2-deoxy-beta-D-glucopyranose

Chain Q:  50% 100%



- Molecule 4: 2-acetamido-2-deoxy-beta-D-glucopyranose-(1-4)-2-acetamido-2-deoxy-beta-D-glucopyranose

Chain R:  100%



- Molecule 4: 2-acetamido-2-deoxy-beta-D-glucopyranose-(1-4)-2-acetamido-2-deoxy-beta-D-glucopyranose

Chain S:  100%



- Molecule 4: 2-acetamido-2-deoxy-beta-D-glucopyranose-(1-4)-2-acetamido-2-deoxy-beta-D-glucopyranose

Chain T:  50% 50%



- Molecule 4: 2-acetamido-2-deoxy-beta-D-glucopyranose-(1-4)-2-acetamido-2-deoxy-beta-D-glucopyranose

Chain U:  50% 50%



- Molecule 4: 2-acetamido-2-deoxy-beta-D-glucopyranose-(1-4)-2-acetamido-2-deoxy-beta-D-glucopyranose

Chain V:  50% 50%



- Molecule 4: 2-acetamido-2-deoxy-beta-D-glucopyranose-(1-4)-2-acetamido-2-deoxy-beta-D-glucopyranose

Chain W:  50% 50%



- Molecule 4: 2-acetamido-2-deoxy-beta-D-glucopyranose-(1-4)-2-acetamido-2-deoxy-beta-D-glucopyranose

Chain X:  100%



- Molecule 4: 2-acetamido-2-deoxy-beta-D-glucopyranose-(1-4)-2-acetamido-2-deoxy-beta-D-glucopyranose

Chain Y:  100%



- Molecule 4: 2-acetamido-2-deoxy-beta-D-glucopyranose-(1-4)-2-acetamido-2-deoxy-beta-D-glucopyranose



- Molecule 4: 2-acetamido-2-deoxy-beta-D-glucopyranose-(1-4)-2-acetamido-2-deoxy-beta-D-glucopyranose



- Molecule 4: 2-acetamido-2-deoxy-beta-D-glucopyranose-(1-4)-2-acetamido-2-deoxy-beta-D-glucopyranose



- Molecule 4: 2-acetamido-2-deoxy-beta-D-glucopyranose-(1-4)-2-acetamido-2-deoxy-beta-D-glucopyranose



- Molecule 4: 2-acetamido-2-deoxy-beta-D-glucopyranose-(1-4)-2-acetamido-2-deoxy-beta-D-glucopyranose



- Molecule 4: 2-acetamido-2-deoxy-beta-D-glucopyranose-(1-4)-2-acetamido-2-deoxy-beta-D-glucopyranose



- Molecule 4: 2-acetamido-2-deoxy-beta-D-glucopyranose-(1-4)-2-acetamido-2-deoxy-beta-D-glucopyranose



- Molecule 4: 2-acetamido-2-deoxy-beta-D-glucopyranose-(1-4)-2-acetamido-2-deoxy-beta-D-glucopyranose



- Molecule 4: 2-acetamido-2-deoxy-beta-D-glucopyranose-(1-4)-2-acetamido-2-deoxy-beta-D-glucopyranose



- Molecule 4: 2-acetamido-2-deoxy-beta-D-glucopyranose-(1-4)-2-acetamido-2-deoxy-beta-D-glucopyranose



- Molecule 4: 2-acetamido-2-deoxy-beta-D-glucopyranose-(1-4)-2-acetamido-2-deoxy-beta-D-glucopyranose



- Molecule 4: 2-acetamido-2-deoxy-beta-D-glucopyranose-(1-4)-2-acetamido-2-deoxy-beta-D-glucopyranose



- Molecule 4: 2-acetamido-2-deoxy-beta-D-glucofuranose-(1-4)-2-acetamido-2-deoxy-beta-D-glucopyranose

Chain 1:

100%

1AC2
1AC2

4 Experimental information

Property	Value	Source
EM reconstruction method	SINGLE PARTICLE	Depositor
Imposed symmetry	POINT, Not provided	
Number of particles used	135336	Depositor
Resolution determination method	FSC 0.143 CUT-OFF	Depositor
CTF correction method	NONE	Depositor
Microscope	FEI TITAN KRIOS	Depositor
Voltage (kV)	300	Depositor
Electron dose ($e^-/\text{\AA}^2$)	66.5	Depositor
Minimum defocus (nm)	700	Depositor
Maximum defocus (nm)	2500	Depositor
Magnification	Not provided	
Image detector	GATAN K3 (6k x 4k)	Depositor
Maximum map value	0.125	Depositor
Minimum map value	-0.000	Depositor
Average map value	0.000	Depositor
Map value standard deviation	0.003	Depositor
Recommended contour level	0.022	Depositor
Map size (\AA)	410.112, 410.112, 410.112	wwPDB
Map dimensions	384, 384, 384	wwPDB
Map angles ($^\circ$)	90.0, 90.0, 90.0	wwPDB
Pixel spacing (\AA)	1.068, 1.068, 1.068	Depositor

5 Model quality i

5.1 Standard geometry i

Bond lengths and bond angles in the following residue types are not validated in this section: NAG

The Z score for a bond length (or angle) is the number of standard deviations the observed value is removed from the expected value. A bond length (or angle) with $|Z| > 5$ is considered an outlier worth inspection. RMSZ is the root-mean-square of all Z scores of the bond lengths (or angles).

Mol	Chain	Bond lengths		Bond angles	
		RMSZ	# Z >5	RMSZ	# Z >5
1	E	0.26	0/848	0.58	0/1151
1	G	0.26	0/1676	0.50	0/2276
1	L	0.27	0/1676	0.52	0/2276
2	D	0.27	0/860	0.56	0/1165
2	F	0.25	0/1576	0.51	0/2146
2	H	0.26	0/1576	0.54	1/2146 (0.0%)
3	A	0.27	0/8334	0.49	0/11357
3	B	0.27	0/8334	0.49	0/11357
3	C	0.26	0/8339	0.50	0/11364
All	All	0.27	0/33219	0.50	1/45238 (0.0%)

Chiral center outliers are detected by calculating the chiral volume of a chiral center and verifying if the center is modelled as a planar moiety or with the opposite hand. A planarity outlier is detected by checking planarity of atoms in a peptide group, atoms in a mainchain group or atoms of a sidechain that are expected to be planar.

Mol	Chain	#Chirality outliers	#Planarity outliers
1	E	0	1
1	G	0	1
1	L	0	1
3	A	0	2
3	B	0	3
3	C	0	3
All	All	0	11

There are no bond length outliers.

All (1) bond angle outliers are listed below:

Mol	Chain	Res	Type	Atoms	Z	Observed(°)	Ideal(°)
2	H	115	CYS	CA-CB-SG	6.09	124.95	114.00

There are no chirality outliers.

All (11) planarity outliers are listed below:

Mol	Chain	Res	Type	Group
3	A	811	LYS	Peptide
3	A	812	PRO	Peptide
3	B	1070	ALA	Peptide
3	B	811	LYS	Peptide
3	B	923	ILE	Peptide
3	C	473	TYR	Peptide
3	C	811	LYS	Peptide
3	C	923	ILE	Peptide
1	E	27	SER	Peptide
1	G	27	SER	Peptide
1	L	27	SER	Peptide

5.2 Too-close contacts [i](#)

In the following table, the Non-H and H(model) columns list the number of non-hydrogen atoms and hydrogen atoms in the chain respectively. The H(added) column lists the number of hydrogen atoms added and optimized by MolProbity. The Clashes column lists the number of clashes within the asymmetric unit, whereas Symm-Clashes lists symmetry-related clashes.

Mol	Chain	Non-H	H(model)	H(added)	Clashes	Symm-Clashes
1	E	829	0	809	31	0
1	G	1640	0	1597	65	0
1	L	1640	0	1597	79	0
2	D	843	0	803	35	0
2	F	1541	0	1503	59	0
2	H	1541	0	1503	60	0
3	A	8145	0	7857	199	0
3	B	8145	0	7855	225	0
3	C	8149	0	7861	221	0
4	I	28	0	25	0	0
4	J	28	0	25	0	0
4	K	28	0	25	0	0
4	M	28	0	25	1	0
4	N	28	0	25	0	0
4	O	28	0	25	1	0
4	P	28	0	25	0	0
4	Q	28	0	25	0	0
4	R	28	0	25	2	0
4	S	28	0	25	0	0

Continued on next page...

Continued from previous page...

Mol	Chain	Non-H	H(model)	H(added)	Clashes	Symm-Clashes
4	T	28	0	25	1	0
4	U	28	0	25	1	0
4	V	28	0	25	2	0
4	W	28	0	25	0	0
4	X	28	0	25	0	0
4	Y	28	0	25	0	0
4	Z	28	0	25	1	0
4	a	28	0	25	0	0
4	b	28	0	25	0	0
4	c	28	0	25	0	0
4	d	28	0	25	0	0
4	e	28	0	25	0	0
4	f	28	0	25	0	0
4	g	28	0	25	0	0
4	h	28	0	25	0	0
4	i	28	0	25	0	0
4	j	28	0	25	0	0
4	k	28	0	25	0	0
4	l	28	0	25	0	0
5	A	112	0	104	3	0
5	B	126	0	117	0	0
5	C	112	0	104	1	0
All	All	33635	0	32435	910	0

The all-atom clashscore is defined as the number of clashes found per 1000 atoms (including hydrogen atoms). The all-atom clashscore for this structure is 14.

All (910) close contacts within the same asymmetric unit are listed below, sorted by their clash magnitude.

Atom-1	Atom-2	Interatomic distance (Å)	Clash overlap (Å)
1:E:72:ILE:HG22	1:E:74:ALA:H	1.37	0.88
1:G:117:LYS:HG3	1:G:119:PRO:HD2	1.59	0.84
1:E:49:VAL:HG12	1:E:114:GLN:HE21	1.43	0.81
3:B:139:PRO:HB2	3:B:159:VAL:HG12	1.63	0.80
3:B:295:PRO:HB2	3:B:608:VAL:HG21	1.62	0.79
2:F:54:ASN:ND2	2:F:118:SER:O	2.17	0.78
1:L:187:LEU:HB2	1:L:226:LEU:HB3	1.66	0.78
3:A:433:VAL:HG12	3:A:512:VAL:HG12	1.65	0.78
2:D:25:GLN:NE2	2:D:113:TYR:O	2.17	0.78
2:H:53:MET:HB2	2:H:70:ILE:HD11	1.67	0.77
3:A:244:LEU:HD21	3:A:258:TRP:HA	1.67	0.77

Continued on next page...

Continued from previous page...

Atom-1	Atom-2	Interatomic distance (Å)	Clash overlap (Å)
1:L:62:GLN:HB2	1:L:68:PRO:HB3	1.67	0.77
1:L:44:ARG:NH1	1:L:45:ALA:O	2.19	0.76
3:A:360:ASN:H	3:A:523:THR:HB	1.50	0.76
3:C:388:ASN:HD22	3:C:527:PRO:HD2	1.51	0.76
1:L:197:VAL:HG12	1:L:247:VAL:HG22	1.67	0.76
3:C:699:LEU:HB2	3:A:788:ILE:HD11	1.67	0.75
3:A:133:PHE:HB3	3:A:164:ASN:HD21	1.50	0.75
3:B:1076:THR:HG23	3:B:1097:SER:HB3	1.69	0.74
3:A:497:PHE:HE2	3:A:507:PRO:HB3	1.53	0.74
1:G:38:ARG:HH12	1:G:40:THR:HB	1.53	0.73
2:D:55:TRP:CZ3	2:D:115:CYS:HB3	2.23	0.73
2:F:53:MET:HB3	2:F:70:ILE:HD11	1.70	0.73
3:C:599:THR:HG22	3:C:601:GLY:H	1.53	0.72
3:A:97:LYS:HA	3:A:187:LYS:HB2	1.71	0.72
3:B:331:ASN:OD1	3:B:332:ILE:N	2.22	0.72
2:D:57:LYS:HG2	2:D:113:TYR:HD1	1.54	0.72
3:B:718:PHE:HA	3:B:1069:PRO:HA	1.71	0.72
3:B:825:LYS:HD2	3:B:942:ALA:HA	1.72	0.71
1:G:62:GLN:HB2	1:G:68:PRO:HB3	1.73	0.71
3:B:102:ARG:HH22	3:B:179:LEU:HG	1.55	0.71
3:C:318:PHE:HD2	3:C:615:VAL:HG11	1.55	0.71
3:C:559:PHE:HB3	3:C:563:GLN:HB3	1.73	0.71
3:C:485:GLY:H	3:C:488:CYS:HB3	1.56	0.70
1:G:67:PRO:HB3	2:F:123:TRP:HB2	1.73	0.70
3:B:324:GLU:OE1	3:B:537:LYS:NZ	2.24	0.70
2:F:58:GLN:NE2	2:F:59:SER:O	2.25	0.70
1:L:211:GLN:HE22	2:H:221:GLN:HG3	1.55	0.69
2:H:58:GLN:NE2	2:H:61:GLU:O	2.25	0.69
3:B:812:PRO:HB2	3:B:815:ARG:HH21	1.56	0.69
3:A:560:LEU:HG	3:A:562:PHE:H	1.57	0.69
1:G:132:ARG:HD2	1:G:222:SER:HB2	1.74	0.69
3:A:560:LEU:HD12	3:A:561:PRO:HD2	1.75	0.69
3:C:707:TYR:HB3	3:A:792:PRO:HG3	1.74	0.69
2:H:25:GLN:O	2:H:125:GLN:NE2	2.26	0.69
3:C:376:THR:HB	3:C:435:ALA:HB3	1.74	0.69
2:F:43:ALA:HB1	2:F:46:TYR:HB2	1.75	0.68
1:E:113:GLN:NE2	1:E:114:GLN:O	2.26	0.68
1:E:56:LEU:HG	1:E:115:SER:HB2	1.75	0.68
1:L:100:HIS:HB2	1:L:101:PRO:HD3	1.76	0.68
3:C:128:ILE:HG21	3:C:229:LEU:HD21	1.75	0.68
3:B:323:THR:HG22	3:B:324:GLU:OE1	1.94	0.68

Continued on next page...

Continued from previous page...

Atom-1	Atom-2	Interatomic distance (Å)	Clash overlap (Å)
3:B:722:VAL:HG22	3:B:1065:VAL:HG22	1.76	0.68
3:C:448:ASN:HB3	3:C:497:PHE:HB2	1.75	0.67
3:B:1098:ASN:OD1	3:B:1101:HIS:N	2.28	0.67
3:C:193:VAL:HG23	3:C:223:LEU:HD22	1.76	0.67
3:B:499:PRO:HA	3:B:506:GLN:HG2	1.76	0.67
2:D:56:MET:HG3	2:D:66:TRP:HA	1.76	0.67
3:C:1094:VAL:HG13	3:C:1107:ARG:HG2	1.75	0.66
3:B:456:PHE:HZ	1:G:77:ASN:HD22	1.44	0.66
3:A:81:ASN:O	3:A:239:GLN:NE2	2.24	0.66
3:B:1053:PRO:O	3:B:1054:GLN:NE2	2.28	0.66
1:E:117:LYS:HG3	1:E:119:PRO:HD2	1.75	0.66
1:L:206:GLN:NE2	1:L:209:ASN:OD1	2.23	0.66
3:B:34:ARG:NH1	3:B:191:GLU:OE2	2.28	0.66
1:G:73:TYR:HB2	1:G:77:ASN:HB3	1.76	0.66
3:B:66:HIS:HB2	3:B:78:ARG:HH11	1.61	0.66
3:A:906:PHE:HB3	3:A:911:VAL:HG23	1.78	0.66
3:A:896:ILE:HD12	3:A:897:PRO:HD2	1.78	0.65
2:F:72:PRO:HB3	2:F:93:LYS:HE2	1.78	0.65
3:A:280:ASN:HD21	3:A:284:THR:HB	1.62	0.65
3:B:533:LEU:HB2	3:B:535:LYS:HZ1	1.60	0.65
1:G:38:ARG:NH1	1:G:98:ASN:OD1	2.28	0.65
3:A:355:ARG:HD3	3:A:357:ARG:HH21	1.62	0.65
3:A:123:ALA:HB2	3:A:179:LEU:HD21	1.79	0.65
1:L:113:GLN:NE2	1:L:114:GLN:O	2.30	0.65
3:C:239:GLN:NE2	3:C:240:THR:O	2.26	0.65
3:B:131:CYS:HA	3:B:166:CYS:HA	1.78	0.65
3:B:197:ILE:HB	3:B:202:LYS:HZ1	1.61	0.65
3:C:616:ASN:OD1	3:C:617:CYS:N	2.30	0.65
3:C:973:ILE:HG12	3:C:992:GLN:HG2	1.79	0.65
3:B:439:ASN:HB3	3:B:499:PRO:HG3	1.78	0.65
3:A:326:ILE:HD11	3:A:533:LEU:HA	1.78	0.65
2:H:112:VAL:HA	2:H:128:SER:HA	1.79	0.64
3:A:452:LEU:HD13	3:A:492:LEU:HD11	1.79	0.64
1:L:117:LYS:HG2	1:L:119:PRO:HD2	1.79	0.64
3:A:1080:ALA:HB3	3:A:1132:ILE:HG22	1.80	0.64
1:E:33:VAL:HA	1:E:37:GLN:HE21	1.62	0.64
3:C:796:ASP:OD2	4:Z:1:NAG:O6	2.14	0.64
2:F:38:LYS:HA	2:F:100:MET:O	1.98	0.64
1:L:164:PRO:HB2	1:L:187:LEU:HD12	1.80	0.64
3:A:133:PHE:CB	3:A:164:ASN:HD21	2.11	0.64
3:A:216:LEU:HD12	3:A:217:PRO:HD2	1.80	0.64

Continued on next page...

Continued from previous page...

Atom-1	Atom-2	Interatomic distance (Å)	Clash overlap (Å)
1:L:85:ARG:HB2	1:L:101:PRO:HD2	1.79	0.63
3:C:869:MET:HB3	3:B:699:LEU:HD11	1.79	0.63
2:F:176:PRO:HG2	2:F:263:PRO:HG3	1.81	0.63
2:D:25:GLN:HG2	2:D:127:THR:HG23	1.81	0.63
3:C:659:SER:HB3	3:C:698:SER:HB3	1.81	0.63
3:B:310:LYS:HG3	3:B:600:PRO:HA	1.81	0.63
1:E:62:GLN:NE2	1:E:63:LYS:O	2.32	0.63
1:L:164:PRO:HB3	1:L:190:PHE:HB3	1.79	0.63
3:B:395:VAL:HG13	3:B:513:LEU:HD11	1.81	0.63
3:C:1053:PRO:O	3:C:1054:GLN:NE2	2.32	0.63
3:B:523:THR:HG23	3:B:524:VAL:HG13	1.81	0.63
1:G:211:GLN:HB2	2:F:219:VAL:HG21	1.81	0.63
1:G:55:SER:HB2	1:G:75:ALA:HB2	1.81	0.62
2:H:117:ARG:HE	2:H:121:ASP:HB3	1.65	0.62
3:C:457:ARG:NH1	3:C:459:SER:O	2.32	0.62
3:C:194:PHE:HD1	3:C:203:ILE:HG12	1.64	0.62
3:C:107:GLY:H	3:C:235:ILE:HG23	1.64	0.62
1:L:195:ALA:HB2	1:L:249:HIS:HD2	1.64	0.62
3:A:365:TYR:HD2	3:A:387:LEU:HB3	1.64	0.62
3:A:472:ILE:HG13	3:A:490:PHE:HD1	1.63	0.62
1:G:129:GLU:OE2	1:G:193:ARG:NH2	2.33	0.62
2:F:259:LYS:NZ	2:F:260:LYS:O	2.32	0.62
1:L:196:LYS:HB3	1:L:248:THR:HG22	1.81	0.62
3:C:108:THR:O	3:C:237:ARG:NH1	2.31	0.62
1:L:187:LEU:HD23	1:L:226:LEU:HD22	1.81	0.62
3:B:133:PHE:CE2	3:B:135:PHE:HA	2.35	0.62
3:C:231:ILE:HG22	3:C:232:GLY:H	1.65	0.61
3:C:535:LYS:O	3:C:537:LYS:N	2.33	0.61
3:A:244:LEU:HD22	3:A:246:ARG:HG3	1.81	0.61
3:A:256:SER:HA	3:A:258:TRP:CZ3	2.35	0.61
3:A:278:LYS:HE2	3:A:287:ASP:HB2	1.82	0.61
3:C:34:ARG:NH2	3:C:218:GLN:O	2.33	0.61
1:L:169:PHE:HB2	1:L:184:VAL:HB	1.82	0.61
3:B:404:GLY:HA2	3:B:508:TYR:HE1	1.65	0.61
3:B:118:LEU:HD11	3:B:133:PHE:CE1	2.34	0.61
2:H:43:ALA:HB1	2:H:46:TYR:HB2	1.82	0.61
3:B:416:GLY:H	3:B:419:ALA:HB3	1.65	0.61
3:B:788:ILE:HG23	3:B:876:ALA:HB2	1.83	0.61
1:L:182:SER:HA	1:L:230:LEU:O	2.01	0.61
3:B:18:LEU:HD22	3:B:258:TRP:HE1	1.66	0.61
1:G:37:GLN:NE2	1:G:38:ARG:O	2.34	0.61

Continued on next page...

Continued from previous page...

Atom-1	Atom-2	Interatomic distance (Å)	Clash overlap (Å)
3:A:131:CYS:HB3	3:A:164:ASN:HD22	1.65	0.60
1:E:61:GLN:HB3	1:E:71:LEU:HD11	1.82	0.60
1:E:71:LEU:HB3	1:E:72:ILE:HD12	1.83	0.60
1:L:132:ARG:NH1	1:L:160:THR:OG1	2.33	0.60
3:B:69:HIS:CD2	3:B:259:THR:HA	2.36	0.60
3:B:1134:ASN:HB2	4:V:1:NAG:H2	1.82	0.60
3:C:395:VAL:HG23	3:C:524:VAL:HG21	1.84	0.60
3:B:119:ILE:HG23	3:B:128:ILE:HG12	1.83	0.60
3:A:206:LYS:NZ	3:A:207:HIS:O	2.34	0.60
3:B:607:GLN:NE2	3:B:690:GLN:O	2.35	0.60
3:A:534:VAL:HG12	3:A:535:LYS:H	1.66	0.60
1:G:241:LYS:HE3	1:G:262:ARG:HH21	1.65	0.60
1:L:241:LYS:HD2	1:L:262:ARG:HB2	1.83	0.60
3:C:825:LYS:NZ	3:C:939:SER:O	2.32	0.60
2:H:119:ARG:NH2	3:C:484:GLU:OE2	2.35	0.60
3:B:656:VAL:HG22	3:B:658:ASN:H	1.67	0.60
3:C:788:ILE:HG23	3:C:876:ALA:HB2	1.82	0.59
3:B:66:HIS:HB3	3:B:68:ILE:HG12	1.84	0.59
3:B:328:ARG:NH1	3:B:531:THR:O	2.28	0.59
3:C:866:THR:HG22	3:C:869:MET:HG3	1.85	0.59
3:C:1104:VAL:HG23	3:C:1115:ILE:HG12	1.84	0.59
3:B:472:ILE:HG22	3:B:491:PRO:HD3	1.84	0.59
1:L:27:SER:OG	1:L:42:SER:HB3	2.03	0.59
1:L:73:TYR:N	1:L:77:ASN:O	2.33	0.59
3:C:145:TYR:HB3	3:C:247:SER:HA	1.85	0.59
2:F:70:ILE:HD12	2:F:91:VAL:HG12	1.84	0.59
3:B:308:VAL:HG22	3:B:602:THR:HG23	1.84	0.58
3:B:729:VAL:HG22	3:B:1059:GLY:HA2	1.85	0.58
1:L:192:PRO:O	1:L:249:HIS:NE2	2.30	0.58
3:C:131:CYS:HB2	3:C:133:PHE:HD1	1.68	0.58
2:F:67:ILE:HA	2:F:83:PHE:HZ	1.68	0.58
2:H:209:LEU:HD21	2:H:232:VAL:HG21	1.86	0.58
3:C:1010[A]:GLN:HE21	3:C:1011:GLN:HG2	1.67	0.58
3:B:244:LEU:HD11	3:B:258:TRP:HA	1.84	0.58
1:G:132:ARG:NH1	1:G:160:THR:O	2.36	0.58
3:A:328:ARG:HB2	3:A:543:PHE:HA	1.84	0.58
1:L:83:PRO:HB3	1:L:85:ARG:NH1	2.18	0.58
3:C:328:ARG:HG3	3:C:543:PHE:HE1	1.69	0.58
3:C:763:LEU:HD22	3:C:1008:VAL:HG21	1.85	0.58
3:B:102:ARG:HH12	3:B:179:LEU:HD11	1.66	0.58
3:B:201:PHE:HZ	3:B:235:ILE:HG13	1.68	0.58

Continued on next page...

Continued from previous page...

Atom-1	Atom-2	Interatomic distance (Å)	Clash overlap (Å)
1:G:68:PRO:O	2:F:123:TRP:NE1	2.36	0.58
3:C:394:ASN:C	3:C:394:ASN:HD22	2.07	0.58
2:F:42:LYS:HA	2:F:97:THR:HG22	1.84	0.58
1:L:113:GLN:HE21	1:L:120:TRP:HB3	1.69	0.58
3:C:722:VAL:HG22	3:C:1065:VAL:HG22	1.85	0.58
3:B:452:LEU:HB3	3:B:492:LEU:HD13	1.85	0.58
1:G:48:SER:O	1:G:116:ARG:NH1	2.37	0.58
3:B:788:ILE:HD11	3:A:699:LEU:HB2	1.84	0.58
1:L:72:ILE:HG22	1:L:74:ALA:H	1.69	0.57
1:L:171:PRO:HB3	1:L:182:SER:H	1.70	0.57
3:C:278:LYS:NZ	3:C:286:THR:OG1	2.36	0.57
3:B:119:ILE:HG12	3:B:128:ILE:HG23	1.85	0.57
3:B:273:ARG:HH11	3:B:292:ALA:HB3	1.69	0.57
1:G:47:GLU:HB2	1:G:116:ARG:HH12	1.68	0.57
1:G:195:ALA:HB2	1:G:249:HIS:HD2	1.69	0.57
3:A:598:ILE:HB	3:A:609:ALA:HB3	1.86	0.57
1:L:29:ALA:HA	1:L:126:THR:HG22	1.86	0.57
3:C:667:GLY:HA2	3:A:864:LEU:HD12	1.85	0.57
3:B:52:GLN:HB3	3:B:274:THR:HG22	1.86	0.57
3:B:903:ALA:HB1	3:B:913:GLN:HB2	1.85	0.57
3:B:1104:VAL:HG23	3:B:1115:ILE:HG13	1.86	0.57
2:H:66:TRP:O	2:H:80:ASN:ND2	2.38	0.57
3:C:317:ASN:HA	3:C:594:GLY:HA2	1.87	0.57
3:C:1123:SER:OG	3:A:918:GLU:OE2	2.22	0.57
3:A:331:ASN:HA	3:A:528:LYS:HE2	1.86	0.57
3:A:455:LEU:HB2	3:A:491:PRO:HB3	1.86	0.57
1:E:62:GLN:NE2	1:E:66:GLN:O	2.28	0.57
1:G:132:ARG:HH12	1:G:162:ALA:HB2	1.69	0.57
3:A:52:GLN:HB2	3:A:274:THR:HG22	1.87	0.57
2:H:219:VAL:O	2:H:221:GLN:NE2	2.38	0.57
2:H:243:THR:HG23	2:H:260:LYS:HE2	1.85	0.57
2:F:209:LEU:HD21	2:F:232:VAL:HG21	1.86	0.57
3:A:131:CYS:HB3	3:A:164:ASN:HB2	1.87	0.57
3:C:906:PHE:HB3	3:C:911:VAL:HG23	1.86	0.57
3:B:453:TYR:HD1	3:B:495:TYR:HB2	1.70	0.57
3:A:489:TYR:OH	1:E:58:GLN:NE2	2.38	0.57
2:D:55:TRP:CE2	2:D:100:MET:HB2	2.39	0.57
3:C:1010[A]:GLN:OE1	3:C:1014:ARG:NH2	2.38	0.56
1:E:73:TYR:HB2	1:E:77:ASN:HB2	1.87	0.56
1:L:201:VAL:HG13	1:L:243:TYR:HE1	1.69	0.56
3:B:328:ARG:CZ	3:B:580:GLN:HG3	2.34	0.56

Continued on next page...

Continued from previous page...

Atom-1	Atom-2	Interatomic distance (Å)	Clash overlap (Å)
3:C:119:ILE:HG13	3:C:128:ILE:HG23	1.86	0.56
3:A:231:ILE:HG13	3:A:232:GLY:H	1.70	0.56
3:A:485:GLY:H	3:A:488:CYS:HB2	1.70	0.56
1:L:192:PRO:HD2	1:L:249:HIS:HE1	1.70	0.56
3:C:434:ILE:HB	3:C:511:VAL:HG22	1.86	0.56
1:L:24:LEU:HA	1:L:44:ARG:O	2.05	0.56
3:B:1094:VAL:HG23	3:B:1096:VAL:HG13	1.87	0.56
3:B:1097:SER:HB2	3:B:1102:TRP:CD2	2.40	0.56
3:B:501:ASN:HB3	3:B:505:TYR:HB2	1.87	0.56
3:C:18:LEU:HD13	3:C:244:LEU:HD13	1.86	0.56
2:D:24:GLN:HB2	2:D:42:LYS:HG2	1.88	0.56
2:H:34:GLY:H	2:H:105:LEU:HB2	1.70	0.56
3:C:699:LEU:HB3	3:A:873:TYR:HE1	1.71	0.56
3:B:1125:ASN:ND2	3:B:1127:ASP:OD2	2.39	0.56
3:A:1106:GLN:HE21	3:A:1109:PHE:HB3	1.71	0.56
3:C:213:VAL:HG23	3:C:214:ARG:H	1.72	0.55
3:B:598:ILE:HG23	3:B:664:ILE:HG21	1.87	0.55
3:A:903:ALA:HB1	3:A:913:GLN:HG3	1.87	0.55
3:A:1010[A]:GLN:OE1	3:A:1014:ARG:NH1	2.39	0.55
3:B:736:VAL:HG21	3:B:1004:LEU:HD11	1.89	0.55
3:A:495:TYR:HB2	3:A:497:PHE:CE1	2.41	0.55
3:A:497:PHE:CE2	3:A:507:PRO:HB3	2.38	0.55
2:H:29:GLU:O	2:H:130:THR:OG1	2.24	0.55
3:C:106:PHE:HB3	3:C:235:ILE:HG12	1.89	0.55
3:B:540:ASN:ND2	3:B:548:GLY:O	2.39	0.55
3:C:69:HIS:HA	3:C:77:LYS:HA	1.89	0.55
3:C:277:LEU:HD23	3:C:285:ILE:HD13	1.89	0.55
3:C:560:LEU:HB2	3:C:563:GLN:HB2	1.88	0.55
3:B:930:ALA:O	3:B:934:ILE:HG12	2.06	0.55
3:C:365:TYR:HD1	3:C:368:LEU:HD12	1.71	0.55
1:E:61:GLN:O	1:E:69:LYS:N	2.39	0.55
1:L:199:TRP:CZ3	1:L:230:LEU:HB2	2.42	0.55
1:G:190:PHE:O	1:G:224:TYR:N	2.36	0.55
2:D:57:LYS:HG2	2:D:113:TYR:CD1	2.39	0.55
2:D:74:THR:HG23	2:D:76:GLY:H	1.72	0.55
1:L:171:PRO:HG3	1:L:181:ALA:HB1	1.89	0.54
3:C:598:ILE:HB	3:C:609:ALA:HB3	1.89	0.54
3:A:490:PHE:HE2	3:A:492:LEU:HD23	1.72	0.54
2:H:234:VAL:HG11	2:H:244:TYR:HE2	1.72	0.54
3:B:99:ASN:O	3:B:102:ARG:NH2	2.40	0.54
3:A:130:VAL:HG12	3:A:168:PHE:HA	1.88	0.54

Continued on next page...

Continued from previous page...

Atom-1	Atom-2	Interatomic distance (Å)	Clash overlap (Å)
3:A:568:ASP:OD1	3:A:572:THR:OG1	2.25	0.54
1:E:38:ARG:HG3	1:E:100:HIS:HA	1.90	0.54
3:C:106:PHE:HB2	3:C:117:LEU:HB2	1.89	0.54
1:G:58:GLN:HB3	1:G:60:TYR:HE1	1.72	0.54
3:A:472:ILE:HG21	3:A:484:GLU:HB3	1.90	0.54
3:C:473:TYR:O	3:C:475:ALA:N	2.40	0.54
3:C:1086:LYS:HE3	3:C:1122:VAL:HG21	1.89	0.54
1:G:58:GLN:HB2	1:G:113:GLN:HB3	1.89	0.54
2:F:57:LYS:HB2	2:F:67:ILE:HD11	1.89	0.54
1:L:191:TYR:HB3	1:L:192:PRO:HD3	1.90	0.54
1:E:68:PRO:O	2:D:123:TRP:NE1	2.40	0.54
3:C:220:PHE:HE2	3:C:285:ILE:HG22	1.73	0.54
3:C:52:GLN:HB2	3:C:274:THR:HG22	1.89	0.54
3:A:84:LEU:HD22	3:A:267:VAL:HG11	1.89	0.54
2:D:119:ARG:H	2:D:119:ARG:HD3	1.72	0.54
2:H:72:PRO:O	2:H:93:LYS:NZ	2.33	0.54
2:H:50:GLY:HA2	3:C:483:VAL:HA	1.90	0.53
3:B:347:PHE:CE1	3:B:399:SER:HB2	2.43	0.53
3:C:229:LEU:O	3:C:231:ILE:HG12	2.09	0.53
3:B:347:PHE:CE2	3:B:401:VAL:HG13	2.42	0.53
2:F:87:ALA:HA	2:F:102:LEU:HA	1.90	0.53
3:C:280:ASN:OD1	3:C:284:THR:N	2.42	0.53
3:C:393:THR:HA	3:C:522:ALA:HA	1.91	0.53
3:A:985:ASP:N	3:A:988:GLU:OE2	2.42	0.53
1:L:195:ALA:HB2	1:L:249:HIS:CD2	2.44	0.53
3:B:546:LEU:HD21	3:B:573:THR:HG21	1.90	0.53
3:C:406:GLU:O	3:C:409:GLN:HG2	2.09	0.53
3:A:82:PRO:HG2	3:A:84:LEU:HD11	1.91	0.53
1:G:47:GLU:H	1:G:116:ARG:HH22	1.57	0.53
3:A:89:GLY:HA2	3:A:194:PHE:O	2.09	0.53
2:H:46:TYR:CE1	2:H:117:ARG:HD3	2.43	0.53
1:G:164:PRO:HB2	1:G:187:LEU:HD22	1.90	0.53
3:A:418:ILE:HA	3:A:422:ASN:HB2	1.90	0.53
2:H:191:LEU:HG	2:H:193:LYS:HG3	1.90	0.53
2:F:38:LYS:HB3	2:F:101:GLN:HG2	1.91	0.53
3:B:347:PHE:CZ	3:B:399:SER:HB2	2.44	0.52
3:A:377:PHE:HE1	3:A:434:ILE:HG23	1.74	0.52
3:A:483:VAL:HG12	2:D:50:GLY:HA2	1.91	0.52
2:H:116:ALA:HB1	2:H:120:GLY:HA2	1.90	0.52
3:C:18:LEU:HB3	3:C:258:TRP:CZ2	2.44	0.52
3:C:906:PHE:CD2	3:C:916:LEU:HB2	2.44	0.52

Continued on next page...

Continued from previous page...

Atom-1	Atom-2	Interatomic distance (Å)	Clash overlap (Å)
3:B:245:HIS:O	3:B:259:THR:OG1	2.27	0.52
1:L:241:LYS:HZ2	1:L:261:ASN:HB3	1.75	0.52
2:H:56:MET:HB2	2:H:114:TYR:HB2	1.90	0.52
3:C:65:PHE:CD1	3:C:80:ASP:HB3	2.44	0.52
3:C:528:LYS:O	3:C:529:LYS:HG2	2.09	0.52
3:B:453:TYR:CD1	3:B:495:TYR:HB2	2.45	0.52
3:B:556:ASN:OD1	3:B:557:LYS:N	2.43	0.52
3:A:454:ARG:HD3	3:A:491:PRO:O	2.10	0.52
3:C:1145:LEU:HD21	3:B:1145:LEU:HD21	1.92	0.52
3:B:280:ASN:HD21	3:B:284:THR:HB	1.74	0.52
3:B:873:TYR:CE1	3:A:699:LEU:HB3	2.44	0.52
1:G:63:LYS:NZ	1:G:105:ASP:O	2.39	0.52
2:H:205:ASN:HD22	2:H:209:LEU:HB2	1.75	0.52
3:C:404:GLY:HA2	3:C:508:TYR:HB2	1.91	0.52
3:C:1079:PRO:HB3	3:A:917:TYR:CE1	2.44	0.52
3:B:901:GLN:HE21	3:B:905:ARG:HE	1.58	0.52
3:A:659:SER:HB3	3:A:698:SER:HB2	1.91	0.52
3:B:440:ASN:OD1	3:B:441:LEU:N	2.43	0.52
2:D:38:LYS:HG2	2:D:101:GLN:HB2	1.92	0.52
3:C:110:LEU:HD23	3:C:135:PHE:HZ	1.74	0.52
3:C:244:LEU:HD23	3:C:246:ARG:HE	1.75	0.52
3:A:18:LEU:HB3	3:A:258:TRP:CZ2	2.45	0.52
3:A:131:CYS:CB	3:A:164:ASN:HD22	2.21	0.52
3:A:521:PRO:HA	3:A:564:GLN:HE21	1.74	0.52
1:L:110:TYR:HB2	1:L:126:THR:OG1	2.09	0.52
3:C:412:PRO:O	3:C:414:GLN:NE2	2.43	0.52
3:A:77:LYS:HZ1	3:A:258:TRP:HB2	1.75	0.52
3:A:501:ASN:O	3:A:506:GLN:NE2	2.43	0.52
3:A:1104:VAL:HG23	3:A:1115:ILE:HG12	1.91	0.52
3:C:906:PHE:HA	3:C:909:ILE:HG12	1.90	0.51
3:B:24:LEU:HD12	3:B:78:ARG:HD2	1.91	0.51
3:B:118:LEU:HD11	3:B:133:PHE:CD1	2.45	0.51
3:B:342:PHE:HB3	3:B:374:PHE:CZ	2.45	0.51
3:B:555:SER:HB2	3:B:586:ASP:HB2	1.91	0.51
3:B:1086:LYS:HB2	3:B:1088:HIS:NE2	2.25	0.51
4:R:1:NAG:H4	4:R:2:NAG:N2	2.25	0.51
3:B:917:TYR:HB3	3:A:1129:VAL:HG13	1.90	0.51
3:A:1074:ASN:OD1	5:A:1307:NAG:N2	2.43	0.51
1:L:186:LEU:HD11	2:H:231:VAL:HG21	1.91	0.51
3:B:1095:PHE:CE1	3:B:1104:VAL:HG22	2.46	0.51
1:G:120:TRP:HB2	2:F:66:TRP:CE3	2.45	0.51

Continued on next page...

Continued from previous page...

Atom-1	Atom-2	Interatomic distance (Å)	Clash overlap (Å)
3:A:457:ARG:HG2	3:A:458:LYS:H	1.74	0.51
1:E:68:PRO:HG2	2:D:123:TRP:CE2	2.45	0.51
3:B:904:TYR:OH	3:A:1094:VAL:HG12	2.09	0.51
3:A:210:ILE:HG12	3:A:217:PRO:HG3	1.92	0.51
3:B:1006:THR:O	3:B:1010[B]:GLN:HG2	2.10	0.51
1:G:49:VAL:HA	1:G:116:ARG:HD3	1.92	0.51
3:A:158:ARG:HH21	3:A:246:ARG:HH12	1.58	0.51
3:A:326:ILE:HD12	3:A:534:VAL:HG23	1.92	0.51
1:E:73:TYR:HE1	1:E:79:GLU:HA	1.76	0.51
3:B:379:CYS:HB3	3:B:433:VAL:O	2.11	0.51
3:B:577:ARG:HH21	3:B:584:ILE:HD11	1.75	0.51
2:F:187:ALA:HB2	2:F:233:THR:HG22	1.92	0.51
2:F:204:TRP:HB3	2:F:209:LEU:HB3	1.91	0.51
3:A:117:LEU:HD21	3:A:231:ILE:HD13	1.93	0.51
1:L:32:ALA:HB1	1:L:131:LYS:HD2	1.93	0.51
1:G:59:TRP:HZ2	1:G:95:PHE:HB3	1.76	0.51
1:G:89:SER:OG	1:G:90:GLY:N	2.44	0.51
3:C:24:LEU:O	3:C:78:ARG:NH2	2.44	0.50
3:A:18:LEU:HD13	3:A:258:TRP:HE1	1.75	0.50
2:H:81:GLN:HA	2:H:84:LYS:HB2	1.92	0.50
3:C:132:GLU:O	3:C:134:GLN:NE2	2.36	0.50
3:C:502:GLY:O	3:C:504:GLY:N	2.45	0.50
3:C:521:PRO:HB3	3:A:200:TYR:CE1	2.46	0.50
3:B:342:PHE:CD2	3:B:511:VAL:HG11	2.46	0.50
3:C:665:PRO:HA	3:C:671:CYS:SG	2.52	0.50
3:C:1094:VAL:HG12	3:A:904:TYR:OH	2.12	0.50
3:B:69:HIS:HD2	3:B:259:THR:HA	1.75	0.50
3:B:431:GLY:HA3	3:B:514:SER:HA	1.93	0.50
3:A:159:VAL:HG12	3:A:160:TYR:N	2.27	0.50
3:A:501:ASN:HB3	3:A:505:TYR:HB2	1.93	0.50
2:D:25:GLN:O	2:D:125:GLN:NE2	2.44	0.50
3:C:210:ILE:HG21	3:C:217:PRO:HG3	1.92	0.50
3:C:374:PHE:HB3	3:C:436:TRP:HE3	1.77	0.50
3:C:1103:PHE:HB3	3:C:1112:PRO:O	2.11	0.50
1:G:22:ILE:HG12	1:G:117:LYS:HB3	1.92	0.50
1:E:85:ARG:HG2	1:E:101:PRO:HG2	1.92	0.50
2:D:23:LEU:HD12	2:D:46:TYR:HE2	1.76	0.50
3:C:873:TYR:CZ	3:B:699:LEU:HD22	2.45	0.50
3:A:578:ASP:OD1	3:A:578:ASP:N	2.45	0.50
3:C:767:LEU:HD11	3:C:1008:VAL:HG22	1.93	0.50
2:F:56:MET:HG3	2:F:66:TRP:HA	1.94	0.50

Continued on next page...

Continued from previous page...

Atom-1	Atom-2	Interatomic distance (Å)	Clash overlap (Å)
2:F:193:LYS:HD3	2:F:227:SER:HB2	1.93	0.50
3:C:904:TYR:OH	3:B:1094:VAL:HG12	2.11	0.50
3:B:16:VAL:HG21	3:B:254:SER:HB2	1.93	0.50
3:B:484:GLU:N	2:F:50:GLY:O	2.36	0.50
2:F:79:ASP:HB3	2:F:84:LYS:HD3	1.94	0.50
3:A:411:ALA:HB3	3:A:414:GLN:HG3	1.92	0.50
3:C:97:LYS:HB3	3:C:186:PHE:HA	1.94	0.50
3:C:377:PHE:HD1	3:C:434:ILE:HD13	1.77	0.50
3:C:811:LYS:HD2	3:C:813:SER:O	2.12	0.50
3:A:133:PHE:HB3	3:A:164:ASN:ND2	2.23	0.50
3:A:642:VAL:HG12	3:A:651:ILE:HG12	1.94	0.50
2:H:25:GLN:OE1	2:H:127:THR:N	2.45	0.49
3:C:329:PHE:N	3:C:530:SER:OG	2.43	0.49
1:G:27:SER:OG	1:G:42:SER:HB3	2.12	0.49
2:F:79:ASP:OD1	2:F:80:ASN:N	2.44	0.49
3:B:461:LEU:HD13	3:B:465:GLU:HG3	1.94	0.49
3:A:528:LYS:O	3:A:528:LYS:HG2	2.11	0.49
1:L:22:ILE:HG23	1:L:46:SER:H	1.76	0.49
1:E:27:SER:OG	1:E:42:SER:HB3	2.13	0.49
1:L:132:ARG:HD2	1:L:222:SER:HB2	1.93	0.49
3:C:451:TYR:HB2	3:C:495:TYR:CE2	2.48	0.49
3:C:475:ALA:HB1	3:C:487:ASN:HB3	1.94	0.49
3:B:102:ARG:NH2	3:B:179:LEU:HG	2.27	0.49
1:G:113:GLN:HG2	1:G:114:GLN:H	1.78	0.49
3:A:474:GLN:OE1	3:A:480:CYS:N	2.42	0.49
2:H:71:ASN:O	2:H:75:GLY:N	2.45	0.49
3:C:979:ASP:HB3	3:C:983:ARG:NH1	2.27	0.49
3:B:472:ILE:HG22	3:B:490:PHE:HA	1.95	0.49
1:L:41:ILE:HD11	1:L:97:LEU:HD12	1.94	0.49
3:C:96:GLU:OE2	3:C:101:ILE:N	2.38	0.49
3:C:131:CYS:HB2	3:C:133:PHE:CD1	2.48	0.49
3:C:157:PHE:CE2	3:C:159:VAL:HG23	2.47	0.49
3:C:817:PHE:O	3:C:821:LEU:HG	2.13	0.49
3:A:18:LEU:HB3	3:A:258:TRP:HZ2	1.78	0.49
3:A:328:ARG:HH21	3:A:578:ASP:HB2	1.76	0.49
3:C:618:THR:OG1	5:C:1302:NAG:O7	2.29	0.49
3:B:69:HIS:CD2	3:B:77:LYS:HE2	2.47	0.49
3:B:611:LEU:HD22	3:B:666:ILE:HG23	1.95	0.49
3:A:715:PRO:HA	3:A:1072:GLU:HA	1.95	0.49
3:C:326:ILE:HD12	3:C:539:VAL:HG21	1.94	0.49
3:C:360:ASN:HA	3:C:523:THR:HB	1.95	0.49

Continued on next page...

Continued from previous page...

Atom-1	Atom-2	Interatomic distance (Å)	Clash overlap (Å)
1:E:59:TRP:CZ3	1:E:97:LEU:HB2	2.48	0.49
3:B:388:ASN:HA	3:B:526:GLY:HA3	1.95	0.49
3:B:439:ASN:ND2	3:B:507:PRO:O	2.40	0.49
3:B:731:MET:HE2	3:B:1018:ILE:HG13	1.95	0.49
3:B:1097:SER:HB2	3:B:1102:TRP:CE3	2.48	0.49
1:G:58:GLN:NE2	1:G:115:SER:OG	2.45	0.49
3:A:1086:LYS:HB3	3:A:1122:VAL:HG13	1.95	0.49
1:E:100:HIS:HB2	1:E:101:PRO:HD3	1.94	0.49
2:D:26:SER:O	2:D:40:SER:OG	2.31	0.49
2:D:55:TRP:NE1	2:D:100:MET:HB2	2.28	0.49
2:H:40:SER:HB3	2:H:99:TYR:HE1	1.78	0.48
2:H:54:ASN:ND2	2:H:118:SER:O	2.46	0.48
3:C:69:HIS:HB2	3:C:77:LYS:HG2	1.95	0.48
3:C:994:ASP:HA	3:C:997:ILE:HB	1.95	0.48
1:G:73:TYR:CE1	1:G:79:GLU:HA	2.48	0.48
1:L:87:SER:OG	1:L:98:ASN:O	2.26	0.48
2:H:67:ILE:HD13	2:H:100:MET:HE1	1.95	0.48
3:B:597:VAL:HG13	3:B:608:VAL:HG23	1.95	0.48
3:B:1094:VAL:HG13	3:B:1107:ARG:HG2	1.94	0.48
3:A:190:ARG:HB3	3:A:192:PHE:HE1	1.78	0.48
2:F:58:GLN:NE2	2:F:61:GLU:O	2.39	0.48
3:A:472:ILE:HG22	3:A:488:CYS:HB3	1.95	0.48
3:C:69:HIS:HB3	3:C:260:ALA:HB3	1.95	0.48
3:B:380:TYR:H	3:B:432:CYS:HB2	1.78	0.48
3:B:945:LEU:HD23	3:B:948:LEU:HD12	1.93	0.48
3:C:342:PHE:CE1	3:C:511:VAL:HG21	2.48	0.48
3:B:436:TRP:CZ3	3:B:509:ARG:HD2	2.47	0.48
3:B:805:ILE:HD12	3:B:878:LEU:HD11	1.94	0.48
1:E:60:TYR:CD1	1:E:70:VAL:HG22	2.48	0.48
3:C:660:TYR:HB2	3:C:695:TYR:CZ	2.49	0.48
3:C:924:ALA:O	3:C:928:ASN:ND2	2.45	0.48
1:G:165:SER:HB3	1:G:188:ASN:HB2	1.94	0.48
3:A:1116:THR:HG22	3:A:1138:TYR:HB3	1.95	0.48
1:G:60:TYR:CE2	1:G:70:VAL:HG22	2.49	0.48
3:A:231:ILE:HG13	3:A:232:GLY:N	2.29	0.48
3:C:1092:GLU:O	3:C:1107:ARG:NH1	2.47	0.48
3:A:486:PHE:HE1	2:D:119:ARG:HA	1.78	0.48
1:E:32:ALA:HB1	1:E:131:LYS:HB2	1.95	0.48
1:L:192:PRO:HD2	1:L:249:HIS:CE1	2.48	0.48
3:B:461:LEU:HB3	3:B:465:GLU:HB3	1.94	0.48
3:B:591:SER:HB3	3:B:615:VAL:HG22	1.94	0.48

Continued on next page...

Continued from previous page...

Atom-1	Atom-2	Interatomic distance (Å)	Clash overlap (Å)
3:B:733:LYS:NZ	3:B:775:ASP:OD2	2.46	0.48
1:G:187:LEU:HD21	1:G:247:VAL:HG21	1.96	0.48
1:E:22:ILE:HG12	1:E:47:GLU:HG3	1.96	0.48
1:L:38:ARG:HD3	1:L:39:ALA:H	1.79	0.48
2:H:77:THR:HG21	2:H:89:LEU:HB2	1.95	0.48
3:A:896:ILE:HD11	3:A:900:MET:HB2	1.95	0.48
3:C:69:HIS:ND1	3:C:260:ALA:O	2.37	0.47
3:C:434:ILE:O	3:C:510:VAL:HG23	2.14	0.47
3:C:970:PHE:O	3:C:995:ARG:NH1	2.47	0.47
3:A:79:PHE:CE1	3:A:242:LEU:HD23	2.49	0.47
1:E:94:ASP:OD1	1:E:95:PHE:N	2.47	0.47
3:C:645:THR:OG1	3:C:648:GLY:O	2.24	0.47
3:B:194:PHE:HE1	3:B:203:ILE:HG23	1.79	0.47
3:B:327:VAL:H	3:B:531:THR:HB	1.78	0.47
3:B:347:PHE:CD2	3:B:401:VAL:HG13	2.49	0.47
1:G:193:ARG:HB3	1:G:224:TYR:HE2	1.78	0.47
3:A:401:VAL:HG21	3:A:451:TYR:CG	2.49	0.47
3:A:448:ASN:O	3:A:497:PHE:HB2	2.15	0.47
2:H:196:PHE:CE1	2:H:197:PRO:HG3	2.50	0.47
3:B:802:PHE:HD1	3:B:805:ILE:HD11	1.79	0.47
2:D:59:SER:O	2:D:61:GLU:N	2.41	0.47
3:C:475:ALA:HA	3:C:488:CYS:HA	1.97	0.47
3:C:979:ASP:HB3	3:C:983:ARG:HH12	1.80	0.47
3:C:995:ARG:NH2	3:A:994:ASP:OD2	2.47	0.47
3:B:106:PHE:HB3	3:B:235:ILE:HD12	1.96	0.47
3:B:327:VAL:HG11	3:B:529:LYS:HB2	1.95	0.47
1:G:116:ARG:HG3	1:G:117:LYS:H	1.79	0.47
3:A:335:LEU:HD12	3:A:362:VAL:HG13	1.95	0.47
3:A:534:VAL:HG12	3:A:535:LYS:N	2.28	0.47
1:L:225:SER:HG	2:H:216:PHE:HZ	1.60	0.47
3:C:142:GLY:HA2	3:C:244:LEU:H	1.79	0.47
3:B:21:ARG:NE	3:B:79:PHE:O	2.47	0.47
1:G:40:THR:OG1	1:G:96:SER:OG	2.26	0.47
1:G:200:LYS:HB2	1:G:203:ASN:HA	1.97	0.47
3:A:425:LEU:HD12	3:A:426:PRO:HD2	1.96	0.47
1:L:189:ASN:OD1	1:L:223:THR:OG1	2.31	0.47
2:H:201:THR:OG1	2:H:249:ASN:HB2	2.15	0.47
3:C:880:GLY:O	3:C:884:SER:OG	2.18	0.47
2:H:39:ILE:O	2:H:99:TYR:HA	2.15	0.47
2:H:59:SER:OG	2:H:63:SER:HB3	2.15	0.47
3:C:365:TYR:HA	3:C:368:LEU:HD12	1.96	0.47

Continued on next page...

Continued from previous page...

Atom-1	Atom-2	Interatomic distance (Å)	Clash overlap (Å)
3:C:397:ALA:HA	3:C:512:VAL:O	2.14	0.47
3:C:506:GLN:CG	3:C:507:PRO:HD2	2.44	0.47
3:C:1007:TYR:O	3:C:1010[A]:GLN:HG3	2.14	0.47
3:C:1089:PHE:CE1	3:C:1123:SER:HB3	2.50	0.47
3:B:374:PHE:CD2	3:B:436:TRP:HB2	2.50	0.47
3:B:477:SER:HG	1:G:52:TYR:HH	1.63	0.47
3:B:976:VAL:HG12	3:B:979:ASP:H	1.80	0.47
3:B:1030:SER:HB3	3:A:1041:ASP:HB2	1.95	0.47
2:F:116:ALA:HB1	2:F:120:GLY:HA2	1.97	0.47
2:F:243:THR:HG23	2:F:260:LYS:NZ	2.30	0.47
3:A:1083:HIS:CD2	3:A:1136:THR:HA	2.50	0.47
3:C:1102:TRP:HB2	3:C:1135:ASN:ND2	2.30	0.47
3:A:811:LYS:HD3	3:A:814:LYS:NZ	2.30	0.47
3:C:20:THR:HG22	3:C:20:THR:O	2.15	0.47
3:B:1051:SER:OG	3:B:1064:HIS:ND1	2.41	0.47
4:O:2:NAG:O7	4:O:2:NAG:O4	2.23	0.47
3:C:118:LEU:HG	3:C:120:VAL:HG23	1.97	0.46
3:C:152:TRP:CD2	3:C:180:GLU:HA	2.50	0.46
1:G:49:VAL:HG22	1:G:92:GLY:O	2.15	0.46
3:A:240:THR:HG21	3:A:265:TYR:CZ	2.51	0.46
2:D:34:GLY:N	2:D:105:LEU:O	2.44	0.46
2:D:120:GLY:O	2:D:123:TRP:NE1	2.47	0.46
3:C:96:GLU:HB3	3:C:98:SER:O	2.15	0.46
3:A:974:SER:H	3:A:980:ILE:HD11	1.80	0.46
2:D:46:TYR:CE2	2:D:117:ARG:HD2	2.50	0.46
3:C:312:ILE:HG12	3:C:598:ILE:CD1	2.45	0.46
3:C:475:ALA:N	3:C:480:CYS:SG	2.88	0.46
3:C:826:VAL:HG13	3:C:1057:PRO:HG2	1.96	0.46
3:B:480:CYS:HB3	3:B:488:CYS:HB2	1.75	0.46
3:A:255:SER:O	3:A:256:SER:OG	2.33	0.46
3:A:486:PHE:CE1	2:D:119:ARG:HA	2.51	0.46
3:A:916:LEU:HD12	3:A:923:ILE:HD13	1.97	0.46
3:A:1076:THR:HG23	3:A:1097:SER:HB3	1.98	0.46
1:L:38:ARG:HA	1:L:38:ARG:NE	2.30	0.46
3:B:140:PHE:O	3:B:158:ARG:HB2	2.15	0.46
1:G:60:TYR:O	1:G:110:TYR:HA	2.16	0.46
3:A:206:LYS:HB2	3:A:223:LEU:HD22	1.96	0.46
3:A:736:VAL:HG21	3:A:1004:LEU:HD11	1.96	0.46
3:C:128:ILE:HD13	3:C:171:VAL:HG13	1.97	0.46
3:C:311:GLY:HA2	3:C:664:ILE:HG23	1.96	0.46
3:C:1106:GLN:HE21	3:C:1109:PHE:HB3	1.81	0.46

Continued on next page...

Continued from previous page...

Atom-1	Atom-2	Interatomic distance (Å)	Clash overlap (Å)
3:B:404:GLY:HA2	3:B:508:TYR:CE1	2.46	0.46
3:B:869:MET:SD	3:A:699:LEU:HD21	2.56	0.46
3:A:377:PHE:CE1	3:A:434:ILE:HG23	2.51	0.46
1:L:34:SER:OG	1:L:37:GLN:HB2	2.16	0.46
3:B:197:ILE:O	3:B:202:LYS:NZ	2.49	0.46
3:B:917:TYR:CE1	3:A:1079:PRO:HB3	2.51	0.46
3:B:1080:ALA:HB1	3:B:1087:ALA:O	2.15	0.46
3:B:1134:ASN:HB2	4:V:1:NAG:H83	1.96	0.46
2:H:38:LYS:HG3	2:H:101:GLN:OE1	2.16	0.46
3:B:328:ARG:NH2	3:B:533:LEU:HD23	2.31	0.46
3:B:568:ASP:HB2	3:B:574:ASP:HB2	1.98	0.46
3:B:1103:PHE:CG	3:B:1112:PRO:HB3	2.51	0.46
1:G:190:PHE:N	1:G:223:THR:HB	2.30	0.46
3:A:133:PHE:HD1	3:A:164:ASN:ND2	2.13	0.46
2:H:187:ALA:HB2	2:H:233:THR:HG22	1.97	0.46
3:C:699:LEU:HB3	3:A:873:TYR:CE1	2.50	0.46
3:B:577:ARG:HA	3:B:584:ILE:HA	1.97	0.46
3:B:873:TYR:HE1	3:A:699:LEU:HB3	1.80	0.46
3:A:1006:THR:O	3:A:1010[B]:GLN:HG2	2.16	0.46
3:C:81:ASN:HB2	3:C:239:GLN:HE22	1.81	0.46
3:C:399:SER:HB3	3:C:511:VAL:HG12	1.98	0.46
3:C:752:LEU:C	3:C:754:LEU:H	2.19	0.46
3:C:915:VAL:O	3:C:919:ASN:HB2	2.16	0.46
3:B:102:ARG:HA	3:B:102:ARG:HD3	1.56	0.46
1:L:49:VAL:HA	1:L:116:ARG:HG3	1.98	0.46
3:C:102:ARG:HB2	3:C:241:LEU:HD23	1.98	0.46
3:B:100:ILE:HG22	3:B:242:LEU:HD12	1.97	0.46
2:H:249:ASN:OD1	2:H:256:LYS:HG3	2.16	0.45
3:C:746:SER:OG	3:C:748:GLU:OE1	2.34	0.45
3:B:393:THR:HA	3:B:522:ALA:HA	1.98	0.45
1:G:111:PHE:CG	2:F:64:LEU:HD12	2.51	0.45
3:A:133:PHE:CE2	3:A:160:TYR:HA	2.51	0.45
3:A:752:LEU:C	3:A:754:LEU:H	2.19	0.45
1:L:85:ARG:HG2	1:L:99:ILE:HD11	1.98	0.45
3:C:343:ASN:ND2	4:R:1:NAG:H62	2.30	0.45
3:B:883:THR:HG23	3:A:707:TYR:HB2	1.98	0.45
2:H:111:ALA:O	2:H:129:VAL:HG12	2.16	0.45
2:F:24:GLN:HB2	2:F:42:LYS:HB2	1.98	0.45
2:D:105:LEU:HD12	2:D:106:THR:N	2.31	0.45
2:D:105:LEU:HD12	2:D:106:THR:H	1.81	0.45
1:L:113:GLN:HB2	1:L:122:PHE:CE1	2.51	0.45

Continued on next page...

Continued from previous page...

Atom-1	Atom-2	Interatomic distance (Å)	Clash overlap (Å)
1:L:217:GLN:HE21	1:L:222:SER:HA	1.81	0.45
3:C:854:LYS:HG3	3:C:859:THR:HA	1.98	0.45
3:A:295:PRO:HB2	3:A:608:VAL:HG21	1.98	0.45
3:B:477:SER:OG	1:G:52:TYR:OH	2.34	0.45
3:B:533:LEU:HB2	3:B:535:LYS:NZ	2.30	0.45
1:G:218:ASP:HB3	1:G:221:ASP:OD1	2.17	0.45
3:A:195:LYS:HG3	3:A:202:LYS:HB2	1.98	0.45
1:L:71:LEU:HA	1:L:82:VAL:HG21	1.99	0.45
3:C:555:SER:HB3	3:C:586:ASP:HB2	1.99	0.45
3:C:985:ASP:CG	3:C:987:PRO:HD2	2.37	0.45
3:B:186:PHE:O	3:B:211:ASN:HA	2.16	0.45
3:C:99:ASN:HB3	3:C:102:ARG:NH2	2.32	0.45
3:B:437:ASN:HA	3:B:508:TYR:HB2	1.97	0.45
3:B:528:LYS:HD3	3:B:529:LYS:HE3	1.98	0.45
3:B:914:ASN:ND2	3:A:1089:PHE:CE1	2.85	0.45
2:F:251:LYS:HB2	2:F:251:LYS:HE2	1.77	0.45
3:A:551:VAL:HG23	3:A:588:THR:HB	1.99	0.45
2:H:99:TYR:HB3	2:H:101:GLN:OE1	2.17	0.45
3:C:231:ILE:HG22	3:C:232:GLY:N	2.29	0.45
3:C:699:LEU:HD21	3:A:869:MET:HB3	1.99	0.45
3:C:906:PHE:CE2	3:C:916:LEU:HB2	2.52	0.45
3:B:535:LYS:HA	3:B:535:LYS:HD3	1.78	0.45
3:B:777:ASN:O	3:B:781:VAL:HG23	2.17	0.45
3:B:1038:LYS:HB3	3:B:1038:LYS:HE3	1.80	0.45
1:G:100:HIS:HB2	1:G:101:PRO:HD3	1.98	0.45
1:G:168:ILE:HG23	1:G:260:PHE:CE2	2.52	0.45
2:F:25:GLN:HB3	2:F:125:GLN:HG3	1.98	0.45
2:F:55:TRP:CZ2	2:F:115:CYS:HB3	2.52	0.45
3:A:905:ARG:HD3	3:A:1049:LEU:O	2.17	0.45
1:L:56:LEU:HD21	3:C:476:GLY:HA3	1.99	0.45
2:H:238:SER:O	2:H:242:GLN:N	2.48	0.45
3:C:197:ILE:HB	3:C:202:LYS:NZ	2.31	0.45
3:C:213:VAL:HG23	3:C:214:ARG:N	2.32	0.45
3:C:612:TYR:HB3	3:C:615:VAL:HG22	1.99	0.45
3:C:665:PRO:HB2	3:A:864:LEU:HD11	1.99	0.45
3:B:1048:HIS:HA	3:B:1066:THR:HG22	1.98	0.45
3:A:32:PHE:CD2	3:A:218:GLN:HG2	2.51	0.45
2:H:29:GLU:HG3	2:H:31:VAL:HG13	1.99	0.45
3:C:435:ALA:HB1	3:C:508:TYR:OH	2.17	0.45
3:C:941:THR:HG22	3:C:943:SER:H	1.82	0.45
3:B:497:PHE:HD2	3:B:507:PRO:HG3	1.82	0.45

Continued on next page...

Continued from previous page...

Atom-1	Atom-2	Interatomic distance (Å)	Clash overlap (Å)
3:A:404:GLY:HA2	3:A:508:TYR:CD2	2.52	0.45
2:D:23:LEU:HB2	2:D:46:TYR:OH	2.16	0.45
4:U:1:NAG:H62	4:U:2:NAG:HN2	1.81	0.45
3:B:95:THR:HB	3:B:186:PHE:CE2	2.52	0.44
2:D:59:SER:C	2:D:61:GLU:H	2.19	0.44
1:L:69:LYS:NZ	2:H:121:ASP:O	2.31	0.44
1:L:86:PHE:CD1	1:L:99:ILE:HD13	2.51	0.44
2:H:194:ASP:HA	2:H:225:LEU:HB3	1.98	0.44
3:B:1007:TYR:O	3:B:1010[A]:GLN:HG3	2.17	0.44
1:G:182:SER:HA	1:G:230:LEU:O	2.16	0.44
1:G:197:VAL:HG22	1:G:247:VAL:HG22	1.99	0.44
3:A:145:TYR:HB3	3:A:247:SER:HA	1.99	0.44
3:A:1082:CYS:HB2	3:A:1132:ILE:HD12	1.99	0.44
1:L:67:PRO:HB3	2:H:123:TRP:HB2	1.98	0.44
1:L:190:PHE:H	1:L:223:THR:HB	1.82	0.44
2:H:204:TRP:HB3	2:H:209:LEU:HB3	1.98	0.44
3:C:194:PHE:CD1	3:C:203:ILE:HG12	2.48	0.44
3:B:883:THR:HG21	3:A:705:VAL:HB	1.99	0.44
3:A:210:ILE:HD12	3:A:210:ILE:HA	1.87	0.44
3:A:1095:PHE:CE1	3:A:1104:VAL:HG22	2.52	0.44
3:C:102:ARG:HA	3:C:102:ARG:NE	2.31	0.44
3:C:786:LYS:HG3	3:C:787:GLN:OE1	2.17	0.44
3:B:543:PHE:HD2	3:B:576:VAL:HG11	1.82	0.44
3:B:1028:LYS:O	3:B:1032:CYS:HB2	2.17	0.44
2:F:25:GLN:HG2	2:F:127:THR:HG23	1.98	0.44
3:A:233:ILE:HA	5:A:1308:NAG:H82	1.99	0.44
3:A:502:GLY:O	3:A:506:GLN:HG2	2.17	0.44
3:C:65:PHE:HD1	3:C:80:ASP:HB3	1.79	0.44
3:C:81:ASN:N	3:C:82:PRO:HD3	2.33	0.44
3:C:485:GLY:N	3:C:488:CYS:HB3	2.29	0.44
3:C:1095:PHE:CE1	3:C:1104:VAL:HG22	2.52	0.44
3:B:486:PHE:HA	2:F:119:ARG:HG3	2.00	0.44
3:B:813:SER:HB2	3:B:815:ARG:HG3	1.98	0.44
3:B:895:GLN:HB3	3:A:705:VAL:HG12	2.00	0.44
1:G:58:GLN:O	1:G:112:CYS:HA	2.18	0.44
3:A:22:THR:HG21	3:A:77:LYS:H	1.83	0.44
3:A:393:THR:OG1	3:A:521:PRO:O	2.30	0.44
1:L:120:TRP:CH2	3:C:486:PHE:HB2	2.52	0.44
2:H:21:VAL:HG21	2:H:46:TYR:CD1	2.53	0.44
3:B:66:HIS:HB2	3:B:78:ARG:NH1	2.32	0.44
3:A:64:TRP:HE1	3:A:264:ALA:HB1	1.82	0.44

Continued on next page...

Continued from previous page...

Atom-1	Atom-2	Interatomic distance (Å)	Clash overlap (Å)
2:D:46:TYR:OH	2:D:122:TYR:HB3	2.18	0.44
2:D:55:TRP:CD1	2:D:100:MET:HB2	2.53	0.44
1:L:167:PHE:CZ	2:H:177:SER:HA	2.52	0.44
3:C:141:LEU:O	3:C:158:ARG:NH2	2.39	0.44
3:C:451:TYR:HB2	3:C:495:TYR:CD2	2.53	0.44
3:C:1138:TYR:OH	3:C:1143:PRO:HG2	2.18	0.44
3:B:68:ILE:HG22	3:B:70:VAL:HG23	2.00	0.44
3:B:670:ILE:HA	3:B:695:TYR:O	2.17	0.44
2:F:30:LEU:HD21	2:F:197:PRO:HG3	1.99	0.44
3:A:102:ARG:HG3	3:A:141:LEU:HD12	1.98	0.44
3:A:532:ASN:OD1	3:A:533:LEU:N	2.50	0.44
2:D:92:ASP:O	2:D:96:SER:N	2.51	0.44
3:B:28:TYR:HD1	3:B:61:ASN:HB3	1.83	0.44
1:G:115:SER:HA	1:G:120:TRP:CD1	2.52	0.44
3:A:186:PHE:HE1	3:A:263:ALA:HA	1.83	0.44
2:D:42:LYS:HA	2:D:97:THR:HG22	2.00	0.44
3:C:101:ILE:HA	3:C:242:LEU:HD13	1.99	0.44
3:C:418:ILE:HA	3:C:422:ASN:HD22	1.83	0.44
3:B:433:VAL:HG13	3:B:512:VAL:HG22	1.99	0.44
3:B:800:PHE:CG	3:B:898:PHE:HE2	2.36	0.44
2:F:39:ILE:O	2:F:99:TYR:HA	2.18	0.44
2:F:59:SER:OG	2:F:63:SER:HB3	2.18	0.44
3:A:28:TYR:HE1	3:A:63:THR:HG22	1.83	0.44
3:A:671:CYS:SG	3:A:697:MET:HB3	2.58	0.44
1:L:79:GLU:HB3	1:L:82:VAL:HG23	2.00	0.43
3:B:480:CYS:O	3:B:483:VAL:HG22	2.18	0.43
2:F:88:THR:HB	2:F:101:GLN:HB2	2.00	0.43
3:A:81:ASN:ND2	3:A:138:ASP:OD1	2.29	0.43
3:A:141:LEU:O	3:A:244:LEU:N	2.51	0.43
3:B:964:LYS:HE2	3:B:964:LYS:HB2	1.76	0.43
3:A:159:VAL:HG12	3:A:160:TYR:H	1.82	0.43
3:A:1106:GLN:NE2	3:A:1109:PHE:HB3	2.33	0.43
3:C:105:ILE:HG21	3:C:135:PHE:CZ	2.53	0.43
1:L:237:TYR:CD1	1:L:243:TYR:HE2	2.36	0.43
2:H:176:PRO:HG2	2:H:263:PRO:HG3	2.00	0.43
3:C:971:GLY:HA3	3:C:995:ARG:NH2	2.33	0.43
3:A:140:PHE:CZ	3:A:158:ARG:HG3	2.54	0.43
3:C:116:SER:N	3:C:131:CYS:O	2.50	0.43
3:B:108:THR:HG23	3:B:109:THR:HG23	2.00	0.43
3:B:960:ASN:O	3:B:963:VAL:HG22	2.18	0.43
3:B:1083:HIS:HB3	3:B:1088:HIS:NE2	2.33	0.43

Continued on next page...

Continued from previous page...

Atom-1	Atom-2	Interatomic distance (Å)	Clash overlap (Å)
3:A:338:PHE:HE2	3:A:342:PHE:CE2	2.36	0.43
3:B:337:PRO:O	3:B:340:GLU:HG3	2.19	0.43
3:A:811:LYS:HD3	3:A:814:LYS:HZ2	1.82	0.43
3:A:1072:GLU:HG3	5:A:1306:NAG:H81	2.00	0.43
1:E:59:TRP:HZ3	1:E:97:LEU:HB2	1.84	0.43
2:H:70:ILE:HD12	2:H:91:VAL:HG12	2.00	0.43
3:C:496:GLY:HA3	3:C:505:TYR:OH	2.19	0.43
3:C:1013:ILE:O	3:C:1017:GLU:HG3	2.18	0.43
3:B:517:LEU:HD23	3:B:517:LEU:H	1.84	0.43
3:B:919:ASN:O	3:B:923:ILE:HD12	2.19	0.43
1:E:68:PRO:HG2	2:D:123:TRP:CD2	2.54	0.43
1:L:52:TYR:HE2	3:C:477:SER:HA	1.84	0.43
3:B:802:PHE:CD1	3:B:805:ILE:HD11	2.54	0.43
1:G:31:LEU:HD23	1:G:31:LEU:HA	1.93	0.43
1:G:122:PHE:HB2	2:F:64:LEU:O	2.19	0.43
1:G:169:PHE:HB2	1:G:184:VAL:HB	2.01	0.43
2:F:192:VAL:HB	2:F:228:LEU:HD23	2.01	0.43
3:A:222:ALA:HB2	3:A:285:ILE:HB	2.00	0.43
3:B:41:LYS:HD2	3:A:562:PHE:CZ	2.53	0.43
3:A:98:SER:O	3:A:100:ILE:HG12	2.19	0.43
1:L:55:SER:OG	1:L:75:ALA:HB2	2.19	0.42
3:C:58:PHE:CD2	3:C:290:ASP:HB2	2.53	0.42
3:C:157:PHE:HE2	3:C:160:TYR:HB3	1.84	0.42
3:C:1089:PHE:HE2	3:A:917:TYR:CD2	2.37	0.42
3:B:20:THR:HG22	3:B:20:THR:O	2.18	0.42
3:B:855:PHE:CG	3:B:856:ASN:N	2.86	0.42
3:B:866:THR:H	3:B:869:MET:HE3	1.84	0.42
3:B:1073:LYS:HB3	3:B:1073:LYS:HE2	1.81	0.42
1:L:212:GLU:OE2	1:L:226:LEU:HG	2.18	0.42
3:B:104:TRP:HB3	3:B:106:PHE:HE1	1.84	0.42
3:B:474:GLN:NE2	3:B:476:GLY:O	2.52	0.42
3:A:353:TRP:HZ3	3:A:355:ARG:HB2	1.83	0.42
3:A:534:VAL:CG1	3:A:535:LYS:H	2.32	0.42
2:D:61:GLU:HG2	2:D:63:SER:HB2	2.00	0.42
3:C:66:HIS:HB2	3:C:78:ARG:NH1	2.35	0.42
3:C:394:ASN:C	3:C:394:ASN:ND2	2.71	0.42
3:B:340:GLU:HA	3:B:343:ASN:OD1	2.19	0.42
1:G:31:LEU:HD13	1:G:39:ALA:HB1	2.01	0.42
2:F:26:SER:HA	2:F:27:GLY:HA2	1.83	0.42
3:A:106:PHE:O	3:A:116:SER:HA	2.19	0.42
3:A:130:VAL:O	3:A:130:VAL:HG13	2.18	0.42

Continued on next page...

Continued from previous page...

Atom-1	Atom-2	Interatomic distance (Å)	Clash overlap (Å)
3:A:1014:ARG:O	3:A:1017:GLU:HG2	2.19	0.42
2:H:59:SER:HA	2:H:111:ALA:HB1	2.01	0.42
2:H:71:ASN:OD1	2:H:73:SER:OG	2.29	0.42
3:C:204:TYR:HA	3:C:225:PRO:HA	2.01	0.42
3:C:589:PRO:HD3	3:A:855:PHE:CZ	2.55	0.42
3:B:240:THR:HG21	3:B:265:TYR:CZ	2.55	0.42
2:F:57:LYS:HE3	2:F:111:ALA:HB3	2.00	0.42
3:A:455:LEU:HD21	3:A:493:GLN:OE1	2.18	0.42
1:L:100:HIS:CB	1:L:101:PRO:HD3	2.47	0.42
3:C:128:ILE:O	3:C:128:ILE:HG22	2.19	0.42
3:C:200:TYR:CZ	3:C:230:PRO:HB3	2.55	0.42
1:G:68:PRO:HG2	2:F:123:TRP:CZ2	2.55	0.42
3:A:326:ILE:HG23	3:A:541:PHE:HA	2.01	0.42
4:T:1:NAG:H5	4:T:2:NAG:C7	2.48	0.42
1:L:60:TYR:CD1	1:L:70:VAL:HG22	2.55	0.42
2:H:25:GLN:HE21	2:H:115:CYS:HB3	1.84	0.42
3:C:714:ILE:HD11	3:C:1094:VAL:HG21	2.01	0.42
3:C:986:PRO:HA	3:C:989:ALA:HB3	2.01	0.42
3:C:994:ASP:O	3:C:998:THR:HG23	2.20	0.42
3:B:794:ILE:HG13	3:B:794:ILE:O	2.19	0.42
1:G:127:LYS:HE3	1:G:127:LYS:HB3	1.73	0.42
2:F:201:THR:OG1	2:F:249:ASN:HB3	2.19	0.42
3:A:404:GLY:HA2	3:A:508:TYR:HD2	1.85	0.42
3:A:569:ILE:HD12	3:A:569:ILE:H	1.85	0.42
3:C:33:THR:HA	3:C:58:PHE:CD1	2.54	0.42
3:C:1043:CYS:HB2	3:C:1048:HIS:CG	2.55	0.42
3:B:329:PHE:C	3:B:579:PRO:HB2	2.39	0.42
3:B:429:PHE:HE2	3:B:433:VAL:HG23	1.84	0.42
3:B:433:VAL:HG22	3:B:512:VAL:HG13	2.01	0.42
3:B:718:PHE:CE1	3:B:923:ILE:HD11	2.54	0.42
3:A:64:TRP:HD1	3:A:65:PHE:H	1.67	0.42
3:B:245:HIS:HB2	3:B:259:THR:O	2.19	0.42
3:B:770:ILE:O	3:B:774:GLN:HG2	2.20	0.42
3:B:1083:HIS:CD2	3:B:1137:VAL:HG22	2.55	0.42
2:F:120:GLY:O	2:F:123:TRP:NE1	2.52	0.42
2:F:176:PRO:HG3	2:F:188:LEU:HB3	2.01	0.42
2:H:70:ILE:HD12	2:H:91:VAL:CG1	2.49	0.42
3:B:336:CYS:HB2	3:B:338:PHE:HD1	1.85	0.42
3:B:401:VAL:HG12	3:B:509:ARG:HG2	2.01	0.42
3:B:1079:PRO:HD2	3:B:1131:GLY:O	2.19	0.42
1:L:72:ILE:HA	1:L:78:VAL:HA	2.01	0.42

Continued on next page...

Continued from previous page...

Atom-1	Atom-2	Interatomic distance (Å)	Clash overlap (Å)
3:C:189:LEU:HG	3:C:191:GLU:HG3	2.01	0.42
3:C:312:ILE:HG12	3:C:598:ILE:HD13	2.02	0.42
3:C:906:PHE:HE1	3:C:1049:LEU:HD11	1.85	0.42
1:G:60:TYR:OH	2:F:119:ARG:O	2.17	0.42
3:A:296:LEU:O	3:A:299:THR:OG1	2.31	0.42
3:A:1079:PRO:HD2	3:A:1131:GLY:O	2.20	0.42
2:H:119:ARG:HH12	3:C:489:TYR:HA	1.84	0.41
3:C:144:TYR:HB2	3:C:155:SER:HB2	2.02	0.41
3:C:578:ASP:N	3:C:578:ASP:OD1	2.53	0.41
3:B:97:LYS:HG3	3:B:186:PHE:HA	2.02	0.41
3:A:457:ARG:NH1	3:A:467:ASP:OD2	2.53	0.41
3:A:474:GLN:HE22	3:A:481:ASN:H	1.68	0.41
1:L:26:GLN:OE1	1:L:126:THR:HG23	2.20	0.41
3:C:417:LYS:NZ	3:C:455:LEU:HB2	2.35	0.41
3:B:448:ASN:OD1	3:B:449:TYR:N	2.53	0.41
1:G:56:LEU:HB3	1:G:115:SER:HB2	2.02	0.41
3:A:105:ILE:HG13	3:A:241:LEU:HD11	2.01	0.41
3:A:193:VAL:HG23	3:A:223:LEU:HD12	2.01	0.41
3:A:384:PRO:HA	3:A:387:LEU:HD12	2.02	0.41
3:A:1102:TRP:HB2	3:A:1135:ASN:ND2	2.35	0.41
1:L:26:GLN:HE21	1:L:123:GLY:HA3	1.84	0.41
2:H:103:LYS:HE2	2:H:103:LYS:HB2	1.76	0.41
3:C:777:ASN:O	3:C:781:VAL:HG23	2.20	0.41
3:B:550:GLY:HA2	3:B:589:PRO:HA	2.02	0.41
2:F:56:MET:HA	2:F:67:ILE:H	1.86	0.41
3:A:89:GLY:HA3	3:A:270:LEU:HD12	2.02	0.41
3:A:1097:SER:HB2	3:A:1102:TRP:CD2	2.55	0.41
2:D:84:LYS:O	2:D:84:LYS:HG3	2.20	0.41
2:H:56:MET:HB3	2:H:56:MET:HE2	1.92	0.41
3:C:1106:GLN:NE2	3:C:1109:PHE:HB3	2.35	0.41
3:B:401:VAL:HG21	3:B:451:TYR:CD2	2.56	0.41
3:B:529:LYS:HE2	3:B:529:LYS:HB3	1.88	0.41
3:B:902:MET:HE1	3:B:1049:LEU:HD13	2.01	0.41
2:F:53:MET:HE2	2:F:115:CYS:HB2	2.00	0.41
1:E:63:LYS:HG3	1:E:64:PRO:HD2	2.02	0.41
1:E:114:GLN:HE22	1:E:116:ARG:HB2	1.85	0.41
3:C:578:ASP:OD2	3:C:581:THR:OG1	2.37	0.41
3:B:24:LEU:HD11	3:B:76:THR:HG21	2.02	0.41
3:B:208:THR:HA	3:B:209:PRO:HD3	1.94	0.41
3:B:417:LYS:HA	3:B:417:LYS:HD2	1.88	0.41
1:L:188:ASN:ND2	2:H:233:THR:HG21	2.35	0.41

Continued on next page...

Continued from previous page...

Atom-1	Atom-2	Interatomic distance (Å)	Clash overlap (Å)
1:L:196:LYS:HB3	1:L:248:THR:CG2	2.49	0.41
3:B:497:PHE:CD2	3:B:507:PRO:HG3	2.56	0.41
3:B:905:ARG:HD3	3:B:1049:LEU:O	2.20	0.41
3:A:362:VAL:HG13	3:A:362:VAL:O	2.20	0.41
3:A:725:GLU:OE1	3:A:1064:HIS:NE2	2.54	0.41
1:L:113:GLN:HB2	1:L:122:PHE:CD1	2.56	0.41
1:L:252:LEU:HD13	1:L:254:SER:O	2.21	0.41
3:C:442:ASP:O	3:C:448:ASN:ND2	2.53	0.41
3:C:747:THR:O	3:C:751:ASN:ND2	2.37	0.41
3:B:1110:TYR:CZ	3:B:1112:PRO:HG3	2.56	0.41
2:F:204:TRP:HH2	2:F:261:VAL:HG21	1.85	0.41
3:A:350:VAL:HG22	3:A:422:ASN:HB3	2.02	0.41
3:C:436:TRP:HE1	3:C:509:ARG:HD3	1.86	0.41
3:C:729:VAL:HG22	3:C:1059:GLY:HA2	2.03	0.41
3:C:1014:ARG:O	3:C:1018:ILE:HG12	2.21	0.41
3:B:767:LEU:HD23	3:B:767:LEU:HA	1.91	0.41
1:L:33:VAL:HG11	1:L:102:VAL:HG11	2.02	0.41
1:L:49:VAL:O	1:L:55:SER:HA	2.21	0.41
1:L:252:LEU:HD22	1:L:256:VAL:HG23	2.02	0.41
2:H:221:GLN:NE2	2:H:227:SER:HB3	2.35	0.41
2:H:259:LYS:HE2	2:H:259:LYS:HB2	1.89	0.41
3:C:1004:LEU:O	3:C:1008:VAL:HG23	2.21	0.41
3:C:1038:LYS:HB3	3:C:1038:LYS:HE3	1.79	0.41
3:B:752:LEU:C	3:B:754:LEU:H	2.22	0.41
3:B:1032:CYS:HB3	3:B:1051:SER:OG	2.21	0.41
2:F:21:VAL:HG11	2:F:117:ARG:NH1	2.36	0.41
3:A:273:ARG:HA	3:A:273:ARG:HD3	1.78	0.41
3:A:927:PHE:CZ	3:A:931:ILE:HD11	2.56	0.41
3:A:1053:PRO:O	3:A:1054:GLN:NE2	2.50	0.41
1:E:45:ALA:HB2	1:E:57:MET:HE1	2.03	0.41
1:L:131:LYS:HA	1:L:191:TYR:OH	2.21	0.41
3:C:122:ASN:HB3	3:C:125:ASN:OD1	2.21	0.41
3:C:126:VAL:HG23	3:C:126:VAL:O	2.21	0.41
3:B:106:PHE:HZ	3:B:194:PHE:CD2	2.39	0.41
3:B:226:LEU:HD23	3:B:226:LEU:HA	1.90	0.41
3:B:376:THR:O	3:B:435:ALA:HB3	2.20	0.41
3:B:1083:HIS:HB3	3:B:1088:HIS:CD2	2.56	0.41
1:G:72:ILE:HA	1:G:78:VAL:HA	2.03	0.41
2:F:59:SER:C	2:F:61:GLU:H	2.24	0.41
3:C:1134:ASN:HB2	4:M:1:NAG:H83	2.04	0.40
3:B:535:LYS:HE3	3:B:585:LEU:HD13	2.03	0.40

Continued on next page...

Continued from previous page...

Atom-1	Atom-2	Interatomic distance (Å)	Clash overlap (Å)
2:F:30:LEU:HD23	2:F:30:LEU:HA	1.89	0.40
3:A:193:VAL:HG13	3:A:270:LEU:HD11	2.03	0.40
3:A:347:PHE:HE2	3:A:509:ARG:HH11	1.68	0.40
1:L:117:LYS:O	1:L:120:TRP:HD1	2.04	0.40
3:C:431:GLY:HA2	3:C:515:PHE:CD2	2.56	0.40
3:C:904:TYR:N	3:C:904:TYR:CD1	2.88	0.40
3:B:90:VAL:HG11	3:B:238:PHE:CE1	2.56	0.40
3:B:203:ILE:O	3:B:226:LEU:HB2	2.20	0.40
3:B:973:ILE:HD11	3:B:980:ILE:HG12	2.02	0.40
3:B:1081:ILE:O	3:B:1088:HIS:HB2	2.20	0.40
2:F:117:ARG:HD3	2:F:121:ASP:OD1	2.20	0.40
3:A:388:ASN:O	3:A:527:PRO:HD2	2.21	0.40
3:C:123:ALA:HA	3:C:177:MET:HG3	2.04	0.40
3:C:304:LYS:HE3	3:C:304:LYS:HB3	1.84	0.40
3:C:308:VAL:O	3:C:313:TYR:OH	2.21	0.40
3:C:699:LEU:HD11	3:A:869:MET:HB3	2.02	0.40
3:B:393:THR:HG21	3:B:520:ALA:HB3	2.03	0.40
2:F:200:VAL:HG11	2:F:248:VAL:HG13	2.03	0.40
2:F:262:GLU:HG2	2:F:263:PRO:HD2	2.04	0.40
3:A:564:GLN:O	3:A:577:ARG:HG3	2.21	0.40
1:E:24:LEU:HD11	1:E:114:GLN:HB2	2.03	0.40
3:C:563:GLN:HG3	3:A:43:PHE:HB2	2.04	0.40
3:C:568:ASP:OD2	3:C:572:THR:OG1	2.38	0.40
3:B:278:LYS:HB2	3:B:306:PHE:CZ	2.57	0.40
3:B:280:ASN:ND2	3:B:284:THR:HB	2.35	0.40
3:B:447:GLY:HA2	3:B:497:PHE:O	2.22	0.40
3:A:669:GLY:O	3:A:697:MET:HG2	2.21	0.40
3:A:973:ILE:HG13	3:A:984:LEU:HD11	2.03	0.40
3:C:44:ARG:HD2	3:C:279:TYR:CZ	2.56	0.40
3:C:985:ASP:HB3	3:C:988:GLU:OE2	2.21	0.40
3:C:1083:HIS:ND1	3:C:1136:THR:HA	2.36	0.40
3:B:143:VAL:HB	3:B:179:LEU:HD22	2.02	0.40
3:B:274:THR:OG1	3:B:291:CYS:HB2	2.20	0.40
3:B:788:ILE:CD1	3:A:699:LEU:HB2	2.51	0.40
3:B:983:ARG:HB3	3:A:382:VAL:HG12	2.04	0.40
1:G:200:LYS:CG	1:G:244:ALA:HB3	2.51	0.40
1:G:200:LYS:NZ	1:G:246:GLU:HB2	2.36	0.40
2:F:75:GLY:HA2	2:F:91:VAL:HG21	2.03	0.40

There are no symmetry-related clashes.

5.3 Torsion angles [i](#)

5.3.1 Protein backbone [i](#)

In the following table, the Percentiles column shows the percent Ramachandran outliers of the chain as a percentile score with respect to all PDB entries followed by that with respect to all EM entries.

The Analysed column shows the number of residues for which the backbone conformation was analysed, and the total number of residues.

Mol	Chain	Analysed	Favoured	Allowed	Outliers	Percentiles	
1	E	108/265 (41%)	96 (89%)	11 (10%)	1 (1%)	14	43
1	G	213/265 (80%)	198 (93%)	13 (6%)	2 (1%)	14	43
1	L	213/265 (80%)	199 (93%)	12 (6%)	2 (1%)	14	43
2	D	111/263 (42%)	99 (89%)	11 (10%)	1 (1%)	14	43
2	F	205/263 (78%)	191 (93%)	13 (6%)	1 (0%)	25	55
2	H	205/263 (78%)	190 (93%)	14 (7%)	1 (0%)	25	55
3	A	1044/1288 (81%)	948 (91%)	91 (9%)	5 (0%)	25	55
3	B	1044/1288 (81%)	967 (93%)	71 (7%)	6 (1%)	22	51
3	C	1044/1288 (81%)	942 (90%)	97 (9%)	5 (0%)	25	55
All	All	4187/5448 (77%)	3830 (92%)	333 (8%)	24 (1%)	24	51

All (24) Ramachandran outliers are listed below:

Mol	Chain	Res	Type
3	C	186	PHE
3	C	293	LEU
3	B	173	GLN
3	C	529	LYS
3	C	536	ASN
3	B	1113	GLN
3	A	543	PHE
3	A	1113	GLN
3	B	332	ILE
2	D	104	SER
1	L	189	ASN
2	H	104	SER
3	B	293	LEU
1	G	28	PRO
2	F	104	SER
1	E	28	PRO

Continued on next page...

Continued from previous page...

Mol	Chain	Res	Type
3	B	720	ILE
3	B	813	SER
1	G	189	ASN
3	A	253	ASP
3	A	324	GLU
3	A	720	ILE
1	L	28	PRO
3	C	503	VAL

5.3.2 Protein sidechains [i](#)

In the following table, the Percentiles column shows the percent sidechain outliers of the chain as a percentile score with respect to all PDB entries followed by that with respect to all EM entries.

The Analysed column shows the number of residues for which the sidechain conformation was analysed, and the total number of residues.

Mol	Chain	Analysed	Rotameric	Outliers	Percentiles	
1	E	90/227 (40%)	89 (99%)	1 (1%)	70	81
1	G	184/227 (81%)	184 (100%)	0	100	100
1	L	184/227 (81%)	182 (99%)	2 (1%)	70	81
2	D	92/224 (41%)	91 (99%)	1 (1%)	70	81
2	F	175/224 (78%)	175 (100%)	0	100	100
2	H	175/224 (78%)	175 (100%)	0	100	100
3	A	888/1113 (80%)	886 (100%)	2 (0%)	92	96
3	B	888/1113 (80%)	886 (100%)	2 (0%)	92	96
3	C	888/1113 (80%)	886 (100%)	2 (0%)	92	96
All	All	3564/4692 (76%)	3554 (100%)	10 (0%)	91	95

All (10) residues with a non-rotameric sidechain are listed below:

Mol	Chain	Res	Type
1	L	44	ARG
1	L	85	ARG
3	C	394	ASN
3	C	690	GLN
3	B	1010[A]	GLN
3	B	1010[B]	GLN

Continued on next page...

Continued from previous page...

Mol	Chain	Res	Type
3	A	1010[A]	GLN
3	A	1010[B]	GLN
1	E	127	LYS
2	D	119	ARG

Sometimes sidechains can be flipped to improve hydrogen bonding and reduce clashes. All (13) such sidechains are listed below:

Mol	Chain	Res	Type
1	L	211	GLN
1	L	217	GLN
2	H	221	GLN
3	C	185	ASN
3	C	211	ASN
3	B	69	HIS
3	B	901	GLN
1	G	58	GLN
2	F	125	GLN
3	A	164	ASN
1	E	26	GLN
1	E	113	GLN
1	E	114	GLN

5.3.3 RNA [i](#)

There are no RNA molecules in this entry.

5.4 Non-standard residues in protein, DNA, RNA chains [i](#)

There are no non-standard protein/DNA/RNA residues in this entry.

5.5 Carbohydrates [i](#)

58 monosaccharides are modelled in this entry.

In the following table, the Counts columns list the number of bonds (or angles) for which Mogul statistics could be retrieved, the number of bonds (or angles) that are observed in the model and the number of bonds (or angles) that are defined in the Chemical Component Dictionary. The Link column lists molecule types, if any, to which the group is linked. The Z score for a bond length (or angle) is the number of standard deviations the observed value is removed from the

expected value. A bond length (or angle) with $|Z| > 2$ is considered an outlier worth inspection. RMSZ is the root-mean-square of all Z scores of the bond lengths (or angles).

Mol	Type	Chain	Res	Link	Bond lengths			Bond angles		
					Counts	RMSZ	$\# Z > 2$	Counts	RMSZ	$\# Z > 2$
4	NAG	I	1	4,3	14,14,15	0.84	1 (7%)	17,19,21	1.32	1 (5%)
4	NAG	I	2	4	14,14,15	0.21	0	17,19,21	0.45	0
4	NAG	J	1	4,3	14,14,15	0.75	1 (7%)	17,19,21	0.88	1 (5%)
4	NAG	J	2	4	14,14,15	0.23	0	17,19,21	0.38	0
4	NAG	K	1	4,3	14,14,15	0.92	2 (14%)	17,19,21	0.93	1 (5%)
4	NAG	K	2	4	14,14,15	0.23	0	17,19,21	0.41	0
4	NAG	M	1	4,3	14,14,15	0.50	0	17,19,21	0.65	0
4	NAG	M	2	4	14,14,15	0.24	0	17,19,21	0.51	0
4	NAG	N	1	4,3	14,14,15	0.31	0	17,19,21	0.54	0
4	NAG	N	2	4	14,14,15	0.26	0	17,19,21	0.41	0
4	NAG	O	1	4,3	14,14,15	0.16	0	17,19,21	0.41	0
4	NAG	O	2	4	14,14,15	0.55	0	17,19,21	0.76	0
4	NAG	P	1	4,3	14,14,15	0.21	0	17,19,21	0.41	0
4	NAG	P	2	4	14,14,15	0.20	0	17,19,21	0.47	0
4	NAG	Q	1	4,3	14,14,15	0.37	0	17,19,21	0.44	0
4	NAG	Q	2	4	14,14,15	0.24	0	17,19,21	0.47	0
4	NAG	R	1	4,3	14,14,15	0.57	0	17,19,21	1.22	1 (5%)
4	NAG	R	2	4	14,14,15	0.59	1 (7%)	17,19,21	0.72	1 (5%)
4	NAG	S	1	4,3	14,14,15	0.53	0	17,19,21	0.45	0
4	NAG	S	2	4	14,14,15	0.24	0	17,19,21	0.50	0
4	NAG	T	1	4,3	14,14,15	0.85	1 (7%)	17,19,21	1.58	1 (5%)
4	NAG	T	2	4	14,14,15	0.20	0	17,19,21	0.45	0
4	NAG	U	1	4,3	14,14,15	0.81	1 (7%)	17,19,21	1.07	1 (5%)
4	NAG	U	2	4	14,14,15	0.28	0	17,19,21	0.50	0
4	NAG	V	1	4,3	14,14,15	0.44	0	17,19,21	0.48	0
4	NAG	V	2	4	14,14,15	0.24	0	17,19,21	0.47	0
4	NAG	W	1	4,3	14,14,15	1.18	1 (7%)	17,19,21	1.16	1 (5%)
4	NAG	W	2	4	14,14,15	0.23	0	17,19,21	0.41	0
4	NAG	X	1	4,3	14,14,15	0.27	0	17,19,21	0.41	0
4	NAG	X	2	4	14,14,15	0.27	0	17,19,21	0.53	0
4	NAG	Y	1	4,3	14,14,15	0.23	0	17,19,21	0.45	0
4	NAG	Y	2	4	14,14,15	0.19	0	17,19,21	0.43	0
4	NAG	Z	1	4,3	14,14,15	0.65	1 (7%)	17,19,21	0.64	0
4	NAG	Z	2	4	14,14,15	0.24	0	17,19,21	0.46	0
4	NAG	a	1	4,3	14,14,15	0.30	0	17,19,21	0.36	0
4	NAG	a	2	4	14,14,15	0.23	0	17,19,21	0.49	0
4	NAG	b	1	4,3	14,14,15	0.24	0	17,19,21	0.39	0
4	NAG	b	2	4	14,14,15	1.07	1 (7%)	17,19,21	1.24	1 (5%)

Mol	Type	Chain	Res	Link	Bond lengths			Bond angles		
					Counts	RMSZ	# Z > 2	Counts	RMSZ	# Z > 2
4	NAG	c	1	4,3	14,14,15	0.84	1 (7%)	17,19,21	1.48	1 (5%)
4	NAG	c	2	4	14,14,15	0.23	0	17,19,21	0.46	0
4	NAG	d	1	4,3	14,14,15	0.86	1 (7%)	17,19,21	1.33	1 (5%)
4	NAG	d	2	4	14,14,15	0.23	0	17,19,21	0.48	0
4	NAG	e	1	4,3	14,14,15	0.60	0	17,19,21	1.00	1 (5%)
4	NAG	e	2	4	14,14,15	0.41	0	17,19,21	0.41	0
4	NAG	f	1	4,3	14,14,15	0.49	0	17,19,21	0.51	0
4	NAG	f	2	4	14,14,15	0.23	0	17,19,21	0.48	0
4	NAG	g	1	4,3	14,14,15	0.20	0	17,19,21	0.40	0
4	NAG	g	2	4	14,14,15	0.28	0	17,19,21	0.43	0
4	NAG	h	1	4,3	14,14,15	0.26	0	17,19,21	0.48	0
4	NAG	h	2	4	14,14,15	0.29	0	17,19,21	0.61	0
4	NAG	i	1	4,3	14,14,15	0.27	0	17,19,21	0.48	0
4	NAG	i	2	4	14,14,15	0.23	0	17,19,21	0.39	0
4	NAG	j	1	4,3	14,14,15	0.32	0	17,19,21	0.47	0
4	NAG	j	2	4	14,14,15	0.24	0	17,19,21	0.43	0
4	NAG	k	1	4,3	14,14,15	0.37	0	17,19,21	0.43	0
4	NAG	k	2	4	14,14,15	0.29	0	17,19,21	0.54	0
4	NAG	l	1	4,3	14,14,15	0.37	0	17,19,21	0.56	0
4	NAG	l	2	4	14,14,15	0.21	0	17,19,21	0.51	0

In the following table, the Chirals column lists the number of chiral outliers, the number of chiral centers analysed, the number of these observed in the model and the number defined in the Chemical Component Dictionary. Similar counts are reported in the Torsion and Rings columns. '-' means no outliers of that kind were identified.

Mol	Type	Chain	Res	Link	Chirals	Torsions	Rings
4	NAG	I	1	4,3	-	3/6/23/26	0/1/1/1
4	NAG	I	2	4	-	2/6/23/26	0/1/1/1
4	NAG	J	1	4,3	-	1/6/23/26	0/1/1/1
4	NAG	J	2	4	-	2/6/23/26	0/1/1/1
4	NAG	K	1	4,3	-	2/6/23/26	0/1/1/1
4	NAG	K	2	4	-	2/6/23/26	0/1/1/1
4	NAG	M	1	4,3	-	2/6/23/26	0/1/1/1
4	NAG	M	2	4	-	4/6/23/26	0/1/1/1
4	NAG	N	1	4,3	-	2/6/23/26	0/1/1/1
4	NAG	N	2	4	-	4/6/23/26	0/1/1/1
4	NAG	O	1	4,3	-	2/6/23/26	0/1/1/1
4	NAG	O	2	4	-	4/6/23/26	0/1/1/1

Continued on next page...

Continued from previous page...

Mol	Type	Chain	Res	Link	Chirals	Torsions	Rings
4	NAG	P	1	4,3	-	0/6/23/26	0/1/1/1
4	NAG	P	2	4	-	2/6/23/26	0/1/1/1
4	NAG	Q	1	4,3	-	1/6/23/26	0/1/1/1
4	NAG	Q	2	4	-	2/6/23/26	0/1/1/1
4	NAG	R	1	4,3	-	4/6/23/26	0/1/1/1
4	NAG	R	2	4	-	1/6/23/26	0/1/1/1
4	NAG	S	1	4,3	-	4/6/23/26	0/1/1/1
4	NAG	S	2	4	-	2/6/23/26	0/1/1/1
4	NAG	T	1	4,3	-	4/6/23/26	0/1/1/1
4	NAG	T	2	4	-	2/6/23/26	0/1/1/1
4	NAG	U	1	4,3	-	4/6/23/26	0/1/1/1
4	NAG	U	2	4	-	2/6/23/26	0/1/1/1
4	NAG	V	1	4,3	-	4/6/23/26	0/1/1/1
4	NAG	V	2	4	-	2/6/23/26	0/1/1/1
4	NAG	W	1	4,3	-	4/6/23/26	0/1/1/1
4	NAG	W	2	4	-	2/6/23/26	0/1/1/1
4	NAG	X	1	4,3	-	2/6/23/26	0/1/1/1
4	NAG	X	2	4	-	2/6/23/26	0/1/1/1
4	NAG	Y	1	4,3	-	0/6/23/26	0/1/1/1
4	NAG	Y	2	4	-	2/6/23/26	0/1/1/1
4	NAG	Z	1	4,3	-	2/6/23/26	0/1/1/1
4	NAG	Z	2	4	-	2/6/23/26	0/1/1/1
4	NAG	a	1	4,3	-	2/6/23/26	0/1/1/1
4	NAG	a	2	4	-	2/6/23/26	0/1/1/1
4	NAG	b	1	4,3	-	4/6/23/26	0/1/1/1
4	NAG	b	2	4	-	2/6/23/26	0/1/1/1
4	NAG	c	1	4,3	-	3/6/23/26	0/1/1/1
4	NAG	c	2	4	-	2/6/23/26	0/1/1/1
4	NAG	d	1	4,3	-	2/6/23/26	0/1/1/1
4	NAG	d	2	4	-	2/6/23/26	0/1/1/1
4	NAG	e	1	4,3	-	4/6/23/26	0/1/1/1
4	NAG	e	2	4	-	0/6/23/26	0/1/1/1
4	NAG	f	1	4,3	-	2/6/23/26	0/1/1/1
4	NAG	f	2	4	-	2/6/23/26	0/1/1/1
4	NAG	g	1	4,3	-	4/6/23/26	0/1/1/1

Continued on next page...

Continued from previous page...

Mol	Type	Chain	Res	Link	Chirals	Torsions	Rings
4	NAG	g	2	4	-	2/6/23/26	0/1/1/1
4	NAG	h	1	4,3	-	2/6/23/26	0/1/1/1
4	NAG	h	2	4	-	4/6/23/26	0/1/1/1
4	NAG	i	1	4,3	-	0/6/23/26	0/1/1/1
4	NAG	i	2	4	-	0/6/23/26	0/1/1/1
4	NAG	j	1	4,3	-	1/6/23/26	0/1/1/1
4	NAG	j	2	4	-	3/6/23/26	0/1/1/1
4	NAG	k	1	4,3	-	4/6/23/26	0/1/1/1
4	NAG	k	2	4	-	4/6/23/26	0/1/1/1
4	NAG	l	1	4,3	-	0/6/23/26	0/1/1/1
4	NAG	l	2	4	-	2/6/23/26	0/1/1/1

All (12) bond length outliers are listed below:

Mol	Chain	Res	Type	Atoms	Z	Observed(Å)	Ideal(Å)
4	W	1	NAG	O5-C1	-3.97	1.37	1.43
4	b	2	NAG	O5-C1	3.65	1.49	1.43
4	d	1	NAG	O5-C1	3.12	1.48	1.43
4	T	1	NAG	O5-C1	3.05	1.48	1.43
4	c	1	NAG	O5-C1	3.04	1.48	1.43
4	I	1	NAG	O5-C1	3.04	1.48	1.43
4	U	1	NAG	O5-C1	-2.93	1.38	1.43
4	K	1	NAG	O5-C1	2.57	1.48	1.43
4	J	1	NAG	O5-C1	2.30	1.47	1.43
4	Z	1	NAG	O5-C1	-2.28	1.39	1.43
4	K	1	NAG	C1-C2	2.15	1.55	1.52
4	R	2	NAG	C1-C2	2.06	1.55	1.52

All (12) bond angle outliers are listed below:

Mol	Chain	Res	Type	Atoms	Z	Observed(°)	Ideal(°)
4	T	1	NAG	C1-O5-C5	6.20	120.50	112.19
4	c	1	NAG	C1-O5-C5	5.81	119.97	112.19
4	I	1	NAG	C1-O5-C5	5.21	119.17	112.19
4	d	1	NAG	C1-O5-C5	5.18	119.13	112.19
4	b	2	NAG	C1-O5-C5	4.86	118.70	112.19
4	R	1	NAG	C1-O5-C5	4.64	118.40	112.19
4	K	1	NAG	C1-O5-C5	3.55	116.95	112.19
4	e	1	NAG	C1-O5-C5	3.53	116.92	112.19
4	J	1	NAG	C1-O5-C5	3.31	116.62	112.19

Continued on next page...

Continued from previous page...

Mol	Chain	Res	Type	Atoms	Z	Observed(°)	Ideal(°)
4	W	1	NAG	C3-C4-C5	3.03	115.73	110.23
4	U	1	NAG	C1-O5-C5	2.71	115.82	112.19
4	R	2	NAG	C1-O5-C5	2.51	115.55	112.19

There are no chirality outliers.

All (133) torsion outliers are listed below:

Mol	Chain	Res	Type	Atoms
4	W	1	NAG	C4-C5-C6-O6
4	k	2	NAG	O5-C5-C6-O6
4	Y	2	NAG	O5-C5-C6-O6
4	Z	1	NAG	O5-C5-C6-O6
4	K	1	NAG	C4-C5-C6-O6
4	b	1	NAG	C4-C5-C6-O6
4	U	1	NAG	O5-C5-C6-O6
4	K	2	NAG	O5-C5-C6-O6
4	b	2	NAG	O5-C5-C6-O6
4	j	2	NAG	O5-C5-C6-O6
4	J	2	NAG	O5-C5-C6-O6
4	N	2	NAG	O5-C5-C6-O6
4	O	2	NAG	O5-C5-C6-O6
4	R	1	NAG	O5-C5-C6-O6
4	T	1	NAG	O5-C5-C6-O6
4	U	2	NAG	O5-C5-C6-O6
4	W	1	NAG	O5-C5-C6-O6
4	X	1	NAG	O5-C5-C6-O6
4	k	1	NAG	O5-C5-C6-O6
4	K	2	NAG	C4-C5-C6-O6
4	h	2	NAG	O5-C5-C6-O6
4	Y	2	NAG	C4-C5-C6-O6
4	Z	1	NAG	C4-C5-C6-O6
4	k	1	NAG	C4-C5-C6-O6
4	e	1	NAG	O5-C5-C6-O6
4	c	2	NAG	C4-C5-C6-O6
4	K	1	NAG	O5-C5-C6-O6
4	V	1	NAG	O5-C5-C6-O6
4	g	2	NAG	O5-C5-C6-O6
4	S	2	NAG	O5-C5-C6-O6
4	Z	2	NAG	O5-C5-C6-O6
4	l	2	NAG	O5-C5-C6-O6
4	U	1	NAG	C4-C5-C6-O6
4	X	1	NAG	C4-C5-C6-O6

Continued on next page...

Continued from previous page...

Mol	Chain	Res	Type	Atoms
4	k	2	NAG	C4-C5-C6-O6
4	b	1	NAG	O5-C5-C6-O6
4	N	2	NAG	C4-C5-C6-O6
4	R	1	NAG	C4-C5-C6-O6
4	b	2	NAG	C4-C5-C6-O6
4	O	1	NAG	O5-C5-C6-O6
4	S	1	NAG	O5-C5-C6-O6
4	g	2	NAG	C4-C5-C6-O6
4	l	2	NAG	C4-C5-C6-O6
4	j	2	NAG	C4-C5-C6-O6
4	O	2	NAG	C4-C5-C6-O6
4	P	2	NAG	O5-C5-C6-O6
4	J	2	NAG	C4-C5-C6-O6
4	O	1	NAG	C4-C5-C6-O6
4	S	1	NAG	C4-C5-C6-O6
4	U	2	NAG	C4-C5-C6-O6
4	d	2	NAG	O5-C5-C6-O6
4	Z	2	NAG	C4-C5-C6-O6
4	h	2	NAG	C4-C5-C6-O6
4	P	2	NAG	C4-C5-C6-O6
4	I	1	NAG	C8-C7-N2-C2
4	I	1	NAG	O7-C7-N2-C2
4	M	1	NAG	C8-C7-N2-C2
4	M	1	NAG	O7-C7-N2-C2
4	M	2	NAG	C8-C7-N2-C2
4	M	2	NAG	O7-C7-N2-C2
4	N	1	NAG	C8-C7-N2-C2
4	N	1	NAG	O7-C7-N2-C2
4	N	2	NAG	C8-C7-N2-C2
4	N	2	NAG	O7-C7-N2-C2
4	R	1	NAG	C8-C7-N2-C2
4	R	1	NAG	O7-C7-N2-C2
4	S	1	NAG	C8-C7-N2-C2
4	S	1	NAG	O7-C7-N2-C2
4	T	1	NAG	C8-C7-N2-C2
4	T	1	NAG	O7-C7-N2-C2
4	U	1	NAG	C8-C7-N2-C2
4	U	1	NAG	O7-C7-N2-C2
4	V	1	NAG	C8-C7-N2-C2
4	V	1	NAG	O7-C7-N2-C2
4	V	2	NAG	C8-C7-N2-C2
4	V	2	NAG	O7-C7-N2-C2

Continued on next page...

Continued from previous page...

Mol	Chain	Res	Type	Atoms
4	W	1	NAG	C8-C7-N2-C2
4	W	1	NAG	O7-C7-N2-C2
4	W	2	NAG	C8-C7-N2-C2
4	W	2	NAG	O7-C7-N2-C2
4	a	1	NAG	C8-C7-N2-C2
4	a	1	NAG	O7-C7-N2-C2
4	b	1	NAG	C8-C7-N2-C2
4	b	1	NAG	O7-C7-N2-C2
4	c	1	NAG	C8-C7-N2-C2
4	c	1	NAG	O7-C7-N2-C2
4	d	1	NAG	C8-C7-N2-C2
4	d	1	NAG	O7-C7-N2-C2
4	f	1	NAG	C8-C7-N2-C2
4	f	1	NAG	O7-C7-N2-C2
4	f	2	NAG	C8-C7-N2-C2
4	f	2	NAG	O7-C7-N2-C2
4	g	1	NAG	C8-C7-N2-C2
4	g	1	NAG	O7-C7-N2-C2
4	k	1	NAG	C8-C7-N2-C2
4	k	1	NAG	O7-C7-N2-C2
4	k	2	NAG	C8-C7-N2-C2
4	k	2	NAG	O7-C7-N2-C2
4	Q	2	NAG	O5-C5-C6-O6
4	c	2	NAG	O5-C5-C6-O6
4	M	2	NAG	O5-C5-C6-O6
4	d	2	NAG	C4-C5-C6-O6
4	e	1	NAG	C4-C5-C6-O6
4	V	1	NAG	C4-C5-C6-O6
4	g	1	NAG	C4-C5-C6-O6
4	T	1	NAG	C4-C5-C6-O6
4	I	2	NAG	O5-C5-C6-O6
4	a	2	NAG	O5-C5-C6-O6
4	c	1	NAG	O5-C5-C6-O6
4	I	2	NAG	C4-C5-C6-O6
4	S	2	NAG	C4-C5-C6-O6
4	a	2	NAG	C4-C5-C6-O6
4	I	1	NAG	O5-C5-C6-O6
4	J	1	NAG	O5-C5-C6-O6
4	g	1	NAG	O5-C5-C6-O6
4	Q	2	NAG	C4-C5-C6-O6
4	M	2	NAG	C4-C5-C6-O6
4	O	2	NAG	C1-C2-N2-C7

Continued on next page...

Continued from previous page...

Mol	Chain	Res	Type	Atoms
4	X	2	NAG	C1-C2-N2-C7
4	e	1	NAG	C1-C2-N2-C7
4	h	1	NAG	C4-C5-C6-O6
4	O	2	NAG	C3-C2-N2-C7
4	X	2	NAG	C3-C2-N2-C7
4	h	2	NAG	C3-C2-N2-C7
4	T	2	NAG	C4-C5-C6-O6
4	j	1	NAG	C4-C5-C6-O6
4	T	2	NAG	O5-C5-C6-O6
4	h	1	NAG	O5-C5-C6-O6
4	Q	1	NAG	C4-C5-C6-O6
4	h	2	NAG	C1-C2-N2-C7
4	j	2	NAG	C1-C2-N2-C7
4	e	1	NAG	C3-C2-N2-C7
4	R	2	NAG	C4-C5-C6-O6

There are no ring outliers.

10 monomers are involved in 9 short contacts:

Mol	Chain	Res	Type	Clashes	Symm-Clashes
4	U	1	NAG	1	0
4	V	1	NAG	2	0
4	T	1	NAG	1	0
4	Z	1	NAG	1	0
4	O	2	NAG	1	0
4	M	1	NAG	1	0
4	T	2	NAG	1	0
4	U	2	NAG	1	0
4	R	2	NAG	1	0
4	R	1	NAG	2	0

The following is a two-dimensional graphical depiction of Mogul quality analysis of bond lengths, bond angles, torsion angles, and ring geometry for oligosaccharide.

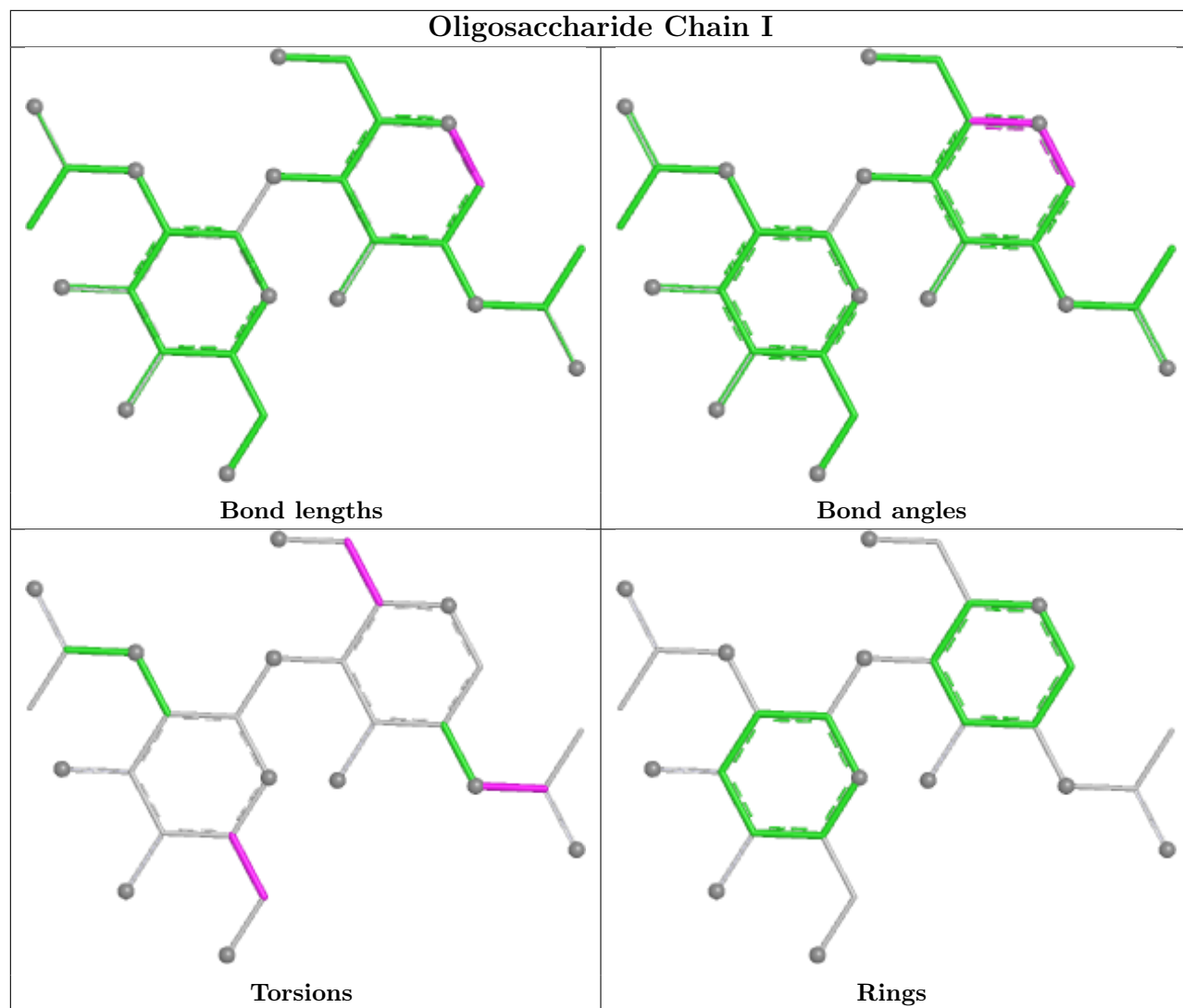

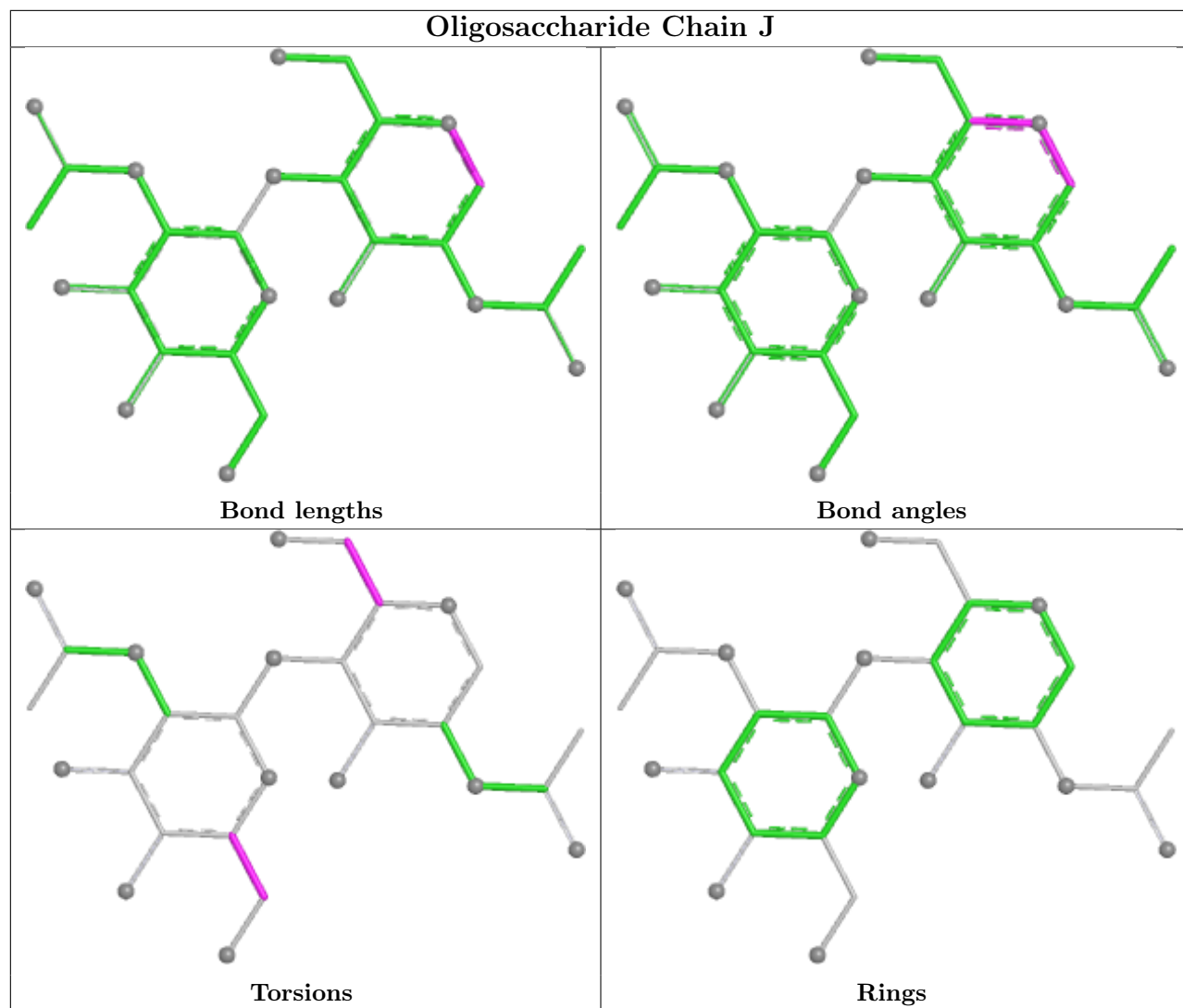

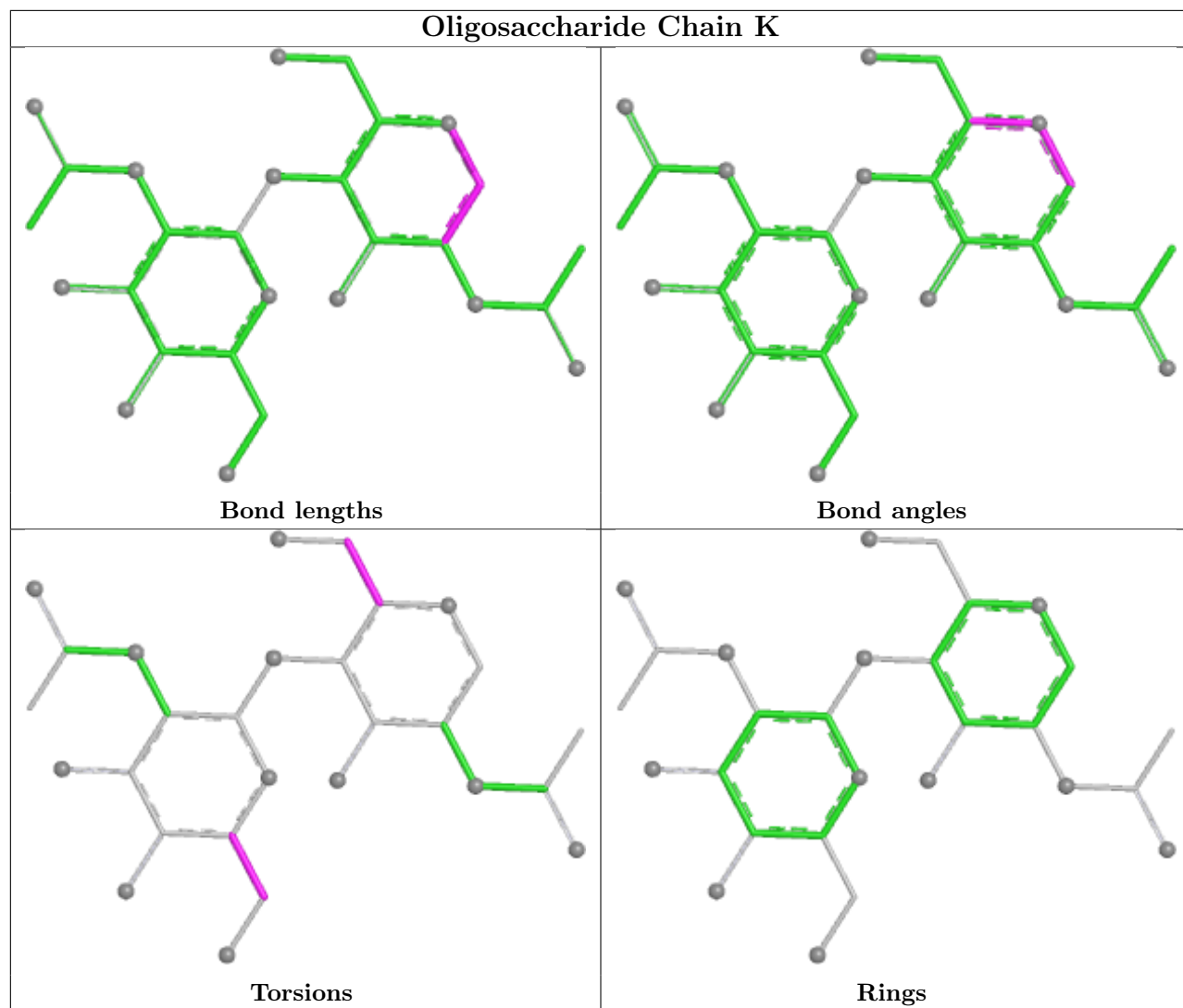

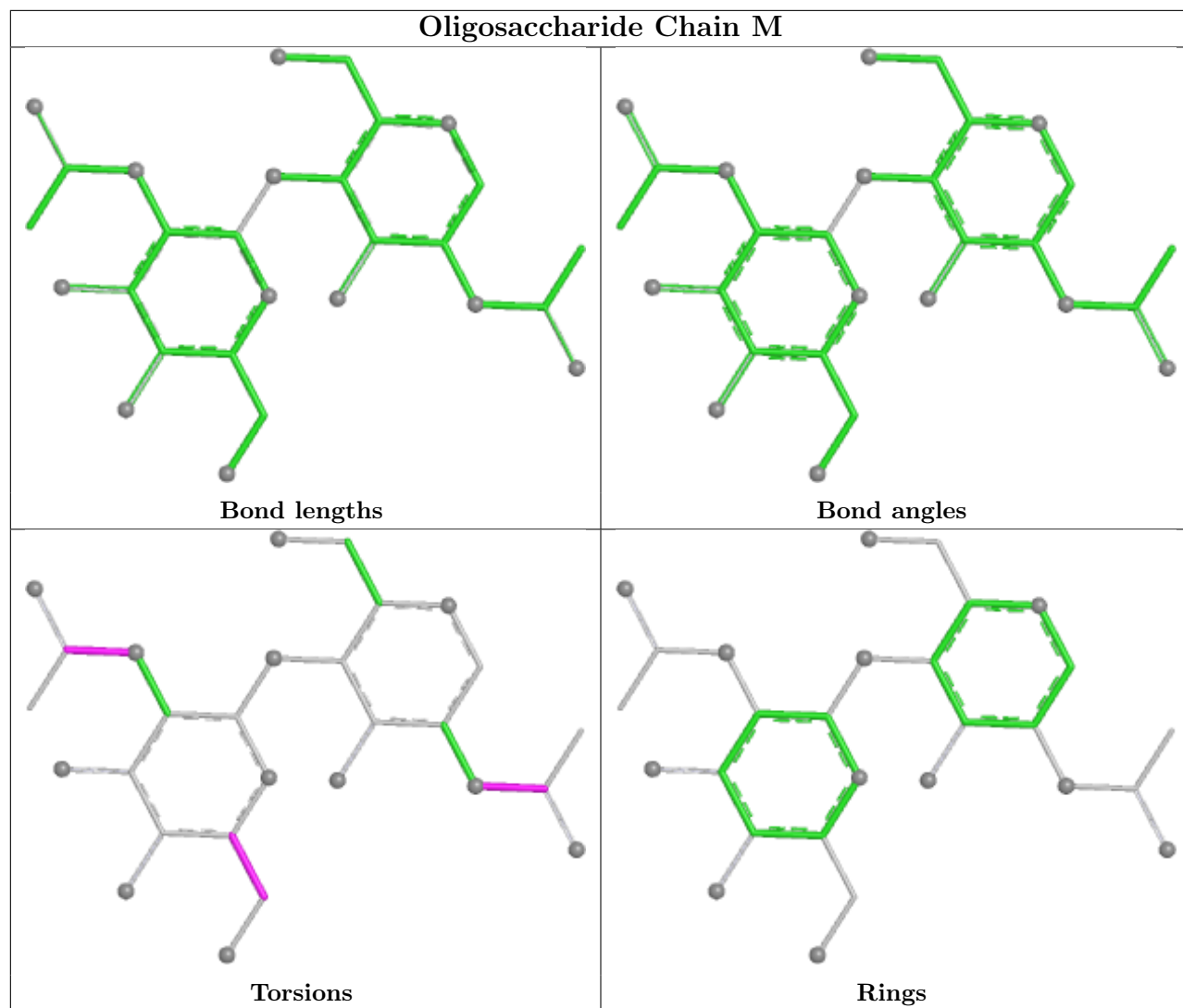

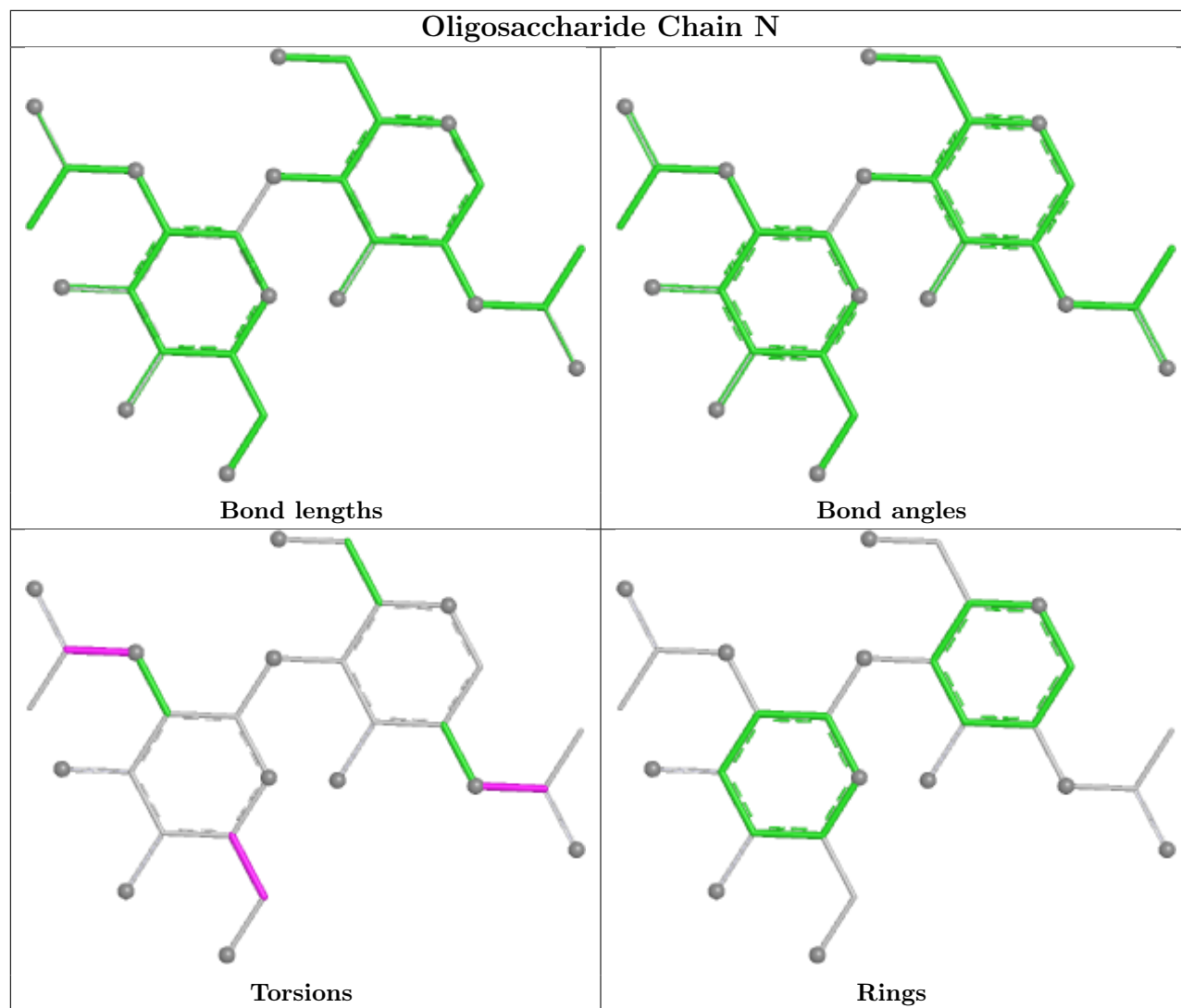

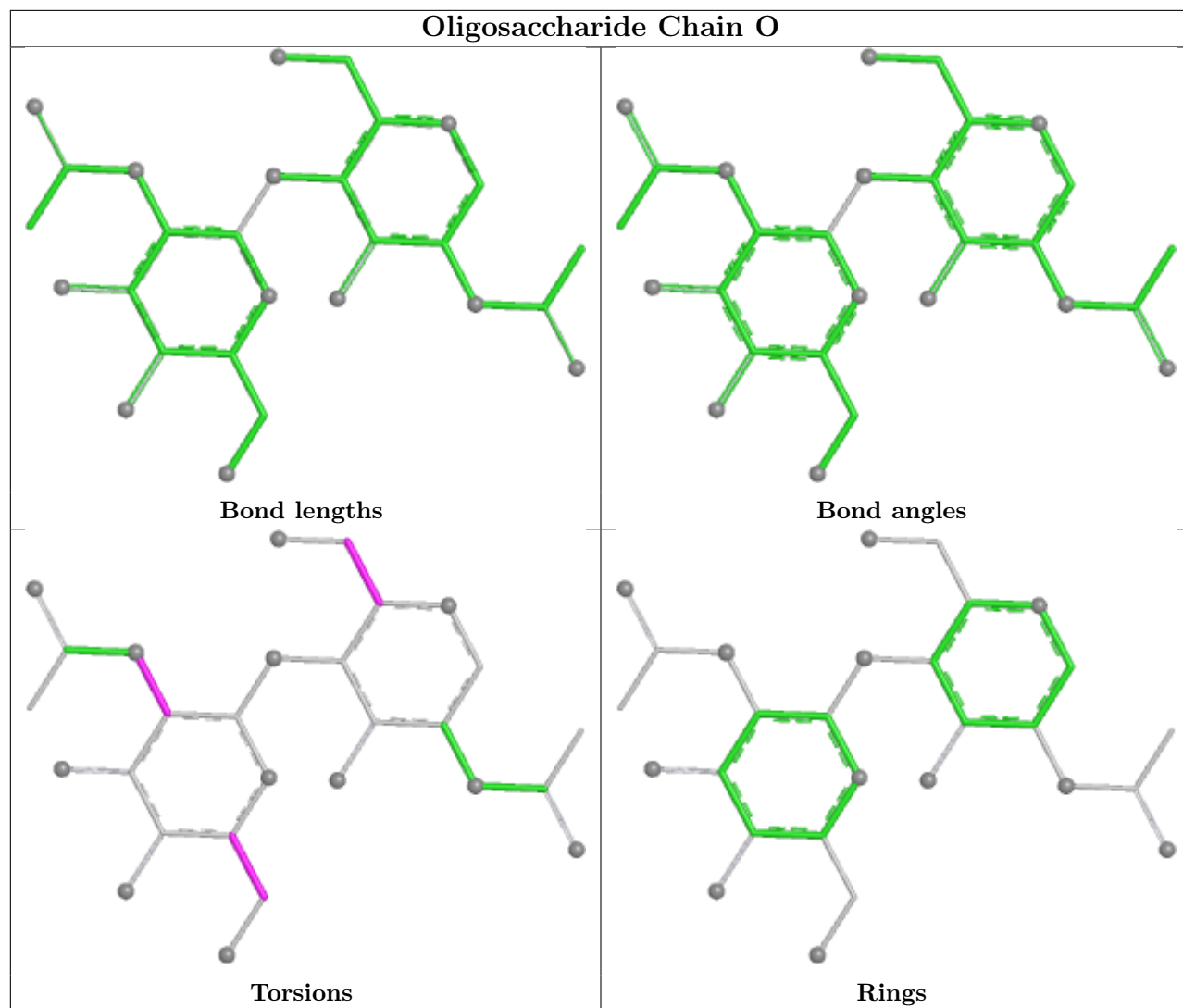

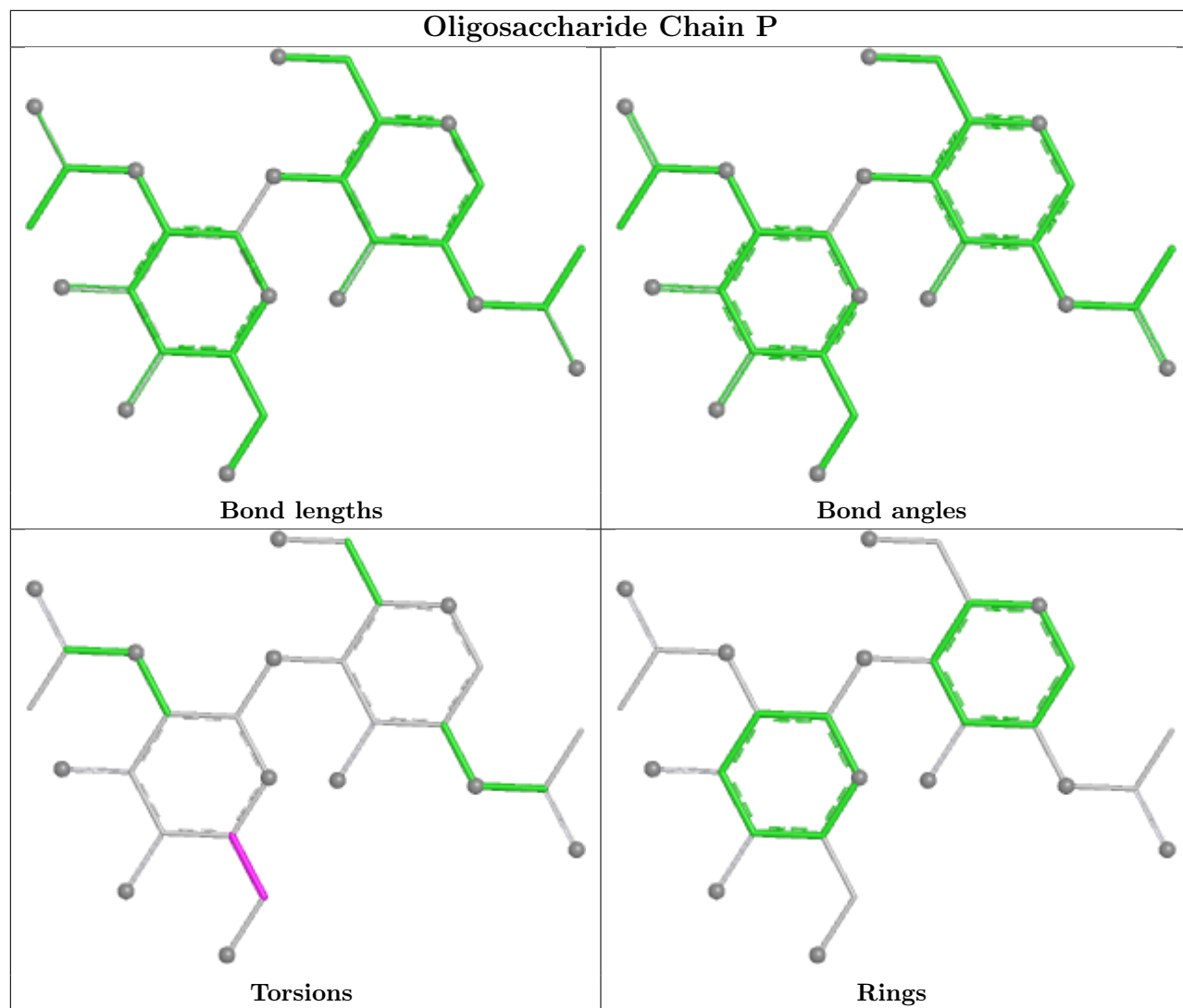

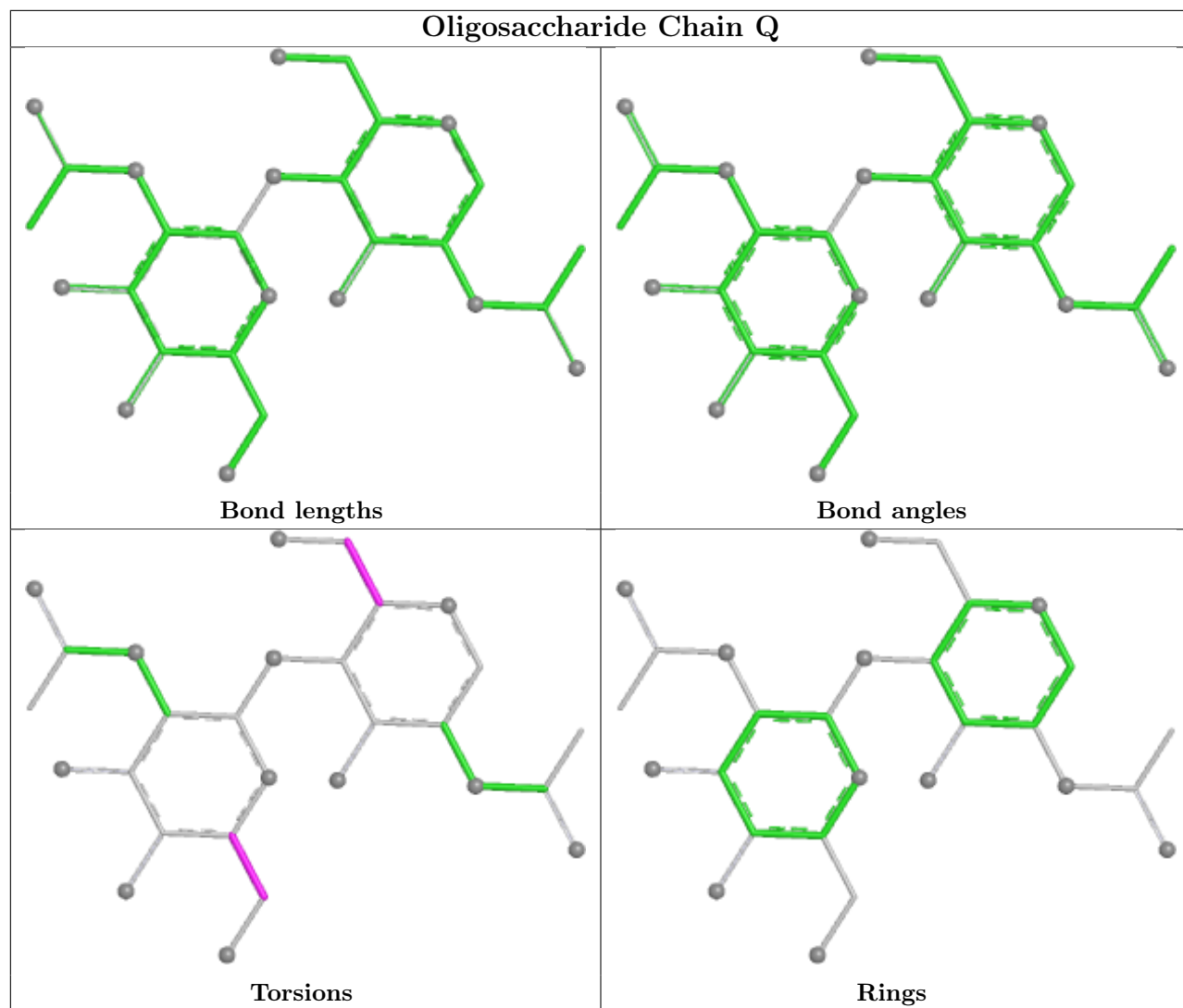

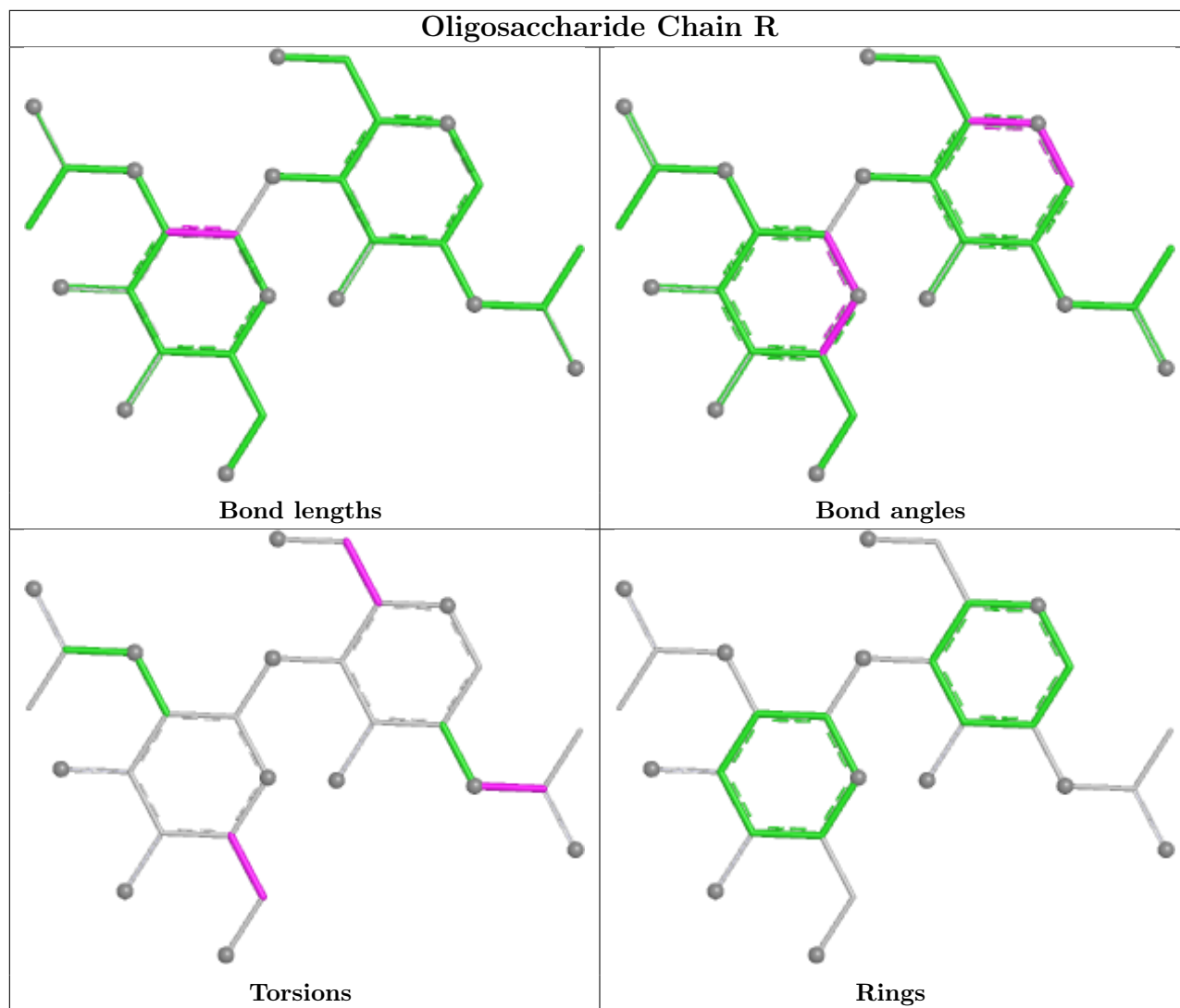

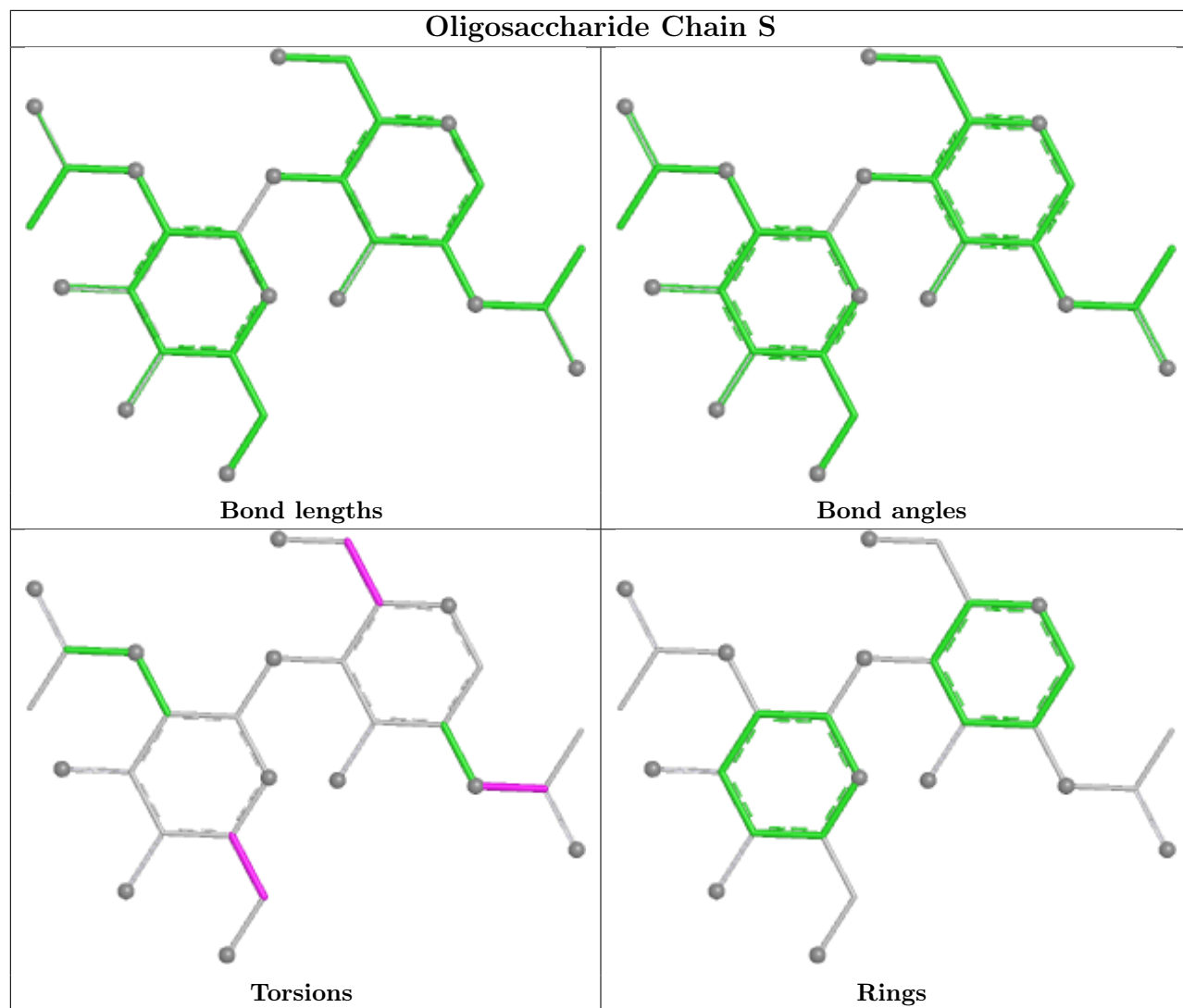

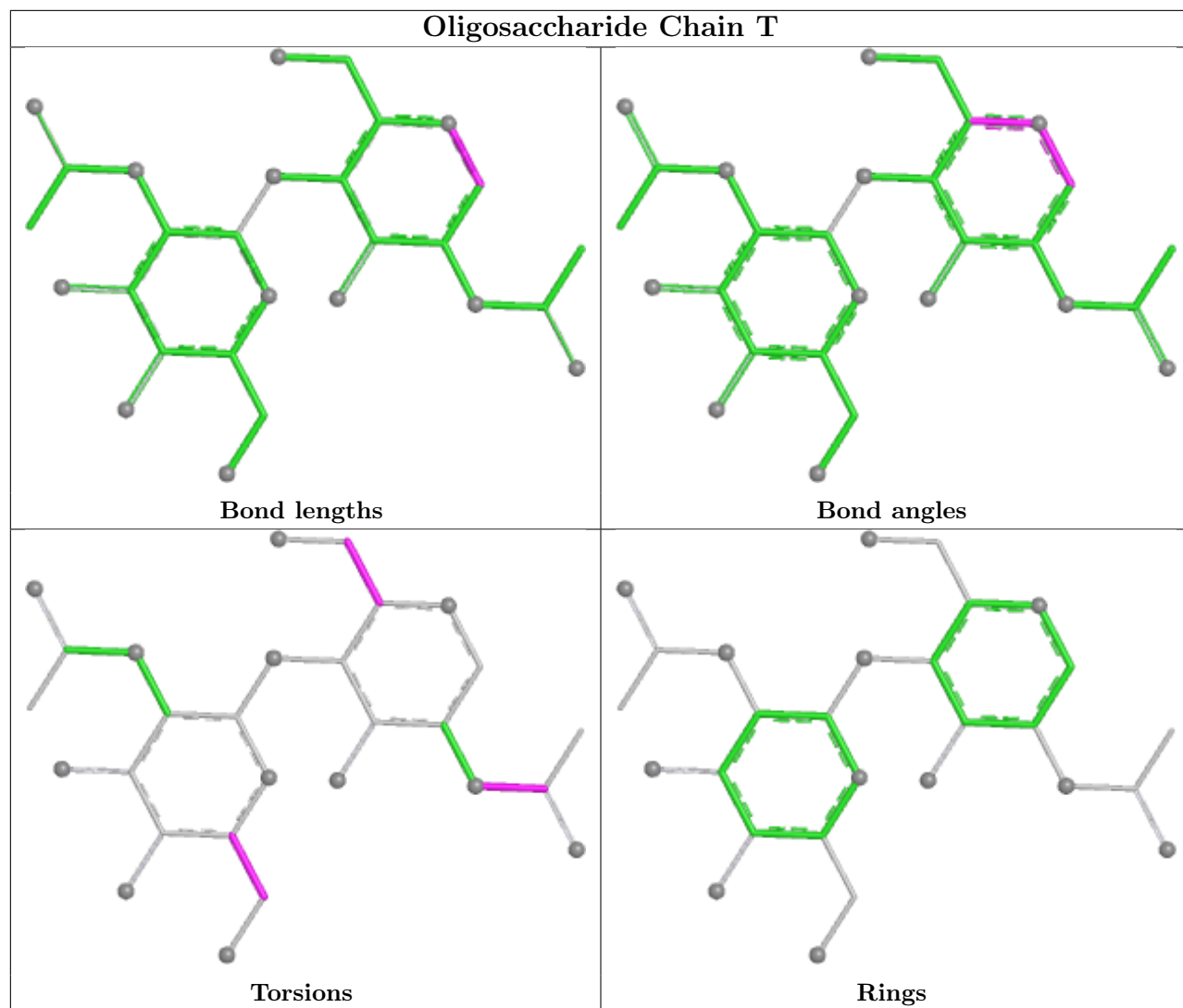

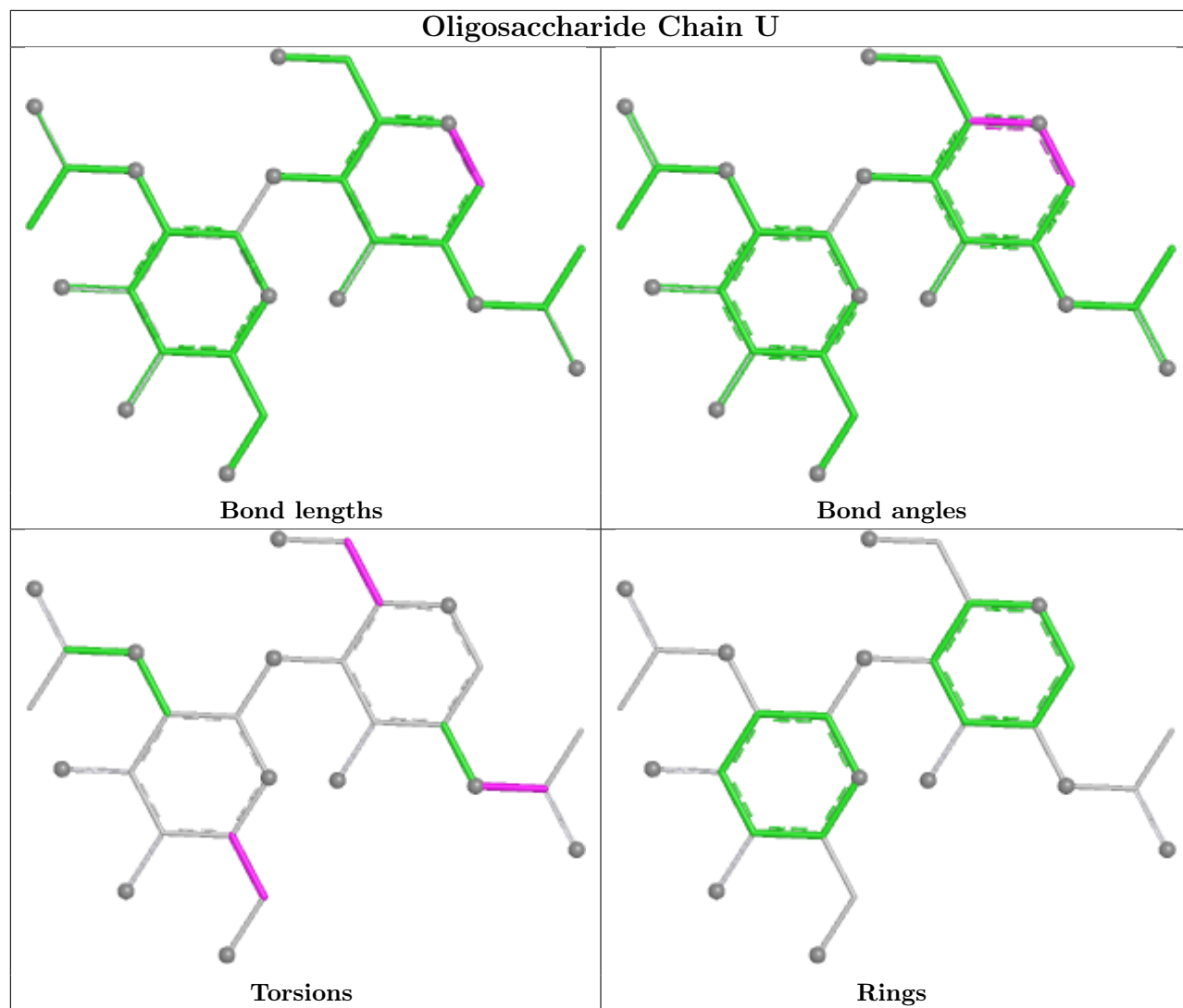

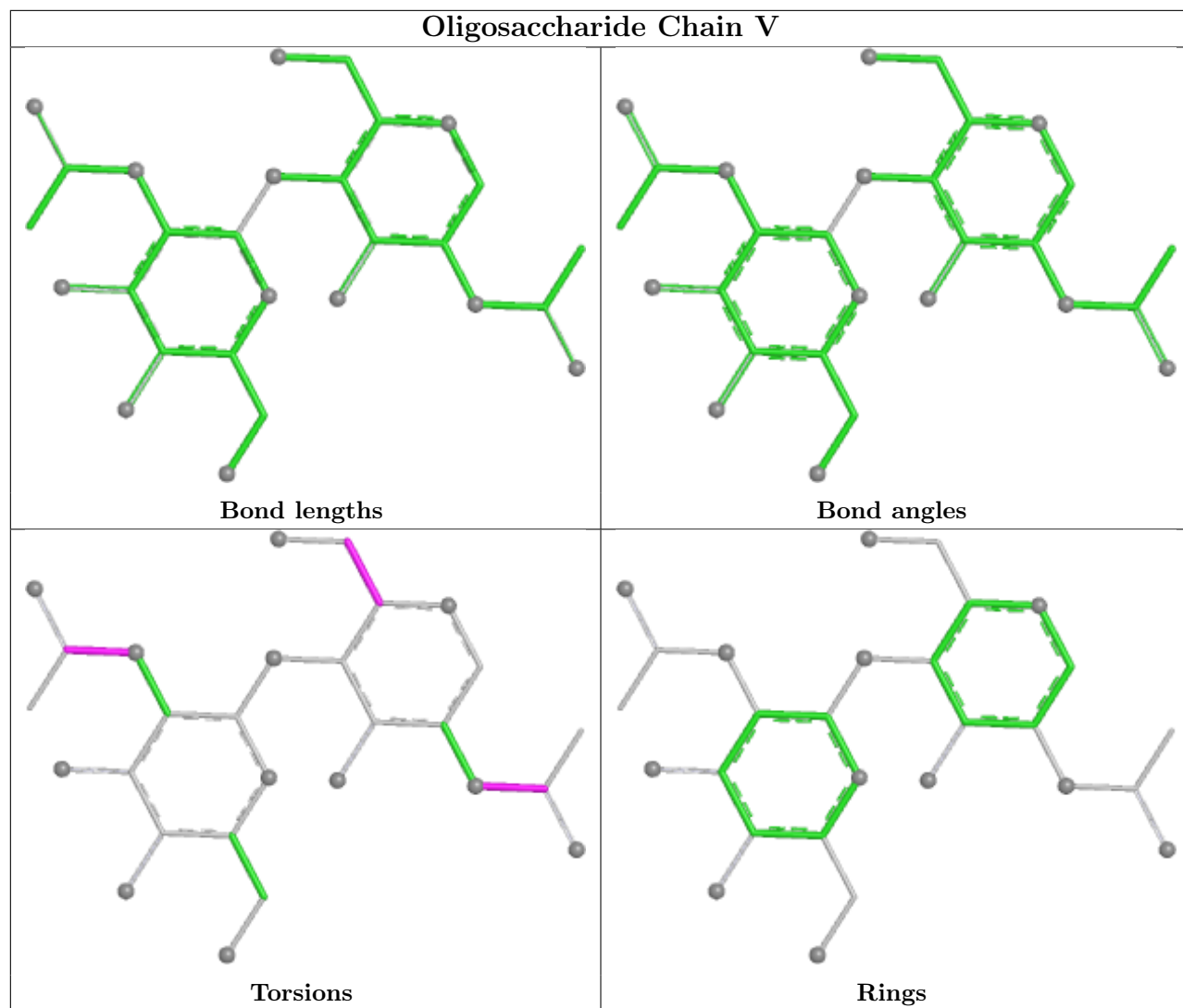

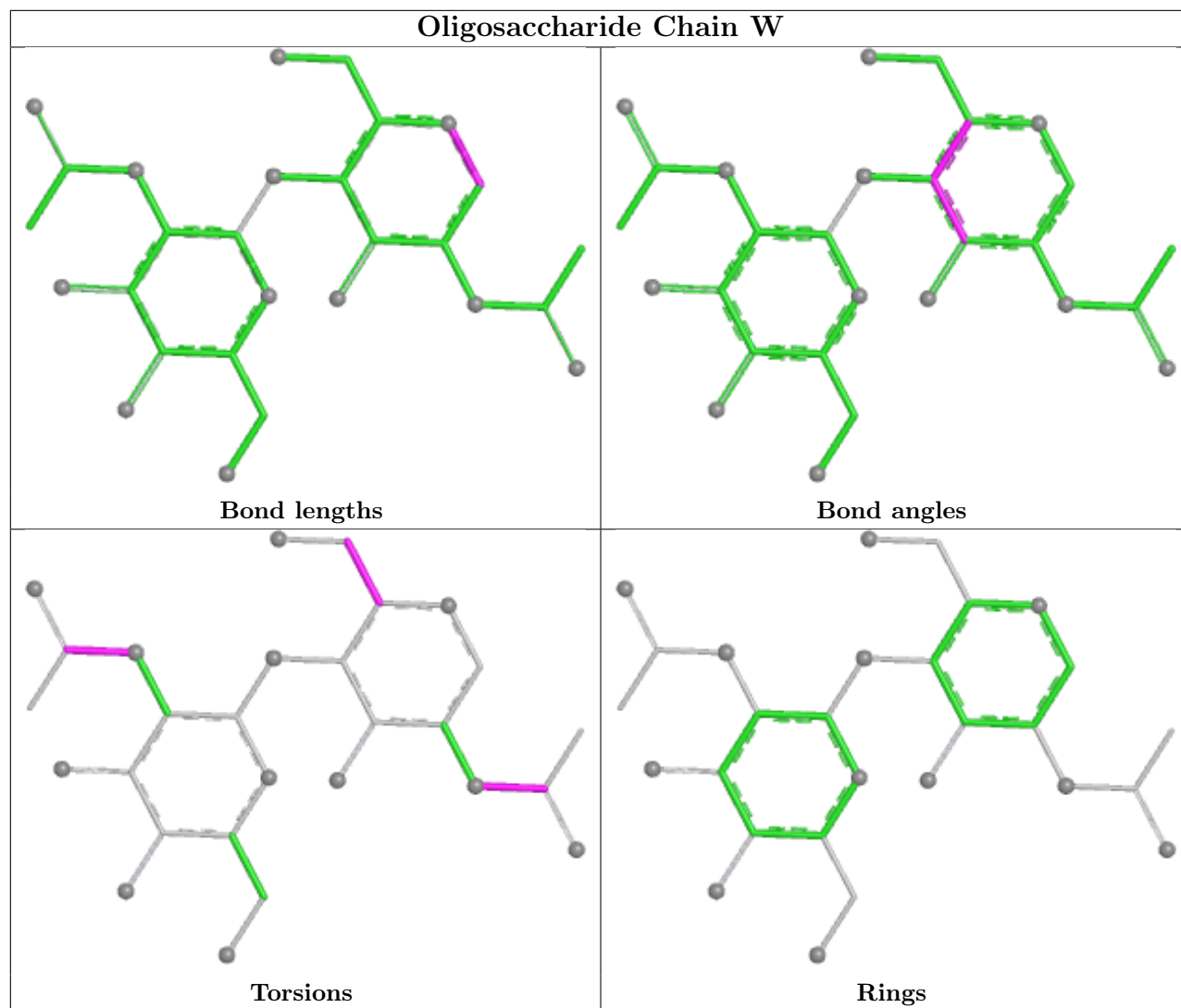

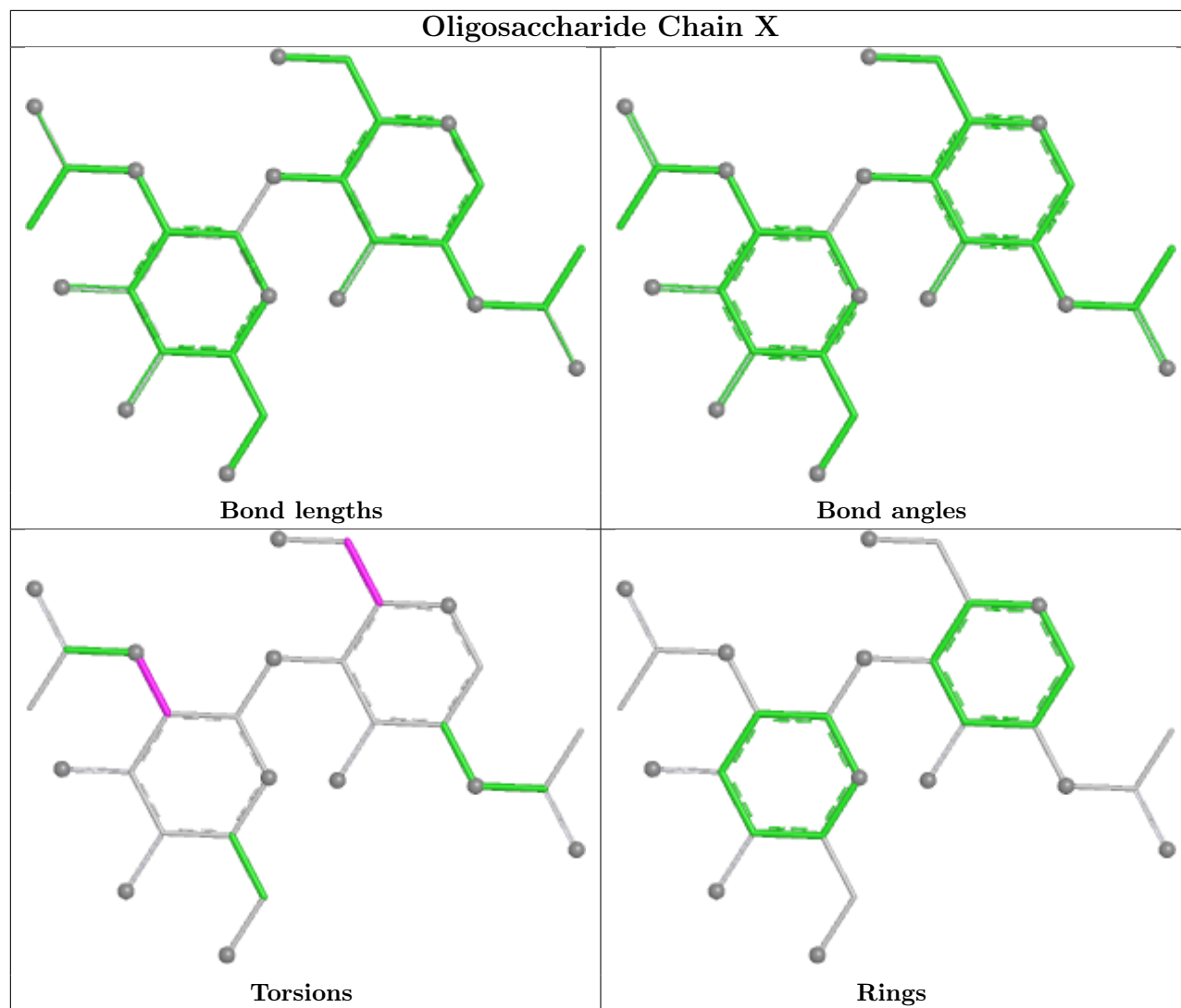

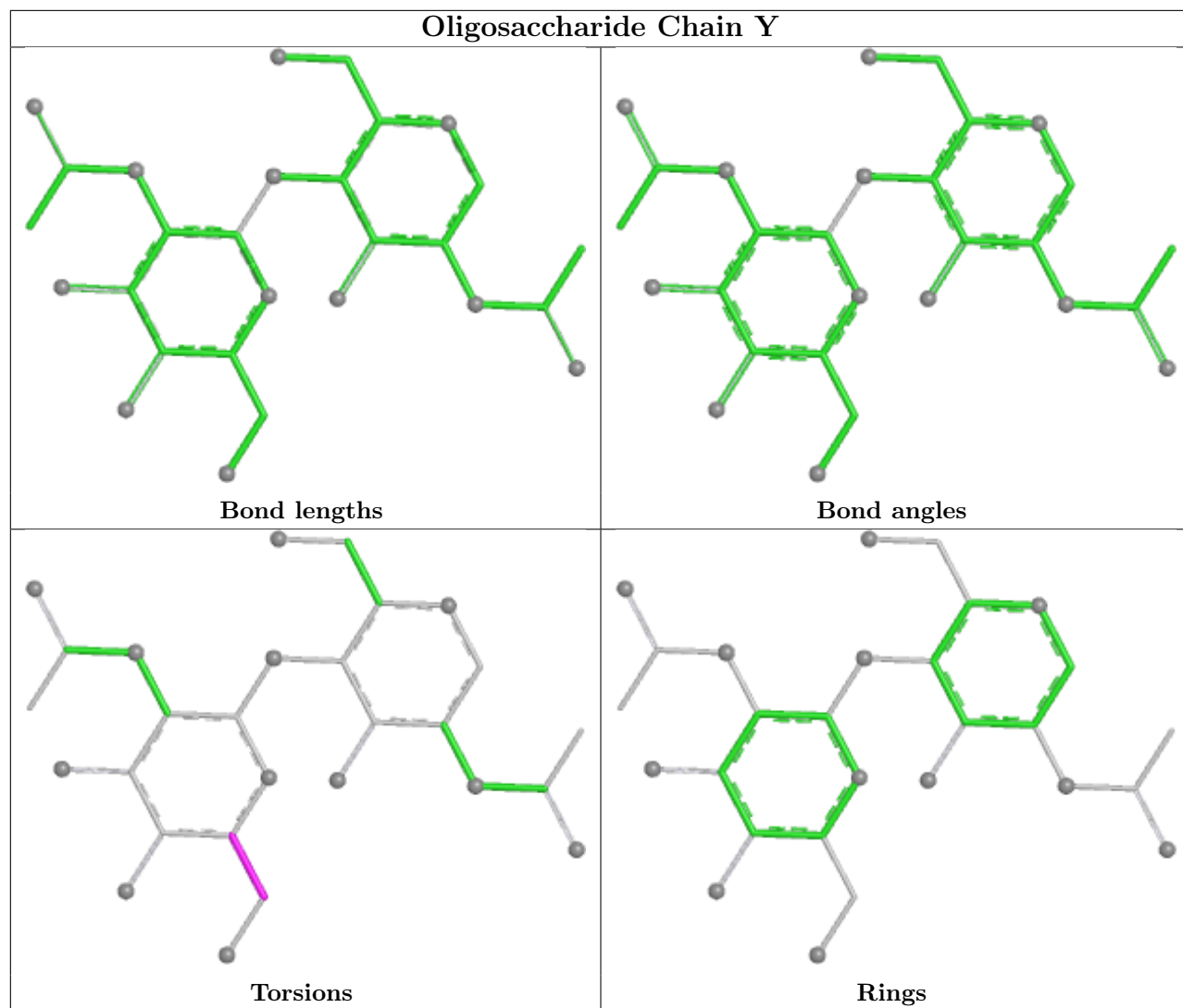

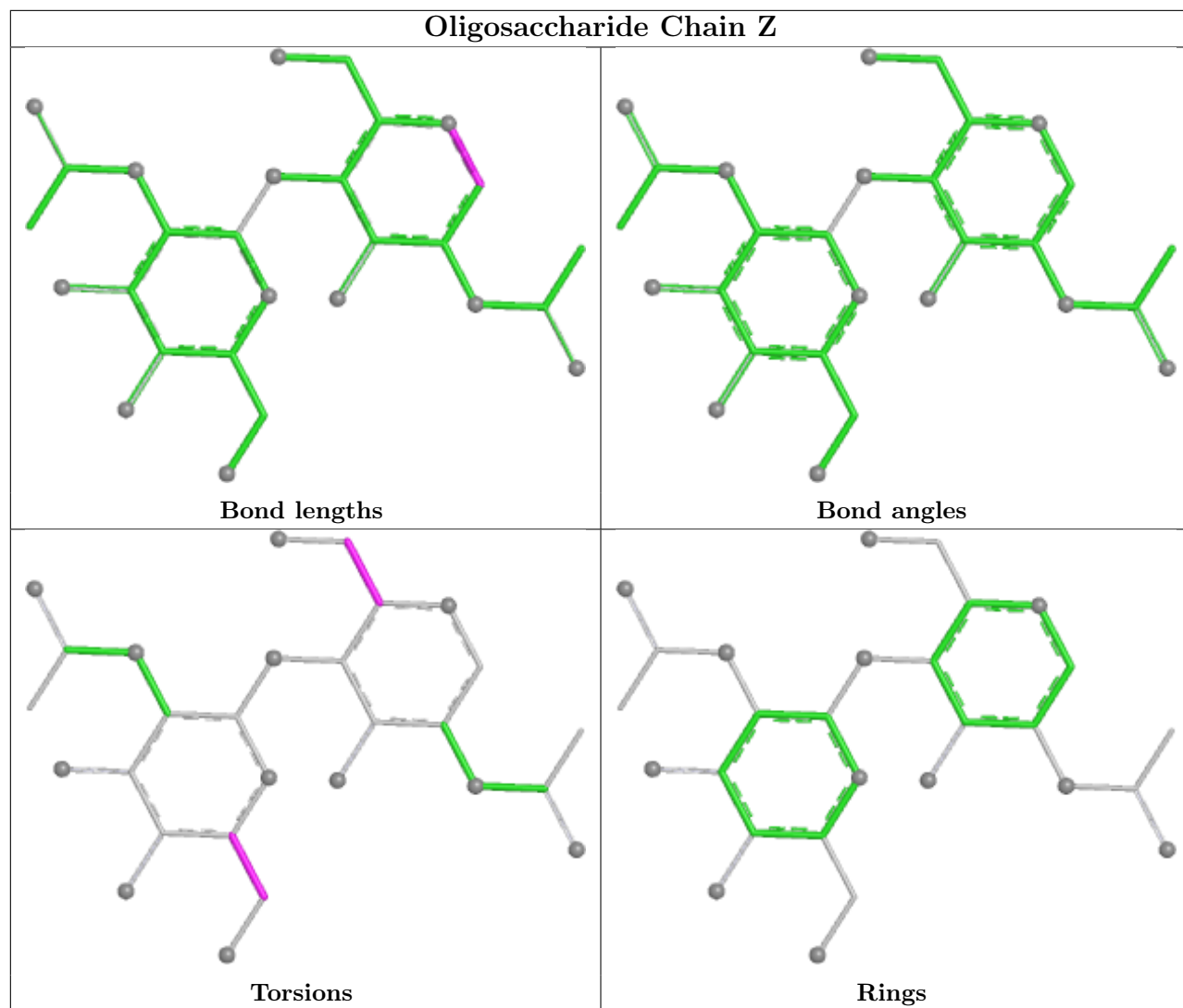

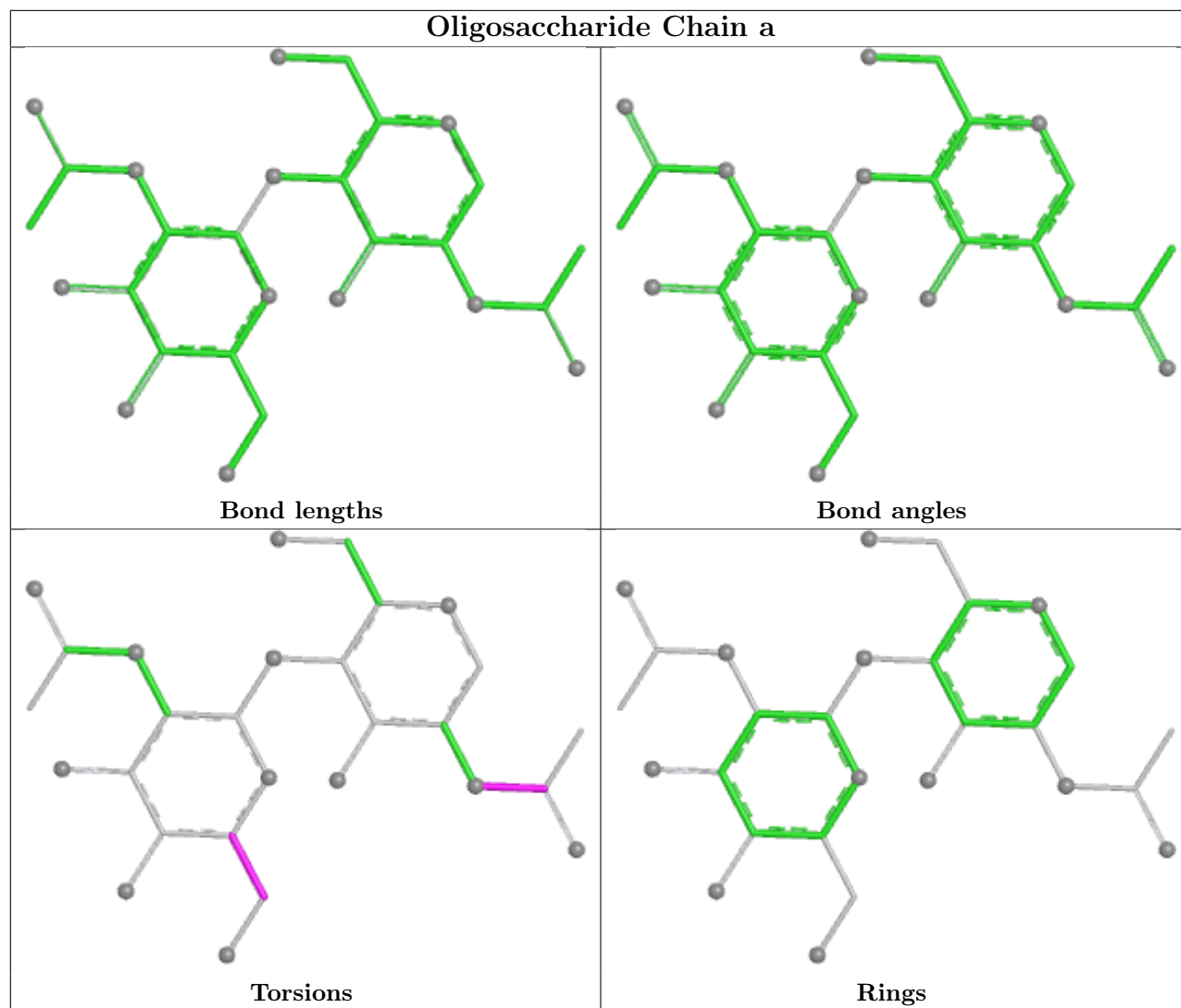

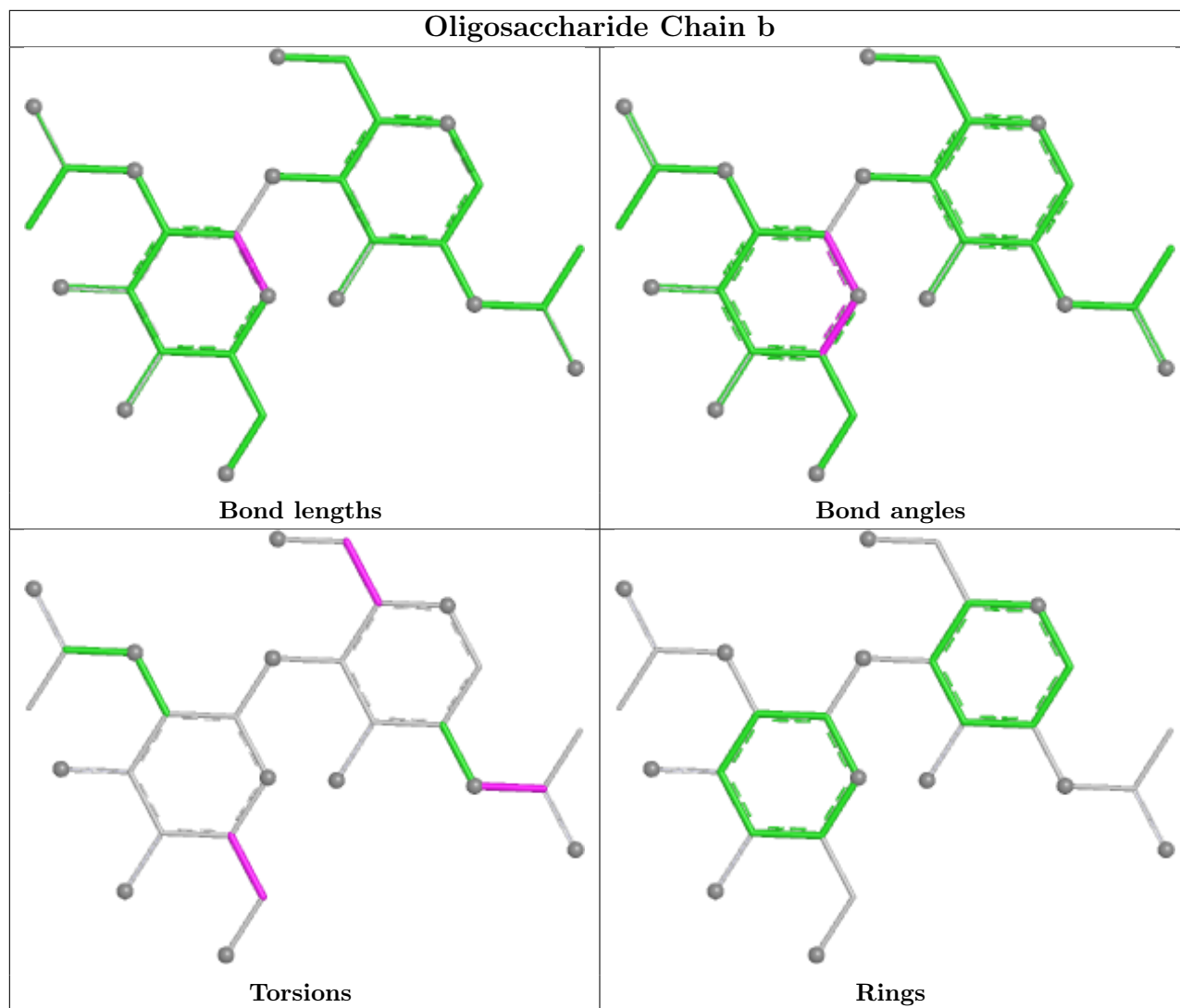

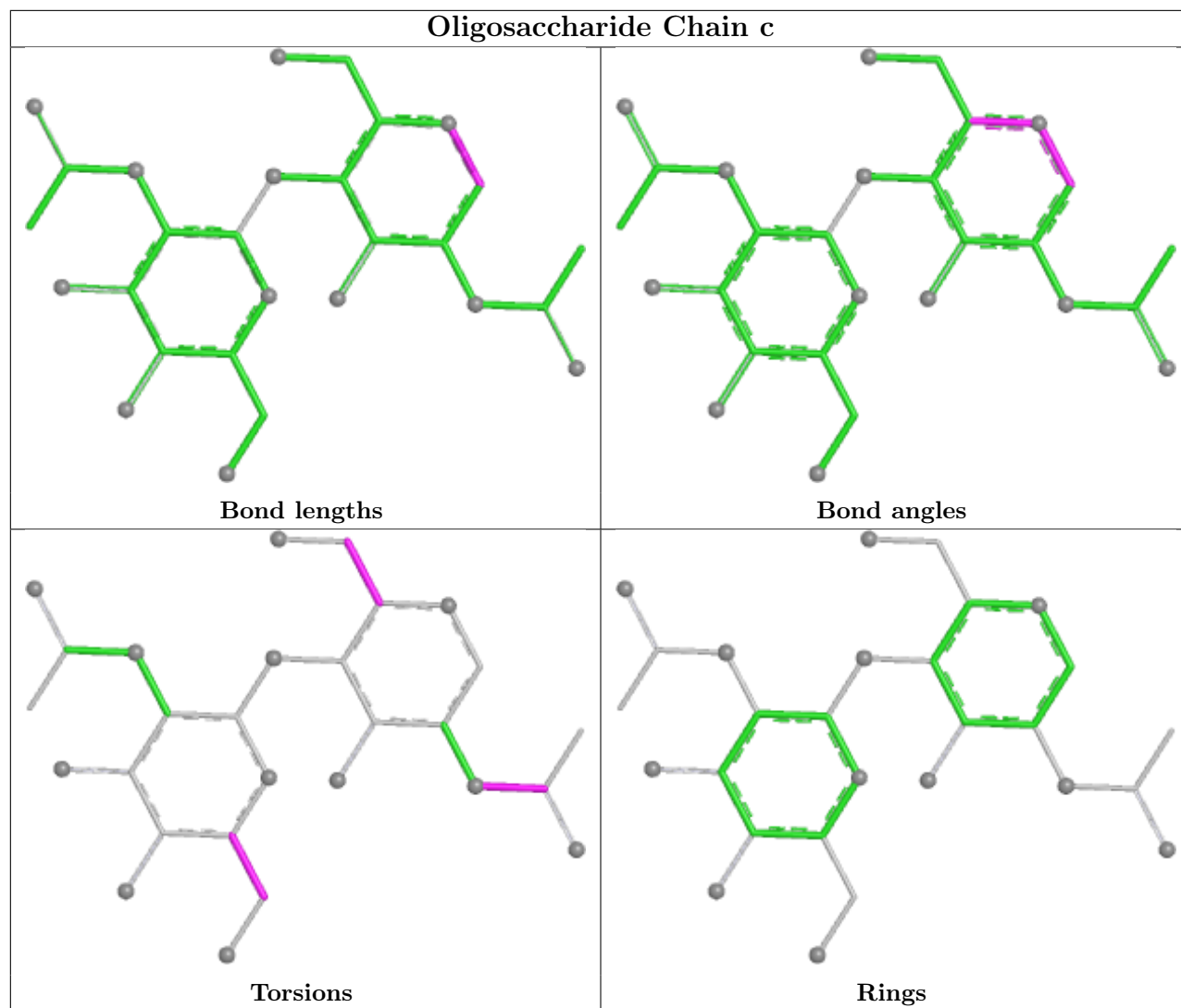

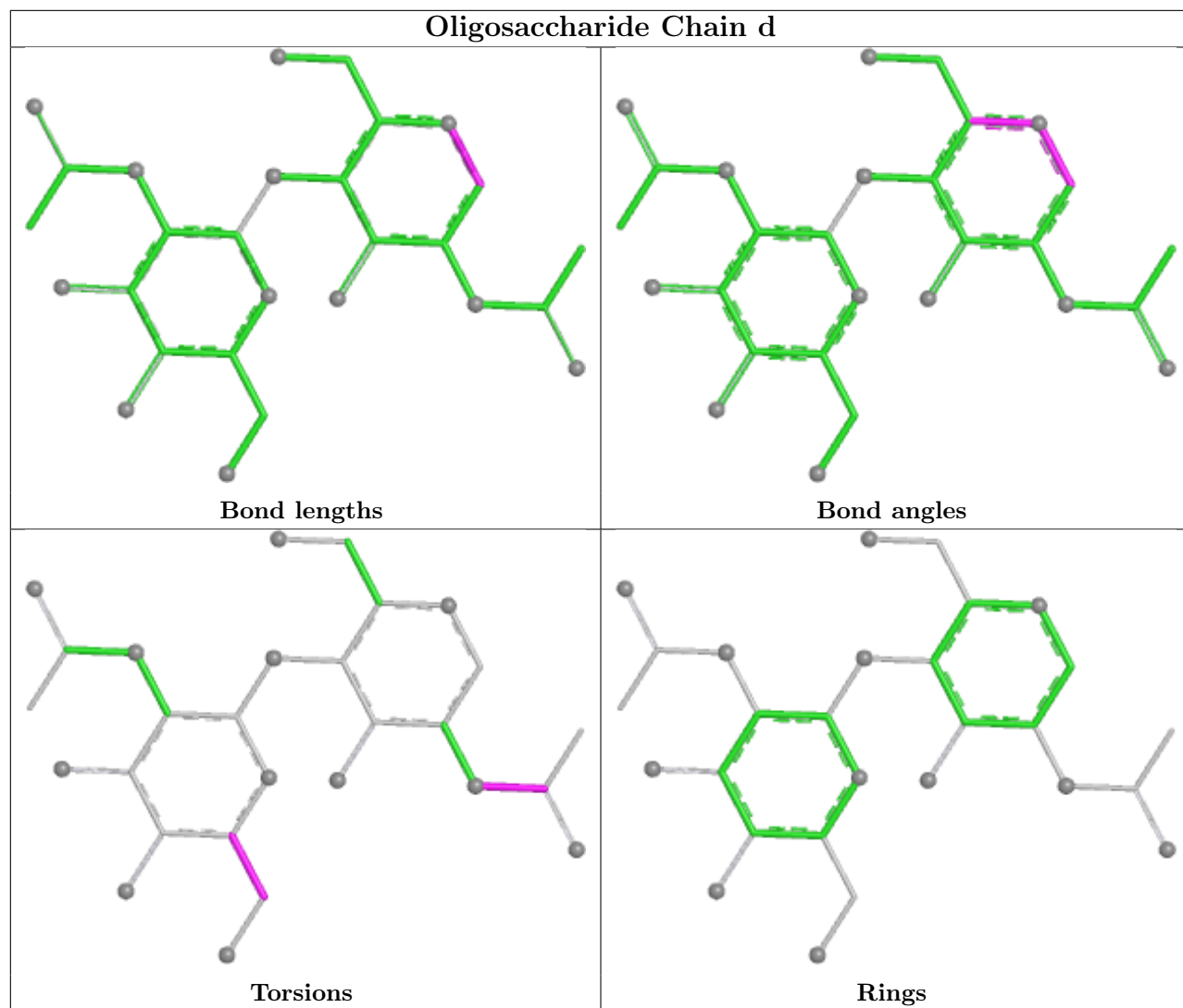

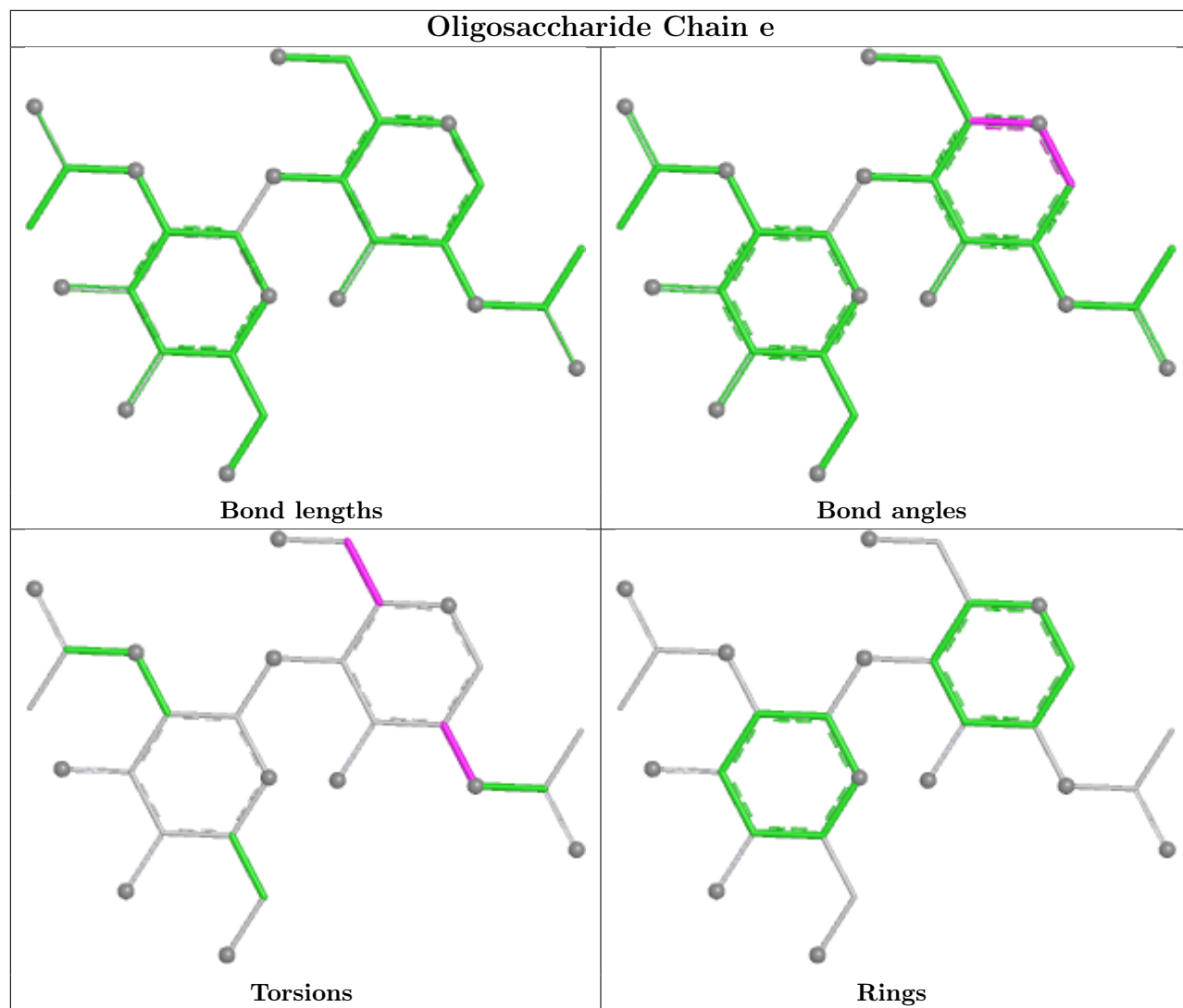

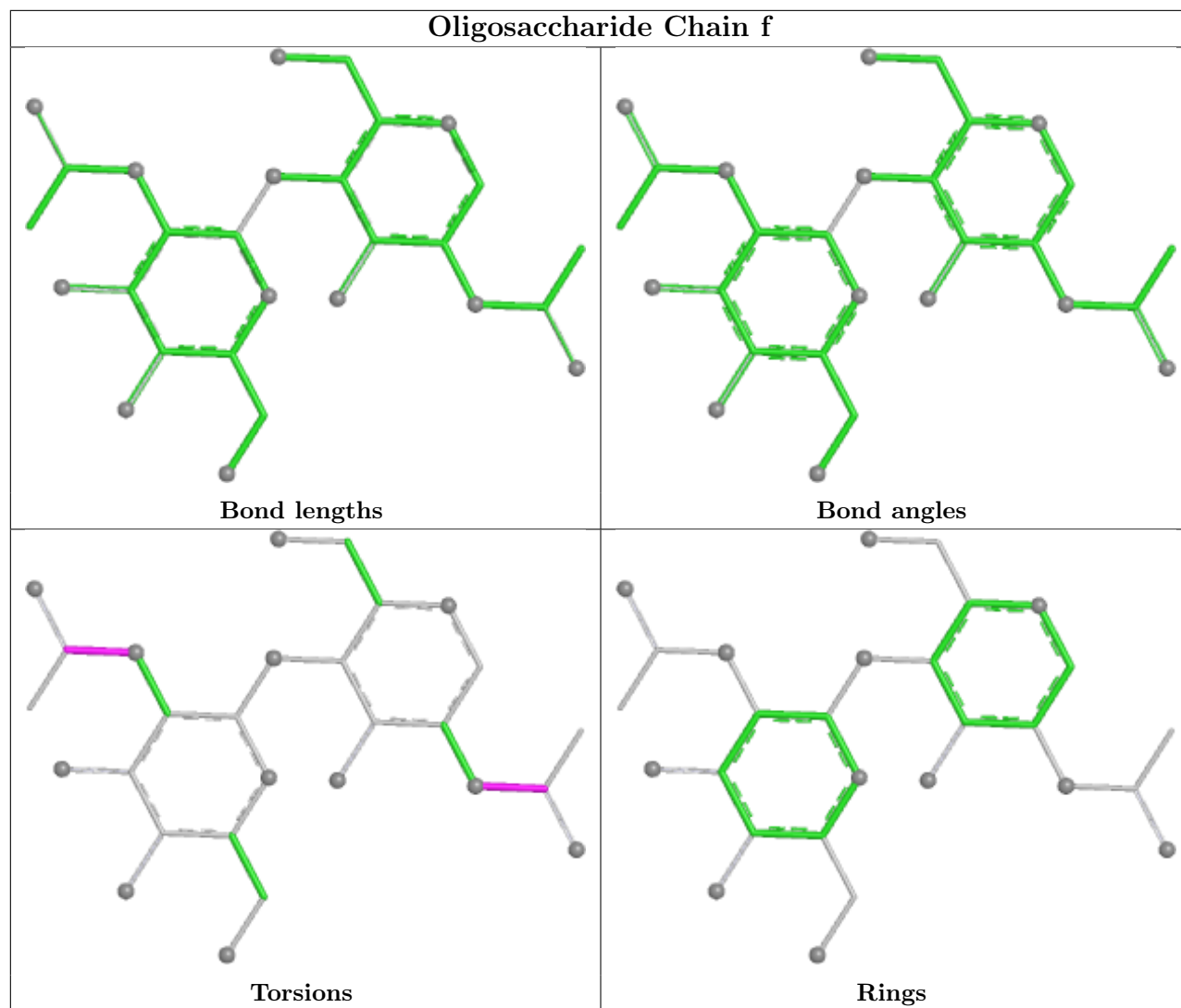

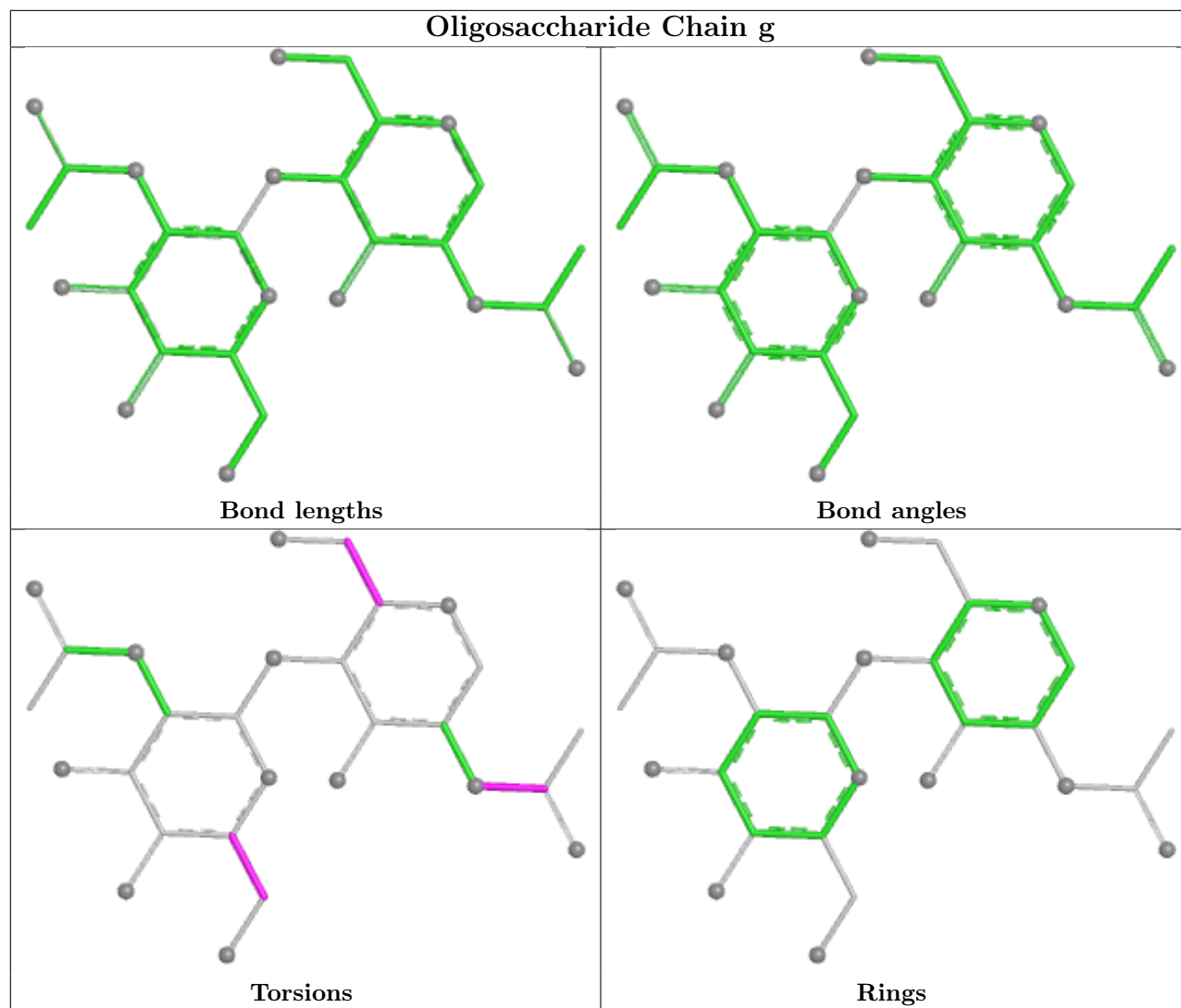

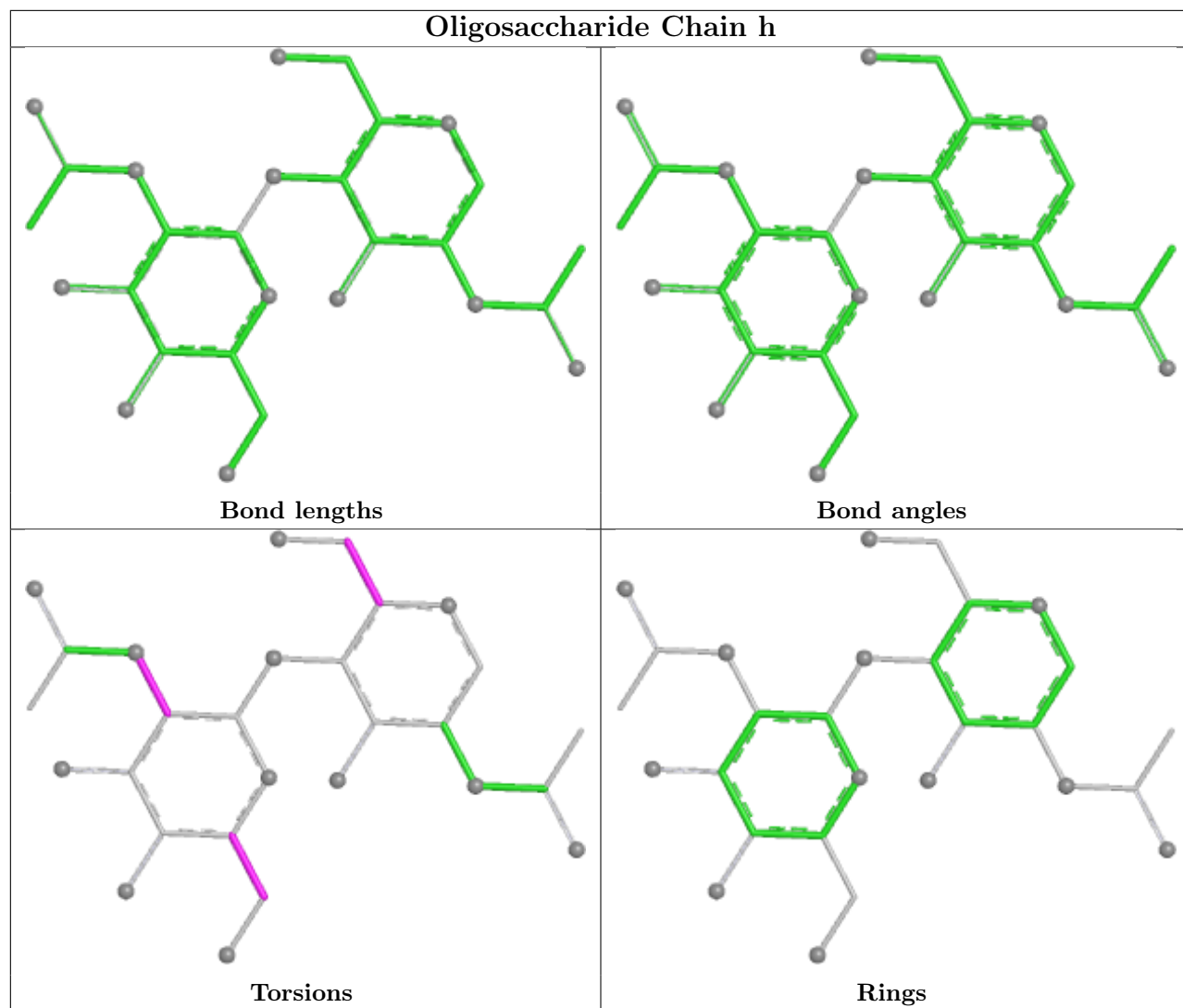

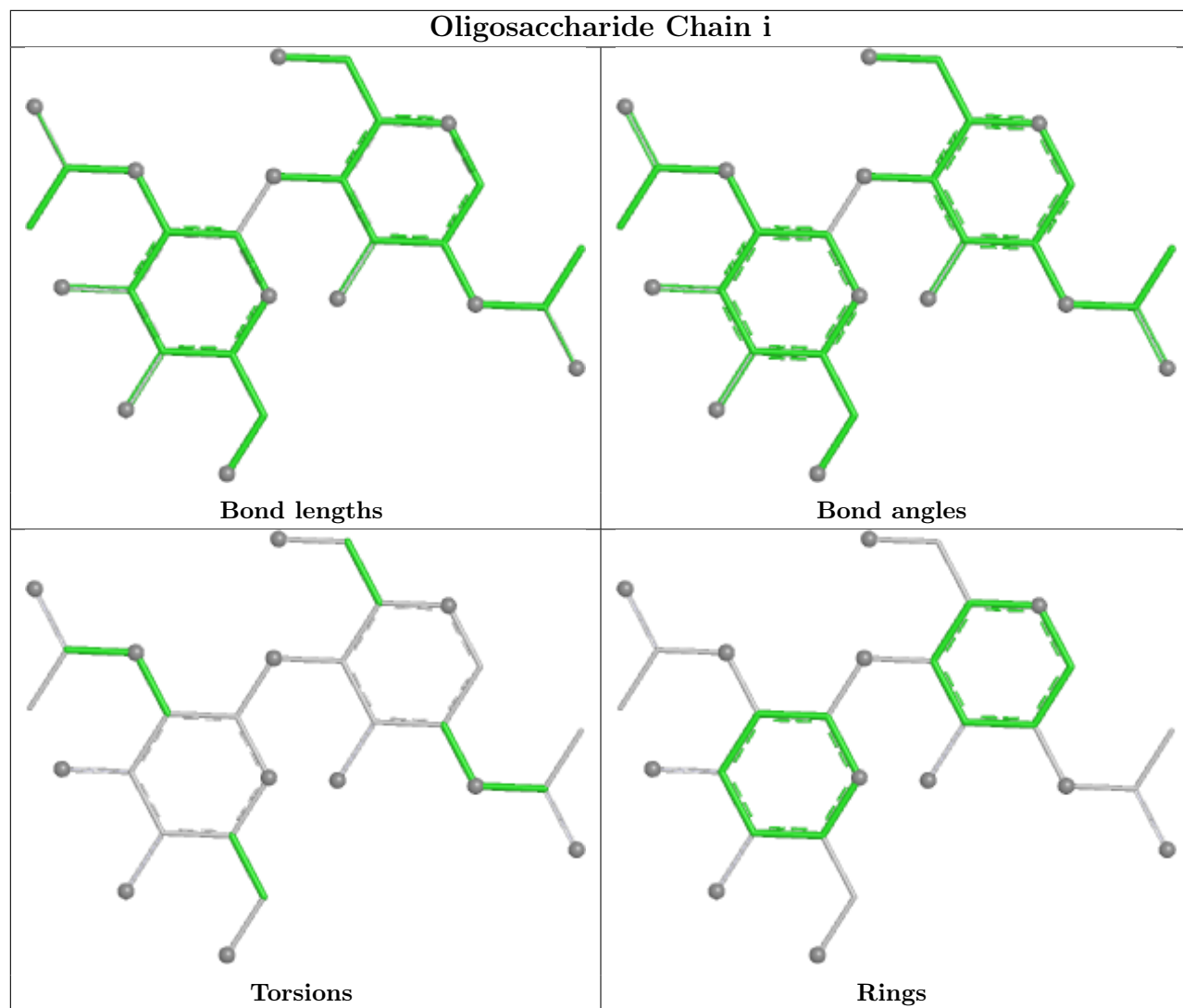

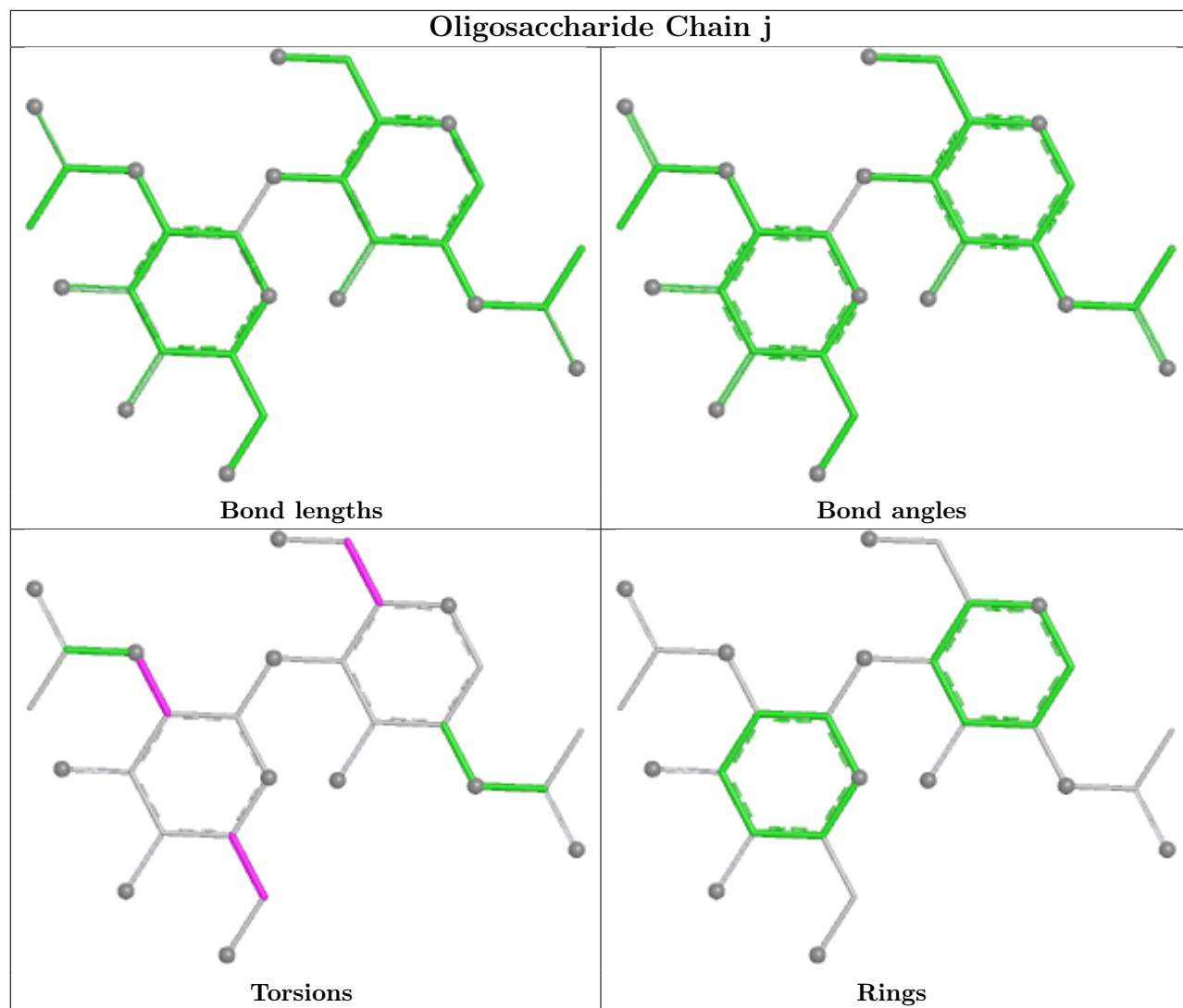

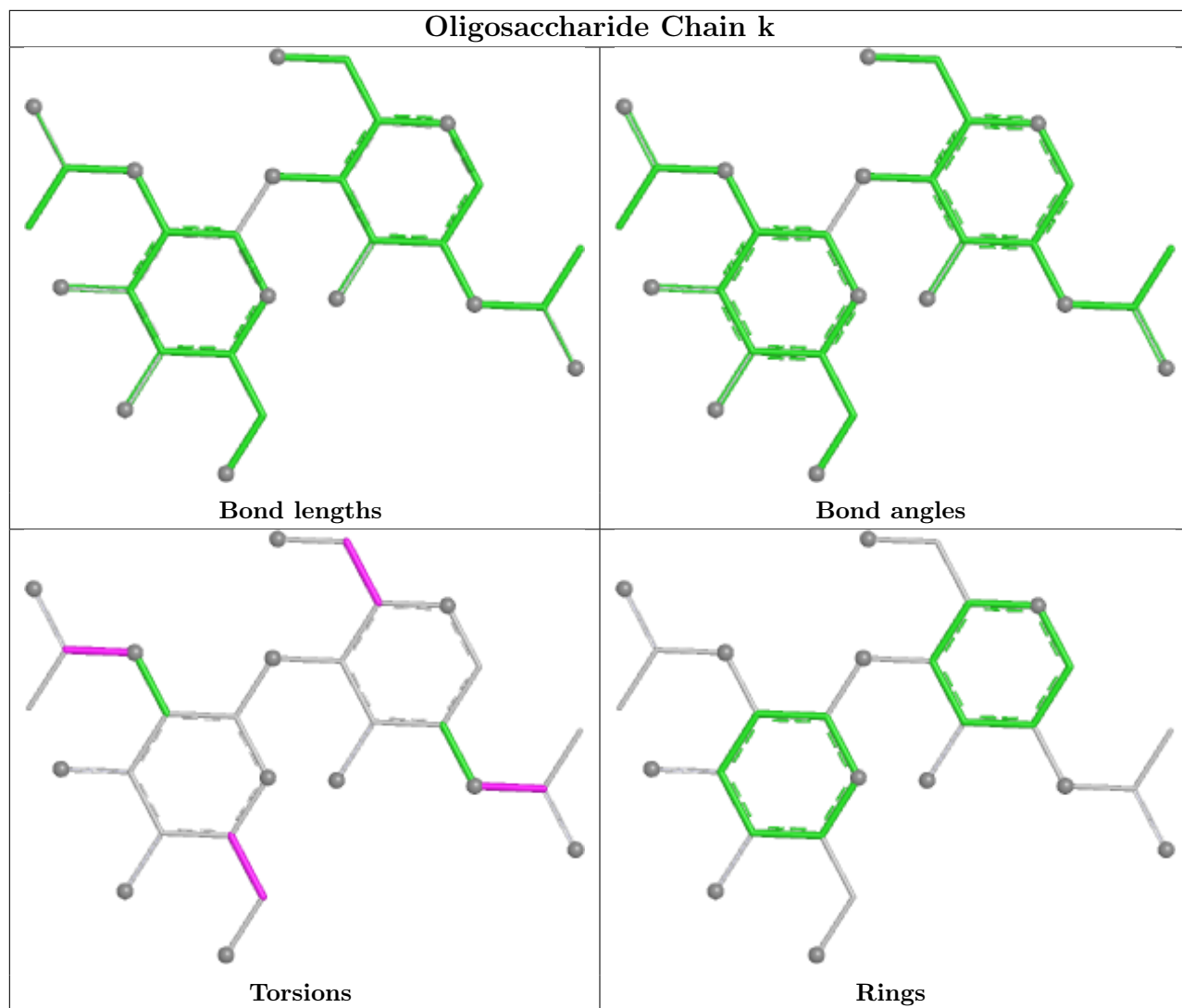

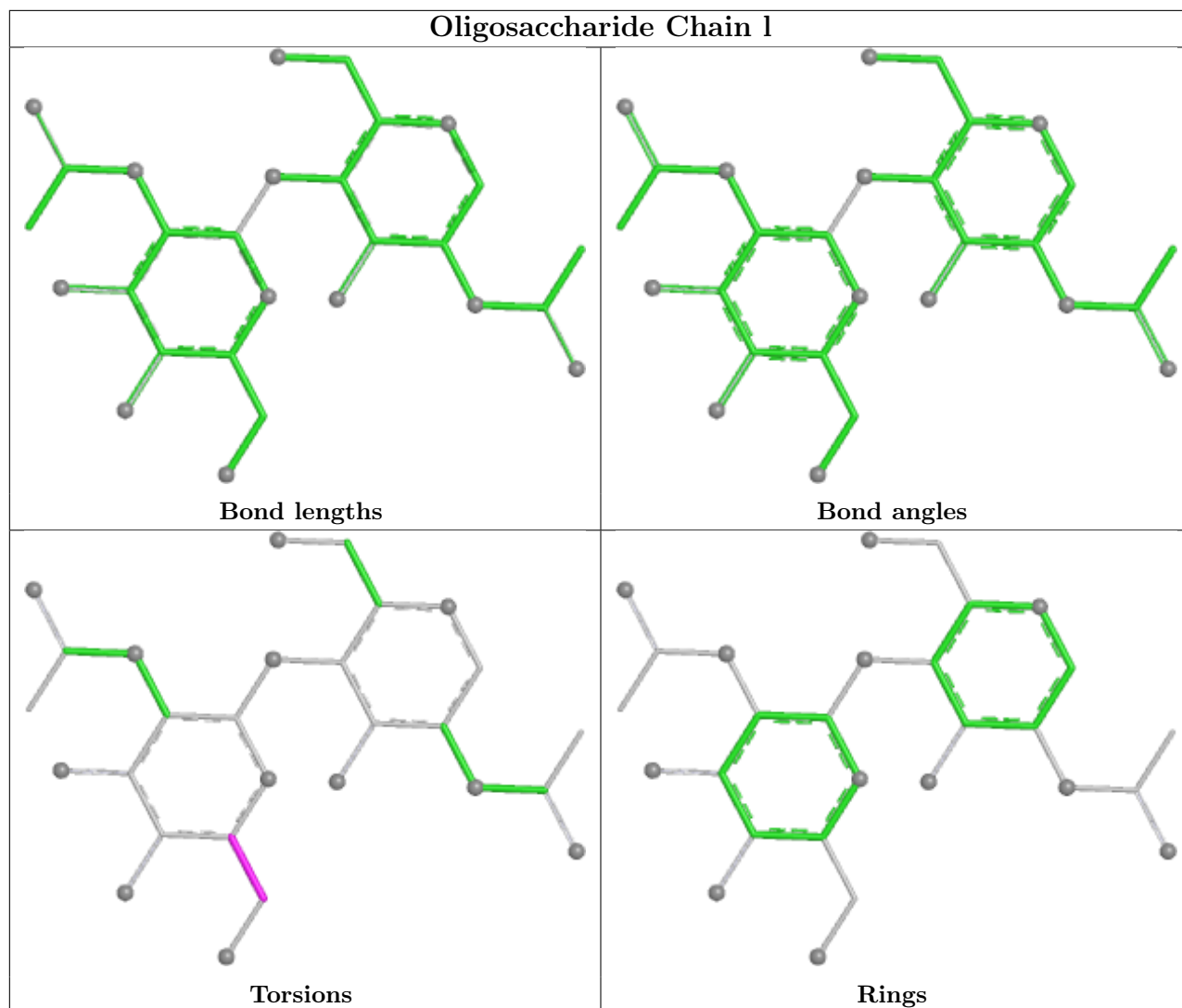

5.6 Ligand geometry [i](#)

25 ligands are modelled in this entry.

In the following table, the Counts columns list the number of bonds (or angles) for which Mogul statistics could be retrieved, the number of bonds (or angles) that are observed in the model and the number of bonds (or angles) that are defined in the Chemical Component Dictionary. The Link column lists molecule types, if any, to which the group is linked. The Z score for a bond length (or angle) is the number of standard deviations the observed value is removed from the expected value. A bond length (or angle) with $|Z| > 2$ is considered an outlier worth inspection. RMSZ is the root-mean-square of all Z scores of the bond lengths (or angles).

Mol	Type	Chain	Res	Link	Bond lengths			Bond angles		
					Counts	RMSZ	$\# Z > 2$	Counts	RMSZ	$\# Z > 2$
5	NAG	C	1308	3	14,14,15	0.26	0	17,19,21	0.50	0
5	NAG	A	1308	3	14,14,15	0.23	0	17,19,21	0.49	0
5	NAG	B	1306	3	14,14,15	0.42	0	17,19,21	0.37	0

Mol	Type	Chain	Res	Link	Bond lengths			Bond angles		
					Counts	RMSZ	# Z > 2	Counts	RMSZ	# Z > 2
5	NAG	B	1304	3	14,14,15	0.76	1 (7%)	17,19,21	0.94	1 (5%)
5	NAG	A	1306	-	14,14,15	0.72	1 (7%)	17,19,21	0.92	2 (11%)
5	NAG	C	1307	3	14,14,15	0.28	0	17,19,21	0.53	0
5	NAG	A	1301	3	14,14,15	0.35	0	17,19,21	0.54	0
5	NAG	C	1305	3	14,14,15	0.23	0	17,19,21	0.41	0
5	NAG	A	1304	3	14,14,15	1.30	1 (7%)	17,19,21	1.03	1 (5%)
5	NAG	B	1301	3	14,14,15	0.26	0	17,19,21	0.55	0
5	NAG	C	1306	-	14,14,15	0.62	0	17,19,21	0.78	1 (5%)
5	NAG	B	1308	3	14,14,15	0.29	0	17,19,21	0.53	0
5	NAG	A	1303	3	14,14,15	0.23	0	17,19,21	0.42	0
5	NAG	A	1302	3	14,14,15	0.48	0	17,19,21	0.51	0
5	NAG	C	1302	3	14,14,15	0.79	1 (7%)	17,19,21	0.96	1 (5%)
5	NAG	B	1309	3	14,14,15	0.31	0	17,19,21	0.49	0
5	NAG	A	1307	3	14,14,15	0.33	0	17,19,21	1.09	1 (5%)
5	NAG	C	1303	3	14,14,15	0.43	0	17,19,21	0.47	0
5	NAG	B	1305	3	14,14,15	0.92	1 (7%)	17,19,21	0.97	1 (5%)
5	NAG	B	1303	3	14,14,15	0.18	0	17,19,21	0.41	0
5	NAG	A	1305	3	14,14,15	0.22	0	17,19,21	0.44	0
5	NAG	B	1307	-	14,14,15	0.40	0	17,19,21	0.82	1 (5%)
5	NAG	C	1301	3	14,14,15	0.25	0	17,19,21	0.56	0
5	NAG	B	1302	3	14,14,15	0.86	1 (7%)	17,19,21	1.02	1 (5%)
5	NAG	C	1304	3	14,14,15	0.29	0	17,19,21	0.45	0

In the following table, the Chirals column lists the number of chiral outliers, the number of chiral centers analysed, the number of these observed in the model and the number defined in the Chemical Component Dictionary. Similar counts are reported in the Torsion and Rings columns. '-' means no outliers of that kind were identified.

Mol	Type	Chain	Res	Link	Chirals	Torsions	Rings
5	NAG	C	1308	3	-	4/6/23/26	0/1/1/1
5	NAG	A	1308	3	-	2/6/23/26	0/1/1/1
5	NAG	B	1306	3	-	2/6/23/26	0/1/1/1
5	NAG	B	1304	3	-	3/6/23/26	0/1/1/1
5	NAG	A	1306	-	-	1/6/23/26	0/1/1/1
5	NAG	C	1307	3	-	2/6/23/26	0/1/1/1
5	NAG	A	1301	3	-	4/6/23/26	0/1/1/1
5	NAG	C	1305	3	-	2/6/23/26	0/1/1/1
5	NAG	A	1304	3	-	1/6/23/26	0/1/1/1
5	NAG	B	1301	3	-	4/6/23/26	0/1/1/1

Continued on next page...

Continued from previous page...

Mol	Type	Chain	Res	Link	Chirals	Torsions	Rings
5	NAG	C	1306	-	-	1/6/23/26	0/1/1/1
5	NAG	B	1308	3	-	2/6/23/26	0/1/1/1
5	NAG	A	1303	3	-	4/6/23/26	0/1/1/1
5	NAG	A	1302	3	-	2/6/23/26	0/1/1/1
5	NAG	C	1302	3	-	2/6/23/26	0/1/1/1
5	NAG	B	1309	3	-	2/6/23/26	0/1/1/1
5	NAG	A	1307	3	-	0/6/23/26	0/1/1/1
5	NAG	C	1303	3	-	2/6/23/26	0/1/1/1
5	NAG	B	1305	3	-	4/6/23/26	0/1/1/1
5	NAG	B	1303	3	-	2/6/23/26	0/1/1/1
5	NAG	A	1305	3	-	3/6/23/26	0/1/1/1
5	NAG	B	1307	-	-	1/6/23/26	0/1/1/1
5	NAG	C	1301	3	-	2/6/23/26	0/1/1/1
5	NAG	B	1302	3	-	4/6/23/26	0/1/1/1
5	NAG	C	1304	3	-	2/6/23/26	0/1/1/1

All (6) bond length outliers are listed below:

Mol	Chain	Res	Type	Atoms	Z	Observed(Å)	Ideal(Å)
5	A	1304	NAG	O5-C1	4.52	1.51	1.43
5	B	1305	NAG	O5-C1	3.18	1.49	1.43
5	B	1302	NAG	O5-C1	2.80	1.48	1.43
5	C	1302	NAG	O5-C1	2.47	1.47	1.43
5	A	1306	NAG	O5-C1	-2.43	1.39	1.43
5	B	1304	NAG	O5-C1	2.38	1.47	1.43

All (10) bond angle outliers are listed below:

Mol	Chain	Res	Type	Atoms	Z	Observed(°)	Ideal(°)
5	A	1304	NAG	C1-O5-C5	4.02	117.58	112.19
5	B	1302	NAG	C1-O5-C5	3.92	117.43	112.19
5	C	1302	NAG	C1-O5-C5	3.72	117.17	112.19
5	B	1305	NAG	C1-O5-C5	3.65	117.07	112.19
5	B	1304	NAG	C1-O5-C5	3.63	117.05	112.19
5	A	1307	NAG	C1-O5-C5	3.55	116.95	112.19
5	B	1307	NAG	C1-O5-C5	3.04	116.25	112.19
5	C	1306	NAG	C1-O5-C5	2.91	116.09	112.19
5	A	1306	NAG	C1-O5-C5	2.36	115.35	112.19
5	A	1306	NAG	C3-C4-C5	2.20	114.23	110.23

There are no chirality outliers.

All (58) torsion outliers are listed below:

Mol	Chain	Res	Type	Atoms
5	B	1308	NAG	C4-C5-C6-O6
5	B	1302	NAG	C4-C5-C6-O6
5	B	1308	NAG	O5-C5-C6-O6
5	A	1302	NAG	C4-C5-C6-O6
5	A	1308	NAG	O5-C5-C6-O6
5	B	1309	NAG	O5-C5-C6-O6
5	A	1302	NAG	O5-C5-C6-O6
5	B	1302	NAG	O5-C5-C6-O6
5	C	1307	NAG	C4-C5-C6-O6
5	C	1307	NAG	O5-C5-C6-O6
5	B	1304	NAG	O5-C5-C6-O6
5	C	1302	NAG	C4-C5-C6-O6
5	A	1301	NAG	O5-C5-C6-O6
5	C	1302	NAG	O5-C5-C6-O6
5	A	1308	NAG	C4-C5-C6-O6
5	C	1304	NAG	O5-C5-C6-O6
5	A	1301	NAG	C4-C5-C6-O6
5	B	1309	NAG	C4-C5-C6-O6
5	C	1305	NAG	C8-C7-N2-C2
5	C	1305	NAG	O7-C7-N2-C2
5	C	1308	NAG	C8-C7-N2-C2
5	C	1308	NAG	O7-C7-N2-C2
5	B	1302	NAG	C8-C7-N2-C2
5	B	1302	NAG	O7-C7-N2-C2
5	B	1303	NAG	C8-C7-N2-C2
5	B	1303	NAG	O7-C7-N2-C2
5	B	1305	NAG	C8-C7-N2-C2
5	B	1305	NAG	O7-C7-N2-C2
5	A	1303	NAG	C8-C7-N2-C2
5	A	1303	NAG	O7-C7-N2-C2
5	A	1305	NAG	C8-C7-N2-C2
5	A	1305	NAG	O7-C7-N2-C2
5	B	1306	NAG	O5-C5-C6-O6
5	B	1305	NAG	C4-C5-C6-O6
5	C	1303	NAG	O5-C5-C6-O6
5	C	1304	NAG	C4-C5-C6-O6
5	B	1304	NAG	C4-C5-C6-O6
5	C	1303	NAG	C4-C5-C6-O6
5	B	1305	NAG	O5-C5-C6-O6
5	A	1303	NAG	O5-C5-C6-O6

Continued on next page...

Continued from previous page...

Mol	Chain	Res	Type	Atoms
5	B	1301	NAG	C4-C5-C6-O6
5	C	1306	NAG	O5-C5-C6-O6
5	B	1301	NAG	O5-C5-C6-O6
5	B	1307	NAG	O5-C5-C6-O6
5	A	1306	NAG	O5-C5-C6-O6
5	A	1305	NAG	O5-C5-C6-O6
5	B	1306	NAG	C4-C5-C6-O6
5	C	1308	NAG	C4-C5-C6-O6
5	C	1308	NAG	O5-C5-C6-O6
5	C	1301	NAG	C1-C2-N2-C7
5	B	1301	NAG	C1-C2-N2-C7
5	C	1301	NAG	C3-C2-N2-C7
5	B	1301	NAG	C3-C2-N2-C7
5	A	1301	NAG	C3-C2-N2-C7
5	B	1304	NAG	C1-C2-N2-C7
5	A	1301	NAG	C1-C2-N2-C7
5	A	1304	NAG	C1-C2-N2-C7
5	A	1304	NAG	C1-C2-N2-C7
5	A	1303	NAG	C4-C5-C6-O6

There are no ring outliers.

4 monomers are involved in 4 short contacts:

Mol	Chain	Res	Type	Clashes	Symm-Clashes
5	A	1308	NAG	1	0
5	A	1306	NAG	1	0
5	C	1302	NAG	1	0
5	A	1307	NAG	1	0

The following is a two-dimensional graphical depiction of Mogul quality analysis of bond lengths, bond angles, torsion angles, and ring geometry for all instances of the Ligand of Interest. In addition, ligands with molecular weight > 250 and outliers as shown on the validation Tables will also be included. For torsion angles, if less than 5% of the Mogul distribution of torsion angles is within 10 degrees of the torsion angle in question, then that torsion angle is considered an outlier. Any bond that is central to one or more torsion angles identified as an outlier by Mogul will be highlighted in the graph. For rings, the root-mean-square deviation (RMSD) between the ring in question and similar rings identified by Mogul is calculated over all ring torsion angles. If the average RMSD is greater than 60 degrees and the minimal RMSD between the ring in question and any Mogul-identified rings is also greater than 60 degrees, then that ring is considered an outlier. The outliers are highlighted in purple. The color gray indicates Mogul did not find sufficient equivalents in the CSD to analyse the geometry.

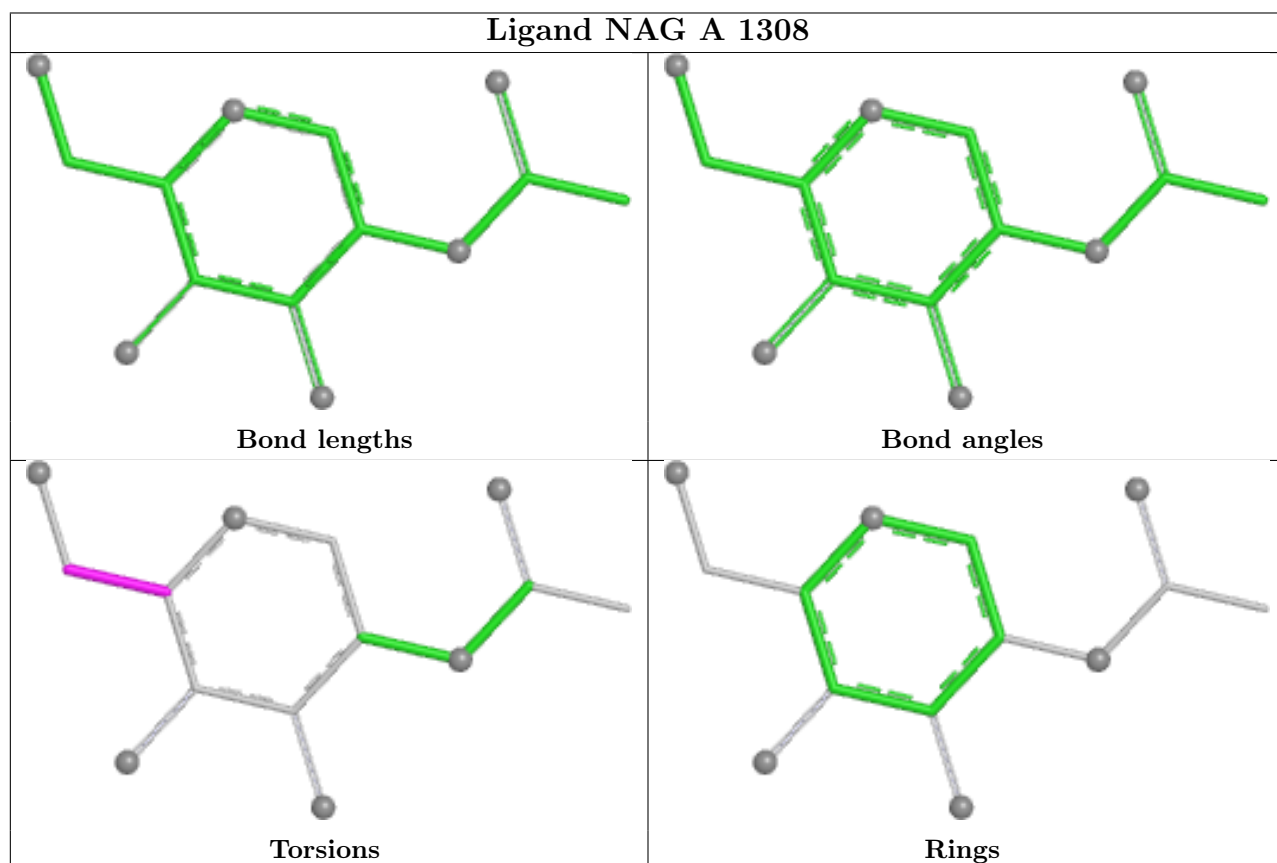
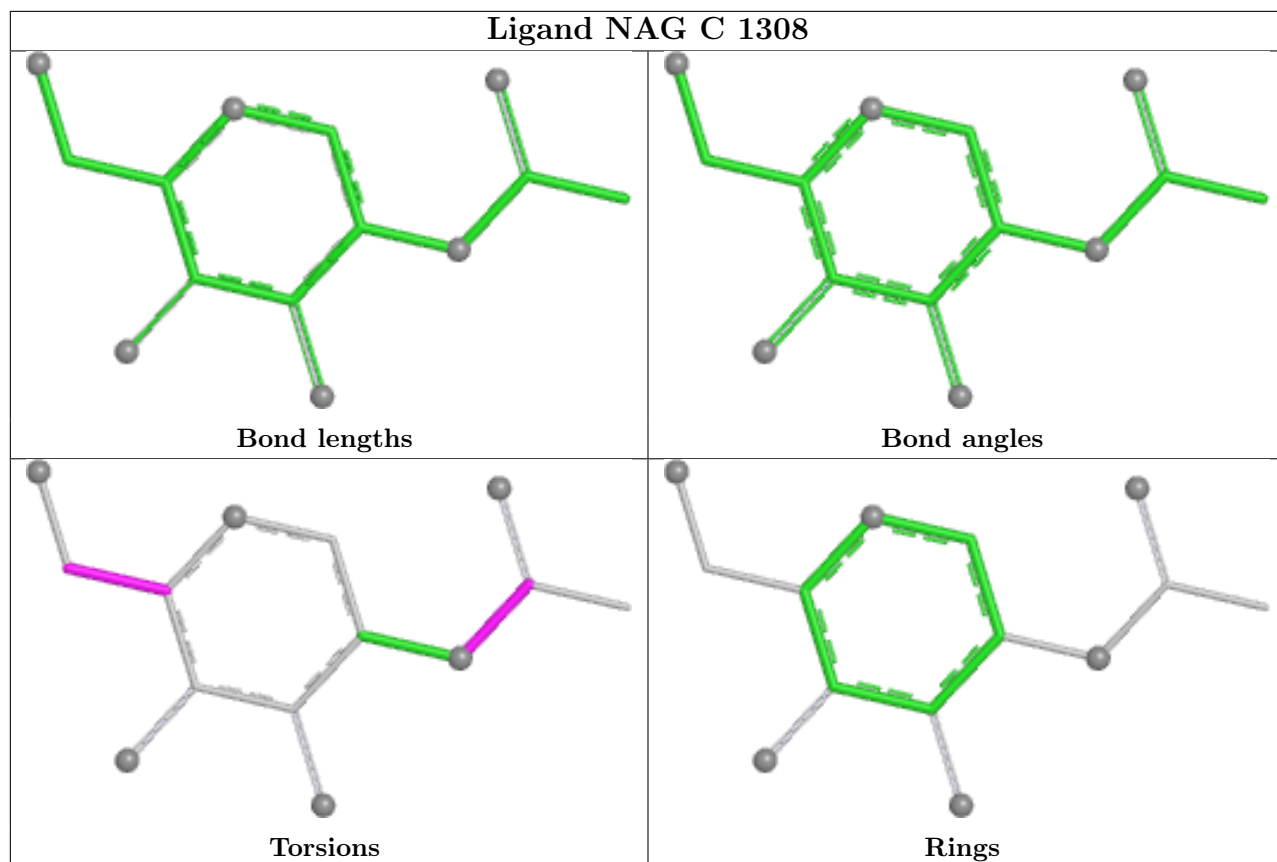

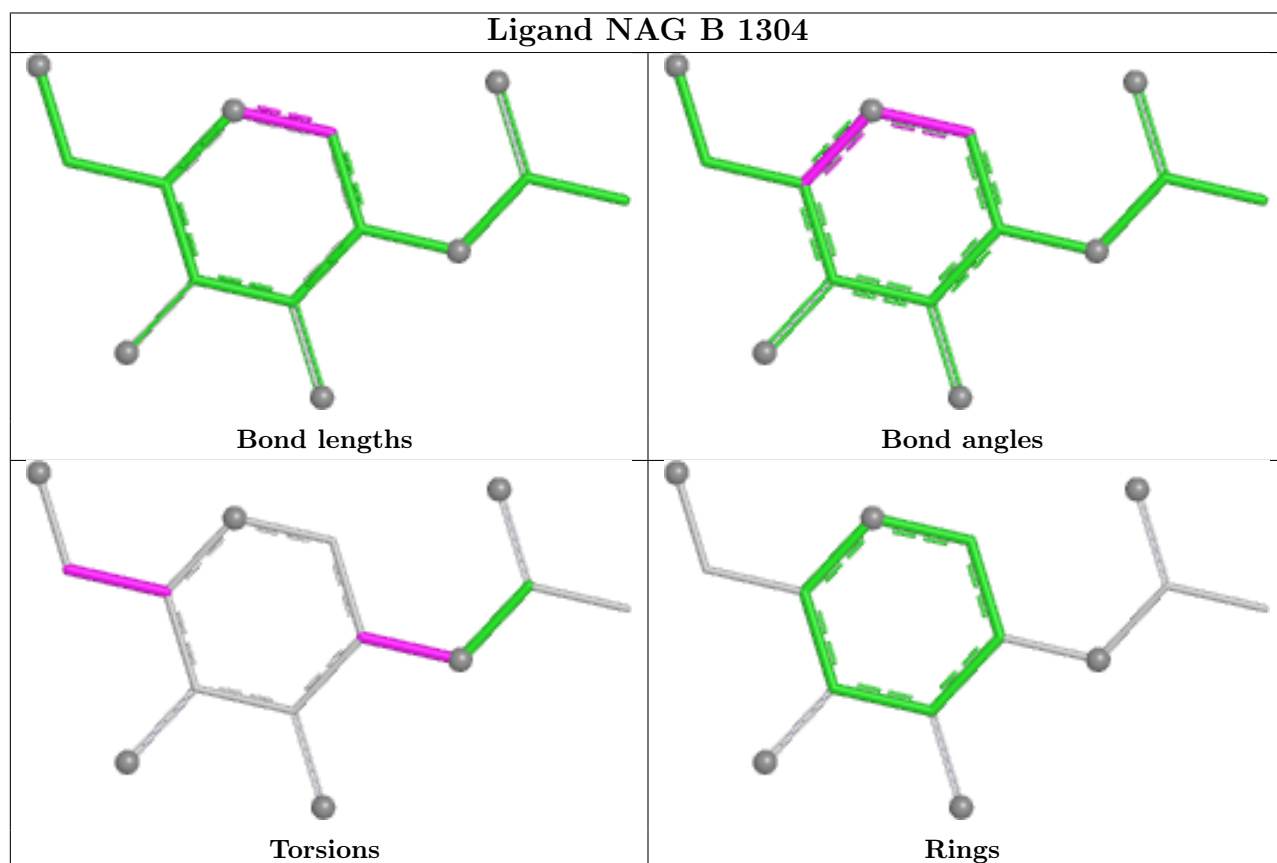
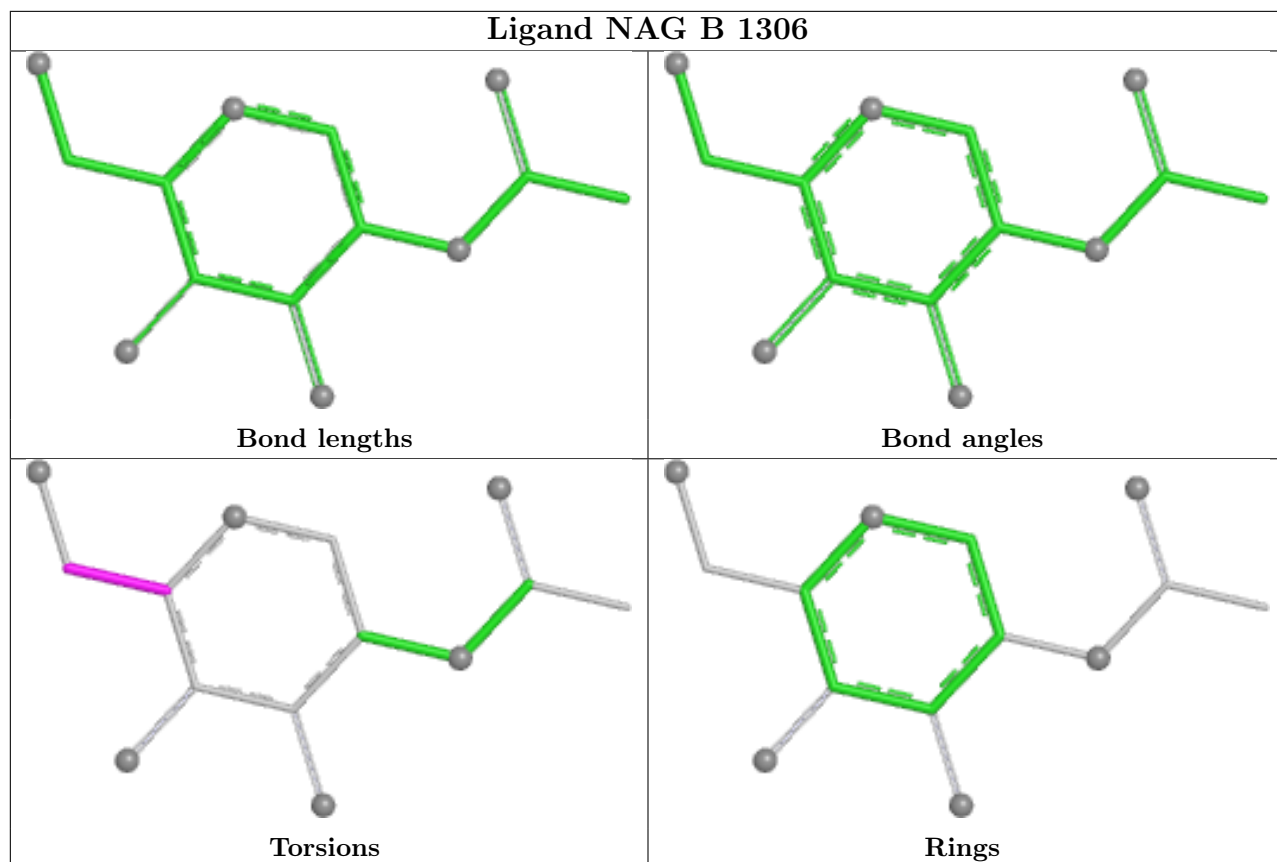

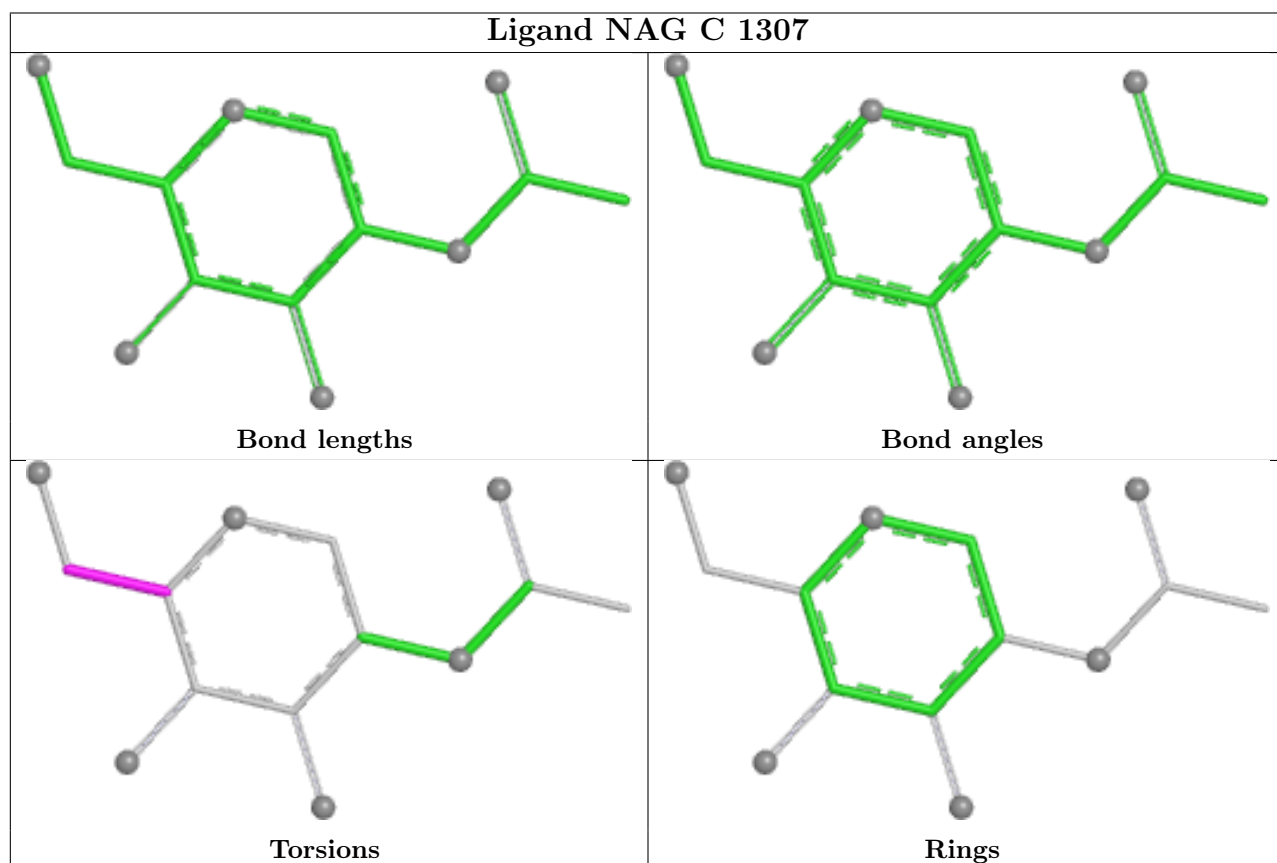
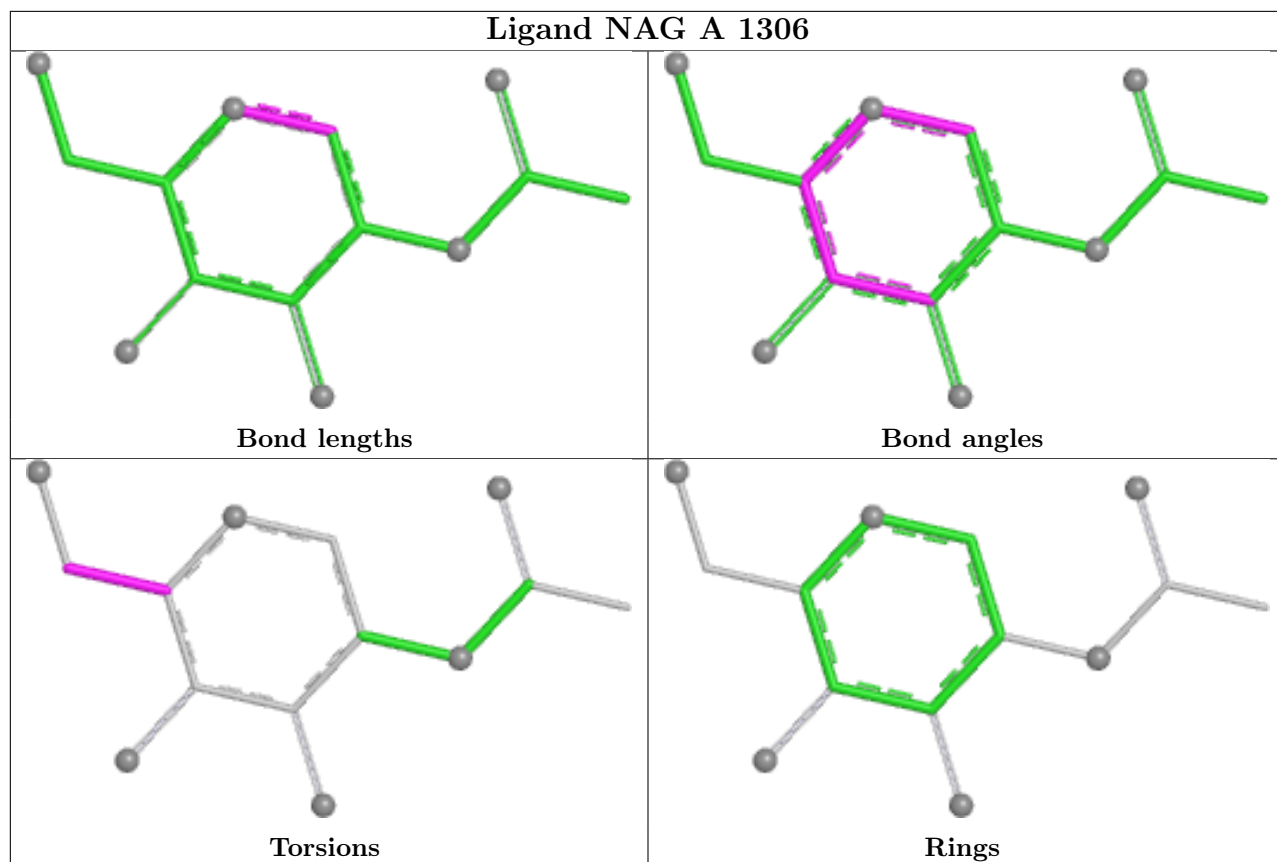

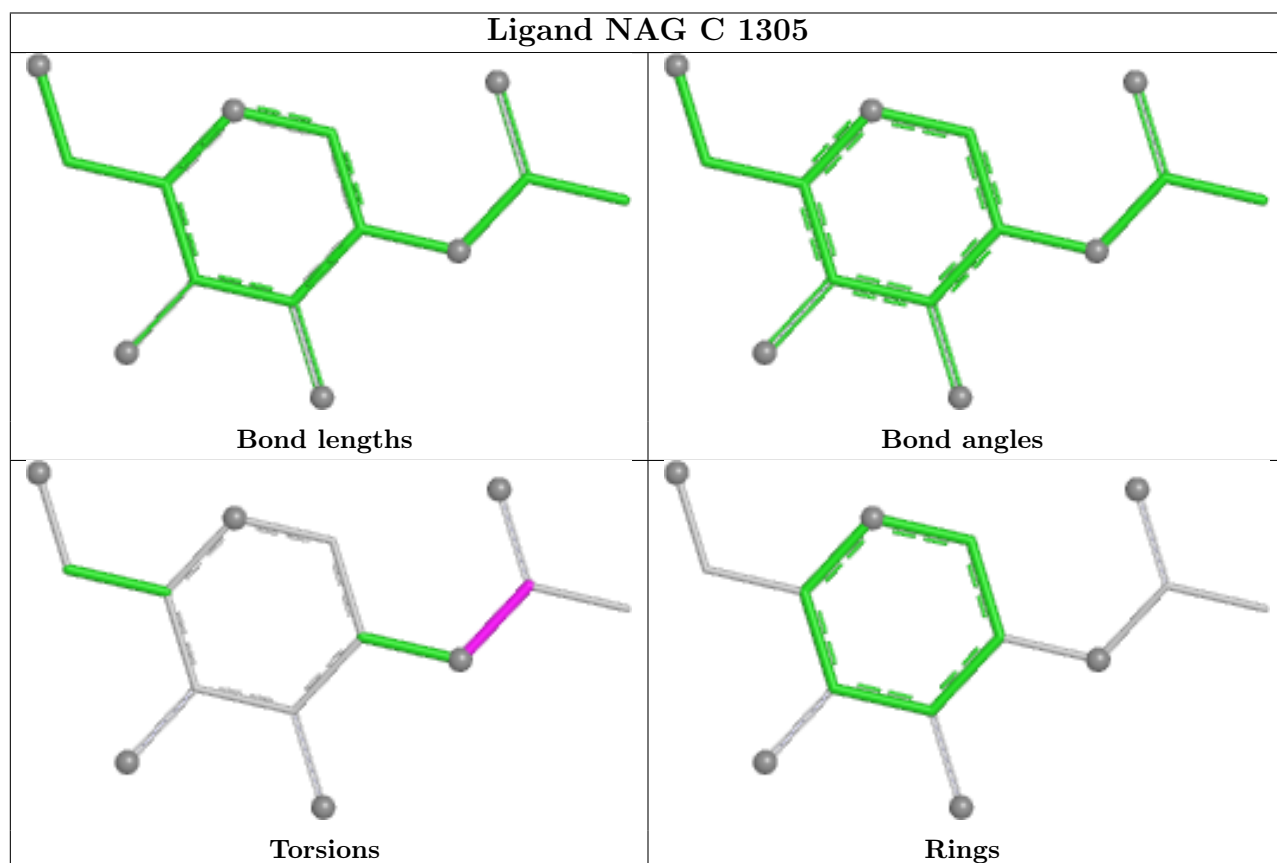
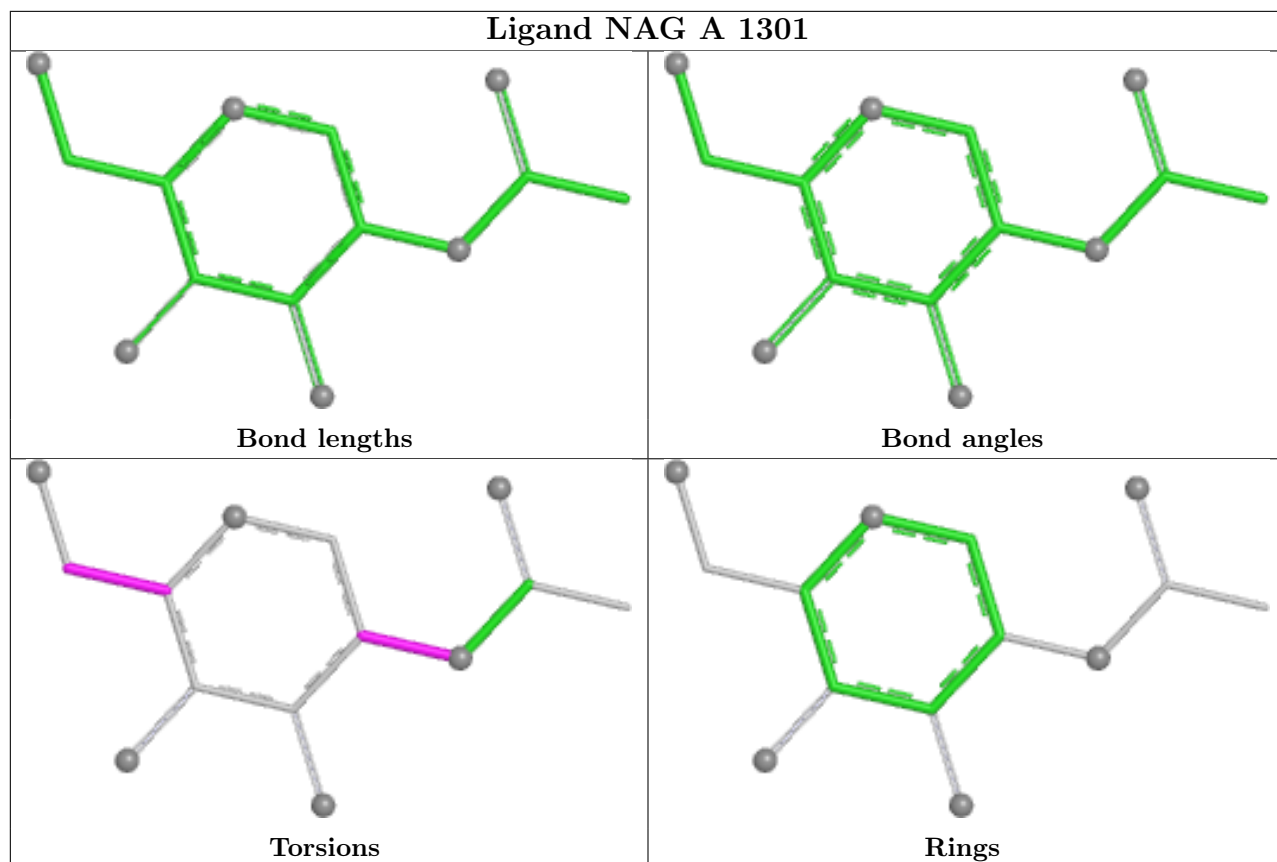

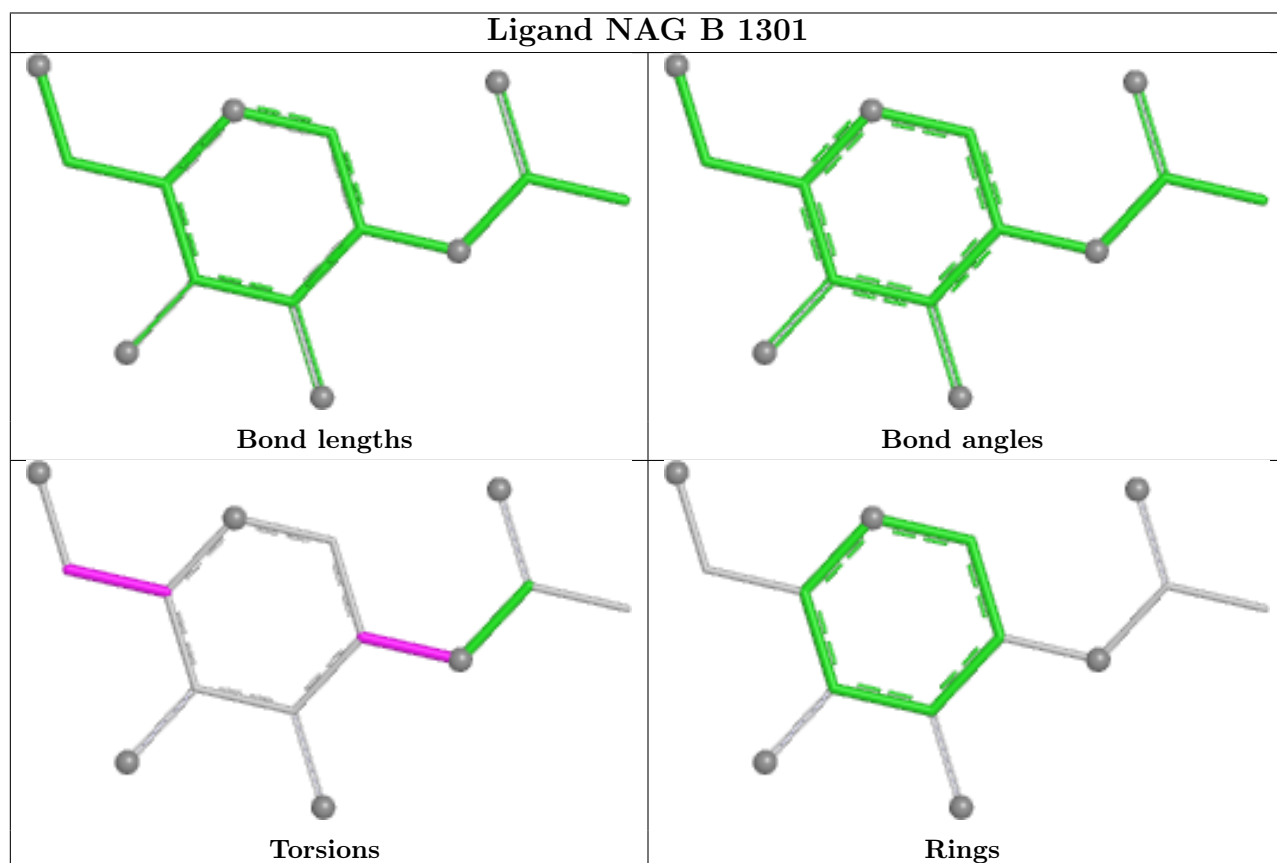
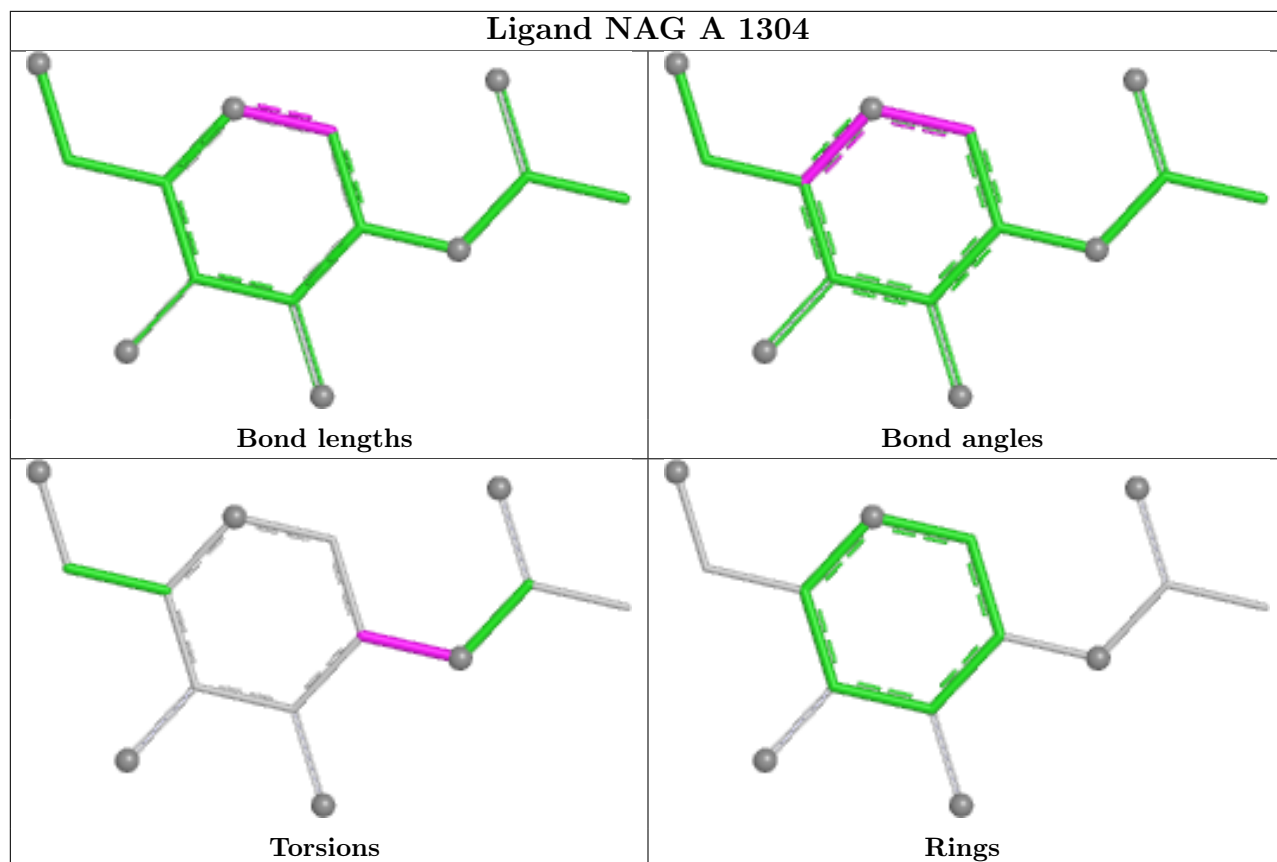

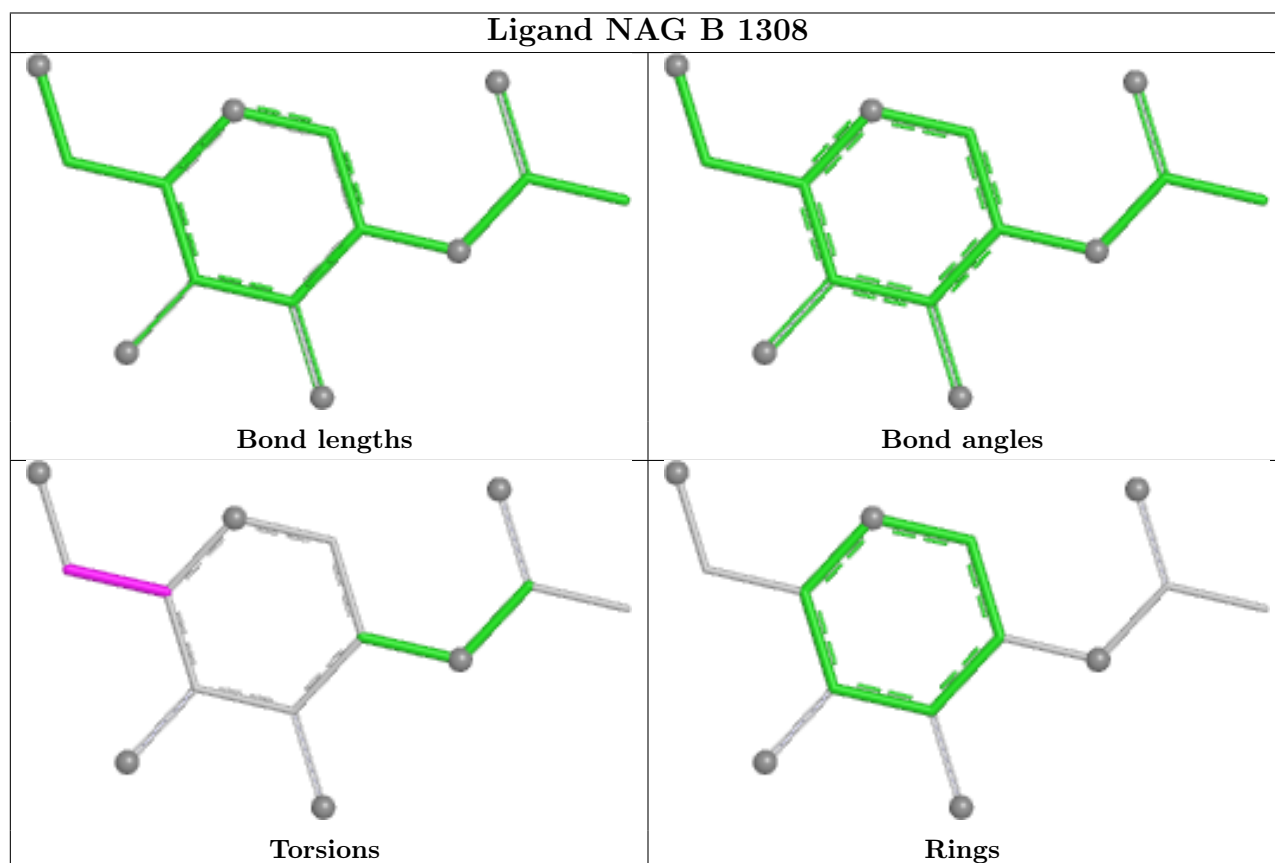
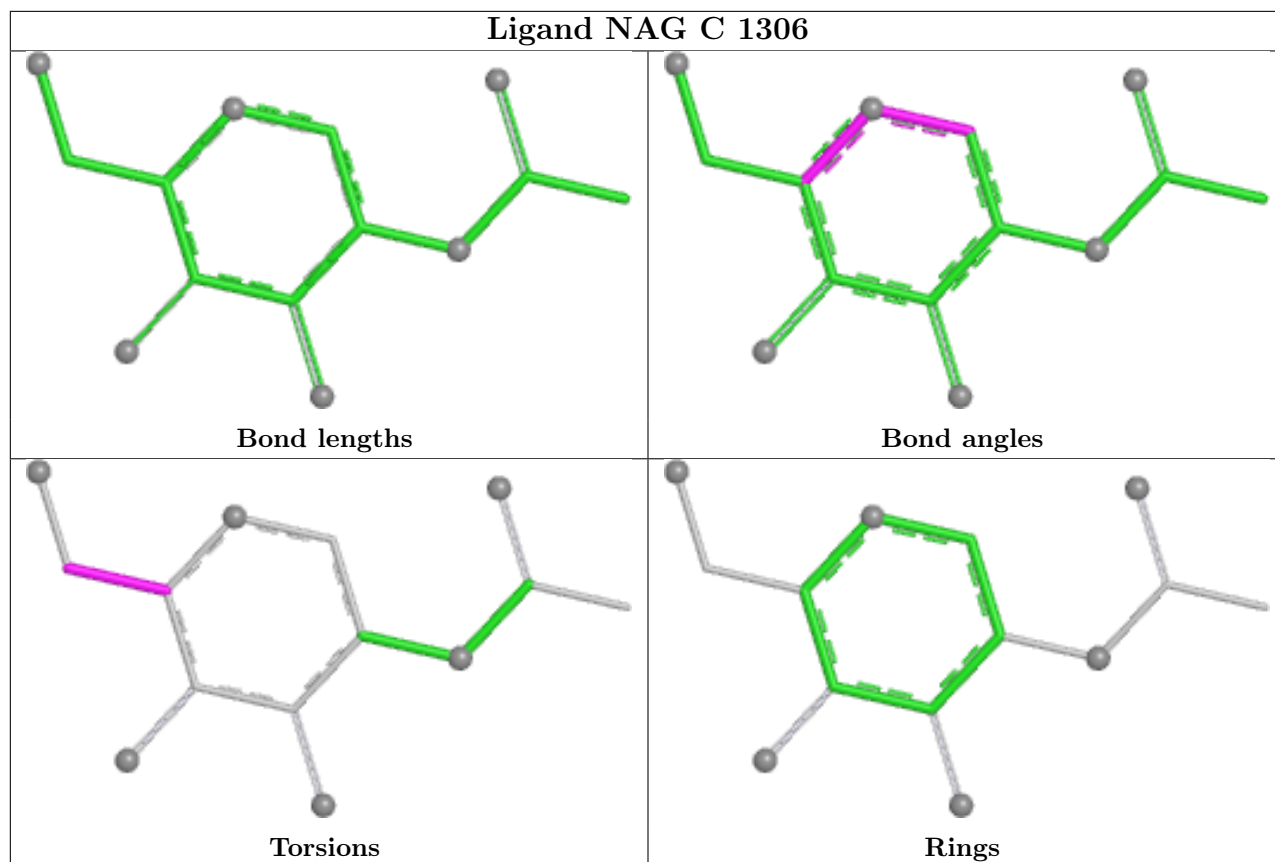

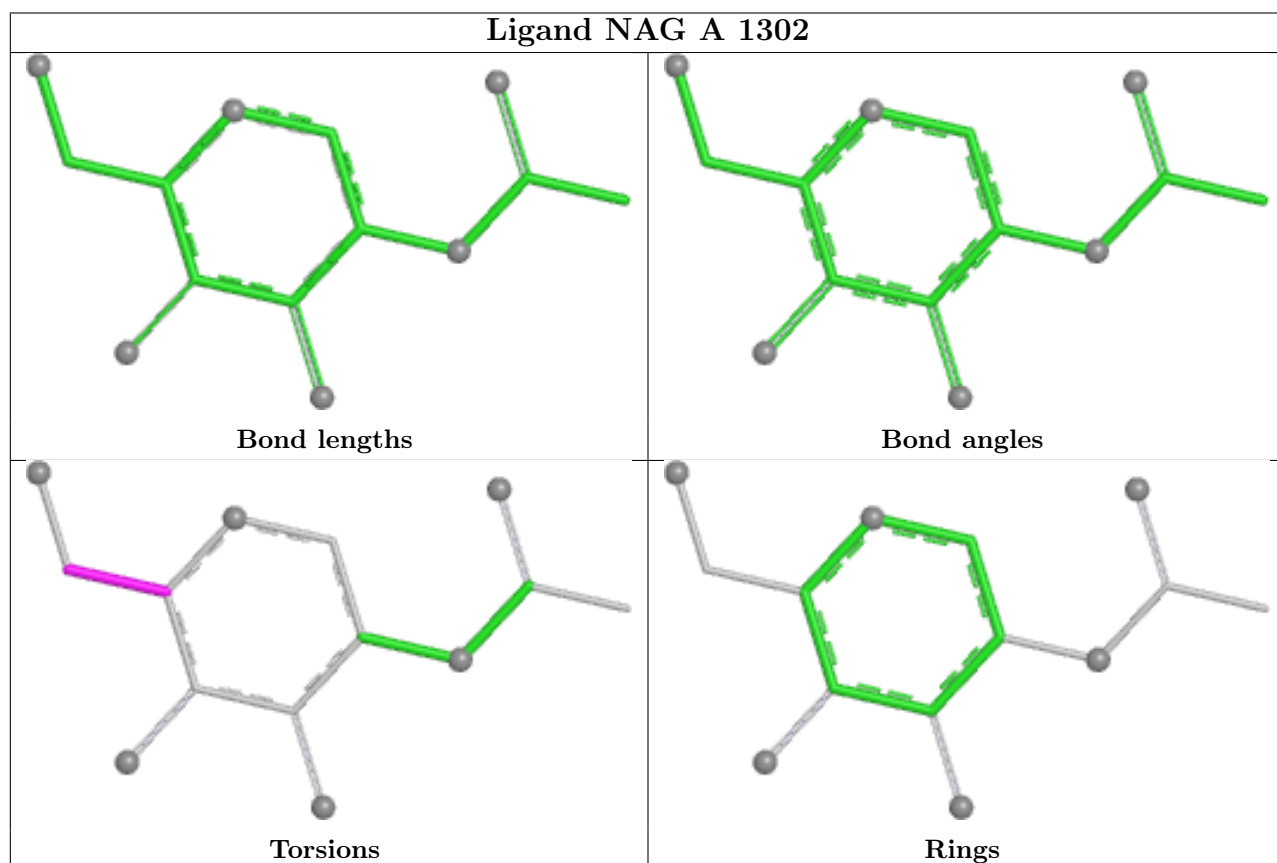
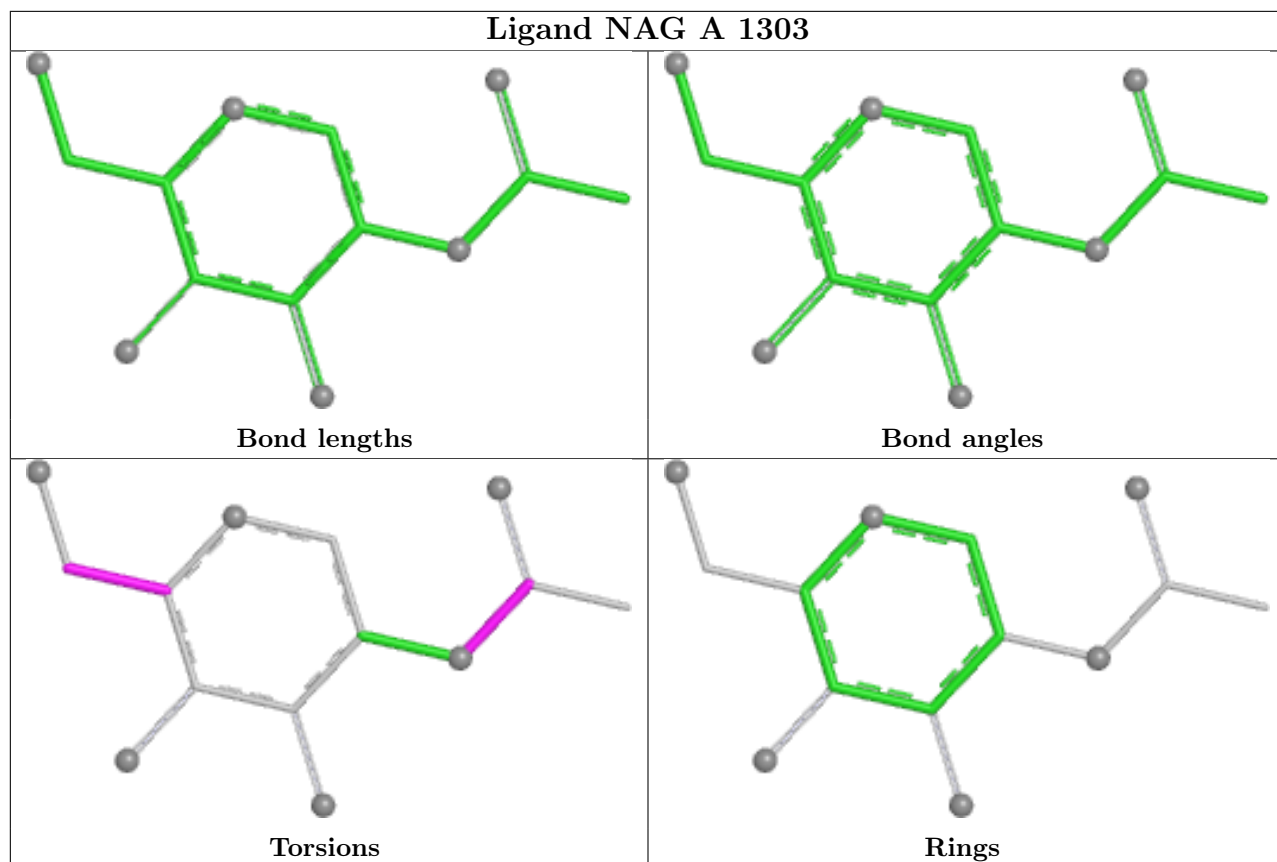

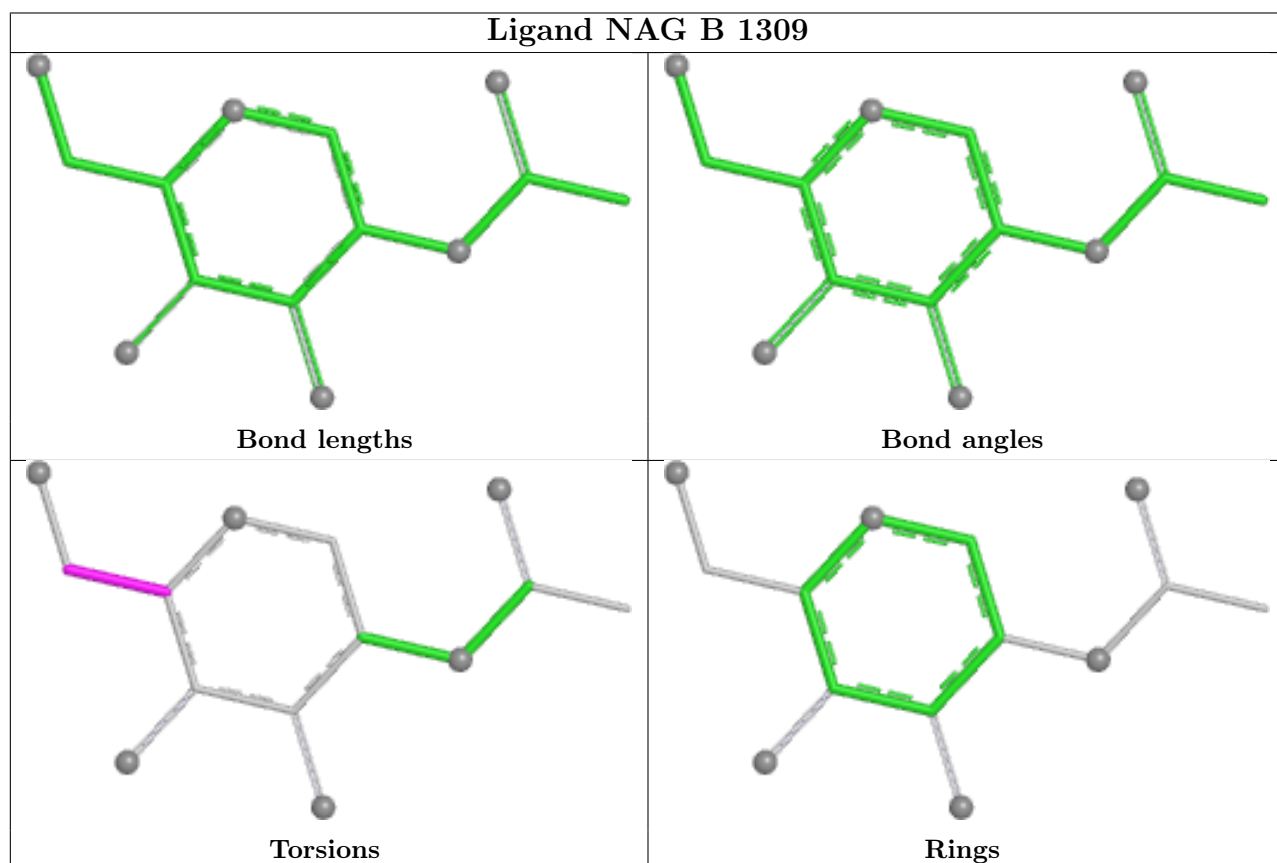
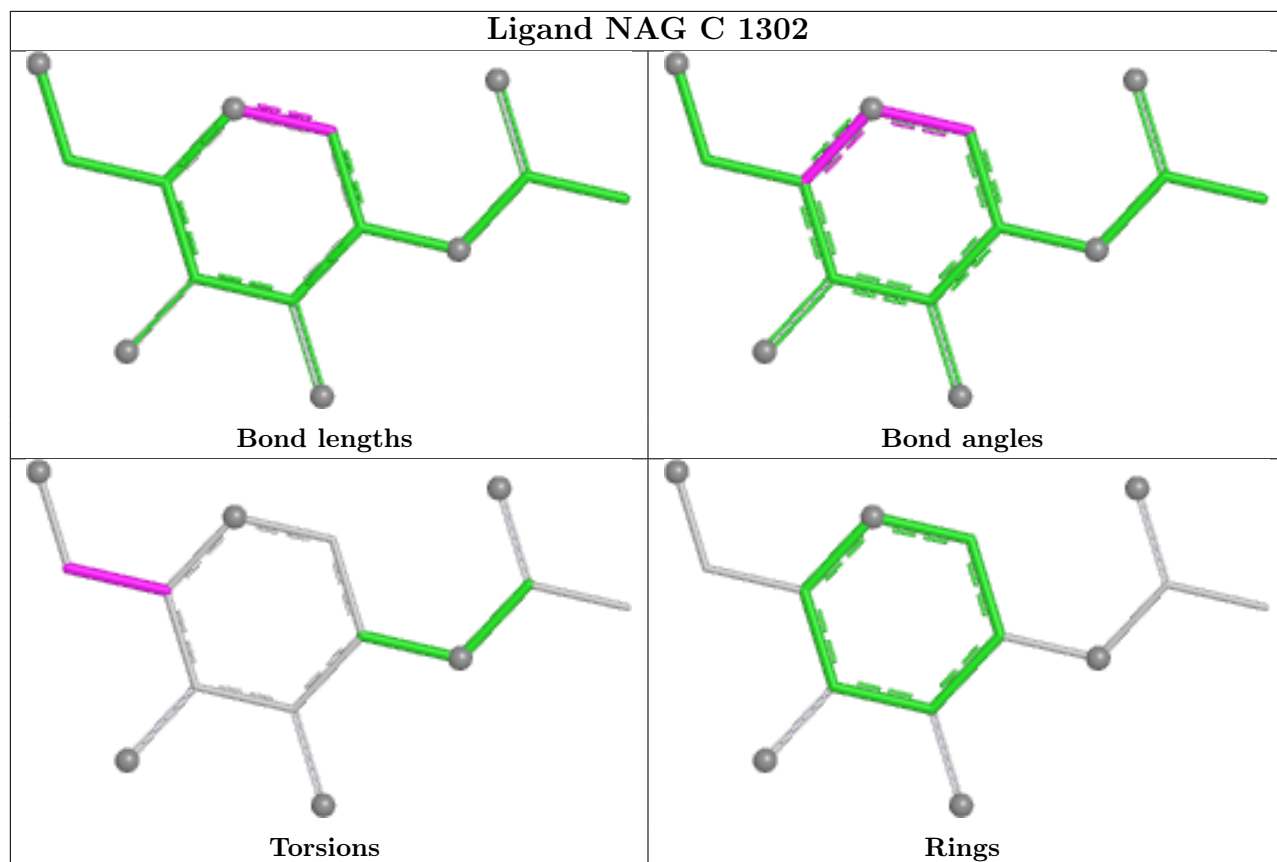

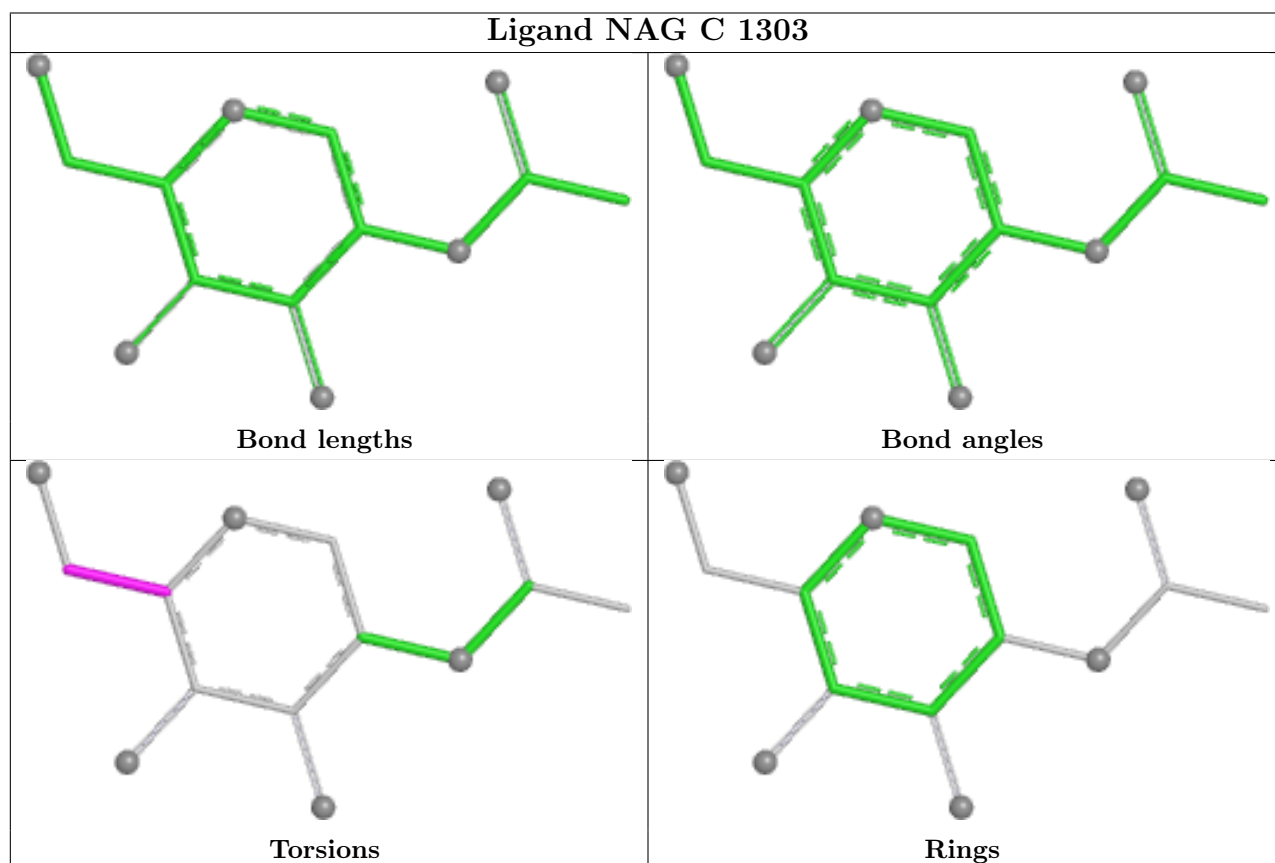
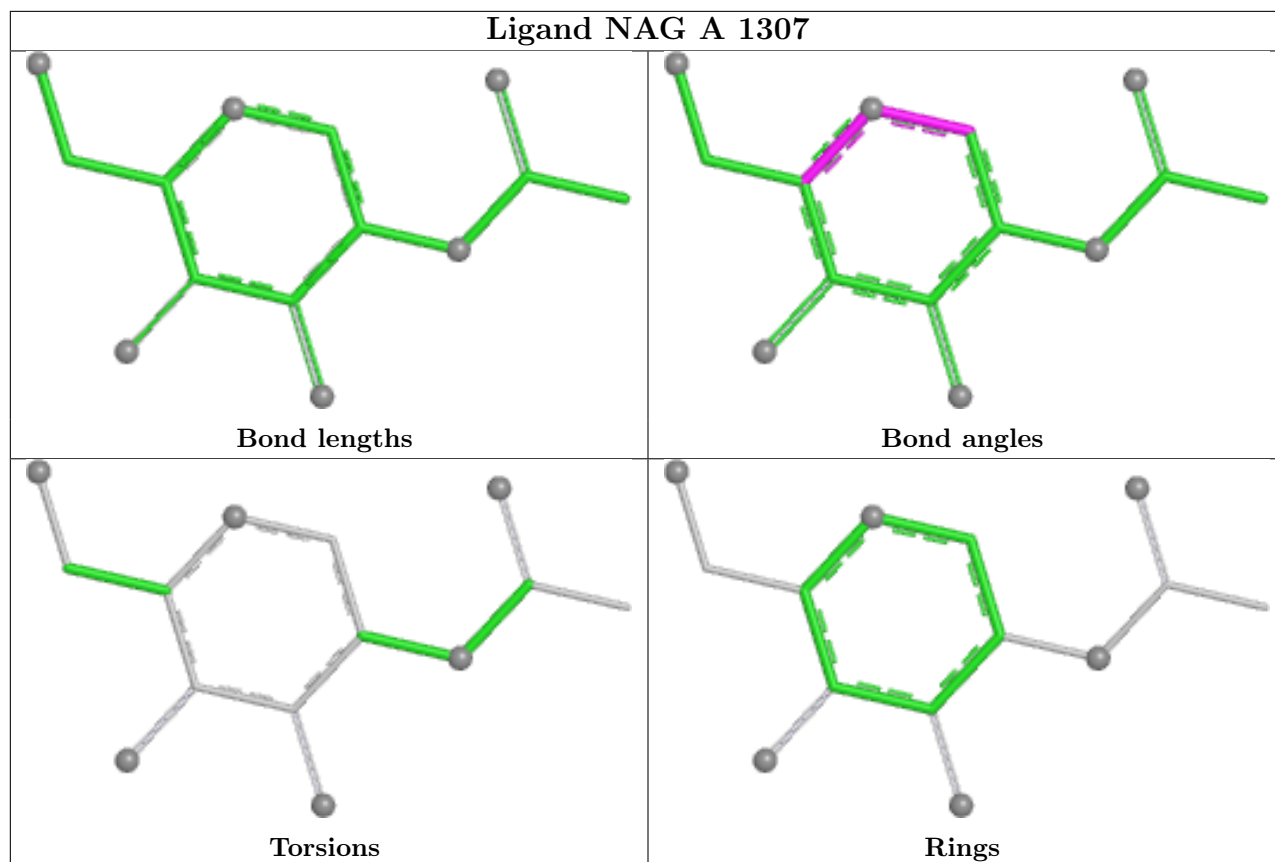

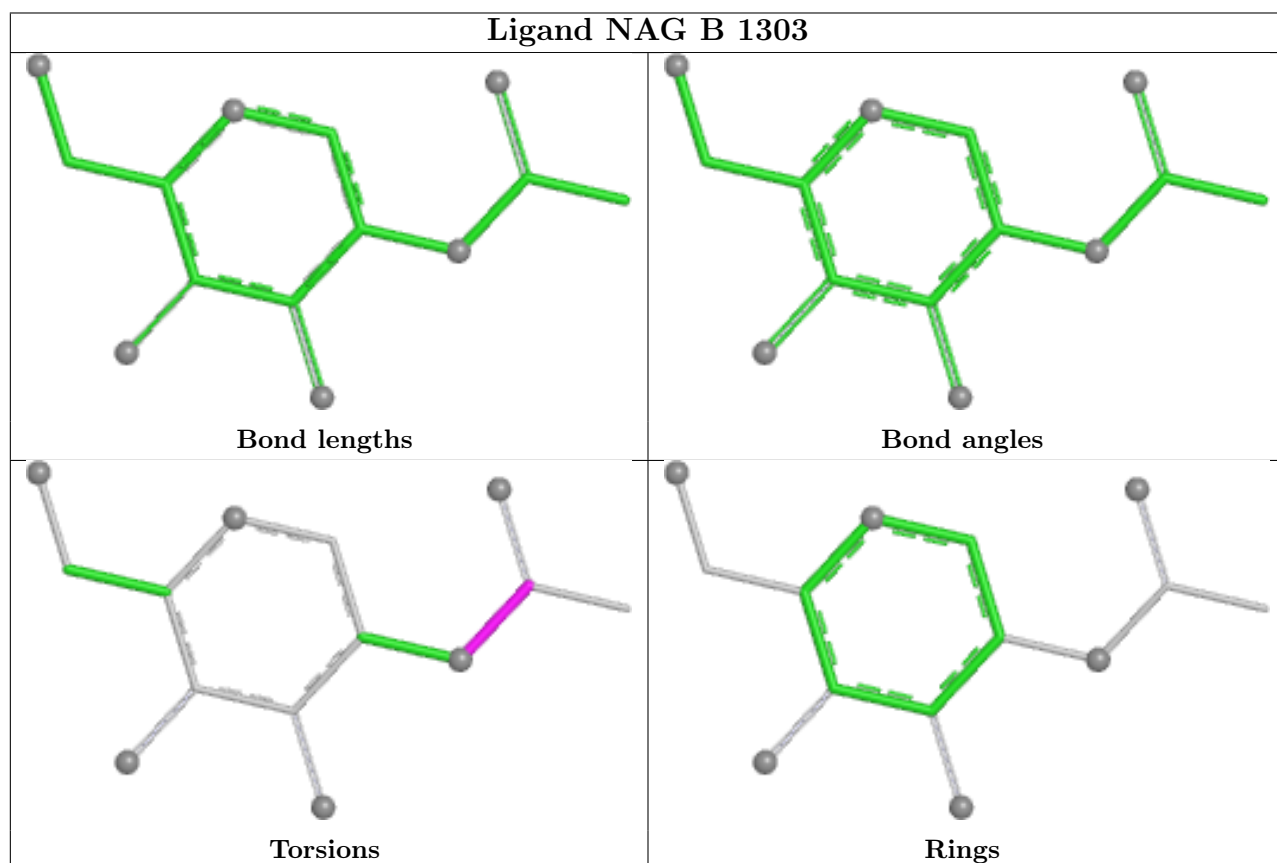
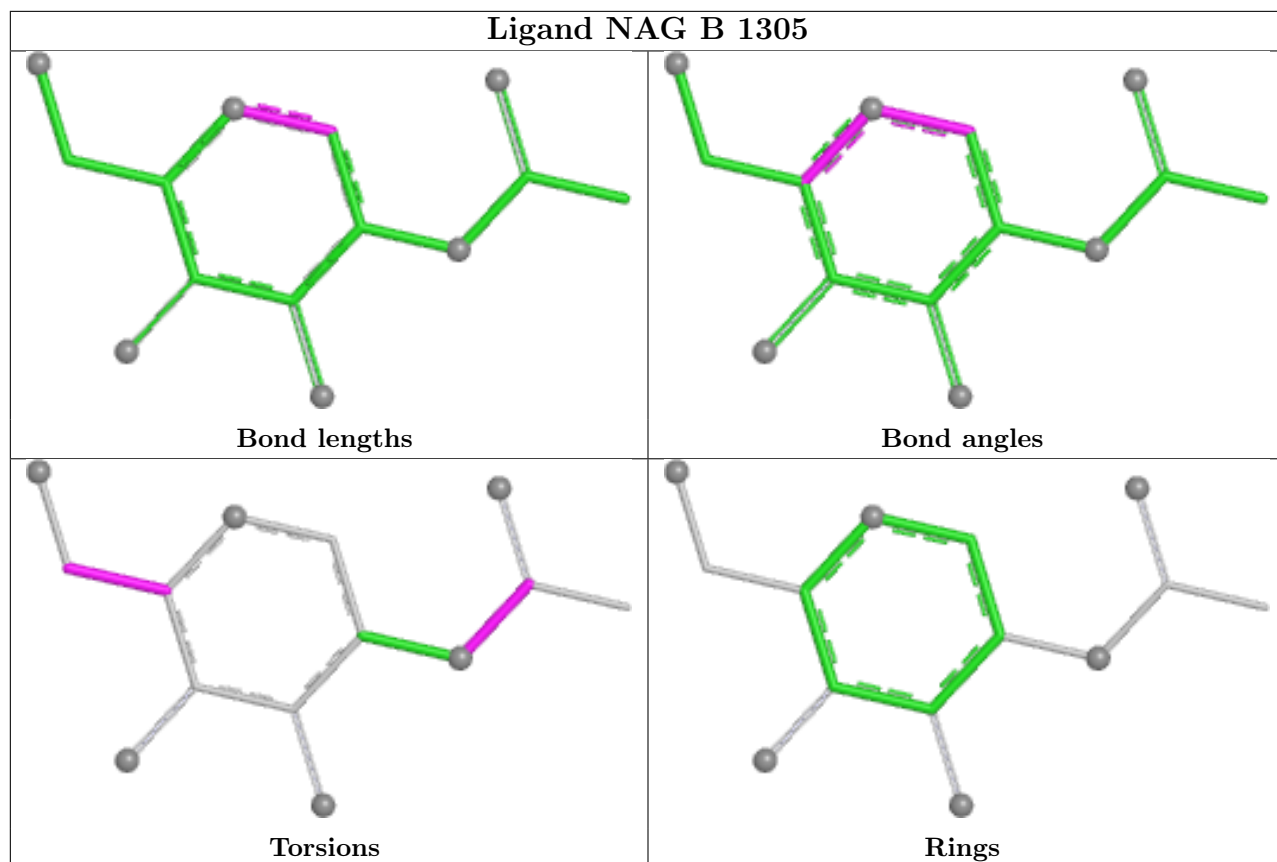

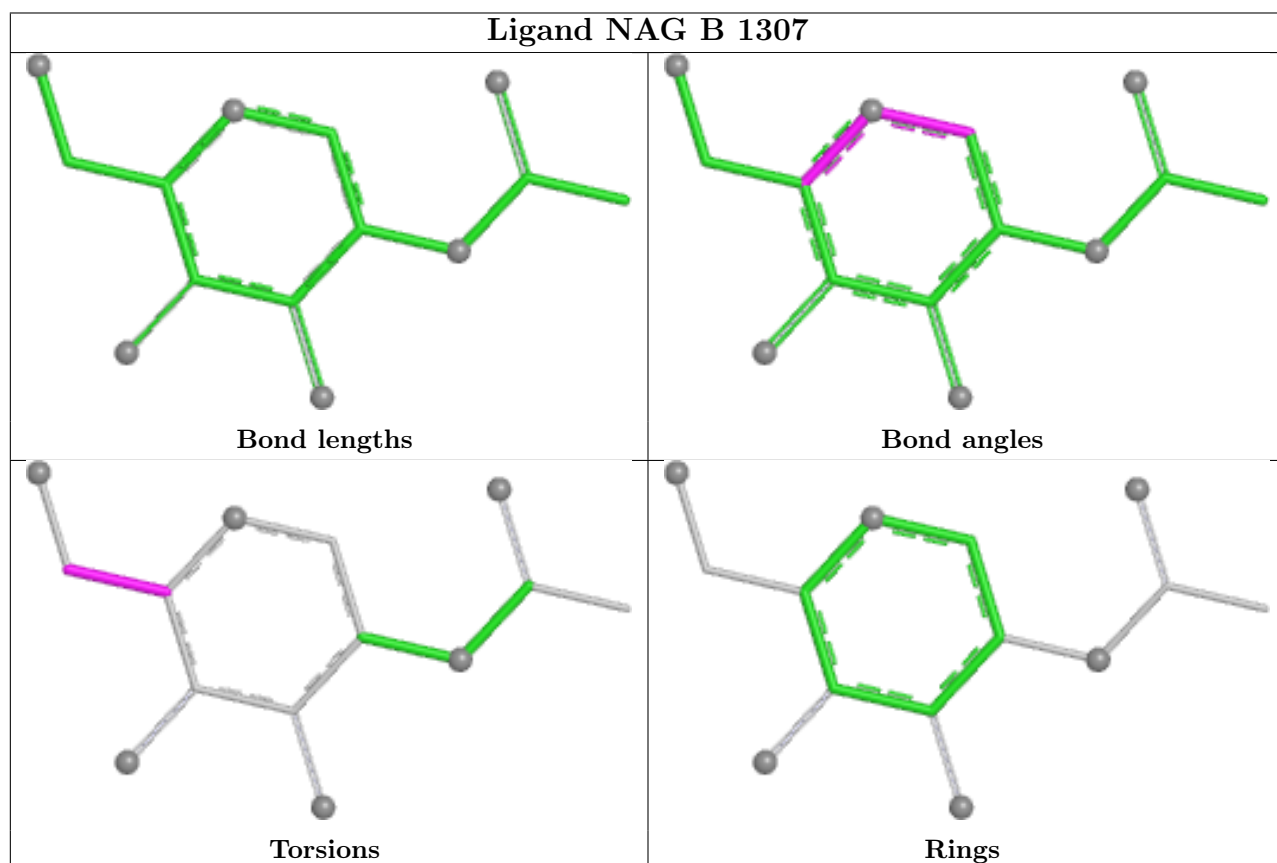
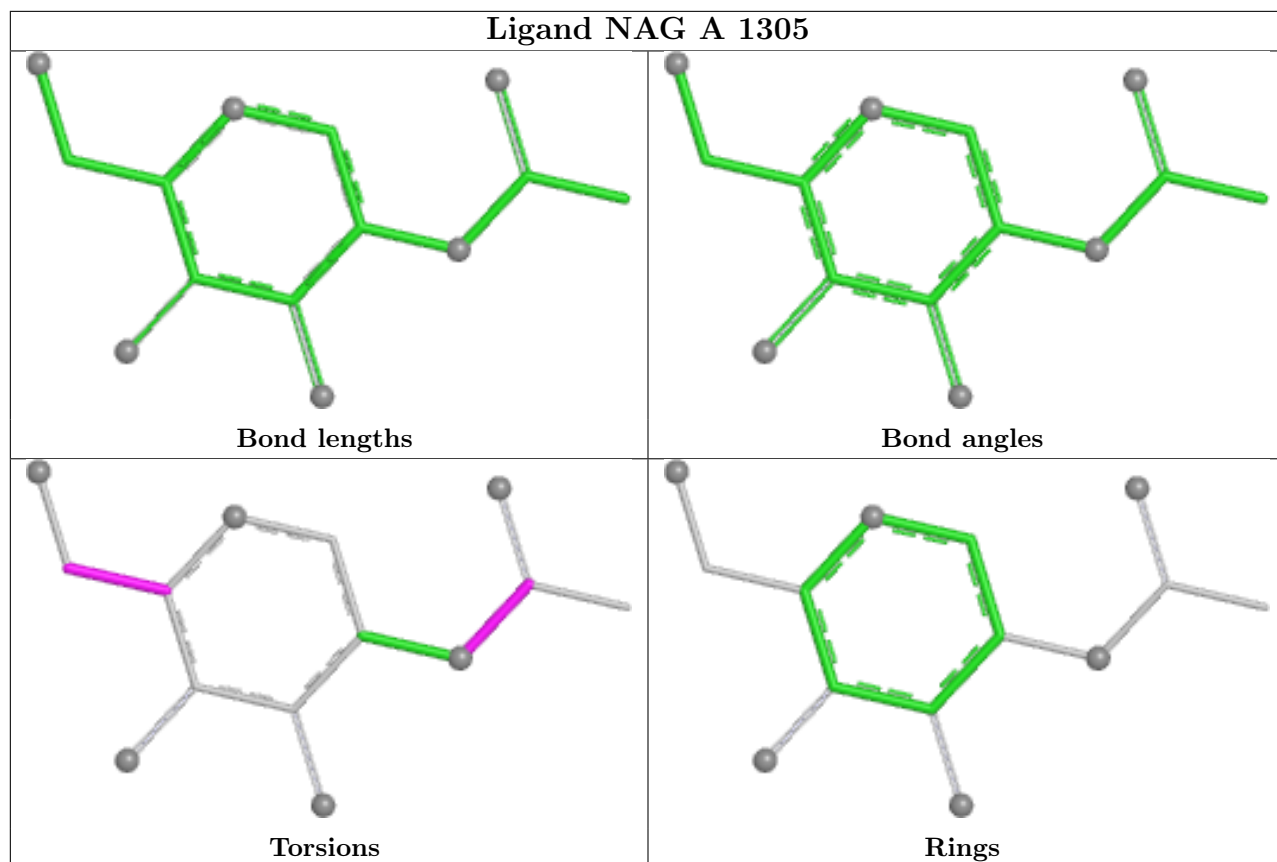

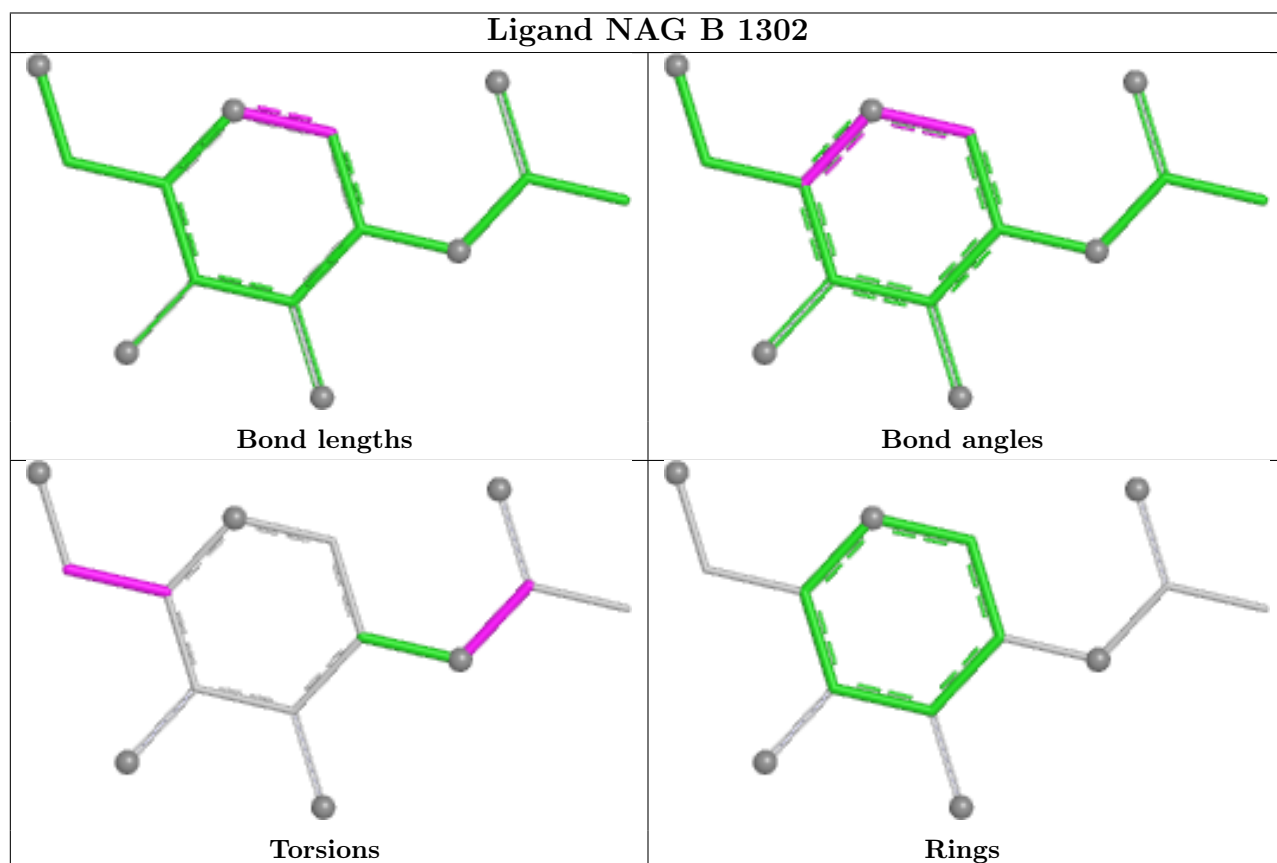
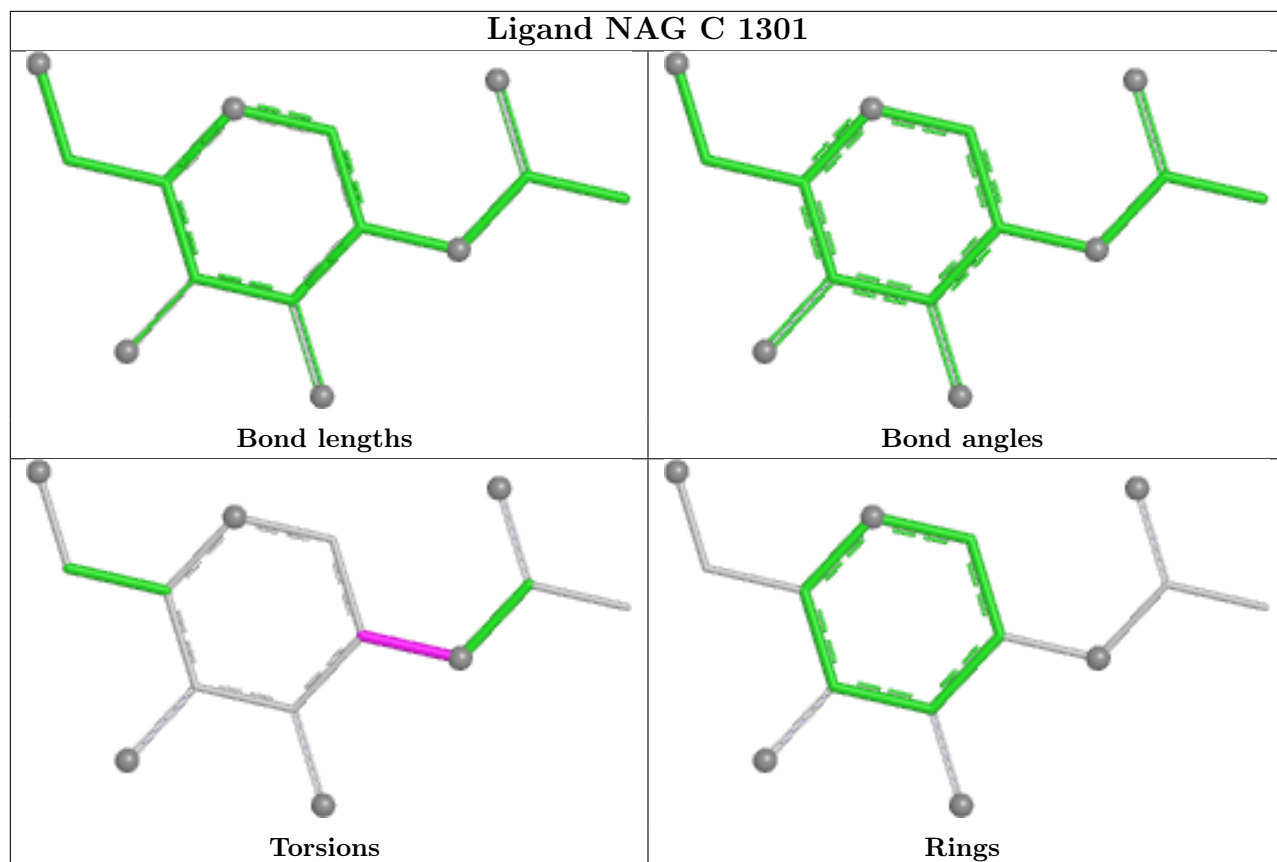

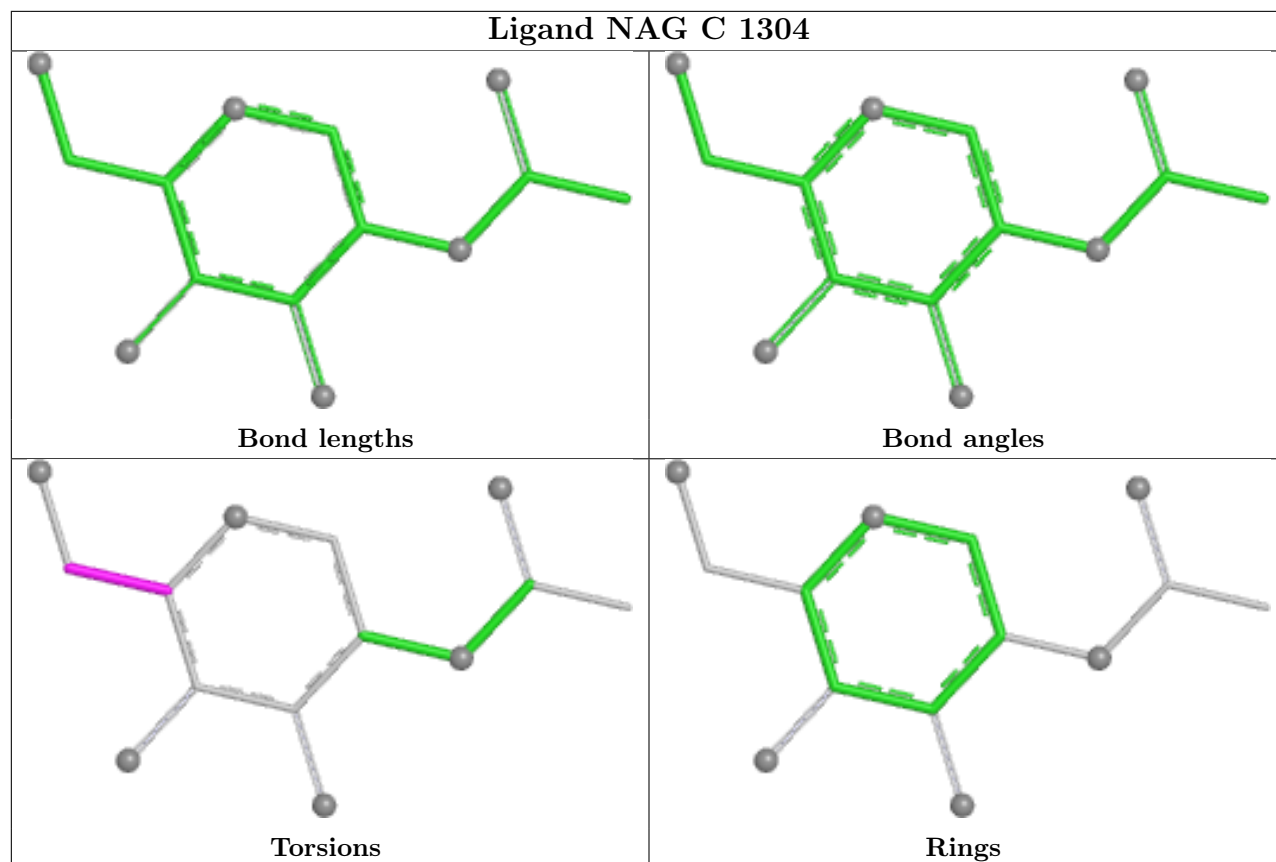

5.7 Other polymers [i](#)

There are no such residues in this entry.

5.8 Polymer linkage issues [i](#)

There are no chain breaks in this entry.

6 Map visualisation [i](#)

This section contains visualisations of the EMDB entry EMD-24063. These allow visual inspection of the internal detail of the map and identification of artifacts.

No raw map or half-maps were deposited for this entry and therefore no images, graphs, etc. pertaining to the raw map can be shown.

6.1 Orthogonal projections [i](#)

6.1.1 Primary map

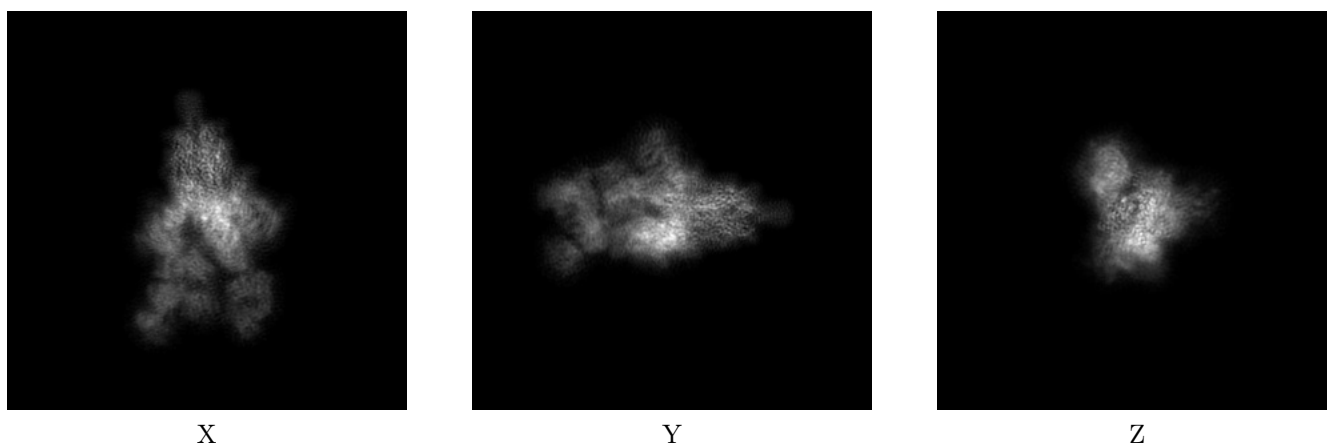

The images above show the map projected in three orthogonal directions.

6.2 Central slices [i](#)

6.2.1 Primary map

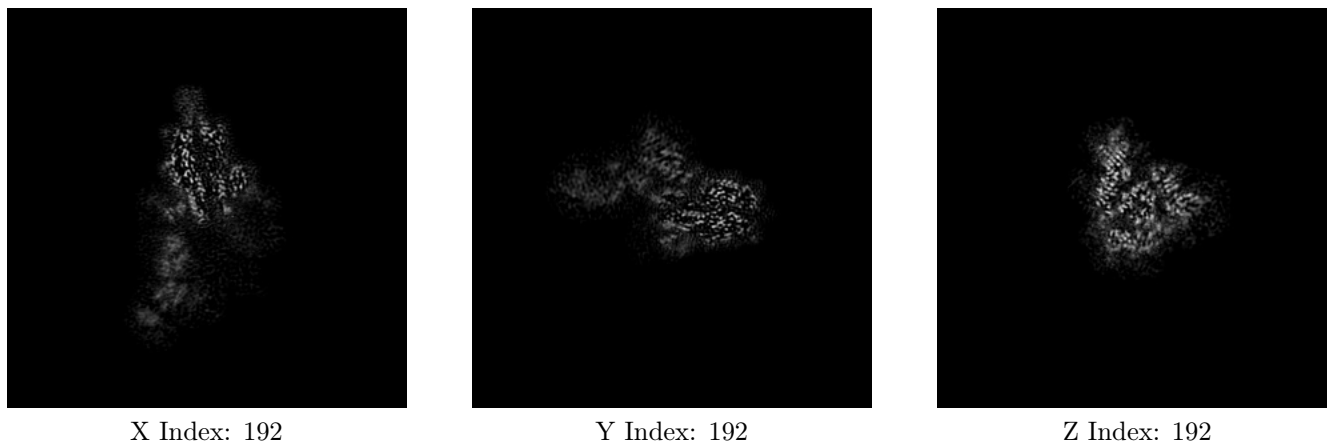

The images above show central slices of the map in three orthogonal directions.

6.3 Largest variance slices [i](#)

6.3.1 Primary map

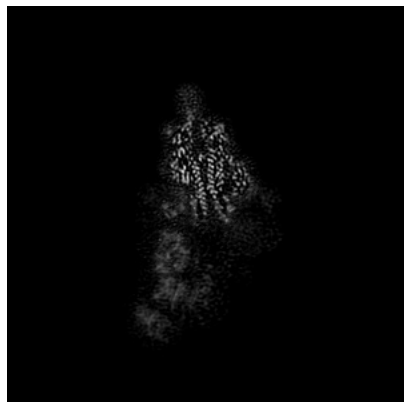

X Index: 195

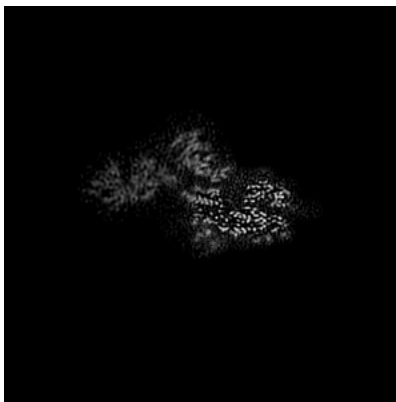

Y Index: 189

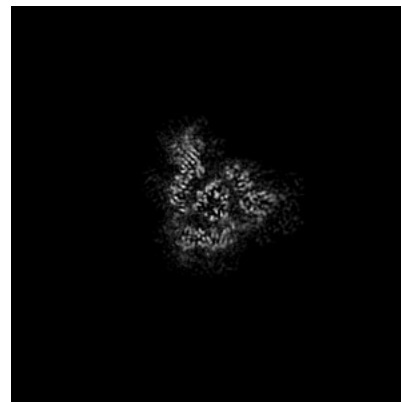

Z Index: 191

The images above show the largest variance slices of the map in three orthogonal directions.

6.4 Orthogonal standard-deviation projections (False-color) [i](#)

6.4.1 Primary map

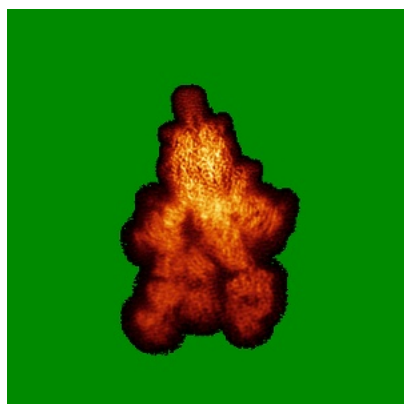

X

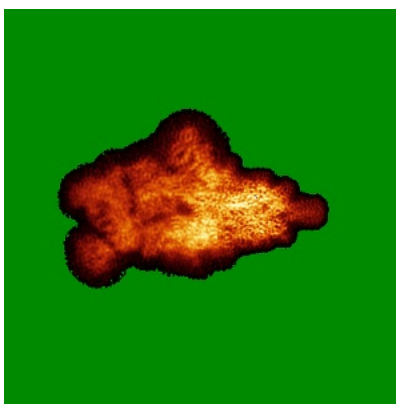

Y

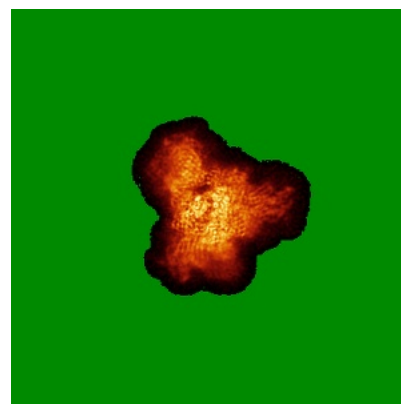

Z

The images above show the map standard deviation projections with false color in three orthogonal directions. Minimum values are shown in green, max in blue, and dark to light orange shades represent small to large values respectively.

6.5 Orthogonal surface views [i](#)

6.5.1 Primary map

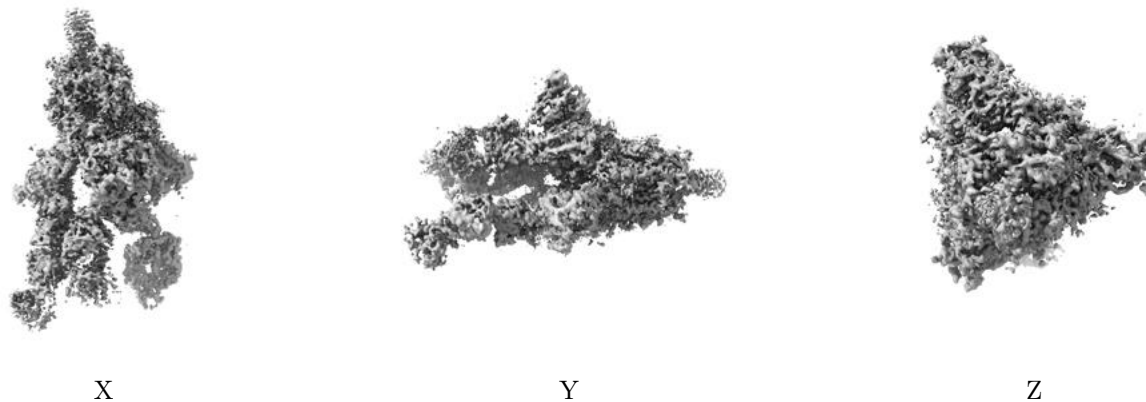

The images above show the 3D surface view of the map at the recommended contour level 0.022. These images, in conjunction with the slice images, may facilitate assessment of whether an appropriate contour level has been provided.

6.6 Mask visualisation [i](#)

This section was not generated. No masks/segmentation were deposited.

7 Map analysis [i](#)

This section contains the results of statistical analysis of the map.

7.1 Map-value distribution [i](#)

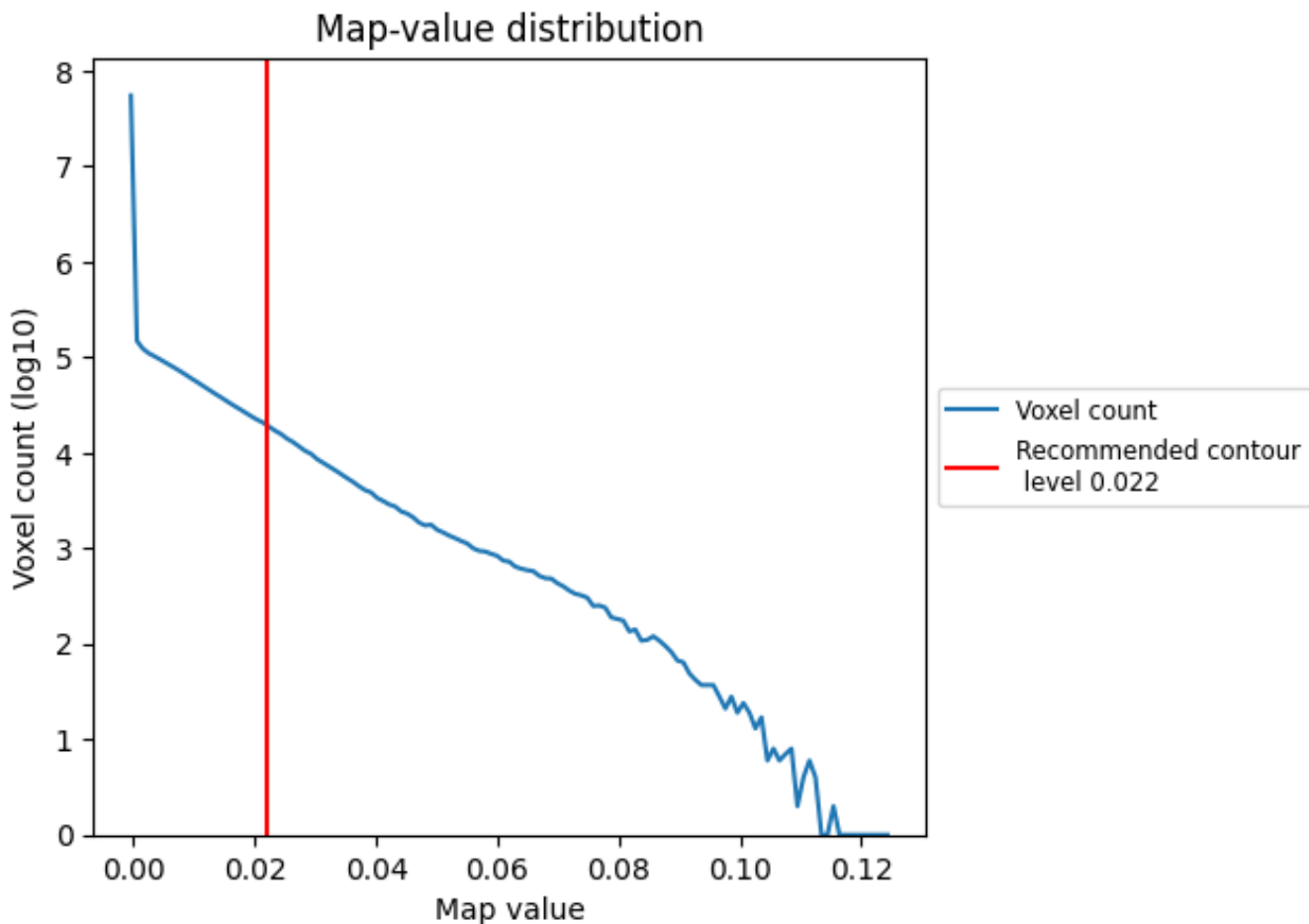

The map-value distribution is plotted in 128 intervals along the x-axis. The y-axis is logarithmic. A spike in this graph at zero usually indicates that the volume has been masked.

7.2 Volume estimate [i](#)

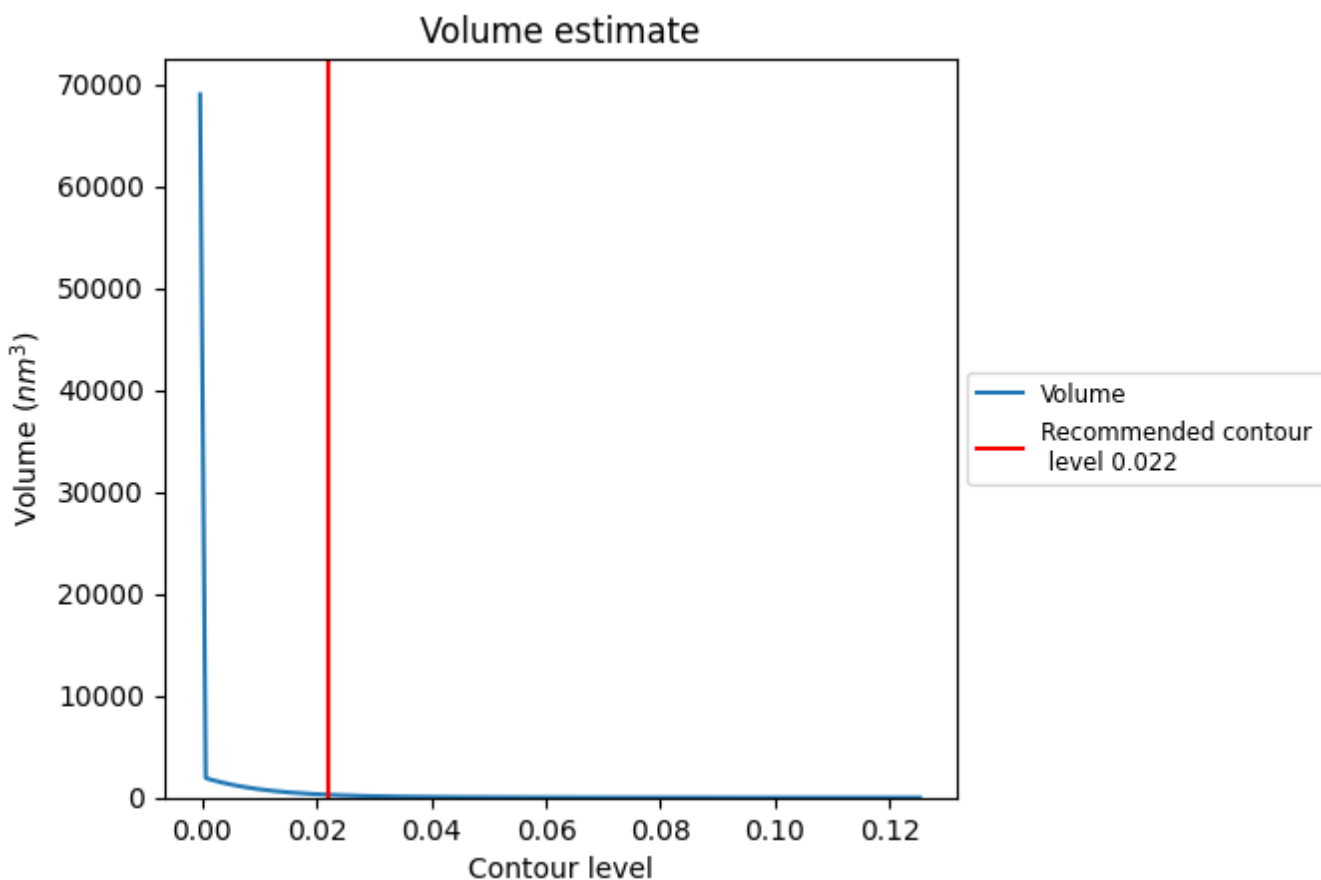

The volume at the recommended contour level is 274 nm³; this corresponds to an approximate mass of 248 kDa.

The volume estimate graph shows how the enclosed volume varies with the contour level. The recommended contour level is shown as a vertical line and the intersection between the line and the curve gives the volume of the enclosed surface at the given level.

7.3 Rotationally averaged power spectrum [i](#)

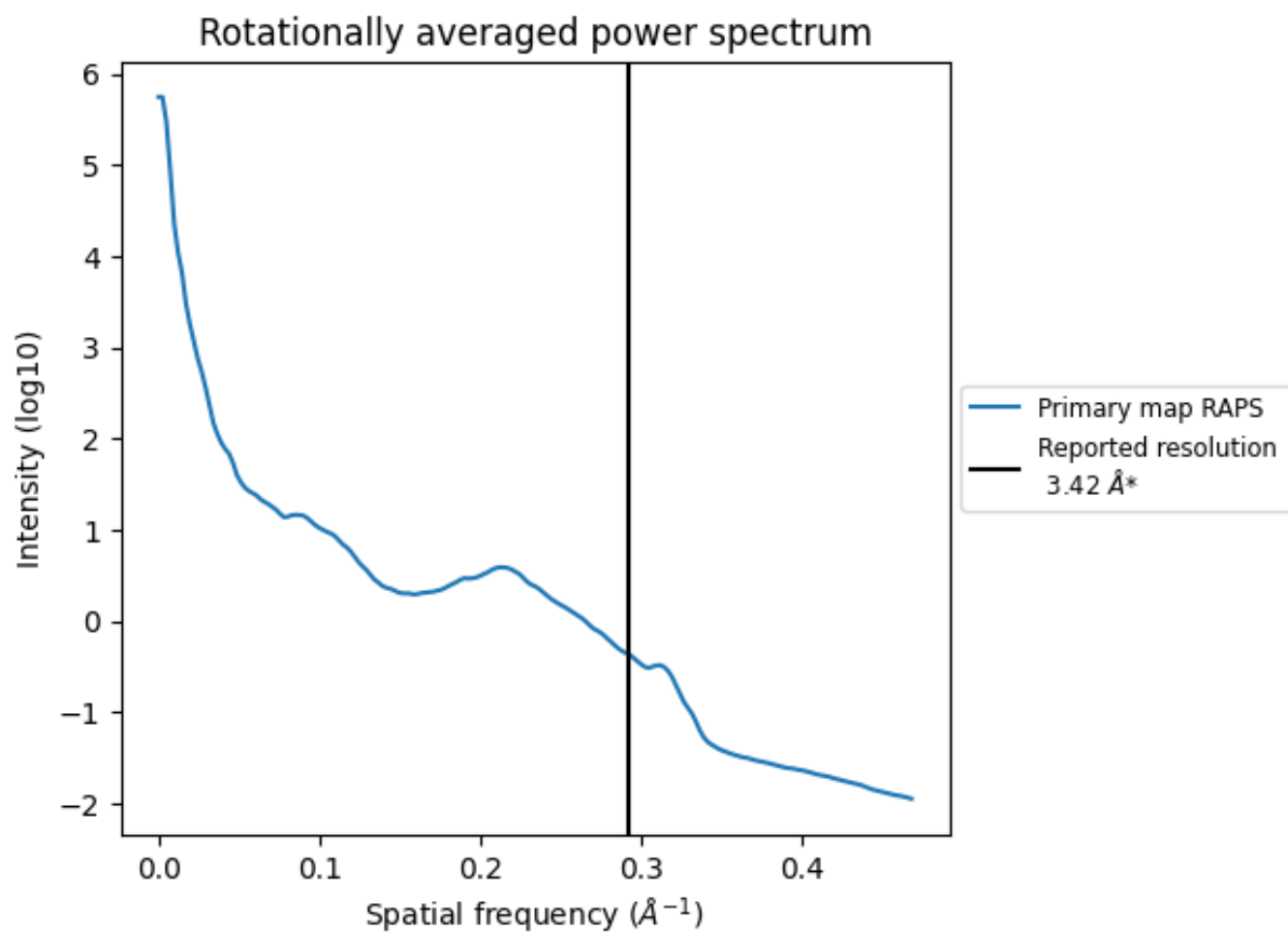

*Reported resolution corresponds to spatial frequency of 0.292 Å⁻¹

8 Fourier-Shell correlation

This section was not generated. No FSC curve or half-maps provided.

9 Map-model fit [i](#)

This section contains information regarding the fit between EMDB map EMD-24063 and PDB model 7MW5. Per-residue inclusion information can be found in section 3 on page 16.

9.1 Map-model overlay [i](#)

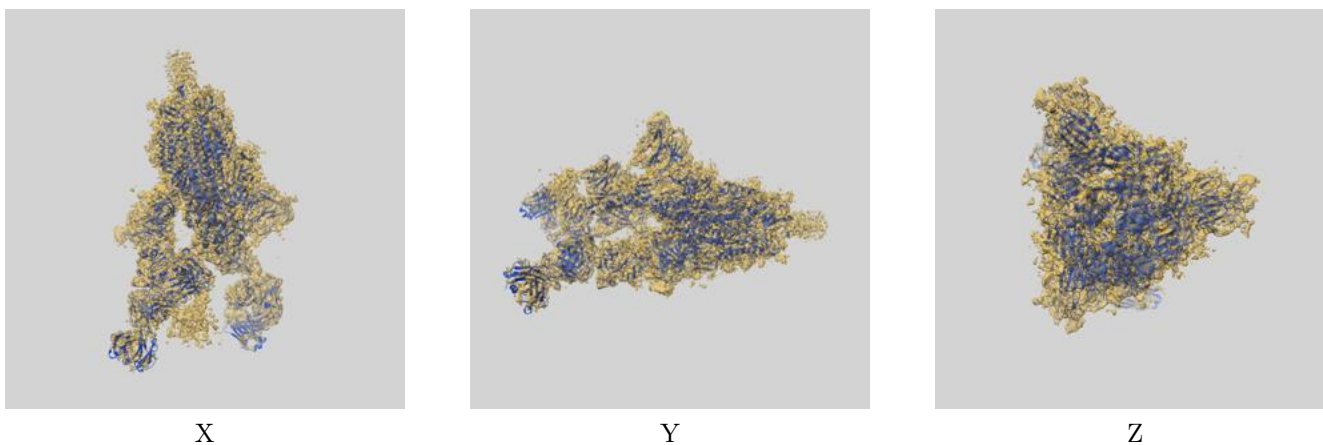

The images above show the 3D surface view of the map at the recommended contour level 0.022 at 50% transparency in yellow overlaid with a ribbon representation of the model coloured in blue. These images allow for the visual assessment of the quality of fit between the atomic model and the map.

9.2 Q-score mapped to coordinate model [i](#)

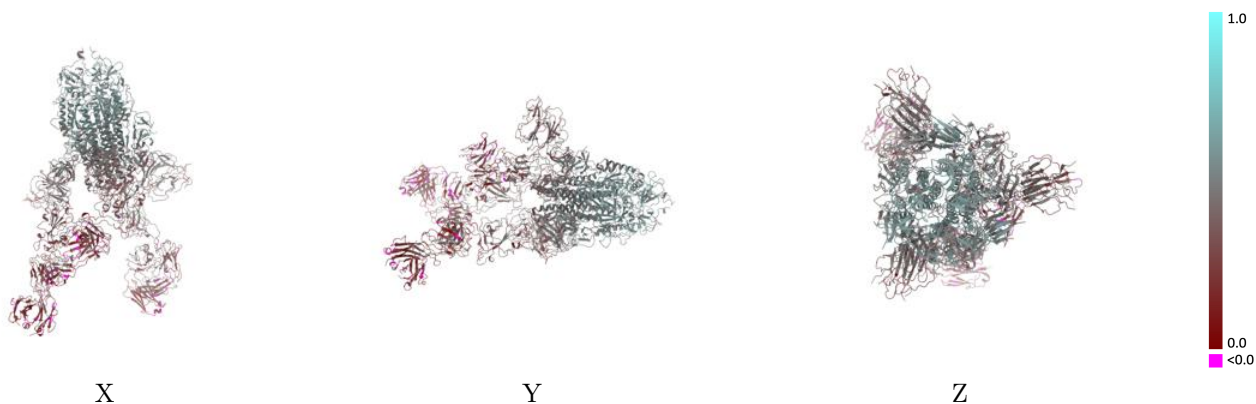

The images above show the model with each residue coloured according to its Q-score. This shows their resolvability in the map with higher Q-score values reflecting better resolvability. Please note: Q-score is calculating the resolvability of atoms, and thus high values are only expected at resolutions at which atoms can be resolved. Low Q-score values may therefore be expected for many entries.

9.3 Atom inclusion mapped to coordinate model [i](#)

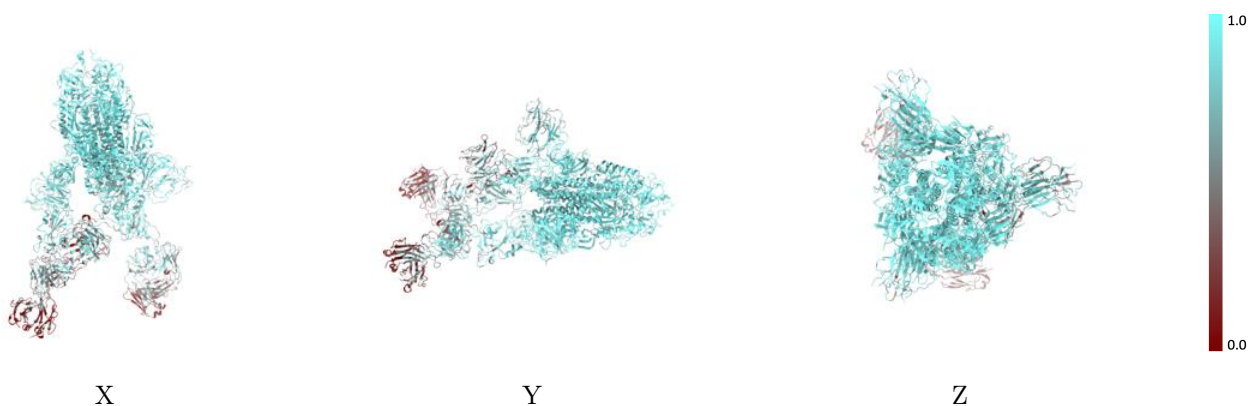

The images above show the model with each residue coloured according to its atom inclusion. This shows to what extent they are inside the map at the recommended contour level (0.022).



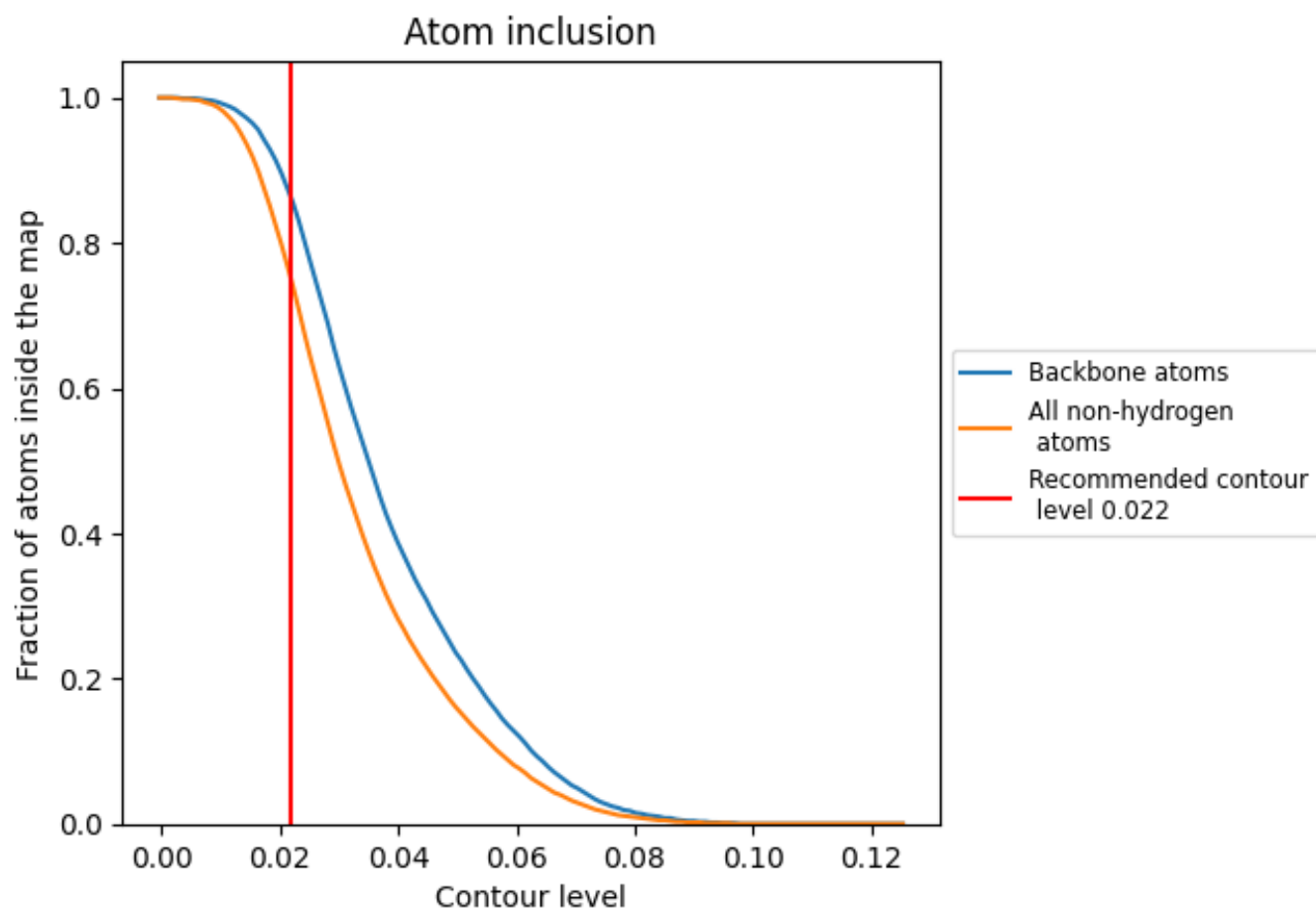



































































9.4 Atom inclusion [i](#)



At the recommended contour level, 86% of all backbone atoms, 75% of all non-hydrogen atoms, are inside the map.

9.5 Map-model fit summary









The table lists the average atom inclusion at the recommended contour level (0.022) and Q-score for the entire model and for each chain.

Chain	Atom inclusion	Q-score
All	 0.7470	 0.3980
A	 0.8580	 0.4580
B	 0.8200	 0.4370
C	 0.8600	 0.4500
D	 0.4730	 0.2340
E	 0.5090	 0.2410
F	 0.4060	 0.2150
G	 0.3780	 0.2150
H	 0.5040	 0.2630
I	 0.5360	 0.3010
J	 0.4290	 0.2450
K	 0.8570	 0.4140
L	 0.4930	 0.2780
M	 0.5710	 0.3140
N	 0.7860	 0.4890
O	 0.7500	 0.4750
P	 0.8930	 0.5300
Q	 0.3930	 0.3170
R	 0.6430	 0.3620
S	 0.6070	 0.4130
T	 0.4290	 0.3150
U	 0.7860	 0.3710
V	 0.5000	 0.3580
W	 0.8570	 0.4900
X	 0.6790	 0.4450
Y	 0.8570	 0.4950
Z	 0.3930	 0.4370
a	 0.4290	 0.2800
b	 0.6430	 0.3980
c	 0.6430	 0.4610
d	 0.6430	 0.3660
e	 0.7140	 0.3870
f	 0.5000	 0.3080
g	 0.7860	 0.4740
h	 0.7860	 0.5210



Continued on next page...

Continued from previous page...

Chain	Atom inclusion	Q-score
i	 0.7860	 0.4760
j	 0.3210	 0.4040
k	 0.5710	 0.3230
l	 0.6070	 0.3440