



Full wwPDB EM Validation Report ⓘ

Oct 28, 2024 – 10:28 pm GMT

PDB ID : 6ZIY
EMDB ID : EMD-11231
Title : Respiratory complex I from *Thermus thermophilus*, NADH dataset, major state
Authors : Kaszuba, K.; Tambalo, M.; Gallagher, G.T.; Sazanov, L.A.
Deposited on : 2020-06-26
Resolution : 4.25 Å (reported)
Based on initial model : 6Y11

This is a Full wwPDB EM Validation Report for a publicly released PDB entry.

We welcome your comments at validation@mail.wwpdb.org

A user guide is available at

<https://www.wwpdb.org/validation/2017/EMValidationReportHelp>

with specific help available everywhere you see the ⓘ symbol.

The types of validation reports are described at

<http://www.wwpdb.org/validation/2017/FAQs#types>.

The following versions of software and data (see [references ⓘ](#)) were used in the production of this report:

EMDB validation analysis : 0.0.1.dev113
Mogul : 1.8.4, CSD as541be (2020)
MolProbity : 4.02b-467
buster-report : 1.1.7 (2018)
Percentile statistics : 20231227.v01 (using entries in the PDB archive December 27th 2023)
MapQ : 1.9.13
Ideal geometry (proteins) : Engh & Huber (2001)
Ideal geometry (DNA, RNA) : Parkinson et al. (1996)
Validation Pipeline (wwPDB-VP) : 2.39

1 Overall quality at a glance i

The following experimental techniques were used to determine the structure:

ELECTRON MICROSCOPY

The reported resolution of this entry is 4.25 Å.

Percentile scores (ranging between 0-100) for global validation metrics of the entry are shown in the following graphic. The table shows the number of entries on which the scores are based.

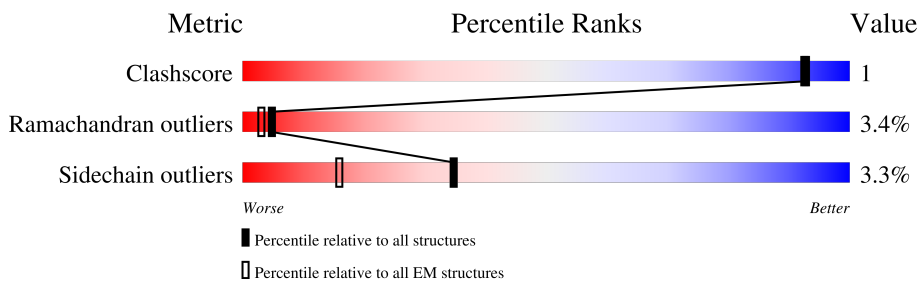

Metric	Whole archive (#Entries)	EM structures (#Entries)
Clashscore	210492	15764
Ramachandran outliers	207382	16835
Sidechain outliers	206894	16415

The table below summarises the geometric issues observed across the polymeric chains and their fit to the map. The red, orange, yellow and green segments of the bar indicate the fraction of residues that contain outliers for ≥ 3 , 2, 1 and 0 types of geometric quality criteria respectively. A grey segment represents the fraction of residues that are not modelled. The numeric value for each fraction is indicated below the corresponding segment, with a dot representing fractions $\leq 5\%$. The upper red bar (where present) indicates the fraction of residues that have poor fit to the EM map (all-atom inclusion $< 40\%$). The numeric value is given above the bar.

Mol	Chain	Length	Quality of chain
1	1	438	21% 87% 10% ..
2	2	181	20% 90% 8% ..
3	3	783	23% 81% 14% ..
4	4	409	11% 83% 11% . 6%
5	5	207	13% 83% 11% 5%
6	6	181	14% 78% 13% . 8%
7	9	182	7% 88% 9% ..
8	7	129	23% 88% 9% ..

Continued on next page...

Continued from previous page...

Mol	Chain	Length	Quality of chain
9	A	119	
10	J	176	
11	K	95	
12	L	606	
13	M	469	
14	N	427	
15	H	365	

2 Entry composition i

There are 19 unique types of molecules in this entry. The entry contains 36101 atoms, of which 0 are hydrogens and 0 are deuteriums.

In the tables below, the AltConf column contains the number of residues with at least one atom in alternate conformation and the Trace column contains the number of residues modelled with at most 2 atoms.

- Molecule 1 is a protein called NADH-quinone oxidoreductase subunit 1.

Mol	Chain	Residues	Atoms					AltConf	Trace
			Total	C	N	O	S		
1	1	437	3417	2180	595	624	18	0	0

- Molecule 2 is a protein called NADH-quinone oxidoreductase subunit 2.

Mol	Chain	Residues	Atoms					AltConf	Trace
			Total	C	N	O	S		
2	2	178	1406	895	238	265	8	0	0

- Molecule 3 is a protein called NADH-quinone oxidoreductase subunit 3.

Mol	Chain	Residues	Atoms					AltConf	Trace
			Total	C	N	O	S		
3	3	754	5876	3740	1055	1050	31	0	0

- Molecule 4 is a protein called NADH-quinone oxidoreductase subunit 4.

Mol	Chain	Residues	Atoms					AltConf	Trace
			Total	C	N	O	S		
4	4	384	3067	1975	522	559	11	0	0

- Molecule 5 is a protein called NADH-quinone oxidoreductase subunit 5.

Mol	Chain	Residues	Atoms					AltConf	Trace
			Total	C	N	O	S		
5	5	196	1607	1043	273	288	3	0	0

- Molecule 6 is a protein called NADH-quinone oxidoreductase subunit 6.

Mol	Chain	Residues	Atoms					AltConf	Trace
			Total	C	N	O	S		
6	6	166	1289	815	235	226	13	0	0

- Molecule 7 is a protein called NADH-quinone oxidoreductase subunit 9.

Mol	Chain	Residues	Atoms					AltConf	Trace
			Total	C	N	O	S		
7	9	180	1388	890	232	255	11	0	0

- Molecule 8 is a protein called NADH-quinone oxidoreductase subunit 15.

Mol	Chain	Residues	Atoms					AltConf	Trace
			Total	C	N	O	S		
8	7	127	1031	664	183	181	3	0	0

- Molecule 9 is a protein called NADH-quinone oxidoreductase subunit 7.

Mol	Chain	Residues	Atoms					AltConf	Trace
			Total	C	N	O	S		
9	A	117	910	624	138	144	4	0	0

- Molecule 10 is a protein called NADH-quinone oxidoreductase subunit 10.

Mol	Chain	Residues	Atoms					AltConf	Trace
			Total	C	N	O	S		
10	J	160	1183	806	183	191	3	0	0

- Molecule 11 is a protein called NADH-quinone oxidoreductase subunit 11.

Mol	Chain	Residues	Atoms					AltConf	Trace
			Total	C	N	O	S		
11	K	95	703	456	118	126	3	0	0

- Molecule 12 is a protein called NADH-quinone oxidoreductase subunit 12.

Mol	Chain	Residues	Atoms					AltConf	Trace
			Total	C	N	O	S		
12	L	605	4604	3089	740	756	19	0	0

- Molecule 13 is a protein called NADH-quinone oxidoreductase subunit 13.

Mol	Chain	Residues	Atoms					AltConf	Trace
			Total	C	N	O	S		
13	M	467	3489	2363	546	572	8	0	0

- Molecule 14 is a protein called NADH-quinone oxidoreductase subunit 14.

Mol	Chain	Residues	Atoms					AltConf	Trace
			Total	C	N	O	S		
14	N	427	3154	2125	505	518	6	0	0

- Molecule 15 is a protein called NADH-quinone oxidoreductase subunit 8.

Mol	Chain	Residues	Atoms					AltConf	Trace
			Total	C	N	O	S		
15	H	353	2838	1943	431	457	7	0	0

- Molecule 16 is IRON/SULFUR CLUSTER (three-letter code: SF4) (formula: Fe₄S₄).

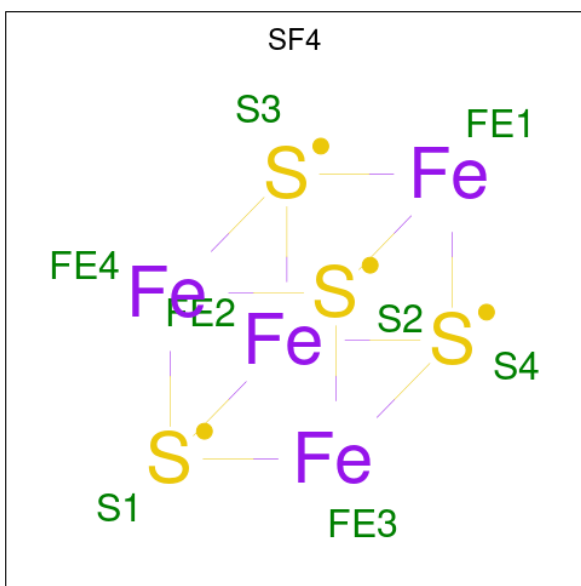

Mol	Chain	Residues	Atoms			AltConf
			Total	Fe	S	
16	1	1	8	4	4	0
16	3	1	8	4	4	0
16	3	1	8	4	4	0
16	3	1	8	4	4	0
16	6	1	8	4	4	0
16	9	1	8	4	4	0
16	9	1	8	4	4	0

- Molecule 17 is FLAVIN MONONUCLEOTIDE (three-letter code: FMN) (formula: C₁₇H₂₁N₄O₉P).



Mol	Chain	Residues	Atoms					AltConf
			Total	C	N	O	P	
17	1	1	31	17	4	9	1	0

- Molecule 18 is 1,4-DIHYDRONICOTINAMIDE ADENINE DINUCLEOTIDE (three-letter code: NAI) (formula: $C_{21}H_{29}N_7O_{14}P_2$).

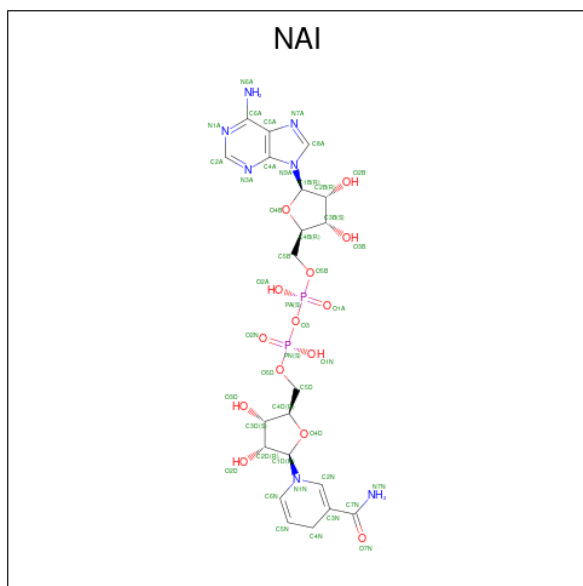

Mol	Chain	Residues	Atoms					AltConf
			Total	C	N	O	P	
18	1	1	44	21	7	14	2	0

- Molecule 19 is FE2/S2 (INORGANIC) CLUSTER (three-letter code: FES) (formula: Fe_2S_2).

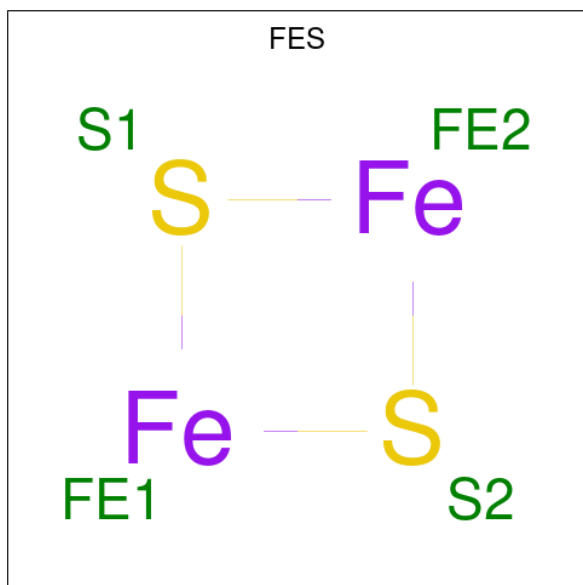

Mol	Chain	Residues	Atoms			AltConf
			Total	Fe	S	
19	2	1	4	2	2	0
19	3	1	4	2	2	0

3 Residue-property plots

These plots are drawn for all protein, RNA, DNA and oligosaccharide chains in the entry. The first graphic for a chain summarises the proportions of the various outlier classes displayed in the second graphic. The second graphic shows the sequence view annotated by issues in geometry and atom inclusion in map density. Residues are color-coded according to the number of geometric quality criteria for which they contain at least one outlier: green = 0, yellow = 1, orange = 2 and red = 3 or more. A red diamond above a residue indicates a poor fit to the EM map for this residue (all-atom inclusion < 40%). Stretches of 2 or more consecutive residues without any outlier are shown as a green connector. Residues present in the sample, but not in the model, are shown in grey.

- Molecule 1: NADH-quinone oxidoreductase subunit 1

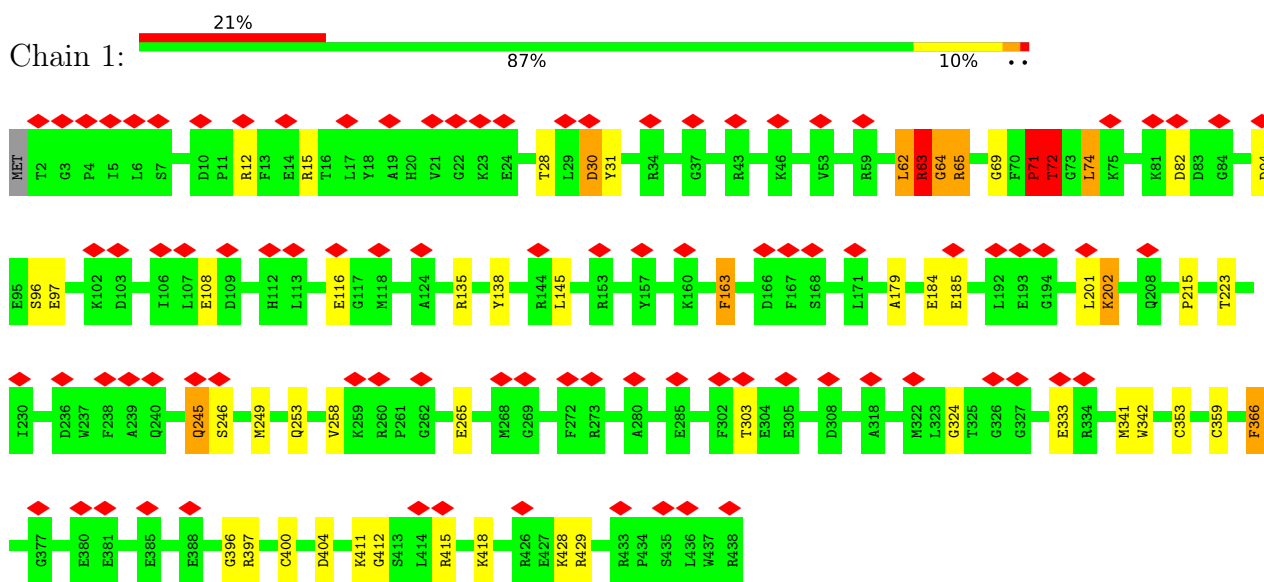

- Molecule 2: NADH-quinone oxidoreductase subunit 2

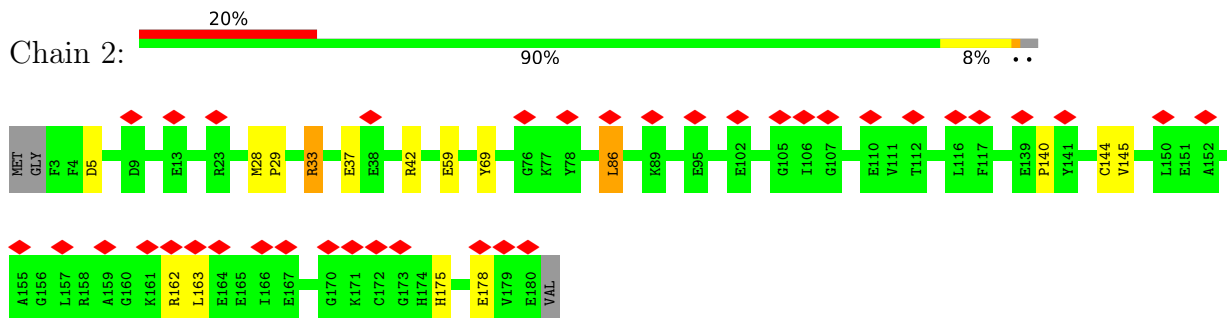

- Molecule 3: NADH-quinone oxidoreductase subunit 3

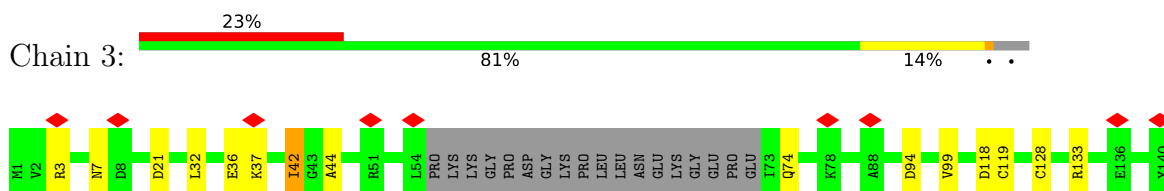

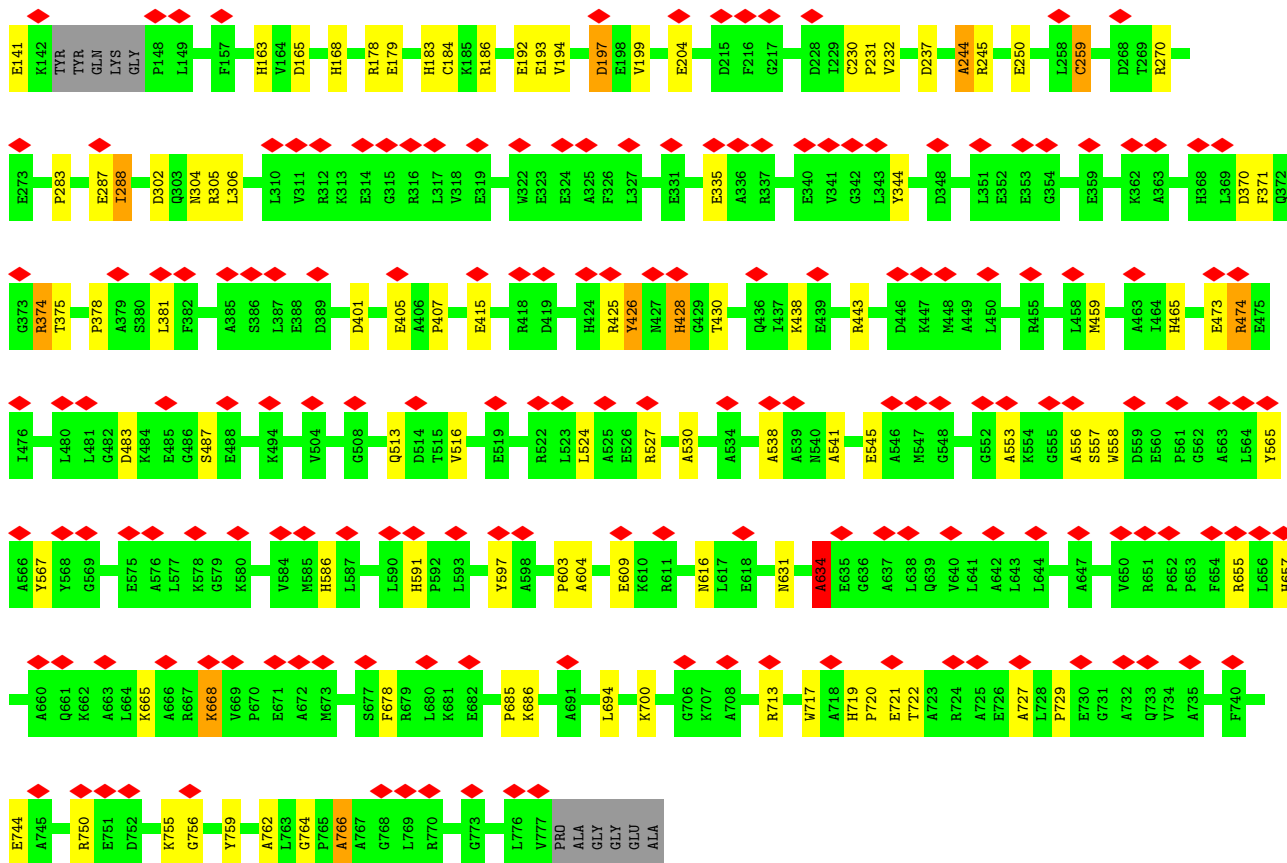

• Molecule 4: NADH-quinone oxidoreductase subunit 4

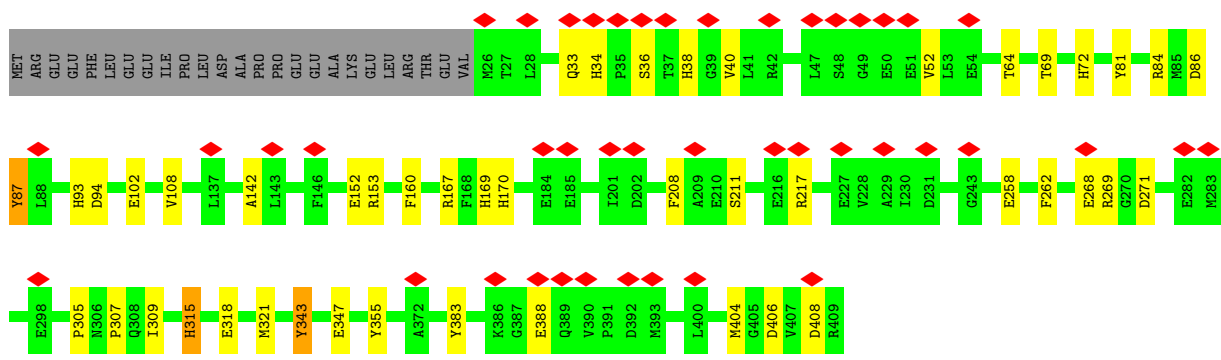
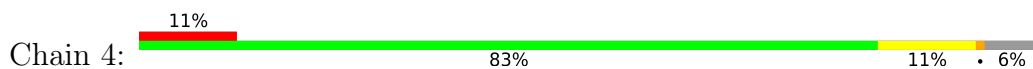

• Molecule 5: NADH-quinone oxidoreductase subunit 5

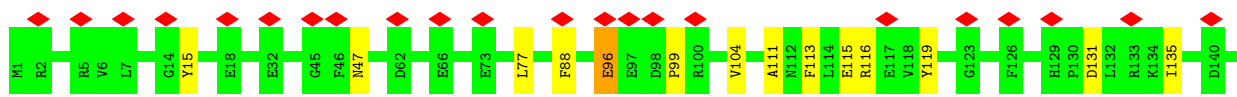
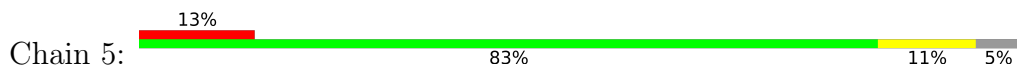

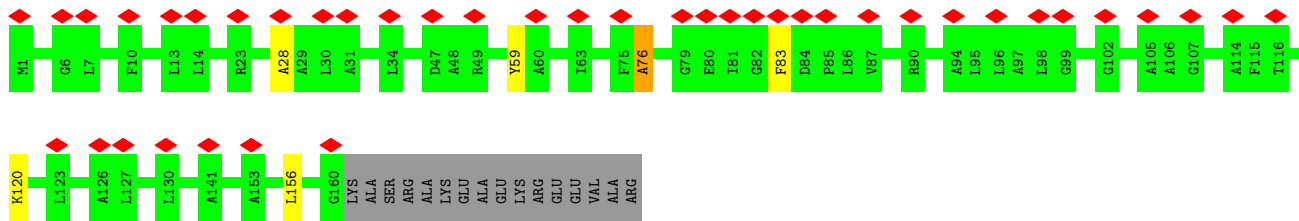

• Molecule 11: NADH-quinone oxidoreductase subunit 11

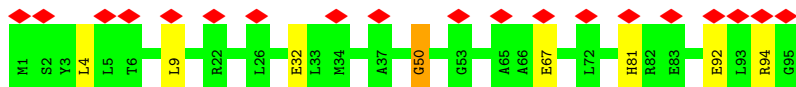
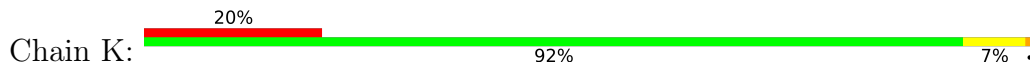

• Molecule 12: NADH-quinone oxidoreductase subunit 12

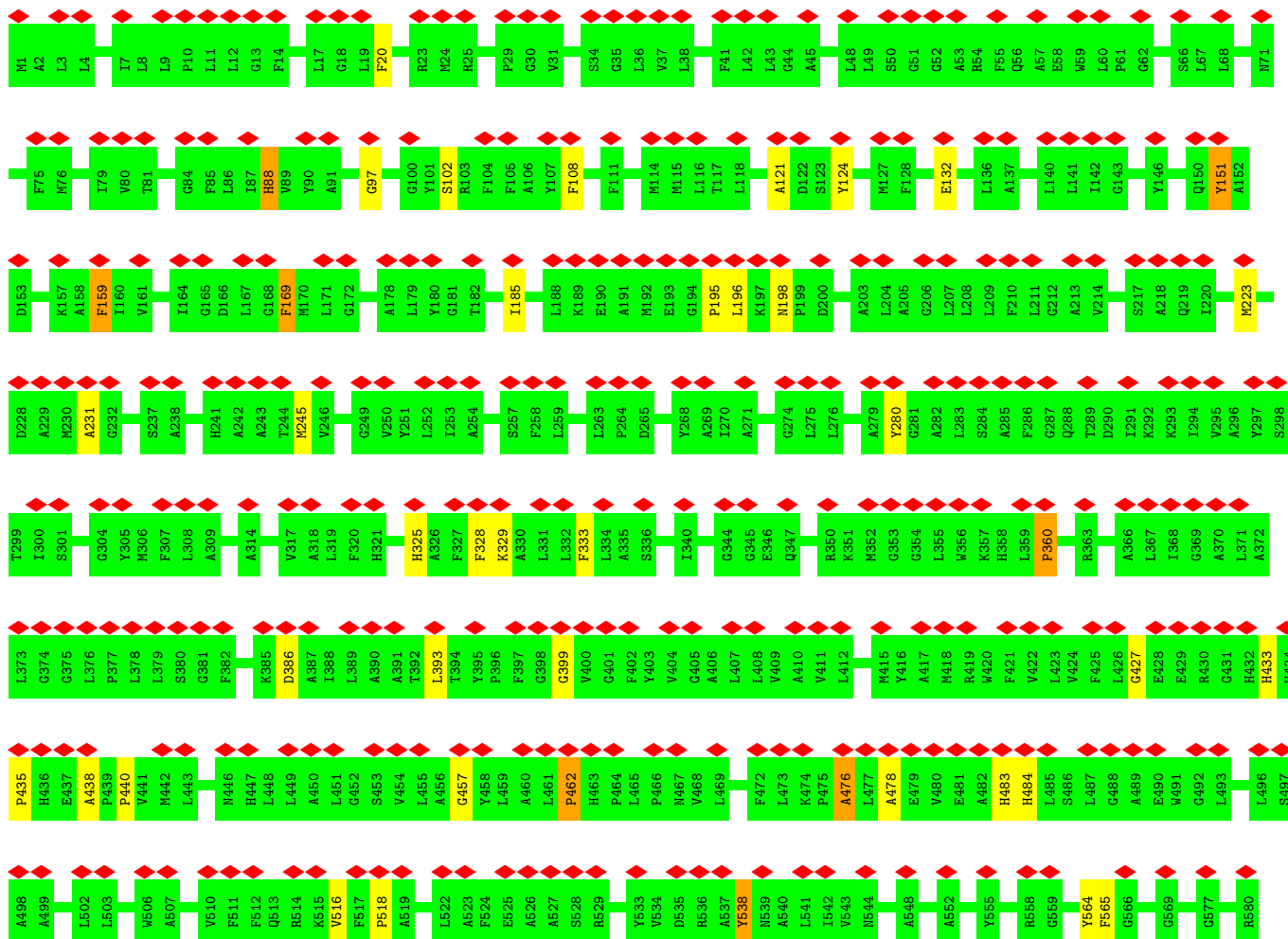
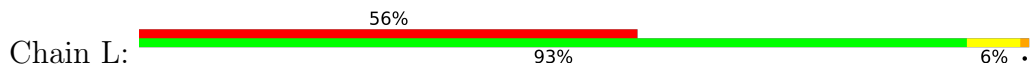

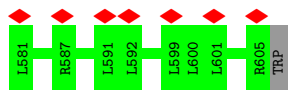

- Molecule 13: NADH-quinone oxidoreductase subunit 13

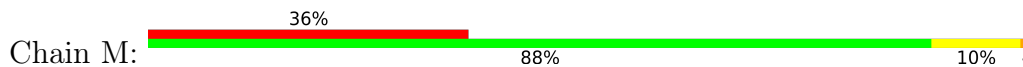

- Molecule 14: NADH-quinone oxidoreductase subunit 14

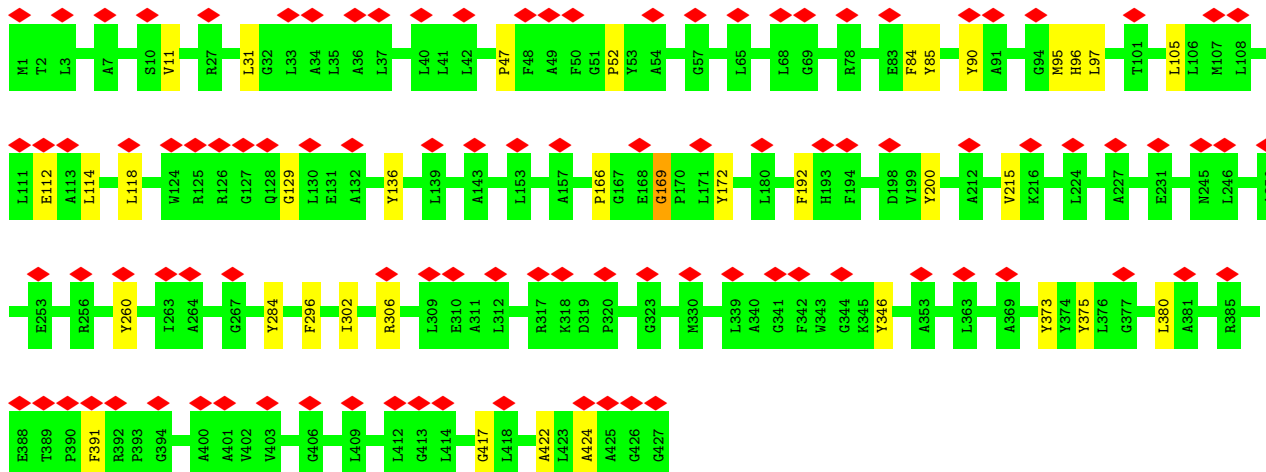

- Molecule 15: NADH-quinone oxidoreductase subunit 8

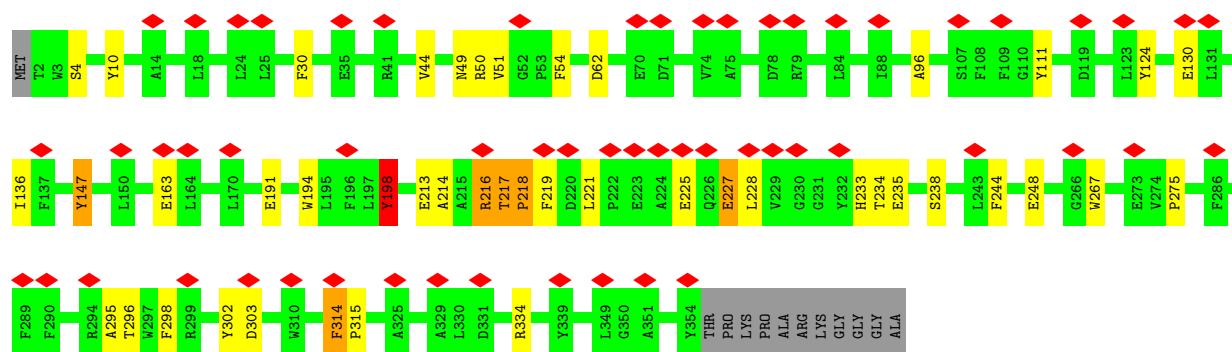
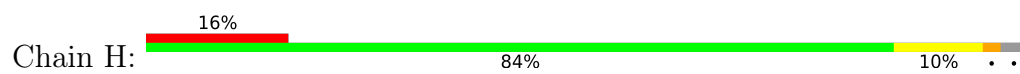

4 Experimental information

Property	Value	Source
EM reconstruction method	SINGLE PARTICLE	Depositor
Imposed symmetry	POINT, C1	Depositor
Number of particles used	44500	Depositor
Resolution determination method	FSC 0.143 CUT-OFF	Depositor
CTF correction method	PHASE FLIPPING AND AMPLITUDE CORRECTION	Depositor
Microscope	FEI TITAN KRIOS	Depositor
Voltage (kV)	300	Depositor
Electron dose ($e^-/\text{\AA}^2$)	34	Depositor
Minimum defocus (nm)	2500	Depositor
Maximum defocus (nm)	4000	Depositor
Magnification	Not provided	
Image detector	FEI FALCON II (4k x 4k)	Depositor
Maximum map value	1.906	Depositor
Minimum map value	-0.659	Depositor
Average map value	0.000	Depositor
Map value standard deviation	0.045	Depositor
Recommended contour level	0.24	Depositor
Map size (\AA)	880.64, 880.64, 880.64	wwPDB
Map dimensions	512, 512, 512	wwPDB
Map angles ($^\circ$)	90.0, 90.0, 90.0	wwPDB
Pixel spacing (\AA)	1.72, 1.72, 1.72	Depositor

5 Model quality i

5.1 Standard geometry i

Bond lengths and bond angles in the following residue types are not validated in this section: FMN, FES, NAI, SF4

The Z score for a bond length (or angle) is the number of standard deviations the observed value is removed from the expected value. A bond length (or angle) with $|Z| > 5$ is considered an outlier worth inspection. RMSZ is the root-mean-square of all Z scores of the bond lengths (or angles).

Mol	Chain	Bond lengths		Bond angles	
		RMSZ	# Z >5	RMSZ	# Z >5
1	1	1.07	5/3506 (0.1%)	1.17	9/4745 (0.2%)
2	2	1.03	1/1439 (0.1%)	1.11	0/1953
3	3	1.18	16/6014 (0.3%)	1.22	19/8155 (0.2%)
4	4	1.15	8/3150 (0.3%)	1.24	10/4284 (0.2%)
5	5	1.10	1/1656 (0.1%)	1.18	3/2246 (0.1%)
6	6	1.23	4/1319 (0.3%)	1.31	9/1786 (0.5%)
7	9	1.15	2/1423 (0.1%)	1.22	3/1933 (0.2%)
8	7	1.13	1/1059 (0.1%)	1.16	2/1429 (0.1%)
9	A	1.29	5/940 (0.5%)	1.20	7/1280 (0.5%)
10	J	0.94	0/1206	1.09	3/1649 (0.2%)
11	K	1.21	2/710 (0.3%)	1.11	0/962
12	L	0.96	2/4741 (0.0%)	1.11	15/6460 (0.2%)
13	M	1.05	6/3591 (0.2%)	1.09	11/4896 (0.2%)
14	N	1.00	1/3238 (0.0%)	1.10	8/4434 (0.2%)
15	H	1.17	9/2935 (0.3%)	1.21	21/4014 (0.5%)
All	All	1.10	63/36927 (0.2%)	1.17	120/50226 (0.2%)

Chiral center outliers are detected by calculating the chiral volume of a chiral center and verifying if the center is modelled as a planar moiety or with the opposite hand. A planarity outlier is detected by checking planarity of atoms in a peptide group, atoms in a mainchain group or atoms of a sidechain that are expected to be planar.

Mol	Chain	#Chirality outliers	#Planarity outliers
1	1	0	5
2	2	0	3
3	3	0	13
4	4	0	8
5	5	0	5
6	6	0	6
7	9	0	2
8	7	0	2

Continued on next page...

Continued from previous page...

Mol	Chain	#Chirality outliers	#Planarity outliers
9	A	0	2
10	J	0	1
11	K	0	1
12	L	0	4
13	M	0	4
14	N	0	10
15	H	0	10
All	All	0	76

All (63) bond length outliers are listed below:

Mol	Chain	Res	Type	Atoms	Z	Observed(Å)	Ideal(Å)
3	3	192	GLU	CD-OE2	13.26	1.40	1.25
15	H	225	GLU	CD-OE2	12.92	1.39	1.25
9	A	110	GLU	CD-OE2	12.84	1.39	1.25
11	K	32	GLU	CD-OE2	12.83	1.39	1.25
7	9	92	GLU	CD-OE2	12.78	1.39	1.25
12	L	132	GLU	CD-OE2	12.77	1.39	1.25
15	H	235	GLU	CD-OE2	12.73	1.39	1.25
4	4	102	GLU	CD-OE2	12.72	1.39	1.25
3	3	250	GLU	CD-OE2	12.59	1.39	1.25
9	A	74	GLU	CD-OE2	12.56	1.39	1.25
15	H	130	GLU	CD-OE2	12.52	1.39	1.25
15	H	248	GLU	CD-OE2	12.51	1.39	1.25
3	3	609	GLU	CD-OE2	12.48	1.39	1.25
4	4	347	GLU	CD-OE2	12.45	1.39	1.25
1	1	108	GLU	CD-OE2	12.37	1.39	1.25
13	M	123	GLU	CD-OE2	12.36	1.39	1.25
13	M	377	GLU	CD-OE2	12.35	1.39	1.25
11	K	67	GLU	CD-OE2	12.30	1.39	1.25
14	N	112	GLU	CD-OE2	12.30	1.39	1.25
3	3	36	GLU	CD-OE2	12.27	1.39	1.25
6	6	49	GLU	CD-OE2	12.27	1.39	1.25
4	4	388	GLU	CD-OE2	12.27	1.39	1.25
15	H	163	GLU	CD-OE2	12.26	1.39	1.25
3	3	405	GLU	CD-OE2	12.21	1.39	1.25
13	M	92	GLU	CD-OE2	12.21	1.39	1.25
3	3	179	GLU	CD-OE2	12.21	1.39	1.25
2	2	59	GLU	CD-OE2	12.17	1.39	1.25
15	H	213	GLU	CD-OE2	12.16	1.39	1.25
3	3	545	GLU	CD-OE2	12.15	1.39	1.25
1	1	265	GLU	CD-OE2	12.14	1.39	1.25

Continued on next page...

Continued from previous page...

Mol	Chain	Res	Type	Atoms	Z	Observed(Å)	Ideal(Å)
4	4	152	GLU	CD-OE2	12.05	1.39	1.25
13	M	103	GLU	CD-OE2	12.03	1.38	1.25
9	A	45	GLU	CD-OE2	12.01	1.38	1.25
9	A	6	GLU	CD-OE2	12.00	1.38	1.25
1	1	116	GLU	CD-OE2	11.87	1.38	1.25
3	3	473	GLU	CD-OE2	11.80	1.38	1.25
3	3	415	GLU	CD-OE2	11.75	1.38	1.25
15	H	227	GLU	CD-OE2	11.75	1.38	1.25
3	3	193	GLU	CD-OE2	11.69	1.38	1.25
5	5	115	GLU	CD-OE2	11.60	1.38	1.25
8	7	34	GLU	CD-OE2	11.47	1.38	1.25
12	L	386	ASP	CG-OD2	6.44	1.40	1.25
1	1	404	ASP	CG-OD2	6.25	1.39	1.25
15	H	303	ASP	CG-OD2	6.11	1.39	1.25
13	M	114	ASP	CG-OD2	6.11	1.39	1.25
15	H	62	ASP	CG-OD2	6.10	1.39	1.25
3	3	302	ASP	CG-OD2	6.04	1.39	1.25
3	3	370	ASP	CG-OD2	6.04	1.39	1.25
3	3	21	ASP	CG-OD2	6.01	1.39	1.25
13	M	228	ASP	CG-OD2	6.01	1.39	1.25
4	4	406	ASP	CG-OD2	6.01	1.39	1.25
3	3	197	ASP	CG-OD2	5.93	1.39	1.25
1	1	94	ASP	CG-OD2	5.92	1.39	1.25
4	4	94	ASP	CG-OD2	5.91	1.39	1.25
6	6	55	ASP	CG-OD2	5.89	1.38	1.25
3	3	237	ASP	CG-OD2	5.87	1.38	1.25
9	A	72	ASP	CG-OD2	5.86	1.38	1.25
6	6	59	ASP	CG-OD2	5.76	1.38	1.25
4	4	408	ASP	CG-OD2	5.75	1.38	1.25
4	4	271	ASP	CG-OD2	5.74	1.38	1.25
3	3	401	ASP	CG-OD2	5.71	1.38	1.25
6	6	134	ASP	CG-OD2	5.69	1.38	1.25
7	9	104	CYS	CB-SG	-5.27	1.73	1.81

All (120) bond angle outliers are listed below:

Mol	Chain	Res	Type	Atoms	Z	Observed(°)	Ideal(°)
3	3	237	ASP	CB-CG-OD1	9.91	127.22	118.30
12	L	386	ASP	CB-CG-OD1	9.37	126.74	118.30
14	N	200	TYR	CB-CG-CD2	-8.95	115.63	121.00
6	6	55	ASP	CB-CG-OD1	8.85	126.27	118.30
4	4	271	ASP	CB-CG-OD1	8.83	126.25	118.30

Continued on next page...

Continued from previous page...

Mol	Chain	Res	Type	Atoms	Z	Observed(°)	Ideal(°)
6	6	134	ASP	CB-CG-OD1	8.77	126.19	118.30
4	4	408	ASP	CB-CG-OD1	8.58	126.02	118.30
3	3	302	ASP	CB-CG-OD1	8.57	126.02	118.30
3	3	21	ASP	CB-CG-OD1	8.35	125.81	118.30
4	4	406	ASP	CB-CG-OD1	8.34	125.81	118.30
3	3	237	ASP	CB-CG-OD2	-8.34	110.80	118.30
1	1	404	ASP	CB-CG-OD1	8.33	125.80	118.30
1	1	94	ASP	CB-CG-OD1	8.31	125.78	118.30
15	H	62	ASP	CB-CG-OD1	8.01	125.51	118.30
6	6	134	ASP	CB-CG-OD2	-8.00	111.10	118.30
9	A	72	ASP	CB-CG-OD1	7.98	125.48	118.30
14	N	200	TYR	CB-CG-CD1	7.87	125.72	121.00
14	N	90	TYR	CB-CG-CD2	-7.86	116.29	121.00
4	4	94	ASP	CB-CG-OD1	7.81	125.33	118.30
4	4	271	ASP	CB-CG-OD2	-7.77	111.30	118.30
3	3	197	ASP	CB-CG-OD1	7.68	125.21	118.30
13	M	228	ASP	CB-CG-OD1	7.60	125.14	118.30
3	3	370	ASP	CB-CG-OD1	7.60	125.14	118.30
12	L	538	TYR	CB-CG-CD1	-7.58	116.45	121.00
13	M	114	ASP	CB-CG-OD1	7.50	125.05	118.30
1	1	72	THR	CB-CA-C	-7.41	91.60	111.60
15	H	303	ASP	CB-CG-OD1	7.39	124.95	118.30
6	6	59	ASP	CB-CG-OD1	7.16	124.75	118.30
12	L	565	PHE	CB-CG-CD2	-7.12	115.82	120.80
3	3	401	ASP	CB-CG-OD1	7.12	124.70	118.30
6	6	55	ASP	CB-CG-OD2	-7.10	111.91	118.30
12	L	427	GLY	N-CA-C	-7.04	95.49	113.10
3	3	766	ALA	N-CA-CB	7.02	119.93	110.10
4	4	408	ASP	CB-CG-OD2	-7.00	112.00	118.30
15	H	216	ARG	N-CA-CB	6.91	123.03	110.60
12	L	565	PHE	CB-CG-CD1	6.90	125.63	120.80
14	N	90	TYR	CB-CG-CD1	6.89	125.14	121.00
1	1	366	PHE	CB-CG-CD1	-6.87	115.99	120.80
15	H	147	TYR	CB-CG-CD1	6.82	125.09	121.00
15	H	10	TYR	CB-CG-CD1	-6.81	116.91	121.00
4	4	406	ASP	CB-CG-OD2	-6.78	112.20	118.30
12	L	386	ASP	CB-CG-OD2	-6.76	112.21	118.30
7	9	117	TYR	CB-CG-CD2	-6.74	116.95	121.00
15	H	30	PHE	CB-CG-CD1	-6.69	116.11	120.80
3	3	21	ASP	CB-CG-OD2	-6.68	112.28	118.30
15	H	147	TYR	CB-CG-CD2	-6.65	117.01	121.00
7	9	104	CYS	N-CA-CB	6.60	122.48	110.60

Continued on next page...

Continued from previous page...

Mol	Chain	Res	Type	Atoms	Z	Observed(°)	Ideal(°)
3	3	302	ASP	CB-CG-OD2	-6.59	112.37	118.30
4	4	94	ASP	CB-CG-OD2	-6.59	112.37	118.30
1	1	366	PHE	CB-CG-CD2	6.59	125.41	120.80
1	1	94	ASP	CB-CG-OD2	-6.58	112.38	118.30
15	H	314	PHE	N-CA-CB	6.54	122.37	110.60
15	H	54	PHE	CB-CG-CD1	-6.53	116.23	120.80
14	N	95	MET	CG-SD-CE	-6.49	89.82	100.20
12	L	151	TYR	CB-CG-CD1	-6.47	117.12	121.00
15	H	298	PHE	CB-CG-CD1	6.34	125.24	120.80
15	H	314	PHE	CB-CG-CD2	-6.34	116.36	120.80
12	L	151	TYR	CB-CG-CD2	6.32	124.79	121.00
3	3	197	ASP	CB-CG-OD2	-6.30	112.63	118.30
14	N	84	PHE	CB-CG-CD1	6.27	125.19	120.80
15	H	198	TYR	CB-CG-CD1	-6.23	117.26	121.00
15	H	30	PHE	CB-CG-CD2	6.23	125.16	120.80
12	L	159	PHE	CB-CG-CD1	6.15	125.11	120.80
13	M	293	MET	CG-SD-CE	-6.08	90.47	100.20
9	A	72	ASP	CB-CG-OD2	-6.07	112.84	118.30
1	1	138	TYR	CB-CG-CD2	-6.06	117.36	121.00
12	L	476	ALA	N-CA-CB	6.06	118.58	110.10
8	7	116	PHE	CB-CG-CD1	6.04	125.03	120.80
9	A	116	MET	CG-SD-CE	-6.03	90.56	100.20
3	3	42	ILE	N-CA-C	-5.97	94.88	111.00
3	3	401	ASP	CB-CG-OD2	-5.95	112.95	118.30
6	6	59	ASP	CB-CG-OD2	-5.93	112.96	118.30
5	5	15	TYR	CB-CG-CD2	-5.88	117.47	121.00
8	7	116	PHE	CB-CG-CD2	-5.88	116.68	120.80
12	L	169	PHE	CB-CG-CD2	5.84	124.89	120.80
12	L	538	TYR	CB-CG-CD2	5.83	124.50	121.00
13	M	114	ASP	CB-CG-OD2	-5.78	113.10	118.30
13	M	33	PHE	CB-CG-CD2	-5.70	116.81	120.80
15	H	62	ASP	CB-CG-OD2	-5.67	113.19	118.30
10	J	156	LEU	CB-CA-C	-5.66	99.44	110.20
12	L	564	TYR	CB-CG-CD1	-5.65	117.61	121.00
15	H	303	ASP	CB-CG-OD2	-5.64	113.22	118.30
12	L	124	TYR	CB-CG-CD2	-5.63	117.62	121.00
15	H	298	PHE	CB-CG-CD2	-5.62	116.86	120.80
13	M	33	PHE	CB-CG-CD1	5.62	124.73	120.80
13	M	119	TYR	CB-CG-CD2	-5.62	117.63	121.00
9	A	44	TYR	CB-CG-CD2	-5.61	117.63	121.00
5	5	113	PHE	CB-CG-CD1	5.58	124.71	120.80
3	3	565	TYR	CB-CG-CD2	-5.53	117.68	121.00

Continued on next page...

Continued from previous page...

Mol	Chain	Res	Type	Atoms	Z	Observed(°)	Ideal(°)
12	L	159	PHE	CB-CG-CD2	-5.51	116.95	120.80
15	H	218	PRO	N-CA-C	-5.48	97.86	112.10
9	A	13	TYR	CB-CG-CD2	-5.47	117.72	121.00
6	6	46	CYS	N-CA-CB	5.46	120.42	110.60
3	3	370	ASP	CB-CG-OD2	-5.45	113.39	118.30
6	6	41	PHE	N-CA-C	-5.45	96.30	111.00
3	3	119	CYS	CA-CB-SG	-5.43	104.22	114.00
13	M	228	ASP	CB-CG-OD2	-5.43	113.42	118.30
1	1	404	ASP	CB-CG-OD2	-5.41	113.43	118.30
3	3	634	ALA	N-CA-CB	5.41	117.67	110.10
3	3	668	LYS	N-CA-CB	5.41	120.33	110.60
15	H	10	TYR	CB-CG-CD2	5.36	124.21	121.00
1	1	163	PHE	CB-CG-CD1	5.33	124.53	120.80
13	M	344	TYR	CA-CB-CG	-5.30	103.32	113.40
3	3	244	ALA	N-CA-CB	5.24	117.43	110.10
15	H	54	PHE	CB-CG-CD2	5.23	124.46	120.80
14	N	136	TYR	CB-CG-CD1	5.21	124.12	121.00
15	H	111	TYR	CB-CG-CD1	-5.17	117.90	121.00
9	A	81	TYR	CB-CG-CD1	-5.17	117.90	121.00
4	4	343	TYR	CB-CG-CD2	-5.16	117.90	121.00
10	J	76	ALA	N-CA-CB	5.15	117.31	110.10
15	H	314	PHE	CB-CG-CD1	5.11	124.38	120.80
13	M	292	HIS	CA-CB-CG	-5.11	104.92	113.60
14	N	84	PHE	CB-CG-CD2	-5.09	117.24	120.80
7	9	87	TYR	CB-CG-CD1	-5.09	117.95	121.00
10	J	76	ALA	N-CA-C	-5.05	97.37	111.00
4	4	321	MET	CG-SD-CE	-5.04	92.14	100.20
6	6	126	ASN	N-CA-CB	5.03	119.65	110.60
5	5	113	PHE	CB-CG-CD2	-5.02	117.28	120.80
9	A	7	TYR	CA-CB-CG	-5.01	103.87	113.40
13	M	102	MET	CG-SD-CE	-5.00	92.20	100.20

There are no chirality outliers.

All (76) planarity outliers are listed below:

Mol	Chain	Res	Type	Group
1	1	135	ARG	Sidechain
1	1	15	ARG	Sidechain
1	1	31	TYR	Sidechain
1	1	396	GLY	Peptide
1	1	429	ARG	Sidechain
2	2	162	ARG	Sidechain

Continued on next page...

Continued from previous page...

Mol	Chain	Res	Type	Group
2	2	33	ARG	Sidechain
2	2	69	TYR	Sidechain
3	3	183	HIS	Peptide
3	3	186	ARG	Sidechain
3	3	245	ARG	Sidechain
3	3	270	ARG	Sidechain
3	3	344	TYR	Sidechain
3	3	374	ARG	Sidechain
3	3	425	ARG	Sidechain
3	3	426	TYR	Sidechain
3	3	443	ARG	Sidechain
3	3	591	HIS	Sidechain
3	3	597	TYR	Sidechain
3	3	713	ARG	Sidechain
3	3	759	TYR	Sidechain
4	4	142	ALA	Peptide
4	4	167	ARG	Sidechain
4	4	208	PHE	Sidechain
4	4	343	TYR	Sidechain
4	4	355	TYR	Sidechain
4	4	36	SER	Peptide
4	4	383	TYR	Sidechain
4	4	84	ARG	Sidechain
5	5	119	TYR	Sidechain
5	5	144	HIS	Peptide
5	5	164	TYR	Sidechain
5	5	192	TYR	Sidechain
5	5	47	ASN	Peptide
6	6	136	TYR	Sidechain
6	6	159	ARG	Sidechain
6	6	175	ALA	Peptide
6	6	55	ASP	Peptide
6	6	62	ARG	Sidechain
6	6	83	ARG	Sidechain
8	7	21	ARG	Sidechain
8	7	42	TYR	Sidechain
7	9	152	ARG	Sidechain
7	9	21	PRO	Peptide
9	A	62	TYR	Sidechain
9	A	81	TYR	Sidechain
15	H	198	TYR	Sidechain
15	H	217	THR	Peptide

Continued on next page...

Continued from previous page...

Mol	Chain	Res	Type	Group
15	H	219	PHE	Peptide
15	H	221	LEU	Peptide
15	H	227	GLU	Peptide
15	H	295	ALA	Peptide
15	H	302	TYR	Sidechain
15	H	314	PHE	Sidechain
15	H	334	ARG	Sidechain
15	H	50	ARG	Sidechain
10	J	83	PHE	Peptide
11	K	50	GLY	Peptide
12	L	280	TYR	Sidechain
12	L	462	PRO	Peptide
12	L	478	ALA	Peptide
12	L	538	TYR	Sidechain
13	M	146	TYR	Sidechain
13	M	292	HIS	Sidechain
13	M	344	TYR	Sidechain
13	M	449	TYR	Sidechain
14	N	169	GLY	Peptide
14	N	172	TYR	Sidechain
14	N	260	TYR	Sidechain
14	N	284	TYR	Sidechain
14	N	346	TYR	Sidechain
14	N	373	TYR	Sidechain
14	N	375	TYR	Sidechain
14	N	422	ALA	Peptide
14	N	85	TYR	Sidechain
14	N	96	HIS	Sidechain

5.2 Too-close contacts [\(i\)](#)

In the following table, the Non-H and H(model) columns list the number of non-hydrogen atoms and hydrogen atoms in the chain respectively. The H(added) column lists the number of hydrogen atoms added and optimized by MolProbity. The Clashes column lists the number of clashes within the asymmetric unit, whereas Symm-Clashes lists symmetry-related clashes.

Mol	Chain	Non-H	H(model)	H(added)	Clashes	Symm-Clashes
1	1	3417	0	3388	34	0
2	2	1406	0	1373	3	0
3	3	5876	0	5914	18	0
4	4	3067	0	3049	7	0
5	5	1607	0	1574	5	0

Continued on next page...

Continued from previous page...

Mol	Chain	Non-H	H(model)	H(added)	Clashes	Symm-Clashes
6	6	1289	0	1298	6	0
7	9	1388	0	1383	2	0
8	7	1031	0	1029	2	0
9	A	910	0	939	1	0
10	J	1183	0	1286	0	0
11	K	703	0	747	0	0
12	L	4604	0	4734	4	0
13	M	3489	0	3606	10	0
14	N	3154	0	3343	3	0
15	H	2838	0	2903	2	0
16	1	8	0	0	0	0
16	3	24	0	0	1	0
16	6	8	0	0	0	0
16	9	16	0	0	1	0
17	1	31	0	19	2	0
18	1	44	0	27	1	0
19	2	4	0	0	0	0
19	3	4	0	0	0	0
All	All	36101	0	36612	92	0

The all-atom clashscore is defined as the number of clashes found per 1000 atoms (including hydrogen atoms). The all-atom clashscore for this structure is 1.

All (92) close contacts within the same asymmetric unit are listed below, sorted by their clash magnitude.

Atom-1	Atom-2	Interatomic distance (Å)	Clash overlap (Å)
1:1:65:ARG:CG	1:1:223:THR:OG1	1.92	1.18
1:1:65:ARG:HB2	1:1:223:THR:OG1	1.49	1.13
1:1:65:ARG:CB	1:1:223:THR:OG1	1.98	1.11
1:1:63:ARG:NH2	1:1:246:SER:HB3	1.93	0.83
1:1:62:LEU:HD11	1:1:65:ARG:NE	1.94	0.82
1:1:62:LEU:HD11	1:1:65:ARG:HE	1.46	0.80
1:1:65:ARG:HG2	1:1:223:THR:OG1	1.80	0.80
1:1:63:ARG:HH21	1:1:246:SER:HA	1.48	0.78
1:1:65:ARG:HG3	1:1:223:THR:OG1	1.85	0.76
1:1:63:ARG:HB3	1:1:63:ARG:CZ	2.17	0.74
1:1:63:ARG:NH2	1:1:246:SER:HA	2.06	0.70
1:1:63:ARG:HA	1:1:71:PRO:HA	1.74	0.70
1:1:63:ARG:HH21	1:1:246:SER:CB	2.05	0.69
1:1:65:ARG:HB2	1:1:223:THR:HG1	1.55	0.69
1:1:63:ARG:NH2	1:1:246:SER:CB	2.59	0.65

Continued on next page...

Continued from previous page...

Atom-1	Atom-2	Interatomic distance (Å)	Clash overlap (Å)
1:1:63:ARG:HH21	1:1:246:SER:CA	2.10	0.64
1:1:63:ARG:NH2	1:1:246:SER:CA	2.63	0.61
17:1:502:FMN:O4'	17:1:502:FMN:O2'	2.10	0.60
1:1:71:PRO:O	1:1:74:LEU:N	2.36	0.58
3:3:474:ARG:HH21	3:3:516:VAL:HG21	1.69	0.57
3:3:538:ALA:HB3	3:3:541:ALA:HB2	1.85	0.57
1:1:62:LEU:CD1	1:1:65:ARG:HH21	2.19	0.56
2:2:163:LEU:HD23	2:2:163:LEU:H	1.70	0.56
6:6:145:GLU:HG2	7:9:31:VAL:HG11	1.88	0.55
4:4:72:HIS:CD2	5:5:152:LEU:HD22	2.42	0.55
3:3:694:LEU:HB3	3:3:762:ALA:HB2	1.89	0.55
1:1:63:ARG:NH2	1:1:245:GLN:O	2.40	0.54
17:1:502:FMN:O4'	17:1:502:FMN:O1P	2.26	0.53
1:1:62:LEU:CD1	1:1:65:ARG:HE	2.18	0.52
1:1:71:PRO:O	1:1:72:THR:C	2.48	0.52
1:1:63:ARG:CG	1:1:64:GLY:N	2.72	0.52
1:1:62:LEU:CD1	1:1:65:ARG:NH2	2.73	0.52
13:M:174:THR:HB	13:M:176:LEU:H	1.75	0.51
13:M:73:LEU:H	13:M:73:LEU:HD23	1.76	0.50
18:1:503:NAI:O2A	18:1:503:NAI:H2B	2.12	0.49
3:3:586:HIS:CD2	3:3:604:ALA:HB2	2.48	0.49
3:3:259:CYS:HB3	16:3:803:SF4:S3	2.53	0.49
4:4:64:THR:HG21	6:6:83:ARG:NE	2.27	0.49
1:1:65:ARG:HD3	1:1:65:ARG:HA	1.58	0.49
5:5:174:LEU:HD13	5:5:180:GLY:HA2	1.94	0.48
3:3:722:THR:HB	3:3:756:GLY:H	1.77	0.48
2:2:28:MET:HB2	2:2:29:PRO:HD3	1.95	0.48
5:5:116:ARG:HE	5:5:135:ILE:HG21	1.78	0.47
1:1:62:LEU:HD12	1:1:65:ARG:HH21	1.79	0.47
1:1:202:LYS:HA	1:1:202:LYS:HD2	1.49	0.47
12:L:325:HIS:HA	12:L:328:PHE:CZ	2.50	0.47
13:M:66:GLY:HA3	13:M:113:ARG:HE	1.80	0.46
7:9:63:CYS:HB2	16:9:201:SF4:S2	2.55	0.46
2:2:33:ARG:HE	2:2:37:GLU:HG3	1.81	0.46
1:1:62:LEU:CD1	1:1:65:ARG:NE	2.73	0.45
1:1:65:ARG:HG2	1:1:223:THR:HG1	1.78	0.45
6:6:39:ALA:HB2	6:6:75:ALA:HB1	1.97	0.45
3:3:719:HIS:CD2	3:3:721:GLU:H	2.35	0.45
1:1:63:ARG:CZ	1:1:63:ARG:CB	2.92	0.44
3:3:287:GLU:O	3:3:288:ILE:HG23	2.17	0.44
3:3:163:HIS:CE1	8:7:55:MET:SD	3.11	0.43

Continued on next page...

Continued from previous page...

Atom-1	Atom-2	Interatomic distance (Å)	Clash overlap (Å)
3:3:371:PHE:CE2	3:3:374:ARG:HA	2.53	0.43
3:3:524:LEU:HD12	3:3:527:ARG:HH21	1.83	0.43
13:M:145:LEU:HD21	14:N:380:LEU:CD1	2.48	0.43
3:3:717:TRP:CE3	3:3:750:ARG:HG3	2.54	0.43
1:1:28:THR:HG22	1:1:30:ASP:H	1.84	0.43
15:H:296:THR:HG22	15:H:296:THR:O	2.19	0.43
3:3:375:THR:HA	3:3:513:GLN:HE22	1.84	0.42
4:4:86:ASP:HB2	4:4:93:HIS:CE1	2.55	0.42
1:1:65:ARG:CG	1:1:223:THR:HG1	2.21	0.42
9:A:105:VAL:HG21	14:N:11:VAL:HG13	2.01	0.42
3:3:459:MET:SD	3:3:465:HIS:CD2	3.13	0.42
3:3:700:LYS:HA	3:3:764:GLY:H	1.84	0.42
1:1:412:GLY:HA2	1:1:415:ARG:HE	1.85	0.42
4:4:170:HIS:CD2	4:4:170:HIS:H	2.38	0.42
5:5:96:GLU:H	5:5:96:GLU:CD	2.22	0.41
13:M:449:TYR:O	13:M:449:TYR:CG	2.72	0.41
5:5:104:VAL:HG23	5:5:111:ALA:HB2	2.03	0.41
6:6:44:ALA:HB3	6:6:83:ARG:H	1.85	0.41
12:L:88:HIS:CE1	12:L:108:PHE:HB3	2.55	0.41
3:3:426:TYR:HB2	3:3:428:HIS:CE1	2.55	0.41
12:L:151:TYR:HB3	12:L:231:ALA:HB1	2.02	0.41
14:N:118:LEU:HD21	14:N:215:VAL:HG21	2.02	0.41
4:4:81:TYR:CZ	6:6:117:MET:SD	3.14	0.41
4:4:87:TYR:CD2	6:6:45:CYS:HB3	2.56	0.41
1:1:64:GLY:HA3	1:1:69:GLY:HA3	2.02	0.41
4:4:33:GLN:O	4:4:34:HIS:CG	2.74	0.41
8:7:46:ARG:HE	8:7:75:ARG:HH22	1.69	0.41
13:M:116:LEU:HD13	13:M:116:LEU:O	2.21	0.41
13:M:318:SER:HA	13:M:321:TYR:CE1	2.55	0.41
13:M:201:PHE:CE2	13:M:240:ALA:HB1	2.57	0.41
13:M:150:LEU:HD23	13:M:150:LEU:HA	1.97	0.40
13:M:208:PHE:O	13:M:211:HIS:CD2	2.74	0.40
3:3:230:CYS:HA	3:3:231:PRO:HD3	1.98	0.40
15:H:96:ALA:HB2	15:H:124:TYR:CE2	2.56	0.40
3:3:603:PRO:HG2	3:3:634:ALA:HA	2.02	0.40
12:L:325:HIS:CE1	12:L:329:LYS:HG3	2.56	0.40

There are no symmetry-related clashes.

5.3 Torsion angles [i](#)

5.3.1 Protein backbone [i](#)

In the following table, the Percentiles column shows the percent Ramachandran outliers of the chain as a percentile score with respect to all PDB entries followed by that with respect to all EM entries.

The Analysed column shows the number of residues for which the backbone conformation was analysed, and the total number of residues.

Mol	Chain	Analysed	Favoured	Allowed	Outliers	Percentiles	
1	1	435/438 (99%)	363 (83%)	58 (13%)	14 (3%)	3	22
2	2	176/181 (97%)	159 (90%)	12 (7%)	5 (3%)	4	25
3	3	748/783 (96%)	628 (84%)	85 (11%)	35 (5%)	2	17
4	4	382/409 (93%)	331 (87%)	37 (10%)	14 (4%)	2	20
5	5	194/207 (94%)	178 (92%)	12 (6%)	4 (2%)	5	31
6	6	164/181 (91%)	131 (80%)	28 (17%)	5 (3%)	3	23
7	9	178/182 (98%)	158 (89%)	11 (6%)	9 (5%)	1	16
8	7	125/129 (97%)	110 (88%)	11 (9%)	4 (3%)	3	22
9	A	115/119 (97%)	101 (88%)	8 (7%)	6 (5%)	1	16
10	J	158/176 (90%)	140 (89%)	15 (10%)	3 (2%)	6	33
11	K	93/95 (98%)	79 (85%)	10 (11%)	4 (4%)	2	18
12	L	603/606 (100%)	537 (89%)	47 (8%)	19 (3%)	3	22
13	M	465/469 (99%)	413 (89%)	40 (9%)	12 (3%)	4	26
14	N	425/427 (100%)	368 (87%)	46 (11%)	11 (3%)	4	26
15	H	351/365 (96%)	301 (86%)	36 (10%)	14 (4%)	2	19
All	All	4612/4767 (97%)	3997 (87%)	456 (10%)	159 (3%)	5	21

All (159) Ramachandran outliers are listed below:

Mol	Chain	Res	Type
3	3	165	ASP
3	3	244	ALA
3	3	288	ILE
3	3	304	ASN
3	3	306	LEU
3	3	530	ALA
3	3	556	ALA
3	3	616	ASN

Continued on next page...

Continued from previous page...

Mol	Chain	Res	Type
3	3	685	PRO
3	3	766	ALA
4	4	169	HIS
7	9	64	PRO
7	9	143	THR
10	J	76	ALA
11	K	81	HIS
12	L	476	ALA
13	M	72	ALA
13	M	417	GLU
14	N	166	PRO
14	N	424	ALA
15	H	217	THR
15	H	218	PRO
1	1	82	ASP
1	1	245	GLN
3	3	74	GLN
3	3	141	GLU
3	3	178	ARG
3	3	232	VAL
3	3	305	ARG
3	3	428	HIS
3	3	487	SER
3	3	557	SER
3	3	634	ALA
3	3	686	LYS
3	3	729	PRO
4	4	38	HIS
4	4	269	ARG
4	4	305	PRO
4	4	318	GLU
6	6	128	ASP
7	9	122	ALA
8	7	90	HIS
9	A	38	ARG
10	J	120	LYS
11	K	94	ARG
12	L	121	ALA
12	L	457	GLY
12	L	484	HIS
12	L	518	PRO
14	N	169	GLY

Continued on next page...

Continued from previous page...

Mol	Chain	Res	Type
15	H	216	ARG
15	H	234	THR
1	1	62	LEU
1	1	63	ARG
1	1	71	PRO
1	1	96	SER
1	1	163	PHE
1	1	179	ALA
2	2	86	LEU
2	2	140	PRO
2	2	144	CYS
3	3	7	ASN
3	3	32	LEU
3	3	44	ALA
3	3	204	GLU
3	3	335	GLU
3	3	553	ALA
3	3	668	LYS
3	3	727	ALA
3	3	755	LYS
4	4	40	VAL
5	5	99	PRO
6	6	17	GLU
6	6	76	ASP
7	9	119	PHE
7	9	165	TYR
8	7	39	ASP
8	7	45	GLU
12	L	97	GLY
12	L	245	MET
12	L	360	PRO
12	L	399	GLY
12	L	462	PRO
13	M	45	GLY
13	M	189	ALA
14	N	192	PHE
14	N	417	GLY
15	H	4	SER
15	H	194	TRP
15	H	233	HIS
15	H	238	SER
15	H	275	PRO

Continued on next page...

Continued from previous page...

Mol	Chain	Res	Type
1	1	258	VAL
1	1	418	LYS
1	1	428	LYS
3	3	381	LEU
4	4	315	HIS
7	9	30	PRO
7	9	65	ALA
9	A	39	ALA
9	A	43	PRO
9	A	49	ASP
11	K	92	GLU
12	L	102	SER
12	L	196	LEU
12	L	438	ALA
14	N	391	PHE
15	H	214	ALA
2	2	175	HIS
3	3	283	PRO
3	3	407	PRO
4	4	211	SER
4	4	258	GLU
4	4	268	GLU
4	4	307	PRO
6	6	130	VAL
6	6	177	LYS
7	9	21	PRO
8	7	5	SER
9	A	85	ALA
12	L	20	PHE
12	L	195	PRO
12	L	440	PRO
13	M	57	PRO
13	M	352	PRO
13	M	387	ALA
13	M	404	ALA
14	N	306	ARG
15	H	49	ASN
1	1	64	GLY
2	2	145	VAL
3	3	194	VAL
5	5	188	SER
9	A	50	PRO

Continued on next page...

Continued from previous page...

Mol	Chain	Res	Type
10	J	28	ALA
13	M	338	THR
14	N	302	ILE
3	3	199	VAL
12	L	435	PRO
14	N	47	PRO
15	H	51	VAL
4	4	52	VAL
7	9	84	GLY
12	L	185	ILE
13	M	223	PRO
13	M	360	ILE
14	N	129	GLY
15	H	44	VAL
15	H	136	ILE
4	4	309	ILE
5	5	77	LEU
12	L	198	ASN
13	M	236	VAL
1	1	97	GLU
1	1	324	GLY
4	4	108	VAL
5	5	150	TYR
11	K	50	GLY
14	N	52	PRO

5.3.2 Protein sidechains [i](#)

In the following table, the Percentiles column shows the percent sidechain outliers of the chain as a percentile score with respect to all PDB entries followed by that with respect to all EM entries.

The Analysed column shows the number of residues for which the sidechain conformation was analysed, and the total number of residues.

Mol	Chain	Analysed	Rotameric	Outliers	Percentiles	
1	1	355/356 (100%)	330 (93%)	25 (7%)	12	33
2	2	150/152 (99%)	146 (97%)	4 (3%)	40	60
3	3	607/628 (97%)	581 (96%)	26 (4%)	25	48
4	4	332/355 (94%)	324 (98%)	8 (2%)	44	64
5	5	167/175 (95%)	162 (97%)	5 (3%)	36	57

Continued on next page...

Continued from previous page...

Mol	Chain	Analysed	Rotameric	Outliers	Percentiles	
6	6	135/149 (91%)	133 (98%)	2 (2%)	60	75
7	9	148/150 (99%)	143 (97%)	5 (3%)	32	54
8	7	104/106 (98%)	101 (97%)	3 (3%)	37	58
9	A	90/92 (98%)	87 (97%)	3 (3%)	33	55
10	J	118/130 (91%)	117 (99%)	1 (1%)	79	85
11	K	71/71 (100%)	69 (97%)	2 (3%)	38	59
12	L	453/454 (100%)	443 (98%)	10 (2%)	47	66
13	M	332/332 (100%)	317 (96%)	15 (4%)	23	46
14	N	302/302 (100%)	297 (98%)	5 (2%)	56	73
15	H	293/300 (98%)	286 (98%)	7 (2%)	44	64
All	All	3657/3752 (98%)	3536 (97%)	121 (3%)	35	55

All (121) residues with a non-rotameric sidechain are listed below:

Mol	Chain	Res	Type
1	1	12	ARG
1	1	30	ASP
1	1	63	ARG
1	1	65	ARG
1	1	71	PRO
1	1	72	THR
1	1	74	LEU
1	1	145	LEU
1	1	184	GLU
1	1	185	GLU
1	1	201	LEU
1	1	202	LYS
1	1	215	PRO
1	1	249	MET
1	1	253	GLN
1	1	303	THR
1	1	333	GLU
1	1	341	MET
1	1	342	TRP
1	1	353	CYS
1	1	359	CYS
1	1	366	PHE
1	1	397	ARG

Continued on next page...

Continued from previous page...

Mol	Chain	Res	Type
1	1	400	CYS
1	1	411	LYS
2	2	5	ASP
2	2	42	ARG
2	2	86	LEU
2	2	178	GLU
3	3	3	ARG
3	3	37	LYS
3	3	42	ILE
3	3	94	ASP
3	3	99	VAL
3	3	118	ASP
3	3	128	CYS
3	3	133	ARG
3	3	168	HIS
3	3	184	CYS
3	3	197	ASP
3	3	259	CYS
3	3	378	PRO
3	3	430	THR
3	3	438	LYS
3	3	474	ARG
3	3	483	ASP
3	3	558	TRP
3	3	567	TYR
3	3	631	ASN
3	3	655	ARG
3	3	657	HIS
3	3	665	LYS
3	3	678	PHE
3	3	720	PRO
3	3	744	GLU
4	4	69	THR
4	4	87	TYR
4	4	153	ARG
4	4	160	PHE
4	4	217	ARG
4	4	262	PHE
4	4	315	HIS
4	4	404	MET
5	5	88	PHE
5	5	96	GLU

Continued on next page...

Continued from previous page...

Mol	Chain	Res	Type
5	5	131	ASP
5	5	156	PRO
5	5	170	PHE
6	6	30	TRP
6	6	50	MET
7	9	78	GLU
7	9	104	CYS
7	9	121	MET
7	9	152	ARG
7	9	163	VAL
8	7	11	GLU
8	7	16	LEU
8	7	45	GLU
9	A	69	ILE
9	A	79	TRP
9	A	108	LEU
10	J	59	TYR
11	K	4	LEU
11	K	9	LEU
12	L	88	HIS
12	L	159	PHE
12	L	169	PHE
12	L	223	MET
12	L	333	PHE
12	L	360	PRO
12	L	393	LEU
12	L	433	HIS
12	L	483	HIS
12	L	516	VAL
13	M	1	MET
13	M	12	PHE
13	M	43	HIS
13	M	54	PRO
13	M	63	TRP
13	M	68	ASP
13	M	73	LEU
13	M	76	LEU
13	M	116	LEU
13	M	178	GLU
13	M	195	LEU
13	M	203	ILE
13	M	211	HIS

Continued on next page...

Continued from previous page...

Mol	Chain	Res	Type
13	M	306	GLU
13	M	430	TRP
14	N	31	LEU
14	N	97	LEU
14	N	105	LEU
14	N	114	LEU
14	N	296	PHE
15	H	147	TYR
15	H	191	GLU
15	H	198	TYR
15	H	228	LEU
15	H	244	PHE
15	H	267	TRP
15	H	315	PRO

Sometimes sidechains can be flipped to improve hydrogen bonding and reduce clashes. All (38) such sidechains are listed below:

Mol	Chain	Res	Type
1	1	35	HIS
1	1	92	ASN
1	1	174	HIS
1	1	220	ASN
1	1	288	GLN
1	1	315	HIS
3	3	7	ASN
3	3	38	HIS
3	3	163	HIS
3	3	167	HIS
3	3	368	HIS
3	3	465	HIS
3	3	639	GLN
3	3	657	HIS
3	3	703	GLN
3	3	719	HIS
4	4	63	HIS
4	4	72	HIS
4	4	93	HIS
4	4	315	HIS
4	4	327	HIS
4	4	377	ASN
9	A	60	HIS
11	K	36	ASN

Continued on next page...

Continued from previous page...

Mol	Chain	Res	Type
11	K	39	ASN
12	L	88	HIS
12	L	341	HIS
12	L	358	HIS
12	L	361	GLN
12	L	433	HIS
12	L	436	HIS
12	L	463	HIS
13	M	211	HIS
13	M	221	ASN
13	M	222	HIS
13	M	349	GLN
14	N	193	HIS
15	H	192	HIS

5.3.3 RNA [i](#)

There are no RNA molecules in this entry.

5.4 Non-standard residues in protein, DNA, RNA chains [i](#)

There are no non-standard protein/DNA/RNA residues in this entry.

5.5 Carbohydrates [i](#)

There are no oligosaccharides in this entry.

5.6 Ligand geometry [i](#)

11 ligands are modelled in this entry.

In the following table, the Counts columns list the number of bonds (or angles) for which Mogul statistics could be retrieved, the number of bonds (or angles) that are observed in the model and the number of bonds (or angles) that are defined in the Chemical Component Dictionary. The Link column lists molecule types, if any, to which the group is linked. The Z score for a bond length (or angle) is the number of standard deviations the observed value is removed from the expected value. A bond length (or angle) with $|Z| > 2$ is considered an outlier worth inspection. RMSZ is the root-mean-square of all Z scores of the bond lengths (or angles).

Mol	Type	Chain	Res	Link	Bond lengths			Bond angles		
					Counts	RMSZ	# Z > 2	Counts	RMSZ	# Z > 2
19	FES	3	804	3	0,4,4	-	-	-		
19	FES	2	201	2	0,4,4	-	-	-		
17	FMN	1	502	-	33,33,33	0.61	0	48,50,50	0.64	1 (2%)
16	SF4	9	201	7	0,12,12	-	-	-		
16	SF4	6	201	6	0,12,12	-	-	-		
16	SF4	3	801	3	0,12,12	-	-	-		
16	SF4	3	802	3	0,12,12	-	-	-		
16	SF4	9	202	7	0,12,12	-	-	-		
18	NAI	1	503	-	42,48,48	0.57	0	47,73,73	0.69	2 (4%)
16	SF4	3	803	3	0,12,12	-	-	-		
16	SF4	1	501	1	0,12,12	-	-	-		

In the following table, the Chirals column lists the number of chiral outliers, the number of chiral centers analysed, the number of these observed in the model and the number defined in the Chemical Component Dictionary. Similar counts are reported in the Torsion and Rings columns. '-' means no outliers of that kind were identified.

Mol	Type	Chain	Res	Link	Chirals	Torsions	Rings
19	FES	3	804	3	-	-	0/1/1/1
19	FES	2	201	2	-	-	0/1/1/1
17	FMN	1	502	-	-	12/18/18/18	0/3/3/3
16	SF4	9	201	7	-	-	0/6/5/5
16	SF4	6	201	6	-	-	0/6/5/5
16	SF4	3	801	3	-	-	0/6/5/5
16	SF4	3	802	3	-	-	0/6/5/5
16	SF4	9	202	7	-	-	0/6/5/5
18	NAI	1	503	-	-	9/25/72/72	0/5/5/5
16	SF4	3	803	3	-	-	0/6/5/5
16	SF4	1	501	1	-	-	0/6/5/5

There are no bond length outliers.

All (3) bond angle outliers are listed below:

Mol	Chain	Res	Type	Atoms	Z	Observed(°)	Ideal(°)
18	1	503	NAI	C3N-C2N-N1N	-2.23	119.91	123.10
18	1	503	NAI	C5A-C6A-N6A	2.20	123.70	120.35
17	1	502	FMN	C4-N3-C2	-2.02	121.91	125.64

There are no chirality outliers.

All (21) torsion outliers are listed below:

Mol	Chain	Res	Type	Atoms
17	1	502	FMN	N10-C1'-C2'-C3'
17	1	502	FMN	C1'-C2'-C3'-O3'
17	1	502	FMN	C1'-C2'-C3'-C4'
18	1	503	NAI	O4B-C4B-C5B-O5B
17	1	502	FMN	O2'-C2'-C3'-O3'
18	1	503	NAI	C3B-C4B-C5B-O5B
17	1	502	FMN	O2'-C2'-C3'-C4'
17	1	502	FMN	C2'-C3'-C4'-O4'
18	1	503	NAI	C5B-O5B-PA-O3
17	1	502	FMN	C4'-C5'-O5'-P
18	1	503	NAI	O4D-C1D-N1N-C2N
17	1	502	FMN	C2'-C3'-C4'-C5'
18	1	503	NAI	PN-O3-PA-O1A
18	1	503	NAI	PN-O3-PA-O2A
18	1	503	NAI	C4B-C5B-O5B-PA
18	1	503	NAI	C2D-C1D-N1N-C2N
17	1	502	FMN	O3'-C3'-C4'-O4'
17	1	502	FMN	O4'-C4'-C5'-O5'
17	1	502	FMN	O3'-C3'-C4'-C5'
18	1	503	NAI	C5B-O5B-PA-O1A
17	1	502	FMN	N10-C1'-C2'-O2'

There are no ring outliers.

4 monomers are involved in 5 short contacts:

Mol	Chain	Res	Type	Clashes	Symm-Clashes
17	1	502	FMN	2	0
16	9	201	SF4	1	0
18	1	503	NAI	1	0
16	3	803	SF4	1	0

The following is a two-dimensional graphical depiction of Mogul quality analysis of bond lengths, bond angles, torsion angles, and ring geometry for all instances of the Ligand of Interest. In addition, ligands with molecular weight > 250 and outliers as shown on the validation Tables will also be included. For torsion angles, if less than 5% of the Mogul distribution of torsion angles is within 10 degrees of the torsion angle in question, then that torsion angle is considered an outlier. Any bond that is central to one or more torsion angles identified as an outlier by Mogul will be highlighted in the graph. For rings, the root-mean-square deviation (RMSD) between the ring in question and similar rings identified by Mogul is calculated over all ring torsion angles. If the average RMSD is greater than 60 degrees and the minimal RMSD between the ring in question and any Mogul-identified rings is also greater than 60 degrees, then that ring is considered an outlier. The outliers are highlighted in purple. The color gray indicates Mogul did not find sufficient equivalents in the CSD to analyse the geometry.

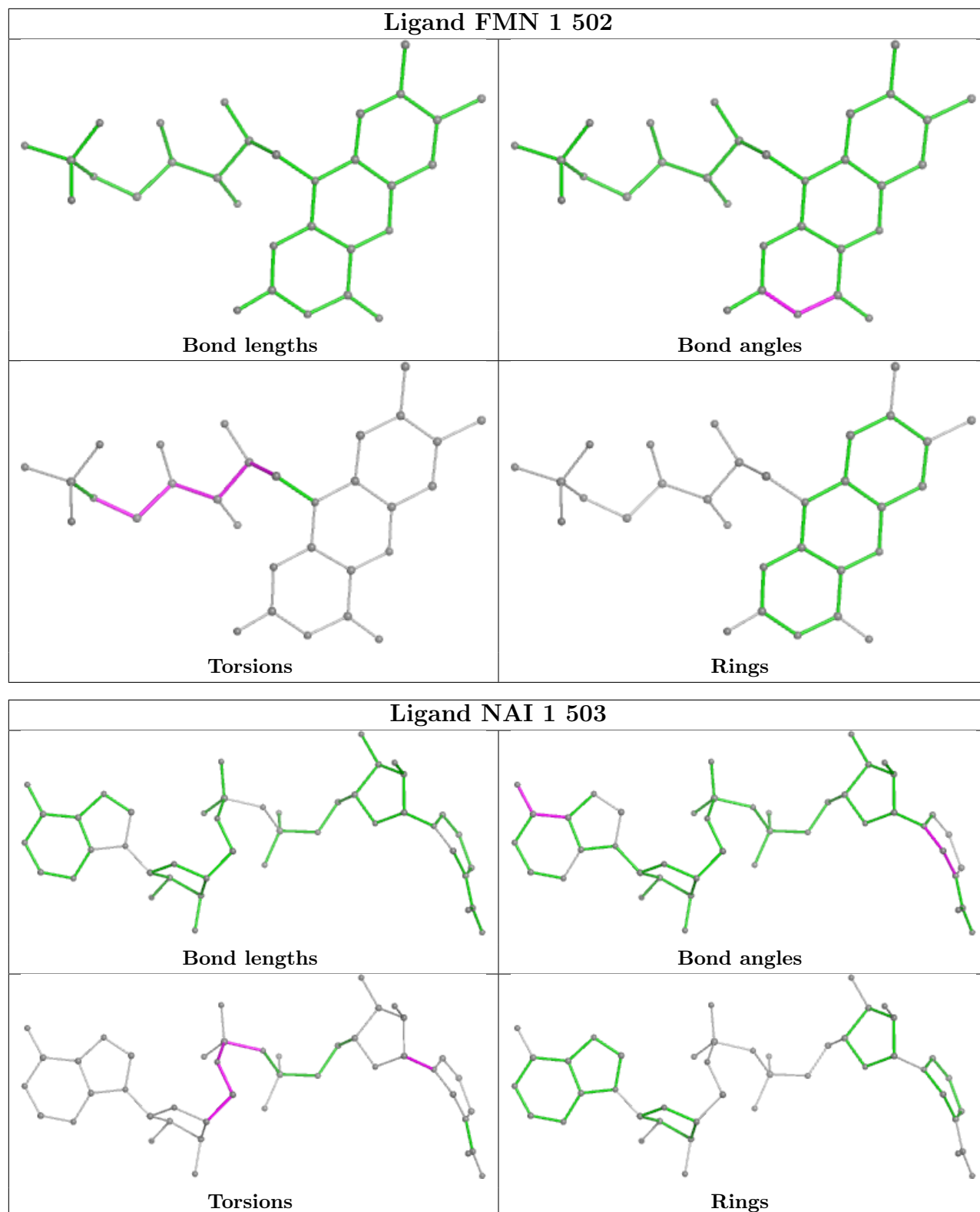

5.7 Other polymers ⓘ

There are no such residues in this entry.

5.8 Polymer linkage issues

There are no chain breaks in this entry.

6 Map visualisation [i](#)

This section contains visualisations of the EMDB entry EMD-11231. These allow visual inspection of the internal detail of the map and identification of artifacts.

No raw map or half-maps were deposited for this entry and therefore no images, graphs, etc. pertaining to the raw map can be shown.

6.1 Orthogonal projections [i](#)

6.1.1 Primary map

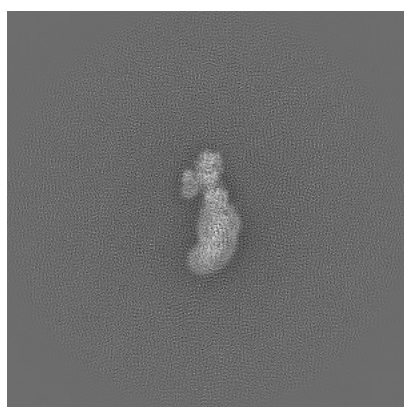

X

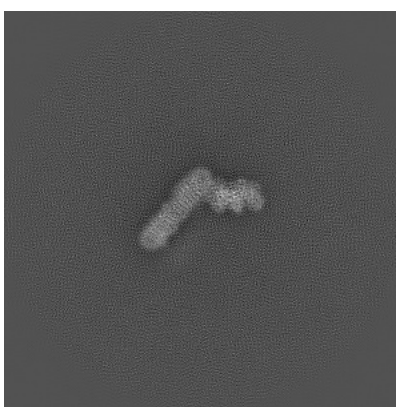

Y

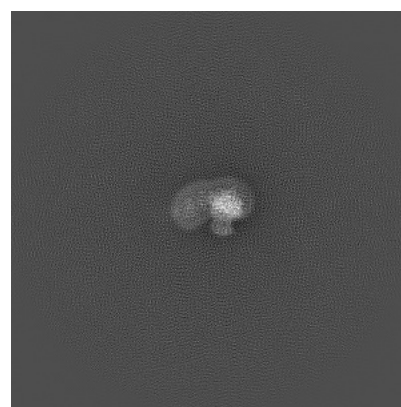

Z

The images above show the map projected in three orthogonal directions.

6.2 Central slices [i](#)

6.2.1 Primary map

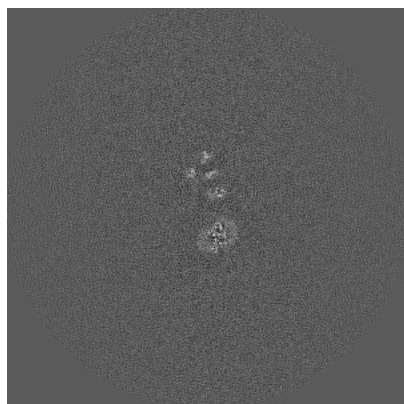

X Index: 256



Y Index: 256

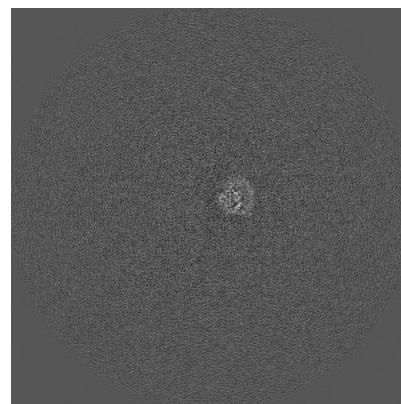

Z Index: 256

The images above show central slices of the map in three orthogonal directions.

6.3 Largest variance slices [i](#)

6.3.1 Primary map



X Index: 279

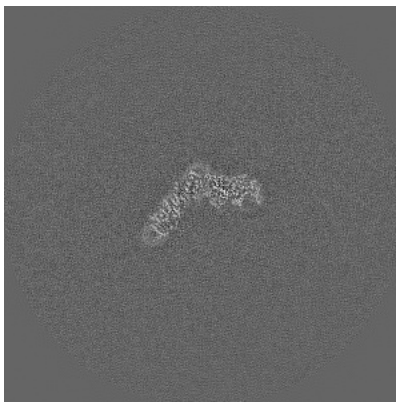

Y Index: 264



Z Index: 279

The images above show the largest variance slices of the map in three orthogonal directions.

6.4 Orthogonal standard-deviation projections (False-color) [i](#)

6.4.1 Primary map

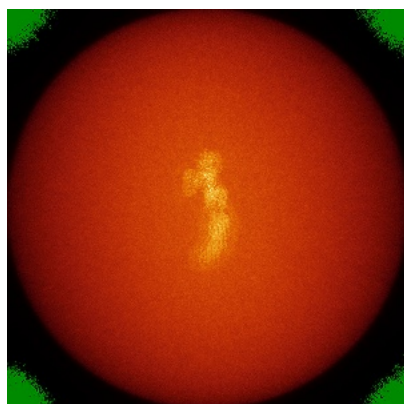

X

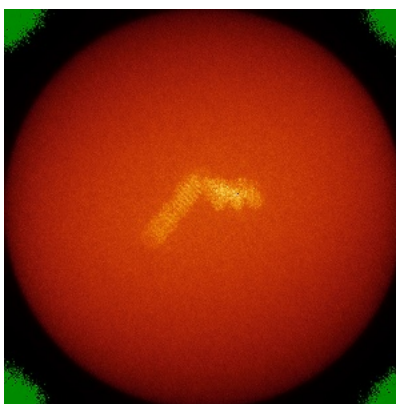

Y

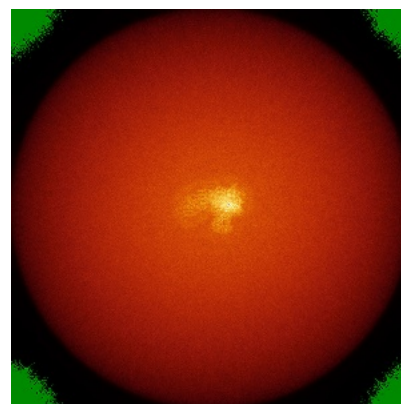

Z

The images above show the map standard deviation projections with false color in three orthogonal directions. Minimum values are shown in green, max in blue, and dark to light orange shades represent small to large values respectively.

6.5 Orthogonal surface views [i](#)

6.5.1 Primary map

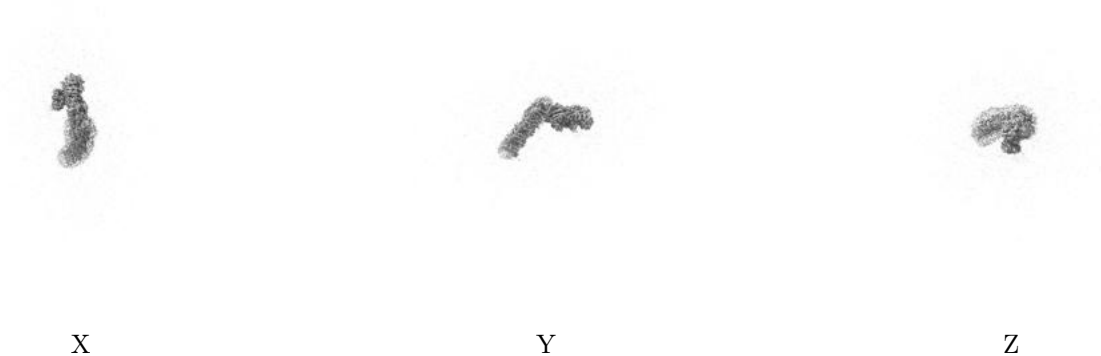

The images above show the 3D surface view of the map at the recommended contour level 0.24. These images, in conjunction with the slice images, may facilitate assessment of whether an appropriate contour level has been provided.

6.6 Mask visualisation [i](#)

This section was not generated. No masks/segmentation were deposited.

7 Map analysis [i](#)

This section contains the results of statistical analysis of the map.

7.1 Map-value distribution [i](#)

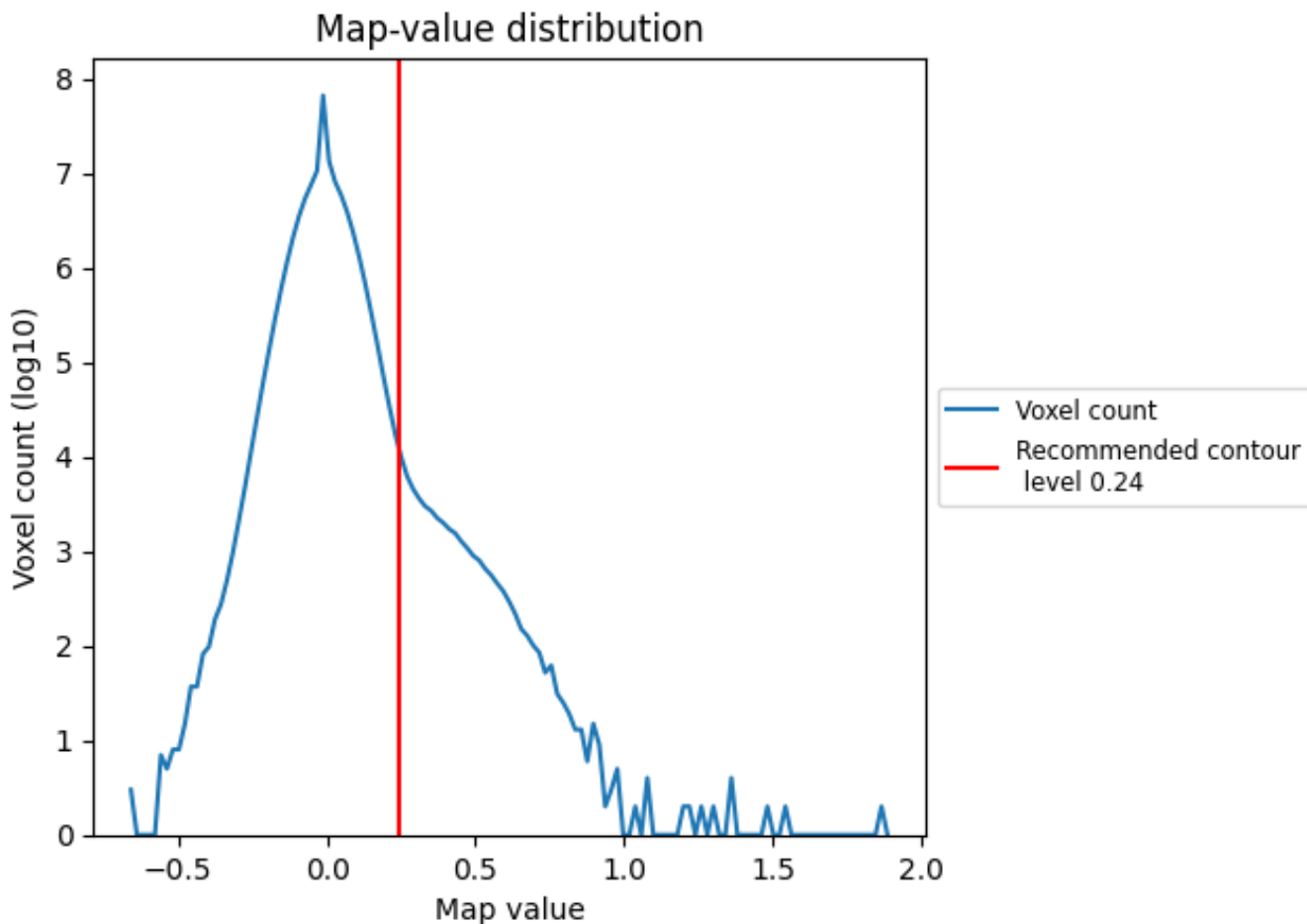

The map-value distribution is plotted in 128 intervals along the x-axis. The y-axis is logarithmic. A spike in this graph at zero usually indicates that the volume has been masked.

7.2 Volume estimate [i](#)

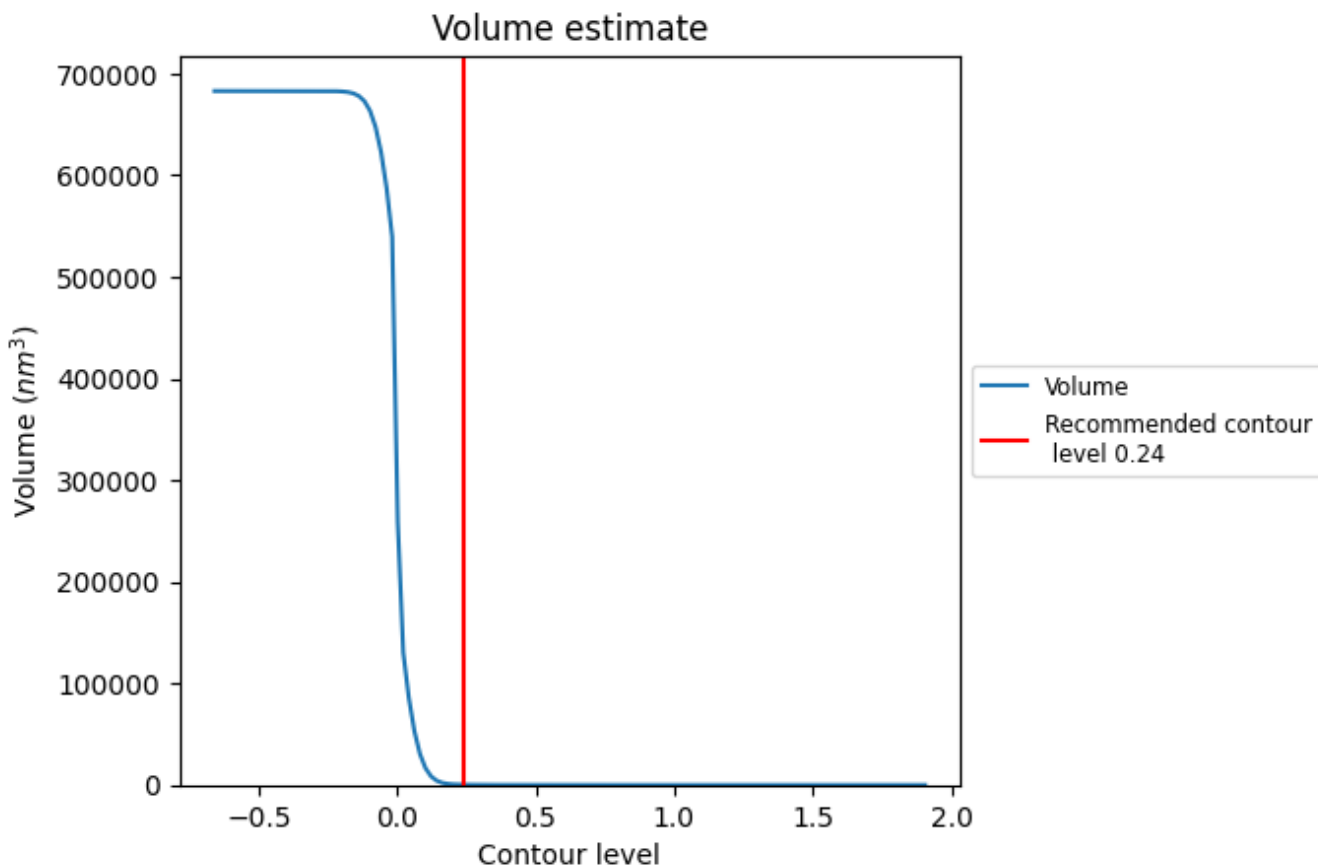

The volume at the recommended contour level is 269 nm³; this corresponds to an approximate mass of 243 kDa.

The volume estimate graph shows how the enclosed volume varies with the contour level. The recommended contour level is shown as a vertical line and the intersection between the line and the curve gives the volume of the enclosed surface at the given level.

7.3 Rotationally averaged power spectrum [\(i\)](#)

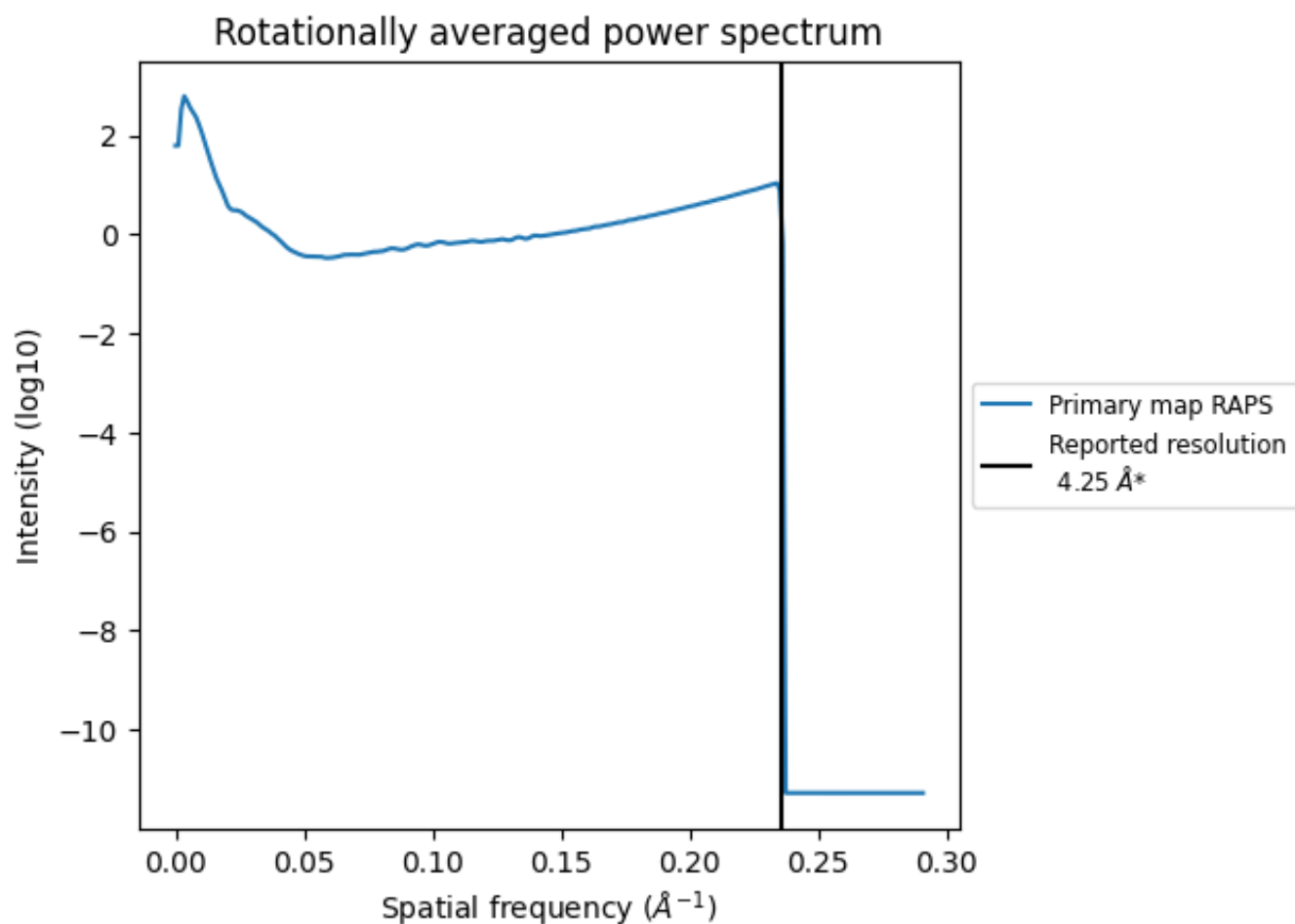

*Reported resolution corresponds to spatial frequency of 0.235\AA^{-1}

8 Fourier-Shell correlation [i](#)

Fourier-Shell Correlation (FSC) is the most commonly used method to estimate the resolution of single-particle and subtomogram-averaged maps. The shape of the curve depends on the imposed symmetry, mask and whether or not the two 3D reconstructions used were processed from a common reference. The reported resolution is shown as a black line. A curve is displayed for the half-bit criterion in addition to lines showing the 0.143 gold standard cut-off and 0.5 cut-off.

8.1 FSC [i](#)

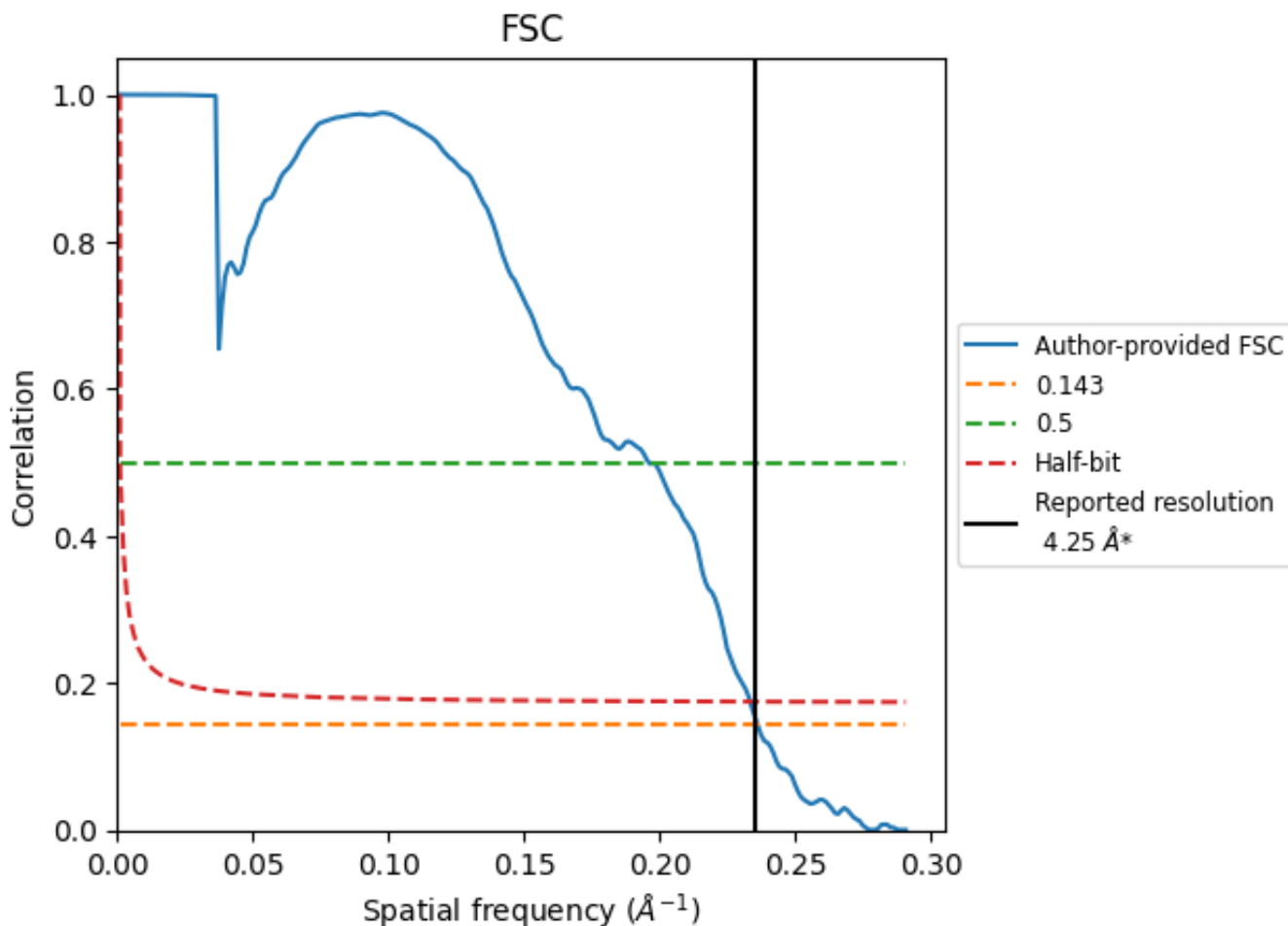

*Reported resolution corresponds to spatial frequency of 0.235 Å⁻¹

8.2 Resolution estimates [i](#)

Resolution estimate (Å)	Estimation criterion (FSC cut-off)		
	0.143	0.5	Half-bit
Reported by author	4.25	-	-
Author-provided FSC curve	4.24	5.10	4.29
Unmasked-calculated*	-	-	-

*Resolution estimate based on FSC curve calculated by comparison of deposited half-maps.

9 Map-model fit [i](#)

This section contains information regarding the fit between EMDB map EMD-11231 and PDB model 6ZIIY. Per-residue inclusion information can be found in section 3 on page 9.

9.1 Map-model overlay [i](#)

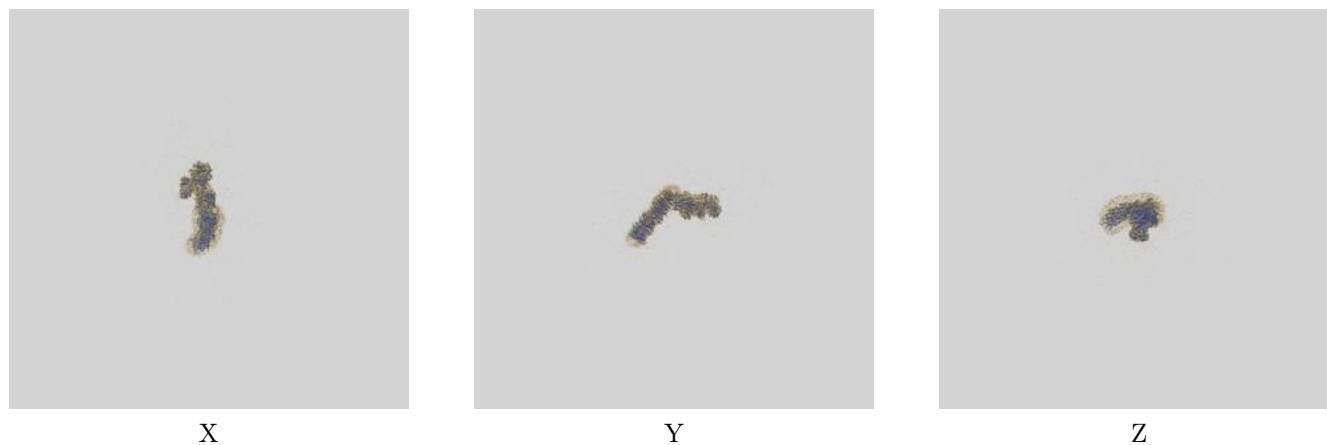

The images above show the 3D surface view of the map at the recommended contour level 0.24 at 50% transparency in yellow overlaid with a ribbon representation of the model coloured in blue. These images allow for the visual assessment of the quality of fit between the atomic model and the map.

9.2 Q-score mapped to coordinate model [i](#)

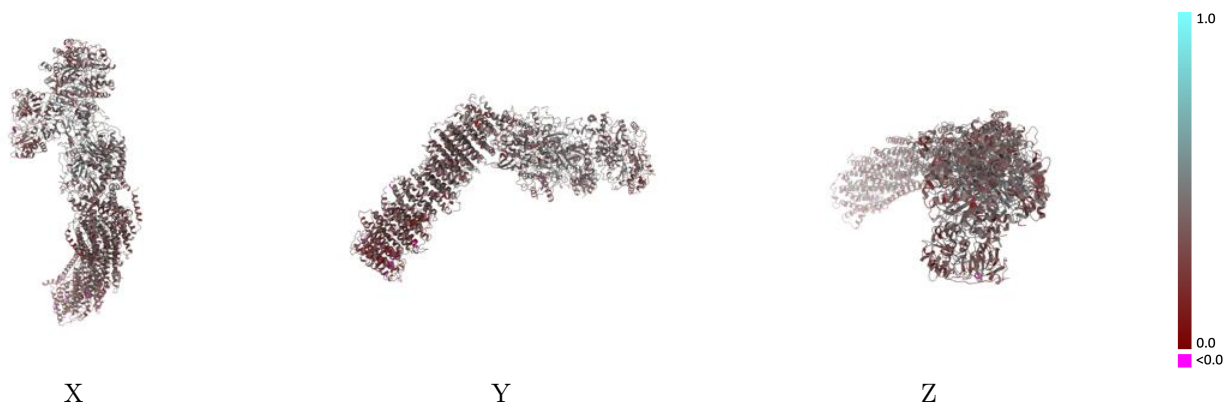

The images above show the model with each residue coloured according to its Q-score. This shows their resolvability in the map with higher Q-score values reflecting better resolvability. Please note: Q-score is calculating the resolvability of atoms, and thus high values are only expected at resolutions at which atoms can be resolved. Low Q-score values may therefore be expected for many entries.

9.3 Atom inclusion mapped to coordinate model [i](#)

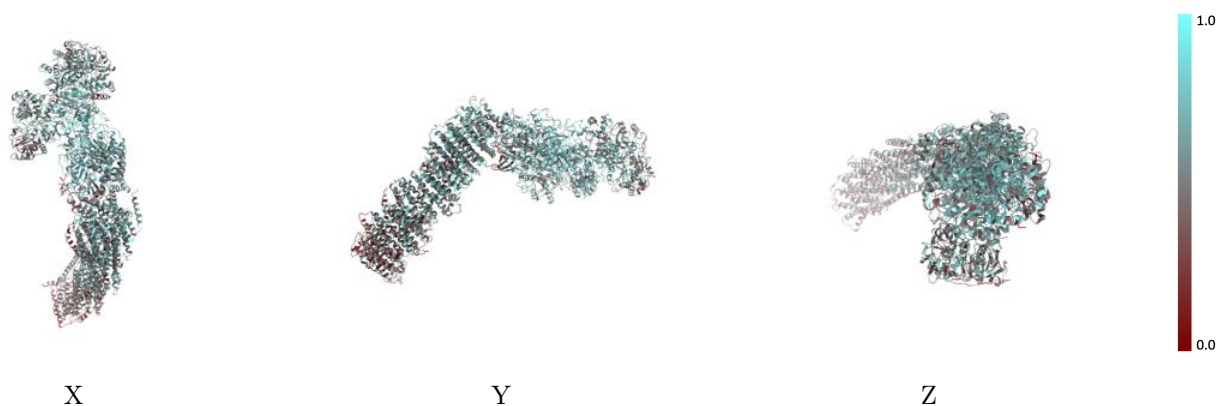

The images above show the model with each residue coloured according to its atom inclusion. This shows to what extent they are inside the map at the recommended contour level (0.24).



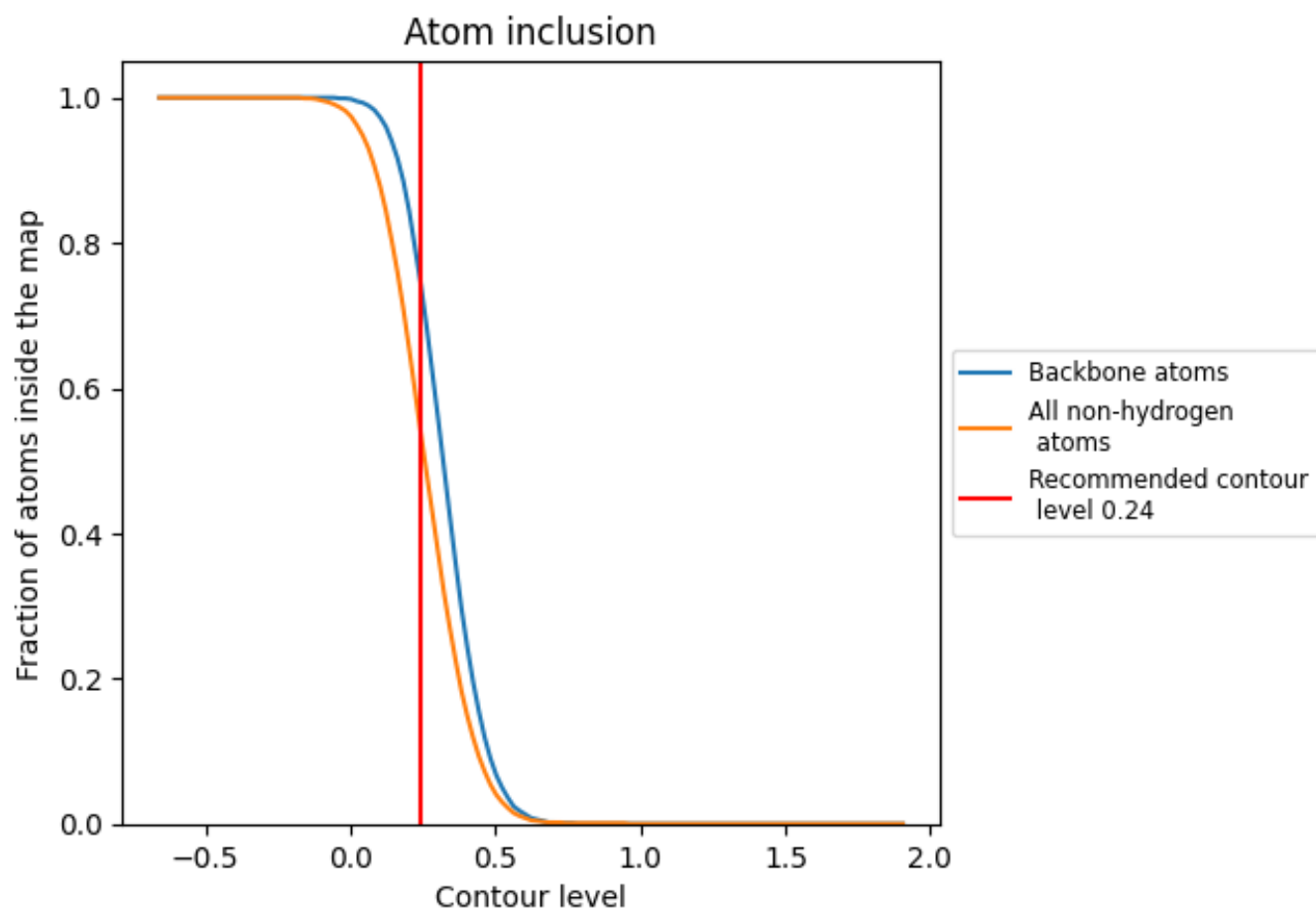





























9.4 Atom inclusion [i](#)



At the recommended contour level, 75% of all backbone atoms, 55% of all non-hydrogen atoms, are inside the map.

9.5 Map-model fit summary

The table lists the average atom inclusion at the recommended contour level (0.24) and Q-score for the entire model and for each chain.

Chain	Atom inclusion	Q-score
All	 0.5460	 0.3790
1	 0.5700	 0.3880
2	 0.5660	 0.3920
3	 0.5750	 0.3960
4	 0.6270	 0.4300
5	 0.6140	 0.4160
6	 0.6120	 0.4310
7	 0.5680	 0.4040
9	 0.6970	 0.4450
A	 0.4690	 0.3680
H	 0.5710	 0.3860
J	 0.5290	 0.3710
K	 0.5380	 0.3860
L	 0.3790	 0.2890
M	 0.4990	 0.3450
N	 0.5480	 0.3750

