



Full wwPDB X-ray Structure Validation Report ⓘ

Mar 3, 2024 – 09:21 AM EST

PDB ID : 6BRY
Title : Tubulin-RB3_SLD-TTL in complex with heterocyclic pyrimidine compound 6a
Authors : Kumar, G.; Wang, Y.; Li, W.; White, S.W.
Deposited on : 2017-12-01
Resolution : 2.70 Å(reported)

This is a Full wwPDB X-ray Structure Validation Report for a publicly released PDB entry.

We welcome your comments at validation@mail.wwpdb.org

A user guide is available at

<https://www.wwpdb.org/validation/2017/XrayValidationReportHelp>

with specific help available everywhere you see the ⓘ symbol.

The types of validation reports are described at

<http://www.wwpdb.org/validation/2017/FAQs#types>.

The following versions of software and data (see [references ⓘ](#)) were used in the production of this report:

MolProbity : 4.02b-467
Mogul : 1.8.5 (274361), CSD as541be (2020)
Xtriage (Phenix) : 1.13
EDS : 2.36
buster-report : 1.1.7 (2018)
Percentile statistics : 20191225.v01 (using entries in the PDB archive December 25th 2019)
Refmac : 5.8.0158
CCP4 : 7.0.044 (Gargrove)
Ideal geometry (proteins) : Engh & Huber (2001)
Ideal geometry (DNA, RNA) : Parkinson et al. (1996)
Validation Pipeline (wwPDB-VP) : 2.36

1 Overall quality at a glance i

The following experimental techniques were used to determine the structure:

X-RAY DIFFRACTION

The reported resolution of this entry is 2.70 Å.

Percentile scores (ranging between 0-100) for global validation metrics of the entry are shown in the following graphic. The table shows the number of entries on which the scores are based.

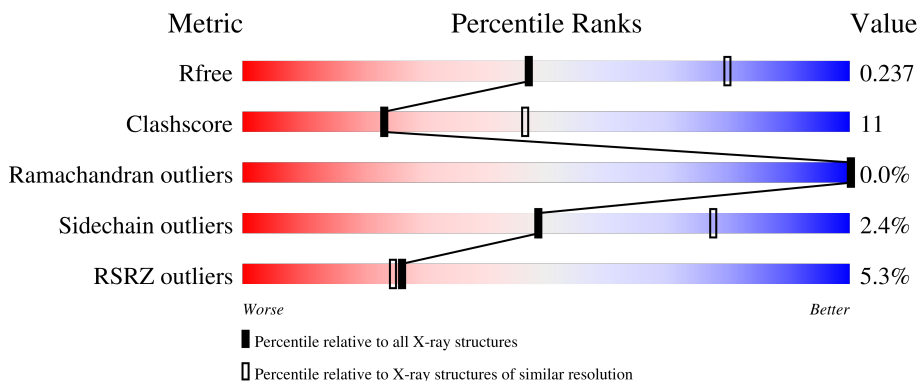

Metric	Whole archive (#Entries)	Similar resolution (#Entries, resolution range(Å))
R_{free}	130704	2808 (2.70-2.70)
Clashscore	141614	3122 (2.70-2.70)
Ramachandran outliers	138981	3069 (2.70-2.70)
Sidechain outliers	138945	3069 (2.70-2.70)
RSRZ outliers	127900	2737 (2.70-2.70)

The table below summarises the geometric issues observed across the polymeric chains and their fit to the electron density. The red, orange, yellow and green segments of the lower bar indicate the fraction of residues that contain outliers for ≥ 3 , 2, 1 and 0 types of geometric quality criteria respectively. A grey segment represents the fraction of residues that are not modelled. The numeric value for each fraction is indicated below the corresponding segment, with a dot representing fractions $\leq 5\%$. The upper red bar (where present) indicates the fraction of residues that have poor fit to the electron density. The numeric value is given above the bar.

Mol	Chain	Length	Quality of chain
1	A	450	
1	C	450	
2	B	445	
2	D	445	
3	E	143	

Continued on next page...

Continued from previous page...

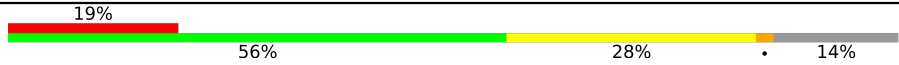
Mol	Chain	Length	Quality of chain										
4	F	384	 <p>A horizontal bar chart showing the quality distribution of chain F. The bar is divided into four segments: red (19%), green (56%), yellow (28%), and grey (14%).</p> <table border="1"><thead><tr><th>Quality Category</th><th>Percentage</th></tr></thead><tbody><tr><td>Red</td><td>19%</td></tr><tr><td>Green</td><td>56%</td></tr><tr><td>Yellow</td><td>28%</td></tr><tr><td>Grey</td><td>14%</td></tr></tbody></table>	Quality Category	Percentage	Red	19%	Green	56%	Yellow	28%	Grey	14%
Quality Category	Percentage												
Red	19%												
Green	56%												
Yellow	28%												
Grey	14%												

2 Entry composition [i](#)

There are 12 unique types of molecules in this entry. The entry contains 17762 atoms, of which 14 are hydrogens and 0 are deuteriums.

In the tables below, the ZeroOcc column contains the number of atoms modelled with zero occupancy, the AltConf column contains the number of residues with at least one atom in alternate conformation and the Trace column contains the number of residues modelled with at most 2 atoms.

- Molecule 1 is a protein called Tubulin alpha-1B chain.

Mol	Chain	Residues	Atoms					ZeroOcc	AltConf	Trace
			Total	C	N	O	S			
1	A	437	Total	C	N	O	S	0	0	0
			3416	2163	581	650	22			
1	C	440	Total	C	N	O	S	0	0	0
			3437	2175	584	656	22			

- Molecule 2 is a protein called Tubulin beta-2B chain.

Mol	Chain	Residues	Atoms					ZeroOcc	AltConf	Trace
			Total	C	N	O	S			
2	B	428	Total	C	N	O	S	0	0	0
			3369	2115	577	650	27			
2	D	421	Total	C	N	O	S	0	0	0
			3309	2080	562	640	27			

- Molecule 3 is a protein called Stathmin-4.

Mol	Chain	Residues	Atoms					ZeroOcc	AltConf	Trace
			Total	C	N	O	S			
3	E	121	Total	C	N	O	S	0	0	0
			1000	617	181	197	5			

There are 2 discrepancies between the modelled and reference sequences:

Chain	Residue	Modelled	Actual	Comment	Reference
E	3	MET	-	expression tag	UNP Q9H169
E	4	ALA	-	expression tag	UNP Q9H169

- Molecule 4 is a protein called Tubulin tyrosine ligase.

Mol	Chain	Residues	Atoms					ZeroOcc	AltConf	Trace
			Total	C	N	O	S			
4	F	332	Total	C	N	O	S	0	0	0
			2727	1752	468	493	14			

There are 6 discrepancies between the modelled and reference sequences:

Chain	Residue	Modelled	Actual	Comment	Reference
F	379	HIS	-	expression tag	UNP E1BQ43
F	380	HIS	-	expression tag	UNP E1BQ43
F	381	HIS	-	expression tag	UNP E1BQ43
F	382	HIS	-	expression tag	UNP E1BQ43
F	383	HIS	-	expression tag	UNP E1BQ43
F	384	HIS	-	expression tag	UNP E1BQ43

- Molecule 5 is GUANOSINE-5'-TRIPHOSPHATE (three-letter code: GTP) (formula: $C_{10}H_{16}N_5O_{14}P_3$).



Mol	Chain	Residues	Atoms					ZeroOcc	AltConf
			Total	C	N	O	P		
5	A	1	Total	C	N	O	P	0	0
			32	10	5	14	3		
5	C	1	Total	C	N	O	P	0	0
			32	10	5	14	3		

- Molecule 6 is MAGNESIUM ION (three-letter code: MG) (formula: Mg).

Mol	Chain	Residues	Atoms		ZeroOcc	AltConf
			Total	Mg		
6	A	1	Total	Mg	0	0
			1	1		
6	B	1	Total	Mg	0	0
			1	1		
6	C	1	Total	Mg	0	0
			1	1		
6	F	1	Total	Mg	0	0
			1	1		

- Molecule 7 is CALCIUM ION (three-letter code: CA) (formula: Ca).

Mol	Chain	Residues	Atoms		ZeroOcc	AltConf
7	A	1	Total	Ca	0	0
			1	1		
7	C	1	Total	Ca	0	0
			1	1		

- Molecule 8 is GUANOSINE-5'-DIPHOSPHATE (three-letter code: GDP) (formula: C₁₀H₁₅N₅O₁₁P₂).

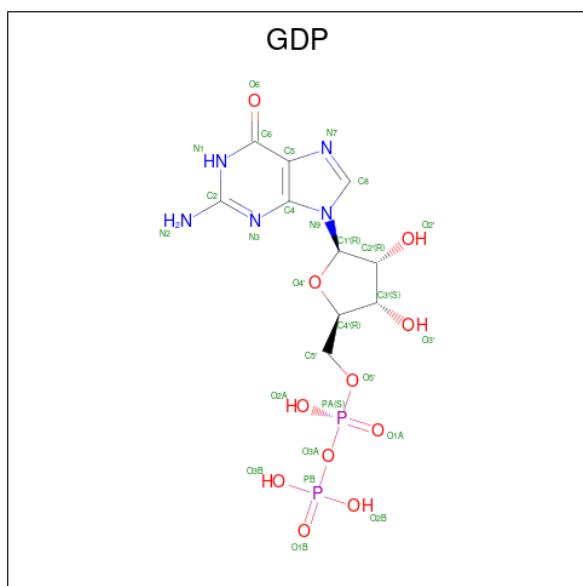

Mol	Chain	Residues	Atoms				ZeroOcc	AltConf	
8	B	1	Total	C	N	O	P	0	0
			28	10	5	11	2		
8	D	1	Total	C	N	O	P	0	0
			28	10	5	11	2		

- Molecule 9 is 2-(N-MORPHOLINO)-ETHANESULFONIC ACID (three-letter code: MES) (formula: C₆H₁₃NO₄S).

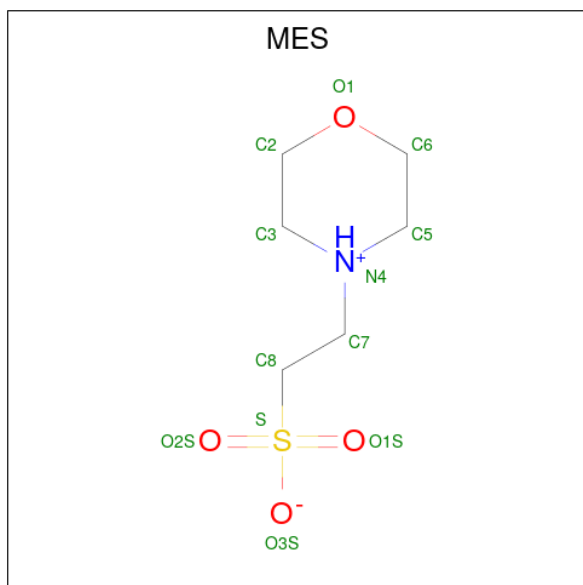

Mol	Chain	Residues	Atoms					ZeroOcc	AltConf	
			Total	C	N	O	S			
9	B	1	Total	12	6	1	4	1	0	0
9	B	1	Total	12	6	1	4	1	0	0
9	C	1	Total	12	6	1	4	1	0	0

- Molecule 10 is 1-(2-chlorofuro[3,2-d]pyrimidin-4-yl)-6-methoxy-1,2,3,4-tetrahydroquinoline (three-letter code: GK9) (formula: C₁₆H₁₄ClN₃O₂) (labeled as "Ligand of Interest" by depositor).

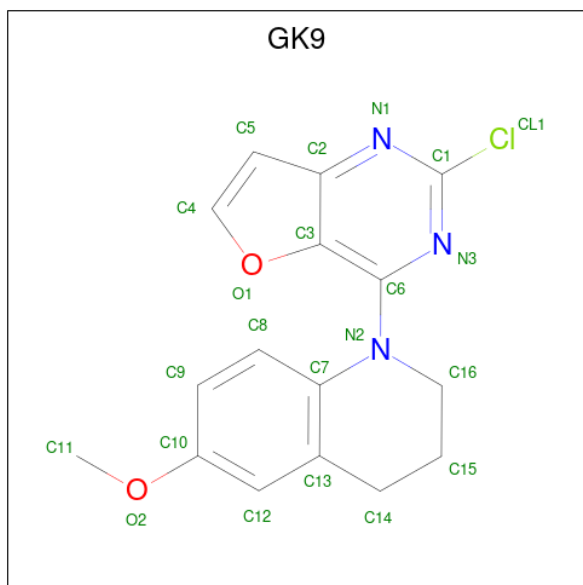

Mol	Chain	Residues	Atoms				ZeroOcc	AltConf	
10	B	1	Total	C	Cl	N	O	0	0
			22	16	1	3	2		
10	D	1	Total	C	Cl	N	O	0	0
			22	16	1	3	2		

- Molecule 11 is PHOSPHOMETHYLPHOSPHONIC ACID ADENYLATE ESTER (three-letter code: ACP) (formula: C₁₁H₁₈N₅O₁₂P₃).

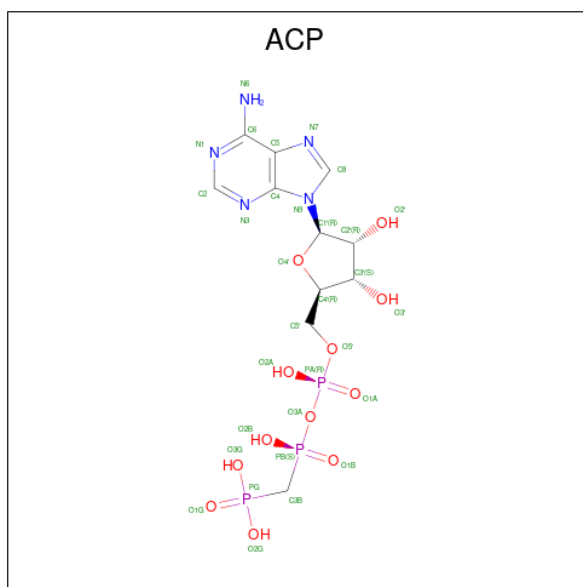

Mol	Chain	Residues	Atoms					ZeroOcc	AltConf	
11	F	1	Total	C	H	N	O	P	0	0
			45	11	14	5	12	3		

- Molecule 12 is water.

Mol	Chain	Residues	Atoms		ZeroOcc	AltConf
12	A	55	Total	O	0	0
			55	55		
12	B	52	Total	O	0	0
			52	52		
12	C	109	Total	O	0	0
			109	109		
12	D	12	Total	O	0	0
			12	12		
12	E	5	Total	O	0	0
			5	5		
12	F	20	Total	O	0	0
			20	20		

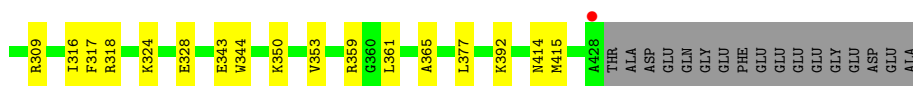

• Molecule 2: Tubulin beta-2B chain

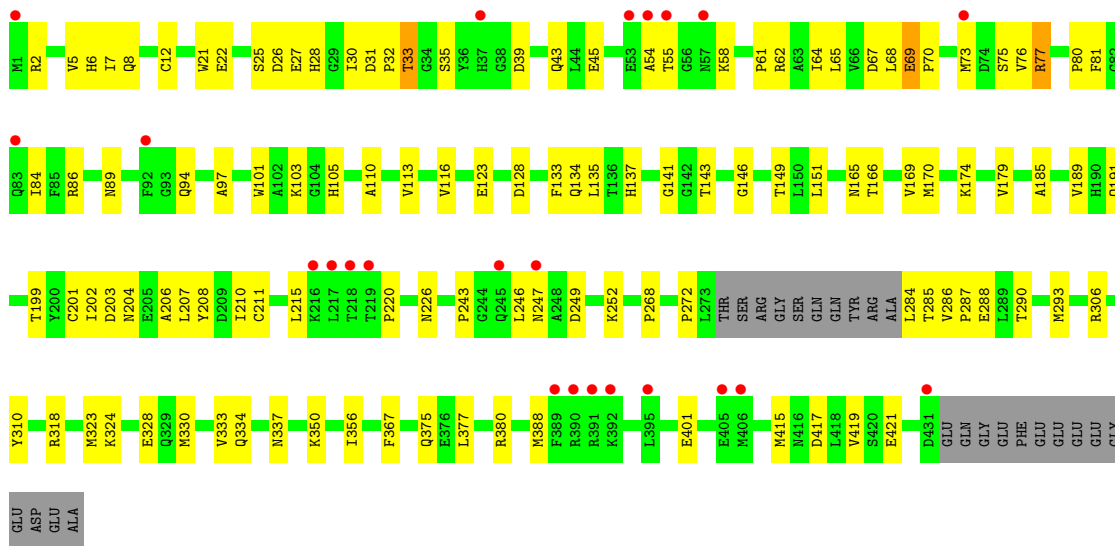

• Molecule 3: Stathmin-4

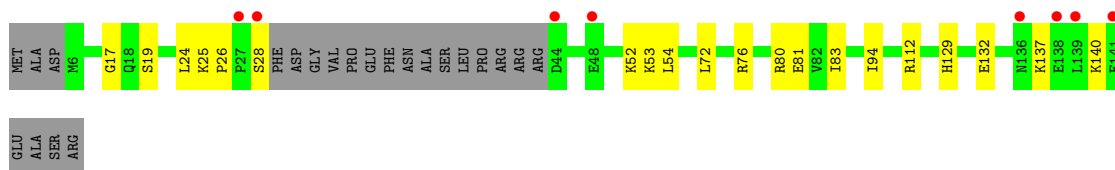

• Molecule 4: Tubulin tyrosine ligase

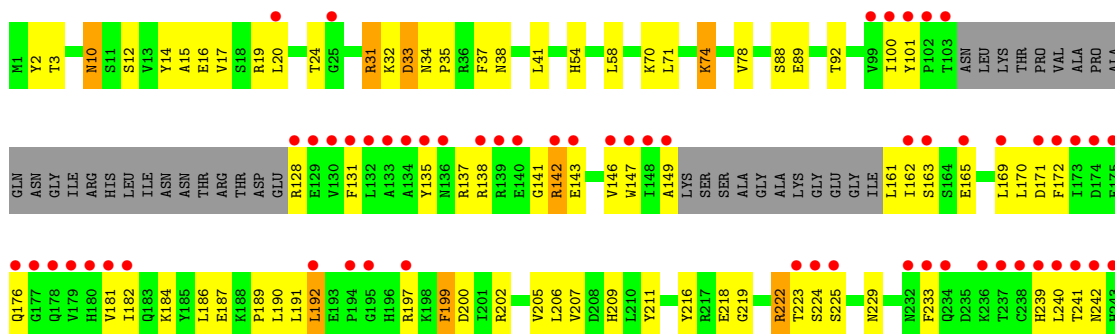

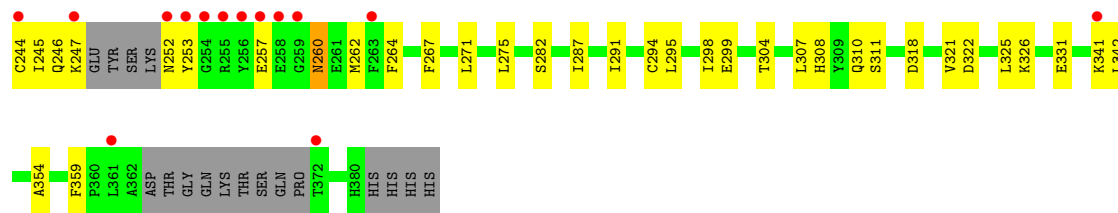

4 Data and refinement statistics

Property	Value	Source
Space group	P 21 21 21	Depositor
Cell constants a, b, c, α , β , γ	105.09Å 157.77Å 181.46Å 90.00° 90.00° 90.00°	Depositor
Resolution (Å)	49.75 – 2.70 49.75 – 2.69	Depositor EDS
% Data completeness (in resolution range)	96.9 (49.75-2.70) 97.0 (49.75-2.69)	Depositor EDS
R_{merge}	0.14	Depositor
R_{sym}	(Not available)	Depositor
$\langle I/\sigma(I) \rangle$ ¹	2.23 (at 2.69Å)	Xtrriage
Refinement program	PHENIX dev_2947	Depositor
R, R_{free}	0.191 , 0.236 0.191 , 0.237	Depositor DCC
R_{free} test set	4782 reflections (5.87%)	wwPDB-VP
Wilson B-factor (Å ²)	41.6	Xtrriage
Anisotropy	0.041	Xtrriage
Bulk solvent k_{sol} (e/Å ³), B_{sol} (Å ²)	0.32 , 43.2	EDS
L-test for twinning ²	$\langle L \rangle = 0.50$, $\langle L^2 \rangle = 0.34$	Xtrriage
Estimated twinning fraction	No twinning to report.	Xtrriage
F_o, F_c correlation	0.93	EDS
Total number of atoms	17762	wwPDB-VP
Average B, all atoms (Å ²)	49.0	wwPDB-VP

Xtrriage's analysis on translational NCS is as follows: *The largest off-origin peak in the Patterson function is 2.70% of the height of the origin peak. No significant pseudotranslation is detected.*

¹Intensities estimated from amplitudes.

²Theoretical values of $\langle |L| \rangle$, $\langle L^2 \rangle$ for acentric reflections are 0.5, 0.333 respectively for untwinned datasets, and 0.375, 0.2 for perfectly twinned datasets.

5 Model quality [i](#)

5.1 Standard geometry [i](#)

Bond lengths and bond angles in the following residue types are not validated in this section: GDP, MG, MES, GTP, CA, ACP, GK9

The Z score for a bond length (or angle) is the number of standard deviations the observed value is removed from the expected value. A bond length (or angle) with $|Z| > 5$ is considered an outlier worth inspection. RMSZ is the root-mean-square of all Z scores of the bond lengths (or angles).

Mol	Chain	Bond lengths		Bond angles	
		RMSZ	# Z >5	RMSZ	# Z >5
1	A	0.41	0/3494	0.59	0/4743
1	C	0.44	0/3515	0.63	0/4772
2	B	0.40	0/3444	0.59	0/4664
2	D	0.38	0/3382	0.55	0/4581
3	E	0.40	0/1008	0.49	0/1337
4	F	0.35	0/2789	0.51	0/3768
All	All	0.40	0/17632	0.57	0/23865

There are no bond length outliers.

There are no bond angle outliers.

There are no chirality outliers.

There are no planarity outliers.

5.2 Too-close contacts [i](#)

In the following table, the Non-H and H(model) columns list the number of non-hydrogen atoms and hydrogen atoms in the chain respectively. The H(added) column lists the number of hydrogen atoms added and optimized by MolProbity. The Clashes column lists the number of clashes within the asymmetric unit, whereas Symm-Clashes lists symmetry-related clashes.

Mol	Chain	Non-H	H(model)	H(added)	Clashes	Symm-Clashes
1	A	3416	0	3331	57	0
1	C	3437	0	3348	62	0
2	B	3369	0	3250	61	0
2	D	3309	0	3189	101	0
3	E	1000	0	1018	15	0
4	F	2727	0	2699	110	0
5	A	32	0	12	0	0

Continued on next page...

Continued from previous page...

Mol	Chain	Non-H	H(model)	H(added)	Clashes	Symm-Clashes
5	C	32	0	12	0	0
6	A	1	0	0	0	0
6	B	1	0	0	0	0
6	C	1	0	0	0	0
6	F	1	0	0	0	0
7	A	1	0	0	0	0
7	C	1	0	0	0	0
8	B	28	0	12	1	0
8	D	28	0	12	4	0
9	B	24	0	24	6	0
9	C	12	0	12	3	0
10	B	22	0	0	0	0
10	D	22	0	0	0	0
11	F	31	14	13	6	0
12	A	55	0	0	1	0
12	B	52	0	0	0	0
12	C	109	0	0	1	0
12	D	12	0	0	0	0
12	E	5	0	0	1	0
12	F	20	0	0	0	0
All	All	17748	14	16932	388	0

The all-atom clashscore is defined as the number of clashes found per 1000 atoms (including hydrogen atoms). The all-atom clashscore for this structure is 11.

All (388) close contacts within the same asymmetric unit are listed below, sorted by their clash magnitude.

Atom-1	Atom-2	Interatomic distance (Å)	Clash overlap (Å)
2:B:238:THR:HG21	2:B:318:ARG:HD2	1.33	1.08
4:F:163:SER:HB3	4:F:169:LEU:HD21	1.41	1.03
1:C:264:ARG:HD3	9:C:504:MES:H81	1.37	1.01
4:F:71:LEU:HD13	4:F:298:ILE:HD13	1.49	0.95
1:C:71:GLU:OE1	1:C:73:THR:HB	1.67	0.94
2:D:189:VAL:HG21	2:D:415:MET:CE	1.97	0.94
4:F:31:ARG:HD3	4:F:32:LYS:H	1.33	0.91
4:F:137:ARG:O	4:F:137:ARG:NH1	2.05	0.90
2:D:375:GLN:HG3	2:D:419:VAL:HG13	1.55	0.87
1:A:71:GLU:OE1	1:A:73:THR:HB	1.74	0.87
2:D:189:VAL:HG21	2:D:415:MET:HE2	1.55	0.86
2:D:149:THR:HG21	2:D:191:GLN:HG3	1.59	0.85
4:F:172:PHE:O	4:F:176:GLN:HG2	1.78	0.81

Continued on next page...

Continued from previous page...

Atom-1	Atom-2	Interatomic distance (Å)	Clash overlap (Å)
1:C:241:SER:HA	1:C:249:ASN:HD21	1.45	0.79
4:F:31:ARG:HD3	4:F:32:LYS:N	1.98	0.78
2:D:33:THR:O	2:D:58:LYS:NZ	2.13	0.76
1:C:249:ASN:ND2	1:C:356:ASN:OD1	2.19	0.76
2:D:21:TRP:CZ3	2:D:61:PRO:HB3	2.21	0.76
4:F:137:ARG:HH12	4:F:141:GLY:HA3	1.49	0.76
1:C:211:ASP:OD2	1:C:304:LYS:NZ	2.16	0.76
2:D:189:VAL:HG21	2:D:415:MET:HE3	1.69	0.75
2:B:238:THR:HG21	2:B:318:ARG:CD	2.14	0.75
2:D:67:ASP:OD1	2:D:69:GLU:HG3	1.87	0.74
4:F:223:THR:HG22	4:F:260:ASN:O	1.87	0.74
2:D:86:ARG:HD2	2:D:89:ASN:OD1	1.88	0.73
1:C:221:ARG:HD3	2:D:323:MET:HG2	1.71	0.72
2:D:285:THR:OG1	2:D:288:GLU:HG3	1.89	0.72
1:C:381:THR:HG22	1:C:383:ALA:H	1.55	0.72
2:D:134:GLN:HA	2:D:165:ASN:O	1.91	0.70
4:F:209:HIS:HB2	4:F:310:GLN:CG	2.23	0.68
2:B:324:LYS:HE2	2:B:328:GLU:OE2	1.94	0.68
2:B:101:TRP:CE3	2:B:187:LEU:HD13	2.29	0.68
2:B:177:ASP:O	1:C:352:LYS:HE2	1.94	0.68
4:F:10:ASN:O	4:F:10:ASN:ND2	2.17	0.68
2:D:73:MET:HE2	2:D:77:ARG:HH12	1.58	0.67
2:B:21:TRP:CZ3	2:B:61:PRO:HB3	2.29	0.67
2:D:189:VAL:CG2	2:D:415:MET:HE3	2.25	0.67
2:D:105:HIS:CE1	2:D:149:THR:HG22	2.30	0.67
2:D:375:GLN:CG	2:D:419:VAL:HG13	2.24	0.67
4:F:187:GLU:O	4:F:189:PRO:HD3	1.95	0.66
4:F:225:SER:HB3	4:F:252:ASN:HB3	1.75	0.66
1:A:187:SER:HB3	1:A:391:LEU:HD21	1.77	0.66
2:D:203:ASP:OD1	2:D:380:ARG:NH2	2.28	0.66
2:D:141:GLY:HA3	8:D:501:GDP:O3A	1.96	0.65
4:F:14:TYR:HB3	4:F:41:LEU:HD13	1.78	0.65
2:B:238:THR:OG1	2:B:316:ILE:HG21	1.97	0.65
1:C:398:MET:HE1	1:C:404:PHE:CD2	2.31	0.65
1:A:381:THR:HG22	1:A:383:ALA:H	1.61	0.64
1:C:332:ILE:HG22	1:C:336:LYS:HE2	1.77	0.64
2:B:135:LEU:CD2	2:B:152:ILE:HD11	2.27	0.64
2:B:179:VAL:HG22	1:C:258:ASN:OD1	1.98	0.64
2:D:272:PRO:HB3	2:D:284:LEU:HD21	1.78	0.64
4:F:222:ARG:O	4:F:241:THR:HG21	1.97	0.64
2:B:178:THR:O	2:B:181:GLU:HG3	1.98	0.63

Continued on next page...

Continued from previous page...

Atom-1	Atom-2	Interatomic distance (Å)	Clash overlap (Å)
2:B:170:MET:HG3	2:B:377:LEU:HD21	1.80	0.63
2:D:33:THR:HG23	2:D:58:LYS:NZ	2.14	0.62
1:A:211:ASP:OD2	1:A:304:LYS:NZ	2.31	0.62
1:C:221:ARG:HD3	2:D:323:MET:CG	2.28	0.62
4:F:209:HIS:HB2	4:F:310:GLN:HG3	1.81	0.62
3:E:140:LYS:HG3	3:E:140:LYS:O	1.99	0.62
1:A:399:TYR:O	1:A:402:ARG:NH1	2.32	0.62
4:F:32:LYS:HG3	4:F:33:ASP:OD2	1.99	0.62
2:D:356:ILE:N	2:D:356:ILE:HD12	2.15	0.62
1:A:187:SER:CB	1:A:391:LEU:HD21	2.29	0.61
4:F:31:ARG:HA	4:F:31:ARG:NE	2.15	0.61
2:B:285:THR:OG1	2:B:288:GLU:HG3	2.00	0.61
2:B:201:CYS:SG	2:B:265:PHE:HB3	2.40	0.61
2:D:105:HIS:HE1	2:D:149:THR:HG22	1.65	0.61
1:A:178:SER:O	2:B:350:LYS:NZ	2.34	0.61
2:D:97:ALA:HB2	2:D:143:THR:OG1	2.01	0.61
2:B:135:LEU:HD23	2:B:152:ILE:HD11	1.83	0.60
2:D:25:SER:HB3	2:D:30:ILE:HD11	1.83	0.60
2:D:166:THR:OG1	2:D:199:THR:HG22	2.02	0.60
2:D:211:CYS:HA	2:D:215:LEU:HB2	1.84	0.59
1:A:210:TYR:CE2	1:A:214:ARG:HD2	2.37	0.59
4:F:247:LYS:HE3	4:F:253:TYR:CD1	2.37	0.59
1:C:63:PRO:HG2	1:C:87:PHE:CE1	2.37	0.59
2:D:80:PRO:O	2:D:81:PHE:HB2	2.03	0.59
1:C:398:MET:HE1	1:C:404:PHE:HD2	1.66	0.59
2:D:31:ASP:OD1	2:D:33:THR:HB	2.03	0.59
2:B:2:ARG:NH1	2:B:129:CYS:SG	2.76	0.58
4:F:197:ARG:HB3	4:F:224:SER:O	2.03	0.58
2:D:6:HIS:HE2	2:D:8:GLN:HG2	1.67	0.58
3:E:129:HIS:HA	3:E:132:GLU:HG2	1.85	0.58
4:F:10:ASN:HD22	4:F:10:ASN:C	2.05	0.58
2:D:185:ALA:O	2:D:189:VAL:HG13	2.03	0.58
2:B:165:ASN:HD22	2:B:198:GLU:HB2	1.69	0.58
3:E:81:GLU:OE2	12:E:201:HOH:O	2.17	0.58
4:F:246:GLN:C	4:F:247:LYS:HD2	2.24	0.58
4:F:223:THR:HG21	4:F:257:GLU:OE2	2.04	0.58
1:A:120:ASP:O	1:A:124:LYS:HG2	2.04	0.58
2:D:179:VAL:HB	2:D:388:MET:CE	2.34	0.57
4:F:3:THR:HG23	4:F:38:ASN:H	1.69	0.57
4:F:88:SER:OG	4:F:89:GLU:HA	2.04	0.57
4:F:71:LEU:CD1	4:F:298:ILE:HD13	2.30	0.57

Continued on next page...

Continued from previous page...

Atom-1	Atom-2	Interatomic distance (Å)	Clash overlap (Å)
4:F:74:LYS:H	4:F:74:LYS:HD3	1.69	0.57
1:C:292:THR:HG22	1:C:335:ILE:CD1	2.35	0.56
4:F:200:ASP:OD2	4:F:241:THR:HB	2.05	0.56
4:F:216:TYR:CE2	4:F:218:GLU:HB2	2.40	0.56
1:A:36:MET:HB3	1:A:61:HIS:CE1	2.41	0.56
2:B:189:VAL:HB	2:B:415:MET:CE	2.35	0.56
1:A:188:ILE:HG13	1:A:425:MET:HG3	1.87	0.56
2:B:189:VAL:HG11	2:B:415:MET:HE2	1.87	0.56
1:A:112:LYS:HD2	3:E:54:LEU:HB3	1.88	0.56
2:B:130:LEU:O	2:B:162:ARG:NH1	2.38	0.56
1:C:166:LYS:HE2	1:C:197:HIS:O	2.04	0.56
4:F:191:LEU:HD12	4:F:197:ARG:O	2.06	0.56
2:B:21:TRP:CE3	2:B:61:PRO:HB3	2.41	0.56
2:B:309:ARG:NH1	2:B:343:GLU:OE1	2.35	0.56
1:C:178:SER:O	2:D:350:LYS:HE2	2.06	0.56
4:F:138:ARG:HH11	4:F:143:GLU:HB3	1.70	0.56
3:E:137:LYS:O	3:E:140:LYS:HG2	2.05	0.56
2:D:31:ASP:HB2	2:D:32:PRO:CD	2.36	0.55
1:C:248:LEU:HD12	1:C:357:TYR:OH	2.06	0.55
2:D:81:PHE:O	2:D:84:ILE:HG22	2.06	0.55
4:F:205:VAL:HG21	4:F:291:ILE:HD13	1.88	0.55
2:D:32:PRO:HB3	2:D:81:PHE:HA	1.89	0.55
1:A:265:ILE:HG23	1:A:432:TYR:CZ	2.41	0.55
2:B:162:ARG:O	9:B:502:MES:H71	2.06	0.55
1:C:174:ALA:HB1	1:C:207:GLU:HB2	1.88	0.55
1:A:390:ARG:HD2	4:F:54:HIS:CD2	2.42	0.55
2:D:55:THR:O	2:D:58:LYS:HG2	2.07	0.55
2:B:94:GLN:HB3	1:C:1:MET:HE1	1.88	0.55
1:C:399:TYR:O	1:C:402:ARG:NH2	2.37	0.55
1:C:4:CYS:HB3	1:C:136:LEU:CD1	2.36	0.55
2:D:21:TRP:CH2	2:D:61:PRO:HB3	2.42	0.54
4:F:71:LEU:HD21	4:F:294:CYS:HB3	1.89	0.54
2:B:42:LEU:CD2	2:B:243:PRO:HD2	2.38	0.54
2:D:103:LYS:HG2	2:D:401:GLU:OE2	2.07	0.54
4:F:162:ILE:HD11	4:F:240:LEU:HD21	1.90	0.54
2:B:135:LEU:HB3	2:B:166:THR:HG22	1.87	0.54
2:D:25:SER:HB3	2:D:30:ILE:CD1	2.37	0.54
1:A:265:ILE:HG23	1:A:432:TYR:CE1	2.43	0.54
4:F:137:ARG:NH1	4:F:141:GLY:HA3	2.19	0.54
4:F:15:ALA:O	4:F:19:ARG:HG3	2.07	0.54
4:F:219:GLY:HA3	4:F:264:PHE:CZ	2.43	0.54

Continued on next page...

Continued from previous page...

Atom-1	Atom-2	Interatomic distance (Å)	Clash overlap (Å)
2:D:293:MET:CG	2:D:367:PHE:HB2	2.37	0.54
4:F:3:THR:O	4:F:38:ASN:HB2	2.08	0.54
1:C:209:ILE:HD11	1:C:302:MET:SD	2.48	0.53
2:D:73:MET:CE	2:D:77:ARG:HH12	2.21	0.53
4:F:137:ARG:HH12	4:F:141:GLY:CA	2.20	0.53
2:D:12:CYS:HB2	8:D:501:GDP:C8	2.43	0.53
2:B:33:THR:HG22	2:B:58:LYS:NZ	2.24	0.53
2:B:94:GLN:HB3	1:C:1:MET:CE	2.38	0.53
1:C:71:GLU:HB2	1:C:98:ASP:HB3	1.90	0.53
2:D:116:VAL:CG1	2:D:151:LEU:HD11	2.38	0.53
4:F:100:ILE:HG13	4:F:182:ILE:HD12	1.89	0.53
4:F:202:ARG:NE	4:F:318:ASP:OD2	2.31	0.53
1:C:162:GLY:HA2	3:E:94:ILE:HD11	1.90	0.53
4:F:184:LYS:O	11:F:402:ACP:N6	2.40	0.53
1:A:25:CYS:HB3	1:A:30:ILE:O	2.09	0.53
2:B:392:LYS:N	2:B:392:LYS:HD2	2.24	0.52
2:D:110:ALA:O	2:D:113:VAL:HG12	2.09	0.52
2:B:31:ASP:OD1	2:B:33:THR:HB	2.10	0.52
2:B:272:PRO:HD2	2:B:361:LEU:HD13	1.92	0.52
1:C:71:GLU:HG2	1:C:72:PRO:HD2	1.91	0.52
2:D:45:GLU:OE2	2:D:243:PRO:HG3	2.10	0.52
4:F:20:LEU:O	4:F:24:THR:HG23	2.09	0.52
4:F:146:VAL:HG21	4:F:233:PHE:CZ	2.45	0.52
1:C:165:SER:HA	1:C:199:ASP:OD2	2.10	0.52
3:E:72:LEU:O	3:E:76:ARG:HG2	2.10	0.52
4:F:137:ARG:NH2	4:F:143:GLU:HG3	2.23	0.52
1:A:21:TRP:CZ3	1:A:63:PRO:HB3	2.44	0.52
1:C:221:ARG:CD	2:D:323:MET:HG2	2.39	0.52
1:A:18:ASN:OD1	1:A:78:VAL:HG22	2.10	0.52
2:D:73:MET:CG	2:D:77:ARG:HH22	2.22	0.52
1:C:171:ILE:HD12	1:C:171:ILE:N	2.25	0.52
2:D:54:ALA:HB3	2:D:58:LYS:HB2	1.92	0.52
4:F:244:CYS:O	4:F:247:LYS:HG2	2.09	0.52
2:B:31:ASP:HB2	2:B:32:PRO:CD	2.40	0.52
2:B:35:SER:OG	2:B:58:LYS:NZ	2.36	0.52
2:D:169:VAL:HA	2:D:202:ILE:O	2.10	0.51
1:A:154:MET:HG3	1:A:194:THR:HG23	1.92	0.51
1:A:261:PRO:HD2	12:A:614:HOH:O	2.10	0.51
1:C:344:VAL:HG21	1:C:346:TRP:CE2	2.45	0.51
1:A:283:HIS:HD2	1:A:285:GLN:NE2	2.07	0.51
4:F:131:PHE:CE2	4:F:182:ILE:HG21	2.47	0.50

Continued on next page...

Continued from previous page...

Atom-1	Atom-2	Interatomic distance (Å)	Clash overlap (Å)
2:B:293:MET:CE	2:B:365:ALA:HB1	2.42	0.50
1:C:171:ILE:N	1:C:171:ILE:CD1	2.74	0.50
1:C:21:TRP:CZ3	1:C:63:PRO:HB3	2.47	0.50
2:D:306:ARG:NH2	2:D:337:ASN:OD1	2.45	0.50
4:F:128:ARG:HH21	4:F:170:LEU:HD13	1.76	0.50
1:C:96:LYS:NZ	2:D:128:ASP:O	2.26	0.50
4:F:192:LEU:HD12	4:F:192:LEU:H	1.75	0.50
2:D:170:MET:HE3	2:D:201:CYS:HA	1.94	0.50
2:D:179:VAL:HB	2:D:388:MET:HE3	1.93	0.50
4:F:197:ARG:NH1	4:F:257:GLU:OE2	2.44	0.50
4:F:138:ARG:NH2	4:F:184:LYS:HE2	2.27	0.50
4:F:205:VAL:HG21	4:F:291:ILE:HG21	1.92	0.50
1:C:398:MET:CE	1:C:404:PHE:CE2	2.95	0.50
2:B:2:ARG:HA	2:B:129:CYS:O	2.13	0.49
4:F:16:GLU:O	4:F:20:LEU:HG	2.11	0.49
1:A:71:GLU:HB2	1:A:98:ASP:HB3	1.94	0.49
1:C:320:ARG:HA	1:C:356:ASN:O	2.13	0.49
4:F:242:ASN:HD21	11:F:402:ACP:C3B	2.25	0.49
1:A:88:HIS:HE1	1:A:90:GLU:HG3	1.76	0.49
1:A:247:ALA:HB3	3:E:19:SER:OG	2.12	0.49
4:F:74:LYS:HD3	4:F:74:LYS:N	2.28	0.49
4:F:245:ILE:HG22	4:F:245:ILE:O	2.13	0.49
2:D:290:THR:HG22	2:D:333:VAL:HG21	1.94	0.49
1:C:255:PHE:CD1	1:C:352:LYS:HD3	2.48	0.49
2:D:324:LYS:O	2:D:328:GLU:HG3	2.12	0.49
1:C:275:VAL:HG13	1:C:368:LEU:HD21	1.95	0.48
2:D:73:MET:HG2	2:D:77:ARG:NH2	2.27	0.48
4:F:287:ILE:O	4:F:291:ILE:HG13	2.13	0.48
4:F:137:ARG:HH22	4:F:143:GLU:HG3	1.77	0.48
4:F:161:LEU:HD23	4:F:172:PHE:CE2	2.48	0.48
1:A:159:VAL:HG23	1:A:160:ASP:OD1	2.13	0.48
1:C:71:GLU:OE1	1:C:73:THR:CB	2.52	0.48
1:C:264:ARG:HD3	9:C:504:MES:C8	2.26	0.48
4:F:74:LYS:H	4:F:74:LYS:CD	2.25	0.48
4:F:216:TYR:CZ	4:F:218:GLU:HB2	2.48	0.48
4:F:307:LEU:HD22	4:F:308:HIS:CE1	2.48	0.48
1:A:141:PHE:CE1	1:A:170:SER:HB3	2.49	0.48
2:D:21:TRP:CE3	2:D:61:PRO:HB3	2.47	0.48
1:A:209:ILE:HD11	1:A:302:MET:SD	2.54	0.48
2:D:330:MET:O	2:D:334:GLN:HG3	2.12	0.48
1:A:233:GLN:HG3	1:A:368:LEU:CD1	2.44	0.48

Continued on next page...

Continued from previous page...

Atom-1	Atom-2	Interatomic distance (Å)	Clash overlap (Å)
2:D:64:ILE:HG13	2:D:89:ASN:HD22	1.78	0.48
2:B:293:MET:HE3	2:B:365:ALA:HB1	1.95	0.48
4:F:92:THR:O	4:F:326:LYS:HE2	2.14	0.47
2:B:189:VAL:HB	2:B:415:MET:HE3	1.96	0.47
2:B:295:ASP:HA	9:B:503:MES:O3S	2.14	0.47
4:F:209:HIS:HB2	4:F:310:GLN:HG2	1.94	0.47
1:C:324:VAL:HG22	12:C:611:HOH:O	2.13	0.47
4:F:147:TRP:O	4:F:162:ILE:HG23	2.13	0.47
4:F:242:ASN:HD21	11:F:402:ACP:H3B2	1.80	0.47
1:A:260:VAL:HG11	1:A:266:HIS:HB3	1.96	0.47
4:F:199:PHE:HZ	4:F:321:VAL:HB	1.78	0.47
2:B:67:ASP:O	2:B:92:PHE:HA	2.14	0.47
2:B:135:LEU:HD22	2:B:152:ILE:HD11	1.95	0.47
1:C:93:ILE:HD11	1:C:121:ARG:HG3	1.96	0.47
2:D:7:ILE:O	2:D:135:LEU:HD12	2.15	0.47
2:D:70:PRO:HG3	2:D:94:GLN:HA	1.97	0.47
2:D:204:ASN:HA	2:D:207:LEU:HD12	1.97	0.47
2:B:179:VAL:HG12	1:C:348:PRO:HG2	1.97	0.47
1:C:167:LEU:HA	1:C:200:CYS:O	2.14	0.47
1:C:398:MET:CE	1:C:404:PHE:CD2	2.98	0.47
2:D:68:LEU:H	2:D:143:THR:HG21	1.80	0.47
4:F:247:LYS:HD2	4:F:247:LYS:N	2.29	0.47
1:A:71:GLU:HG2	1:A:72:PRO:HD2	1.95	0.47
4:F:190:LEU:HB2	4:F:322:ASP:O	2.15	0.47
2:D:174:LYS:HE3	2:D:208:TYR:CD2	2.50	0.46
4:F:3:THR:HG23	4:F:37:PHE:HA	1.97	0.46
2:B:169:VAL:HA	2:B:202:ILE:O	2.16	0.46
4:F:225:SER:CB	4:F:252:ASN:HB3	2.43	0.46
1:A:88:HIS:CE1	1:A:90:GLU:HG3	2.51	0.46
2:B:197:ASP:OD1	9:B:502:MES:H62	2.15	0.46
1:C:254:GLU:HG2	1:C:352:LYS:HE3	1.97	0.46
2:D:143:THR:HB	8:D:501:GDP:O1B	2.14	0.46
1:A:357:TYR:CE2	3:E:17:GLY:HA2	2.51	0.46
4:F:135:TYR:OH	4:F:165:GLU:HA	2.15	0.46
2:D:179:VAL:HB	2:D:388:MET:HE1	1.97	0.46
2:D:226:ASN:OD1	8:D:501:GDP:N1	2.34	0.46
1:C:244:PHE:HB2	1:C:356:ASN:ND2	2.31	0.46
2:D:25:SER:CB	2:D:30:ILE:HD11	2.45	0.46
2:D:293:MET:HG2	2:D:367:PHE:HB2	1.97	0.46
4:F:197:ARG:HH12	4:F:257:GLU:CD	2.18	0.46
2:D:268:PRO:HA	2:D:367:PHE:O	2.16	0.46

Continued on next page...

Continued from previous page...

Atom-1	Atom-2	Interatomic distance (Å)	Clash overlap (Å)
2:D:31:ASP:HB2	2:D:32:PRO:HD2	1.97	0.45
1:A:147:SER:HB2	1:A:190:THR:HB	1.98	0.45
2:B:212:PHE:HA	2:B:217:LEU:O	2.16	0.45
1:C:210:TYR:CE2	1:C:214:ARG:HD3	2.52	0.45
4:F:341:LYS:HG3	4:F:342:LEU:HD23	1.97	0.45
2:B:324:LYS:O	2:B:328:GLU:HG3	2.15	0.45
4:F:88:SER:CB	4:F:89:GLU:HA	2.45	0.45
1:A:2:ARG:O	1:A:51:THR:HG23	2.16	0.45
2:D:284:LEU:HD12	2:D:284:LEU:N	2.32	0.45
4:F:2:TYR:CZ	4:F:359:PHE:HB3	2.52	0.45
1:A:166:LYS:HE2	1:A:197:HIS:O	2.17	0.45
4:F:307:LEU:HD23	4:F:307:LEU:HA	1.86	0.45
1:C:43:GLY:HA2	1:C:56:THR:O	2.16	0.45
1:A:21:TRP:CH2	1:A:63:PRO:HB3	2.52	0.45
2:B:73:MET:HE3	2:B:73:MET:HB3	1.88	0.45
1:A:133:GLN:OE1	1:A:252:LEU:HG	2.17	0.44
2:D:377:LEU:C	2:D:377:LEU:HD23	2.37	0.44
1:A:262:TYR:CE1	1:A:346:TRP:CZ2	3.06	0.44
1:A:345:ASP:O	3:E:28:SER:N	2.51	0.44
4:F:192:LEU:HD12	4:F:192:LEU:N	2.32	0.44
1:A:104:ALA:HB2	1:A:413:MET:SD	2.57	0.44
2:B:103:LYS:HA	2:B:107:THR:OG1	2.18	0.44
2:D:73:MET:HG2	2:D:77:ARG:HH22	1.82	0.44
4:F:207:VAL:HG21	4:F:295:LEU:HD13	2.00	0.44
2:B:31:ASP:HB2	2:B:32:PRO:HD2	1.99	0.44
1:C:12:ALA:HB3	1:C:140:SER:HB3	1.99	0.44
4:F:163:SER:CB	4:F:169:LEU:HD21	2.30	0.44
9:B:502:MES:H81	9:B:502:MES:H51	1.63	0.44
1:C:210:TYR:CZ	1:C:222:PRO:HD2	2.53	0.44
1:A:88:HIS:O	1:A:91:GLN:HG3	2.18	0.44
1:A:401:LYS:HG3	2:B:344:TRP:CE3	2.53	0.44
2:B:52:ASN:HB2	2:B:60:VAL:HG13	1.99	0.44
2:B:317:PHE:HB2	2:B:353:VAL:HG22	2.00	0.44
2:D:28:HIS:HA	2:D:43:GLN:HB3	2.00	0.43
4:F:162:ILE:O	4:F:163:SER:HB2	2.17	0.43
4:F:275:LEU:HD23	4:F:325:LEU:HD11	1.99	0.43
1:A:349:THR:O	3:E:24:LEU:HB2	2.18	0.43
1:C:215:ARG:CZ	1:C:299:ALA:HB1	2.47	0.43
2:B:104:GLY:O	2:B:109:GLY:HA3	2.19	0.43
1:C:18:ASN:OD1	1:C:78:VAL:HG22	2.18	0.43
2:D:318:ARG:NH2	2:D:356:ILE:O	2.49	0.43

Continued on next page...

Continued from previous page...

Atom-1	Atom-2	Interatomic distance (Å)	Clash overlap (Å)
4:F:205:VAL:CG2	4:F:291:ILE:HD13	2.48	0.43
2:B:73:MET:CE	2:B:92:PHE:HD2	2.32	0.43
2:D:5:VAL:HB	2:D:133:PHE:CD1	2.54	0.43
2:D:203:ASP:CG	2:D:380:ARG:HH22	2.22	0.43
2:D:249:ASP:OD2	2:D:252:LYS:HD2	2.18	0.43
2:B:12:CYS:HB2	8:B:501:GDP:C8	2.53	0.43
2:D:62:ARG:HG3	2:D:123:GLU:OE2	2.18	0.43
4:F:142:ARG:CD	4:F:142:ARG:O	2.66	0.43
4:F:331:GLU:OE2	11:F:402:ACP:O2A	2.37	0.43
2:D:67:ASP:CG	2:D:69:GLU:HG3	2.38	0.43
1:A:46:ASP:OD2	1:A:46:ASP:N	2.48	0.43
2:D:206:ALA:O	2:D:210:ILE:HG13	2.19	0.43
4:F:163:SER:HB3	4:F:169:LEU:CD2	2.29	0.43
4:F:282:SER:HB2	4:F:325:LEU:HD13	2.01	0.43
3:E:52:LYS:O	3:E:53:LYS:HE2	2.19	0.43
4:F:34:ASN:OD1	4:F:35:PRO:HD2	2.18	0.43
4:F:186:LEU:H	11:F:402:ACP:C2	2.32	0.43
1:A:69:ASP:O	1:A:94:THR:HA	2.18	0.43
2:D:116:VAL:HG11	2:D:151:LEU:HD11	2.01	0.43
2:D:286:VAL:HB	2:D:287:PRO:HD3	2.00	0.43
1:A:161:TYR:HB3	1:A:164:LYS:CG	2.49	0.42
1:A:294:ALA:HB1	1:A:300:ASN:ND2	2.34	0.42
1:C:262:TYR:CD1	9:C:504:MES:H32	2.54	0.42
1:C:291:ILE:HD13	1:C:373:ARG:HG3	2.02	0.42
3:E:80:ARG:HA	3:E:83:ILE:HG22	2.01	0.42
1:C:7:ILE:HG21	1:C:153:LEU:HD21	2.00	0.42
4:F:3:THR:HG23	4:F:38:ASN:N	2.33	0.42
1:A:229:ARG:HD2	1:A:363:VAL:HG21	2.01	0.42
1:C:188:ILE:HG13	1:C:425:MET:HG3	2.01	0.42
1:C:343:PHE:CG	1:C:349:THR:HG22	2.55	0.42
2:D:7:ILE:HG21	2:D:151:LEU:CD2	2.50	0.42
4:F:169:LEU:N	4:F:169:LEU:HD22	2.34	0.42
4:F:246:GLN:OE1	4:F:260:ASN:ND2	2.53	0.42
4:F:267:PHE:CZ	4:F:271:LEU:HD11	2.54	0.42
1:A:291:ILE:HD13	1:A:373:ARG:HG3	2.02	0.42
2:D:6:HIS:CD2	2:D:21:TRP:HE1	2.37	0.42
2:D:310:TYR:CE2	2:D:367:PHE:HZ	2.38	0.42
2:D:30:ILE:HD13	2:D:84:ILE:HD11	2.00	0.42
2:D:65:LEU:CD2	2:D:76:VAL:HG11	2.50	0.42
4:F:14:TYR:HA	4:F:17:VAL:HB	2.02	0.42
4:F:192:LEU:HD22	4:F:262:MET:CE	2.49	0.42

Continued on next page...

Continued from previous page...

Atom-1	Atom-2	Interatomic distance (Å)	Clash overlap (Å)
4:F:240:LEU:HD22	11:F:402:ACP:O4'	2.20	0.42
1:A:413:MET:HE3	1:A:417:GLU:HB3	2.02	0.42
2:B:6:HIS:CE1	2:B:21:TRP:HE1	2.38	0.42
2:D:33:THR:CG2	2:D:58:LYS:NZ	2.79	0.42
4:F:100:ILE:HD12	4:F:128:ARG:HA	2.02	0.42
4:F:187:GLU:C	4:F:189:PRO:HD3	2.40	0.42
1:C:21:TRP:CH2	1:C:63:PRO:HB3	2.55	0.42
4:F:304:THR:HG21	4:F:311:SER:HB2	2.02	0.42
3:E:25:LYS:HA	3:E:26:PRO:HD3	1.92	0.42
4:F:229:ASN:O	4:F:239:HIS:CE1	2.74	0.41
2:B:284:LEU:N	2:B:284:LEU:HD12	2.35	0.41
1:A:344:VAL:HG21	1:A:346:TRP:CE2	2.55	0.41
2:B:190:HIS:ND1	2:B:414:ASN:ND2	2.68	0.41
4:F:229:ASN:O	4:F:239:HIS:HE1	2.03	0.41
1:A:88:HIS:N	1:A:91:GLN:OE1	2.50	0.41
1:A:346:TRP:CZ3	1:A:347:CYS:SG	3.14	0.41
2:D:101:TRP:NE1	2:D:146:GLY:HA2	2.35	0.41
2:D:417:ASP:O	2:D:421:GLU:HG3	2.20	0.41
4:F:247:LYS:HE3	4:F:253:TYR:CE1	2.55	0.41
1:A:192:HIS:CG	1:A:421:ALA:HA	2.56	0.41
4:F:170:LEU:N	4:F:170:LEU:HD23	2.35	0.41
4:F:191:LEU:N	4:F:191:LEU:HD22	2.36	0.41
4:F:78:VAL:HG21	4:F:181:VAL:HG11	2.01	0.41
4:F:192:LEU:CD2	4:F:262:MET:CE	2.99	0.41
1:A:12:ALA:HB3	1:A:140:SER:HB3	2.02	0.41
1:A:161:TYR:HB3	1:A:164:LYS:HG2	2.02	0.41
2:B:33:THR:HG22	2:B:58:LYS:HZ1	1.86	0.41
2:B:296:SER:N	9:B:503:MES:O3S	2.47	0.41
9:B:503:MES:H81	9:B:503:MES:H51	1.47	0.41
2:D:170:MET:HG3	2:D:377:LEU:HD11	2.03	0.41
4:F:218:GLU:HA	4:F:218:GLU:OE1	2.21	0.41
2:D:27:GLU:OE1	2:D:318:ARG:NH2	2.42	0.41
4:F:58:LEU:HD23	4:F:58:LEU:HA	1.79	0.40
2:D:22:GLU:HG3	2:D:81:PHE:CE2	2.56	0.40
2:D:149:THR:HG21	2:D:191:GLN:CG	2.40	0.40
4:F:149:ALA:HB3	4:F:161:LEU:HB3	2.02	0.40
2:B:139:LEU:HD12	2:B:170:MET:SD	2.60	0.40
1:C:409:VAL:HA	1:C:413:MET:O	2.21	0.40
2:D:211:CYS:CB	2:D:220:PRO:HG3	2.51	0.40
2:D:323:MET:SD	2:D:323:MET:N	2.92	0.40
4:F:206:LEU:HD21	4:F:354:ALA:HB2	2.04	0.40

Continued on next page...

Continued from previous page...

Atom-1	Atom-2	Interatomic distance (Å)	Clash overlap (Å)
1:A:2:ARG:HB3	1:A:133:GLN:HG3	2.03	0.40
1:C:142:GLY:HA3	1:C:183:GLU:OE2	2.21	0.40
2:D:65:LEU:HD21	2:D:76:VAL:HG11	2.02	0.40
3:E:52:LYS:HA	3:E:52:LYS:HD3	1.87	0.40
2:B:237:THR:O	2:B:241:ARG:HG3	2.21	0.40
1:C:97:GLU:HG3	2:D:2:ARG:NH1	2.36	0.40

There are no symmetry-related clashes.

5.3 Torsion angles [i](#)

5.3.1 Protein backbone [i](#)

In the following table, the Percentiles column shows the percent Ramachandran outliers of the chain as a percentile score with respect to all X-ray entries followed by that with respect to entries of similar resolution.

The Analysed column shows the number of residues for which the backbone conformation was analysed, and the total number of residues.

Mol	Chain	Analysed	Favoured	Allowed	Outliers	Percentiles	
1	A	435/450 (97%)	423 (97%)	12 (3%)	0	100	100
1	C	438/450 (97%)	424 (97%)	14 (3%)	0	100	100
2	B	426/445 (96%)	418 (98%)	7 (2%)	1 (0%)	47	73
2	D	417/445 (94%)	409 (98%)	8 (2%)	0	100	100
3	E	117/143 (82%)	113 (97%)	4 (3%)	0	100	100
4	F	322/384 (84%)	295 (92%)	27 (8%)	0	100	100
All	All	2155/2317 (93%)	2082 (97%)	72 (3%)	1 (0%)	100	100

All (1) Ramachandran outliers are listed below:

Mol	Chain	Res	Type
2	B	247	ASN

5.3.2 Protein sidechains [i](#)

In the following table, the Percentiles column shows the percent sidechain outliers of the chain as a percentile score with respect to all X-ray entries followed by that with respect to entries of similar

resolution.

The Analysed column shows the number of residues for which the sidechain conformation was analysed, and the total number of residues.

Mol	Chain	Analysed	Rotameric	Outliers	Percentiles	
1	A	368/378 (97%)	367 (100%)	1 (0%)	92	98
1	C	371/378 (98%)	359 (97%)	12 (3%)	39	68
2	B	370/383 (97%)	363 (98%)	7 (2%)	57	82
2	D	364/383 (95%)	354 (97%)	10 (3%)	44	74
3	E	109/127 (86%)	108 (99%)	1 (1%)	78	92
4	F	299/342 (87%)	284 (95%)	15 (5%)	24	51
All	All	1881/1991 (94%)	1835 (98%)	46 (2%)	49	77

All (46) residues with a non-rotameric sidechain are listed below:

Mol	Chain	Res	Type
1	A	221	ARG
2	B	42	LEU
2	B	78	SER
2	B	115	SER
2	B	131	GLN
2	B	137	HIS
2	B	238	THR
2	B	359	ARG
1	C	48	SER
1	C	96	LYS
1	C	171	ILE
1	C	177	VAL
1	C	218	ASP
1	C	221	ARG
1	C	241	SER
1	C	251	ASP
1	C	318	LEU
1	C	347	CYS
1	C	379	SER
1	C	401	LYS
2	D	26	ASP
2	D	33	THR
2	D	35	SER
2	D	39	ASP
2	D	69	GLU
2	D	75	SER

Continued on next page...

Continued from previous page...

Mol	Chain	Res	Type
2	D	77	ARG
2	D	137	HIS
2	D	246	LEU
2	D	247	ASN
3	E	112	ARG
4	F	10	ASN
4	F	12	SER
4	F	31	ARG
4	F	33	ASP
4	F	70	LYS
4	F	74	LYS
4	F	101	TYR
4	F	142	ARG
4	F	171	ASP
4	F	192	LEU
4	F	199	PHE
4	F	211	TYR
4	F	222	ARG
4	F	260	ASN
4	F	299	GLU

Sometimes sidechains can be flipped to improve hydrogen bonding and reduce clashes. All (8) such sidechains are listed below:

Mol	Chain	Res	Type
2	B	6	HIS
1	C	133	GLN
1	C	249	ASN
1	C	356	ASN
2	D	347	ASN
4	F	242	ASN
4	F	260	ASN
4	F	310	GLN

5.3.3 RNA [i](#)

There are no RNA molecules in this entry.

5.4 Non-standard residues in protein, DNA, RNA chains [i](#)

There are no non-standard protein/DNA/RNA residues in this entry.

5.5 Carbohydrates [i](#)

There are no monosaccharides in this entry.

5.6 Ligand geometry [i](#)

Of 16 ligands modelled in this entry, 6 are monoatomic - leaving 10 for Mogul analysis.

In the following table, the Counts columns list the number of bonds (or angles) for which Mogul statistics could be retrieved, the number of bonds (or angles) that are observed in the model and the number of bonds (or angles) that are defined in the Chemical Component Dictionary. The Link column lists molecule types, if any, to which the group is linked. The Z score for a bond length (or angle) is the number of standard deviations the observed value is removed from the expected value. A bond length (or angle) with $|Z| > 2$ is considered an outlier worth inspection. RMSZ is the root-mean-square of all Z scores of the bond lengths (or angles).

Mol	Type	Chain	Res	Link	Bond lengths			Bond angles		
					Counts	RMSZ	# Z > 2	Counts	RMSZ	# Z > 2
8	GDP	D	501	-	24,30,30	0.95	1 (4%)	30,47,47	1.23	4 (13%)
9	MES	B	502	-	12,12,12	2.34	1 (8%)	14,16,16	2.12	4 (28%)
10	GK9	B	504	-	21,25,25	0.90	1 (4%)	22,36,36	1.04	3 (13%)
9	MES	C	504	-	12,12,12	2.09	1 (8%)	14,16,16	2.09	4 (28%)
8	GDP	B	501	6	24,30,30	1.07	2 (8%)	30,47,47	1.27	5 (16%)
5	GTP	A	501	6	26,34,34	1.13	2 (7%)	32,54,54	1.46	5 (15%)
10	GK9	D	502	-	21,25,25	0.76	0	22,36,36	1.03	2 (9%)
11	ACP	F	402	6	27,33,33	4.72	10 (37%)	32,52,52	2.28	5 (15%)
9	MES	B	503	-	12,12,12	2.28	1 (8%)	14,16,16	1.87	5 (35%)
5	GTP	C	501	6	26,34,34	1.12	1 (3%)	32,54,54	1.49	8 (25%)

In the following table, the Chirals column lists the number of chiral outliers, the number of chiral centers analysed, the number of these observed in the model and the number defined in the Chemical Component Dictionary. Similar counts are reported in the Torsion and Rings columns. '2' means no outliers of that kind were identified.

Mol	Type	Chain	Res	Link	Chirals	Torsions	Rings
8	GDP	D	501	-	-	6/12/32/32	0/3/3/3
9	MES	B	502	-	-	4/6/14/14	0/1/1/1
10	GK9	B	504	-	-	3/6/16/16	0/4/4/4
9	MES	C	504	-	-	2/6/14/14	0/1/1/1
8	GDP	B	501	6	-	3/12/32/32	0/3/3/3
5	GTP	A	501	6	-	7/18/38/38	0/3/3/3

Continued on next page...

Continued from previous page...

Mol	Type	Chain	Res	Link	Chirals	Torsions	Rings
10	GK9	D	502	-	-	3/6/16/16	0/4/4/4
11	ACP	F	402	6	-	1/15/38/38	0/3/3/3
9	MES	B	503	-	-	1/6/14/14	0/1/1/1
5	GTP	C	501	6	-	5/18/38/38	0/3/3/3

All (20) bond length outliers are listed below:

Mol	Chain	Res	Type	Atoms	Z	Observed(Å)	Ideal(Å)
11	F	402	ACP	O4'-C1'	15.77	1.63	1.41
11	F	402	ACP	C2'-C1'	-14.31	1.32	1.53
9	B	502	MES	C8-S	-7.81	1.66	1.77
9	B	503	MES	C8-S	-7.53	1.66	1.77
11	F	402	ACP	PB-O3A	7.24	1.66	1.58
9	C	504	MES	C8-S	-6.87	1.67	1.77
11	F	402	ACP	O4'-C4'	-5.77	1.32	1.45
5	A	501	GTP	C5-C6	-4.00	1.39	1.47
5	C	501	GTP	C5-C6	-3.66	1.40	1.47
11	F	402	ACP	C6-N6	3.15	1.45	1.34
11	F	402	ACP	O3'-C3'	-3.01	1.35	1.43
10	B	504	GK9	C1-N1	2.94	1.32	1.30
11	F	402	ACP	O2'-C2'	2.91	1.49	1.43
11	F	402	ACP	C2-N3	2.49	1.36	1.32
11	F	402	ACP	C5-C4	-2.49	1.34	1.40
8	D	501	GDP	C6-N1	-2.46	1.34	1.37
8	B	501	GDP	C6-N1	-2.35	1.34	1.37
5	A	501	GTP	C2-N3	2.08	1.38	1.33
11	F	402	ACP	PB-O2B	-2.08	1.51	1.56
8	B	501	GDP	C2'-C1'	-2.02	1.50	1.53

All (45) bond angle outliers are listed below:

Mol	Chain	Res	Type	Atoms	Z	Observed(°)	Ideal(°)
11	F	402	ACP	C5-C6-N6	8.63	133.47	120.35
11	F	402	ACP	N6-C6-N1	-5.60	106.96	118.57
9	C	504	MES	C5-N4-C3	5.44	121.08	108.83
11	F	402	ACP	N3-C2-N1	-5.26	120.45	128.68
9	B	502	MES	C5-N4-C3	4.75	119.51	108.83
9	B	503	MES	C5-N4-C3	4.72	119.45	108.83
9	B	502	MES	O1S-S-C8	4.21	111.98	106.92
5	A	501	GTP	C8-N7-C5	3.57	109.79	102.99
5	C	501	GTP	C8-N7-C5	3.34	109.35	102.99
5	A	501	GTP	C5-C6-N1	3.20	119.61	113.95

Continued on next page...

Continued from previous page...

Mol	Chain	Res	Type	Atoms	Z	Observed(°)	Ideal(°)
5	A	501	GTP	C2-N1-C6	-3.00	119.58	125.10
5	C	501	GTP	C5-C6-N1	2.97	119.19	113.95
9	B	502	MES	O3S-S-C8	2.91	110.47	105.77
11	F	402	ACP	C3'-C2'-C1'	2.91	105.36	100.98
5	A	501	GTP	PA-O3A-PB	-2.89	122.90	132.83
8	B	501	GDP	C5-C6-N1	2.82	118.94	113.95
9	C	504	MES	O3S-S-C8	2.79	110.29	105.77
5	C	501	GTP	PA-O3A-PB	-2.74	123.44	132.83
10	D	502	GK9	N1-C1-N3	-2.73	127.87	130.62
8	B	501	GDP	O6-C6-C5	-2.61	119.27	124.37
10	B	504	GK9	N3-C6-N2	2.61	119.02	116.26
5	C	501	GTP	PB-O3B-PG	-2.54	124.12	132.83
10	D	502	GK9	C1-N3-C6	2.54	118.56	111.04
5	A	501	GTP	PB-O3B-PG	-2.51	124.20	132.83
9	B	503	MES	C6-C5-N4	-2.49	106.32	110.10
10	B	504	GK9	N1-C1-N3	-2.46	128.14	130.62
5	C	501	GTP	O3G-PG-O3B	2.44	112.80	104.64
8	B	501	GDP	PA-O3A-PB	-2.37	124.69	132.83
8	D	501	GDP	C5-C6-N1	2.36	118.12	113.95
9	C	504	MES	C7-N4-C3	2.34	117.22	111.23
8	D	501	GDP	C3'-C2'-C1'	2.34	104.50	100.98
8	D	501	GDP	C8-N7-C5	2.33	107.43	102.99
5	C	501	GTP	O3'-C3'-C4'	-2.32	104.33	111.05
10	B	504	GK9	C1-N3-C6	2.31	117.90	111.04
11	F	402	ACP	O2G-PG-C3B	2.31	112.00	106.40
8	B	501	GDP	C8-N7-C5	2.26	107.29	102.99
5	C	501	GTP	C2-N1-C6	-2.23	121.00	125.10
8	B	501	GDP	O2B-PB-O3A	2.17	111.91	104.64
9	B	503	MES	C7-N4-C5	2.12	116.66	111.23
8	D	501	GDP	O6-C6-C5	-2.11	120.24	124.37
9	C	504	MES	O1S-S-C8	2.09	109.43	106.92
9	B	503	MES	O3S-S-C8	2.07	109.12	105.77
9	B	502	MES	C7-N4-C5	2.06	116.50	111.23
9	B	503	MES	O2S-S-C8	2.04	109.38	106.92
5	C	501	GTP	N1-C2-N3	-2.00	119.58	123.32

There are no chirality outliers.

All (35) torsion outliers are listed below:

Mol	Chain	Res	Type	Atoms
5	A	501	GTP	PB-O3B-PG-O2G
5	A	501	GTP	C5'-O5'-PA-O1A

Continued on next page...

Continued from previous page...

Mol	Chain	Res	Type	Atoms
5	A	501	GTP	C5'-O5'-PA-O2A
5	C	501	GTP	PB-O3B-PG-O3G
5	C	501	GTP	C5'-O5'-PA-O2A
8	B	501	GDP	C5'-O5'-PA-O1A
8	B	501	GDP	C5'-O5'-PA-O2A
8	D	501	GDP	PA-O3A-PB-O2B
8	D	501	GDP	C5'-O5'-PA-O1A
8	D	501	GDP	C5'-O5'-PA-O2A
9	B	502	MES	C8-C7-N4-C5
9	B	502	MES	C7-C8-S-O1S
9	B	502	MES	C7-C8-S-O3S
9	B	503	MES	C8-C7-N4-C5
9	C	504	MES	N4-C7-C8-S
10	B	504	GK9	C3-C6-N2-C16
10	B	504	GK9	C3-C6-N2-C7
10	D	502	GK9	C3-C6-N2-C16
10	D	502	GK9	C3-C6-N2-C7
10	B	504	GK9	N3-C6-N2-C16
10	D	502	GK9	N3-C6-N2-C16
5	C	501	GTP	C5'-O5'-PA-O3A
5	C	501	GTP	C5'-O5'-PA-O1A
11	F	402	ACP	C5'-O5'-PA-O1A
9	B	502	MES	C7-C8-S-O2S
9	C	504	MES	C8-C7-N4-C5
5	A	501	GTP	PB-O3A-PA-O1A
8	D	501	GDP	PA-O3A-PB-O1B
5	A	501	GTP	PB-O3B-PG-O3G
5	C	501	GTP	PB-O3B-PG-O2G
8	D	501	GDP	PA-O3A-PB-O3B
5	A	501	GTP	C5'-O5'-PA-O3A
8	B	501	GDP	C5'-O5'-PA-O3A
8	D	501	GDP	C5'-O5'-PA-O3A
5	A	501	GTP	C4'-C5'-O5'-PA

There are no ring outliers.

6 monomers are involved in 20 short contacts:

Mol	Chain	Res	Type	Clashes	Symm-Clashes
8	D	501	GDP	4	0
9	B	502	MES	3	0
9	C	504	MES	3	0
8	B	501	GDP	1	0

Continued on next page...

Continued from previous page...

Mol	Chain	Res	Type	Clashes	Symm-Clashes
11	F	402	ACP	6	0
9	B	503	MES	3	0

The following is a two-dimensional graphical depiction of Mogul quality analysis of bond lengths, bond angles, torsion angles, and ring geometry for all instances of the Ligand of Interest. In addition, ligands with molecular weight > 250 and outliers as shown on the validation Tables will also be included. For torsion angles, if less than 5% of the Mogul distribution of torsion angles is within 10 degrees of the torsion angle in question, then that torsion angle is considered an outlier. Any bond that is central to one or more torsion angles identified as an outlier by Mogul will be highlighted in the graph. For rings, the root-mean-square deviation (RMSD) between the ring in question and similar rings identified by Mogul is calculated over all ring torsion angles. If the average RMSD is greater than 60 degrees and the minimal RMSD between the ring in question and any Mogul-identified rings is also greater than 60 degrees, then that ring is considered an outlier. The outliers are highlighted in purple. The color gray indicates Mogul did not find sufficient equivalents in the CSD to analyse the geometry.

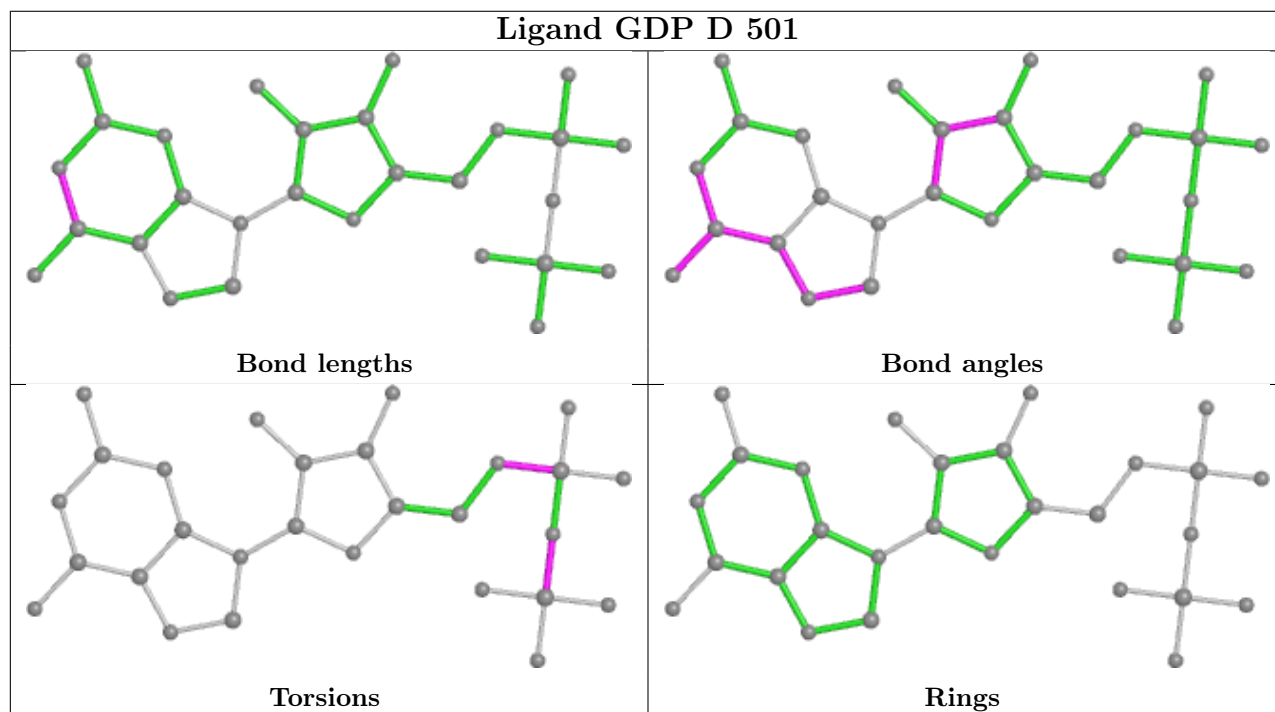

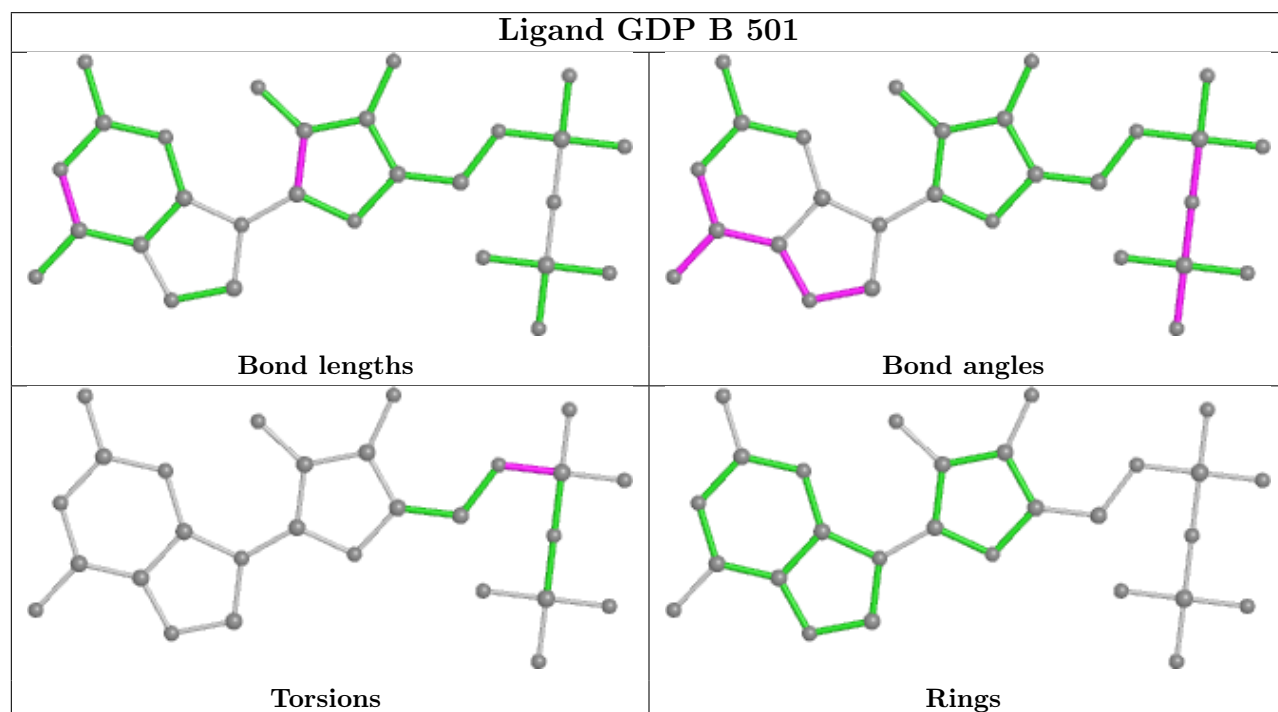
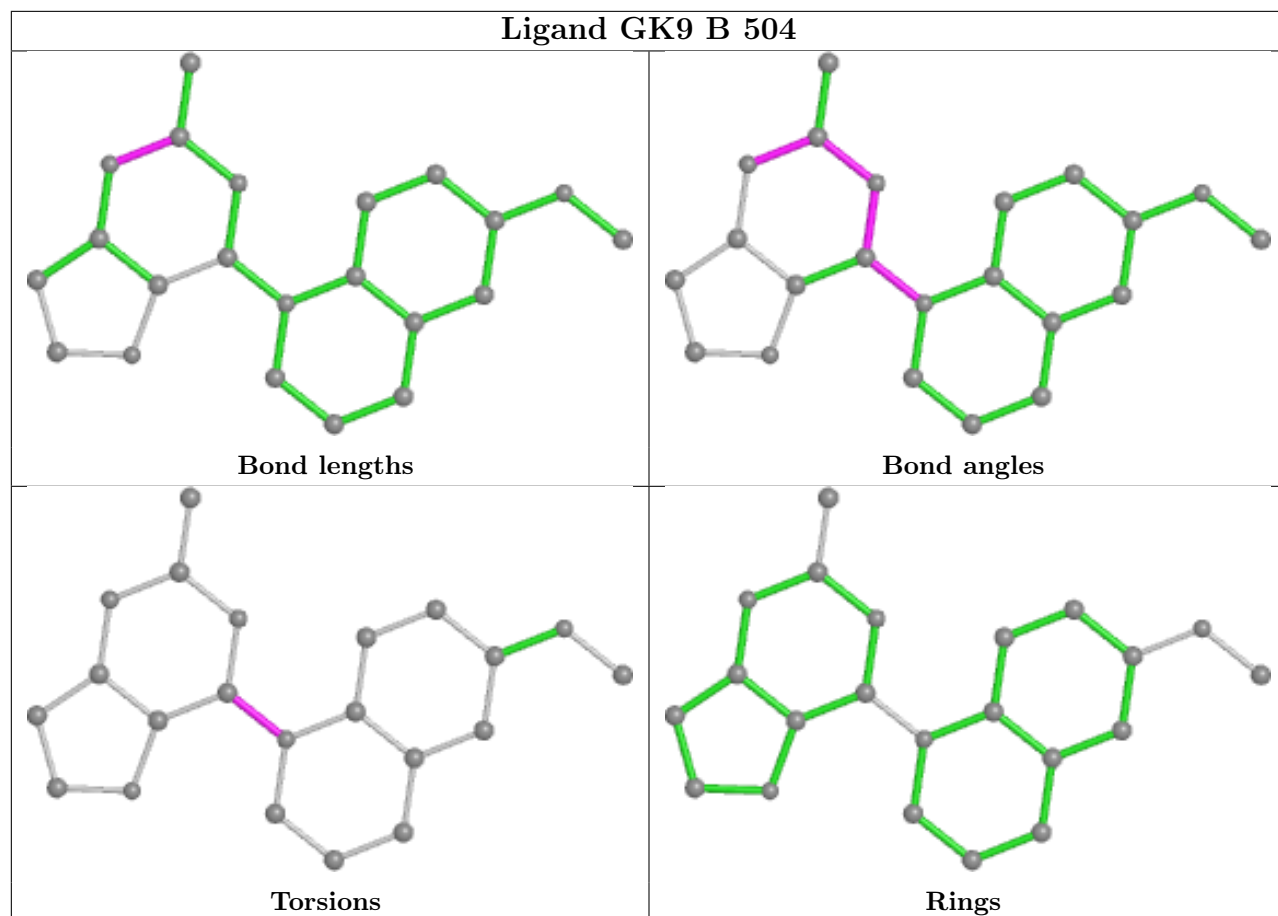

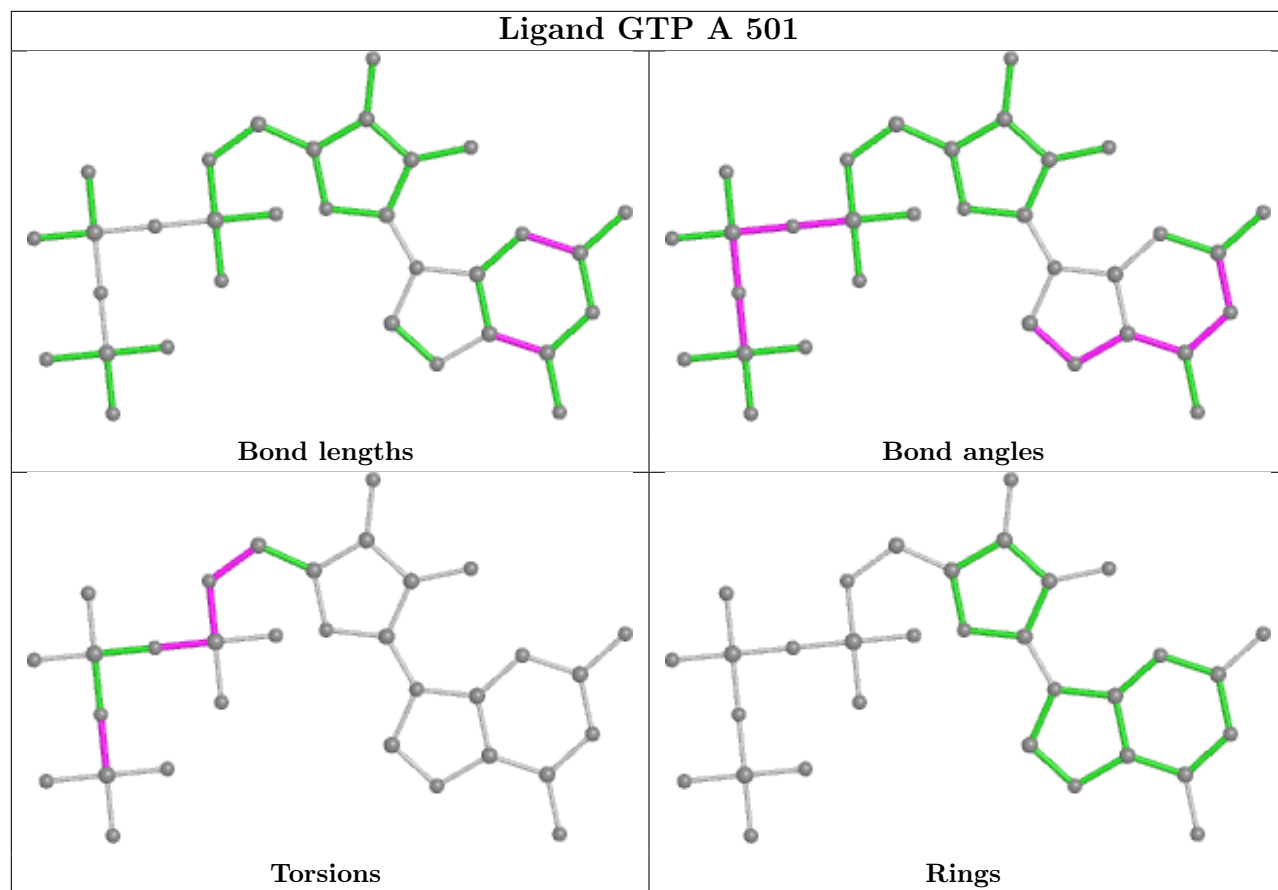

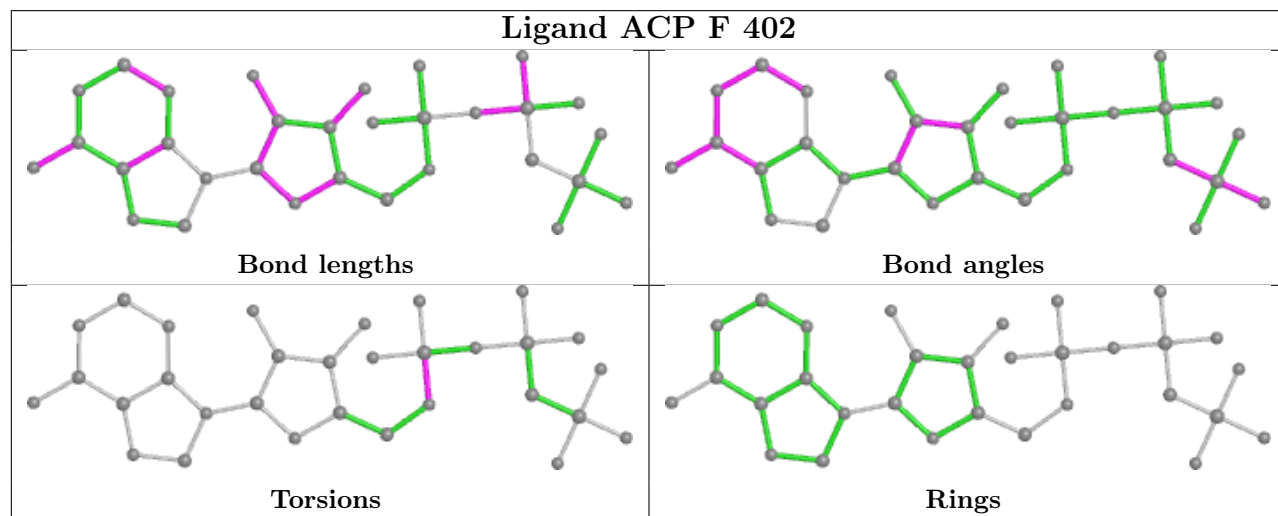
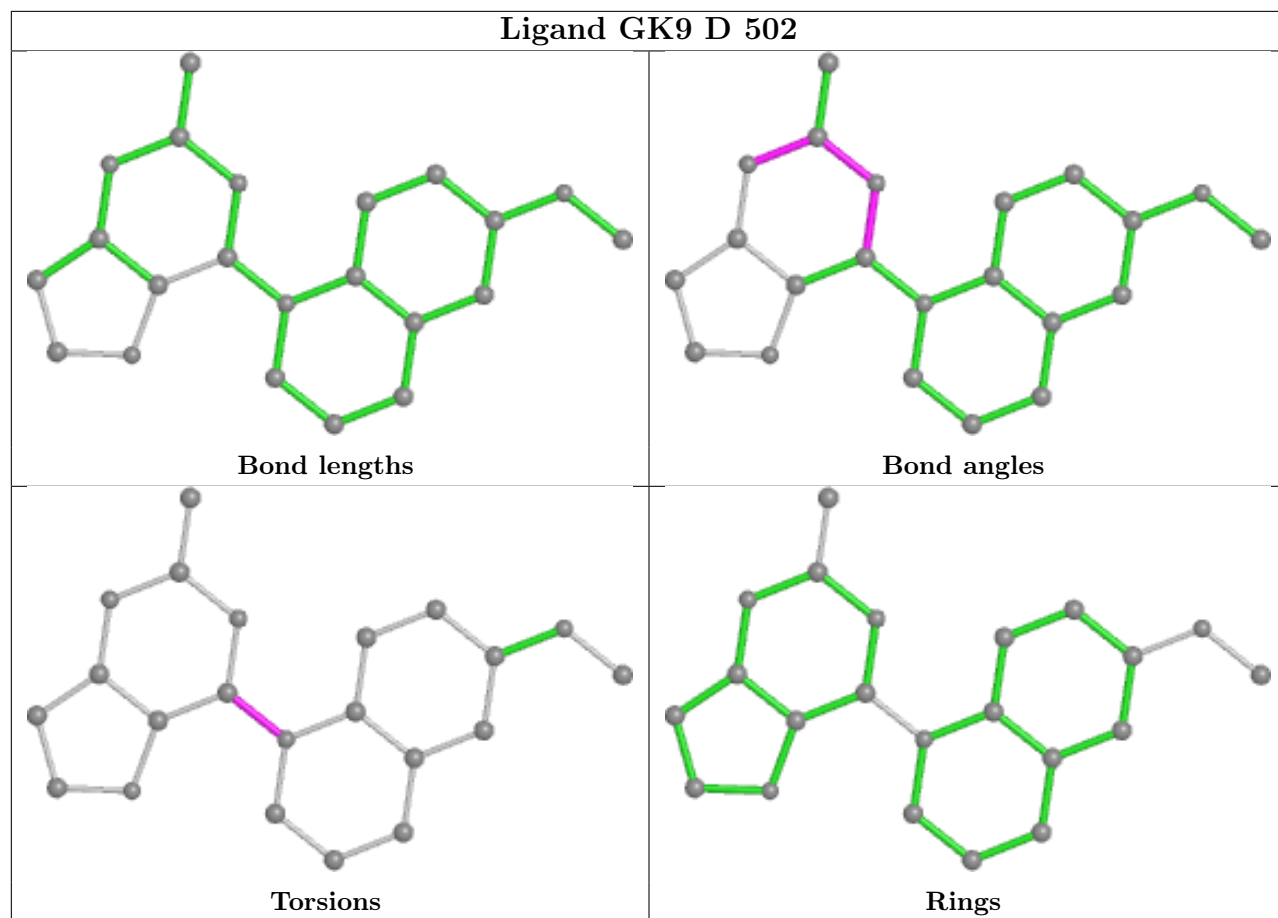

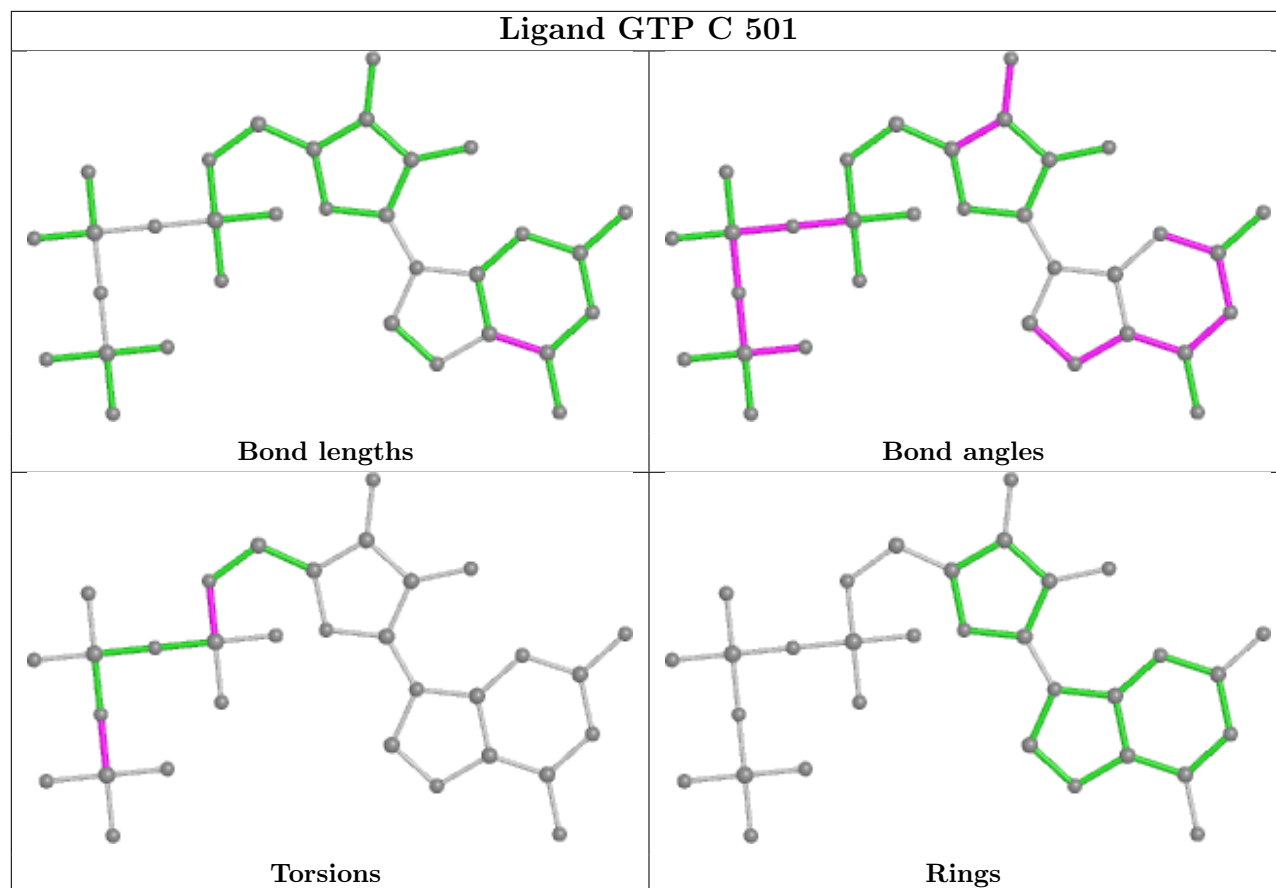

5.7 Other polymers [i](#)

There are no such residues in this entry.

5.8 Polymer linkage issues [i](#)

There are no chain breaks in this entry.

6 Fit of model and data

6.1 Protein, DNA and RNA chains

In the following table, the column labelled ‘#RSRZ> 2’ contains the number (and percentage) of RSRZ outliers, followed by percent RSRZ outliers for the chain as percentile scores relative to all X-ray entries and entries of similar resolution. The OWAB column contains the minimum, median, 95th percentile and maximum values of the occupancy-weighted average B-factor per residue. The column labelled ‘Q< 0.9’ lists the number of (and percentage) of residues with an average occupancy less than 0.9.

Mol	Chain	Analysed	<RSRZ>	#RSRZ>2	OWAB(Å ²)	Q<0.9
1	A	437/450 (97%)	-0.28	1 (0%) 95 96	22, 39, 71, 95	0
1	C	440/450 (97%)	-0.50	0 100 100	16, 28, 56, 83	0
2	B	428/445 (96%)	-0.24	11 (2%) 56 57	16, 36, 79, 115	0
2	D	421/445 (94%)	0.17	23 (5%) 25 24	25, 59, 97, 119	0
3	E	121/143 (84%)	0.13	8 (6%) 18 16	25, 53, 93, 118	0
4	F	332/384 (86%)	0.77	73 (21%) 0 0	29, 66, 128, 155	0
All	All	2179/2317 (94%)	-0.05	116 (5%) 26 25	16, 45, 98, 155	0

All (116) RSRZ outliers are listed below:

Mol	Chain	Res	Type	RSRZ
4	F	253	TYR	7.4
4	F	244	CYS	6.5
4	F	177	GLY	6.3
4	F	140	GLU	6.2
2	B	55	THR	5.7
4	F	136	ASN	5.5
4	F	142	ARG	5.2
4	F	100	ILE	5.2
4	F	232	ASN	5.0
2	B	279	GLN	5.0
4	F	233	PHE	4.7
3	E	141	GLU	4.5
4	F	182	ILE	4.5
4	F	132	LEU	4.5
4	F	173	ILE	4.5
4	F	101	TYR	4.4
4	F	225	SER	4.3
4	F	194	PRO	4.3
4	F	148	ILE	4.2

Continued on next page...

Continued from previous page...

Mol	Chain	Res	Type	RSRZ
4	F	254	GLY	4.1
4	F	259	GLY	4.0
4	F	257	GLU	4.0
4	F	176	GLN	4.0
4	F	162	ILE	4.0
2	D	55	THR	3.9
4	F	178	GLN	3.8
4	F	130	VAL	3.8
4	F	175	GLU	3.8
4	F	256	TYR	3.8
4	F	172	PHE	3.8
4	F	179	VAL	3.8
2	D	54	ALA	3.8
4	F	149	ALA	3.7
4	F	237	THR	3.7
2	B	277	GLY	3.7
3	E	48	GLU	3.7
4	F	146	VAL	3.6
4	F	181	VAL	3.5
2	D	390	ARG	3.4
4	F	241	THR	3.3
3	E	139	LEU	3.3
4	F	223	THR	3.3
4	F	163	SER	3.3
4	F	240	LEU	3.3
4	F	133	ALA	3.2
4	F	139	ARG	3.1
2	D	245	GLN	3.1
3	E	27	PRO	3.1
4	F	131	PHE	3.1
2	D	431	ASP	3.1
4	F	103	THR	3.1
2	D	216	LYS	3.1
4	F	372	THR	3.0
2	B	56	GLY	3.0
4	F	20	LEU	3.0
4	F	243	HIS	3.0
4	F	192	LEU	3.0
4	F	197	ARG	2.9
2	D	37	HIS	2.9
2	B	428	ALA	2.9
2	B	57	ASN	2.9

Continued on next page...

Continued from previous page...

Mol	Chain	Res	Type	RSRZ
4	F	239	HIS	2.9
4	F	99	VAL	2.8
2	D	217	LEU	2.8
4	F	252	ASN	2.8
3	E	28	SER	2.7
2	D	391	ARG	2.7
4	F	102	PRO	2.7
4	F	224	SER	2.7
4	F	165	GLU	2.7
2	D	406	MET	2.7
4	F	234	GLN	2.6
2	D	57	ASN	2.6
1	A	163	LYS	2.6
4	F	128	ARG	2.6
4	F	361	LEU	2.6
2	D	73	MET	2.5
4	F	255	ARG	2.5
4	F	147	TRP	2.5
4	F	135	TYR	2.5
4	F	258	GLU	2.5
2	D	218	THR	2.5
4	F	236	LYS	2.5
4	F	238	CYS	2.4
4	F	25	GLY	2.4
2	D	53	GLU	2.4
2	D	219	THR	2.4
4	F	169	LEU	2.4
4	F	138	ARG	2.4
2	B	33	THR	2.4
2	D	92	PHE	2.4
4	F	242	ASN	2.4
4	F	174	ASP	2.3
2	B	282	ARG	2.3
4	F	263	PHE	2.3
3	E	44	ASP	2.3
2	B	37	HIS	2.3
2	D	395	LEU	2.3
3	E	138	GLU	2.3
4	F	180	HIS	2.2
2	D	1	MET	2.2
2	D	405	GLU	2.2
4	F	134	ALA	2.2

Continued on next page...

Continued from previous page...

Mol	Chain	Res	Type	RSRZ
4	F	171	ASP	2.2
4	F	195	GLY	2.2
2	D	389	PHE	2.2
2	B	58	LYS	2.1
4	F	247	LYS	2.1
4	F	129	GLU	2.1
2	B	280	GLN	2.0
2	D	392	LYS	2.0
4	F	341	LYS	2.0
3	E	136	ASN	2.0
2	D	83	GLN	2.0
2	D	247	ASN	2.0
4	F	143	GLU	2.0

6.2 Non-standard residues in protein, DNA, RNA chains [i](#)

There are no non-standard protein/DNA/RNA residues in this entry.

6.3 Carbohydrates [i](#)

There are no monosaccharides in this entry.

6.4 Ligands [i](#)

In the following table, the Atoms column lists the number of modelled atoms in the group and the number defined in the chemical component dictionary. The B-factors column lists the minimum, median, 95th percentile and maximum values of B factors of atoms in the group. The column labelled 'Q< 0.9' lists the number of atoms with occupancy less than 0.9.

Mol	Type	Chain	Res	Atoms	RSCC	RSR	B-factors(Å ²)	Q<0.9
6	MG	F	401	1/1	0.87	0.21	88,88,88,88	0
9	MES	C	504	12/12	0.90	0.26	30,34,70,77	12
11	ACP	F	402	31/31	0.90	0.20	83,99,135,165	0
8	GDP	D	501	28/28	0.92	0.15	50,56,70,72	0
6	MG	B	505	1/1	0.94	0.41	37,37,37,37	0
7	CA	A	503	1/1	0.96	0.04	59,59,59,59	0
9	MES	B	502	12/12	0.97	0.14	32,39,56,58	0
10	GK9	B	504	22/22	0.97	0.14	24,30,36,49	0
9	MES	B	503	12/12	0.97	0.14	53,55,66,71	0
6	MG	C	502	1/1	0.98	0.18	40,40,40,40	0

Continued on next page...

Continued from previous page...

Mol	Type	Chain	Res	Atoms	RSCC	RSR	B-factors(\AA^2)	Q<0.9
10	GK9	D	502	22/22	0.98	0.12	25,31,46,72	0
7	CA	C	503	1/1	0.98	0.05	36,36,36,36	0
8	GDP	B	501	28/28	0.99	0.14	13,21,28,28	0
6	MG	A	502	1/1	0.99	0.16	23,23,23,23	0
5	GTP	A	501	32/32	0.99	0.21	19,22,38,41	0
5	GTP	C	501	32/32	0.99	0.14	20,22,30,33	0

The following is a graphical depiction of the model fit to experimental electron density of all instances of the Ligand of Interest. In addition, ligands with molecular weight > 250 and outliers as shown on the geometry validation Tables will also be included. Each fit is shown from different orientation to approximate a three-dimensional view.

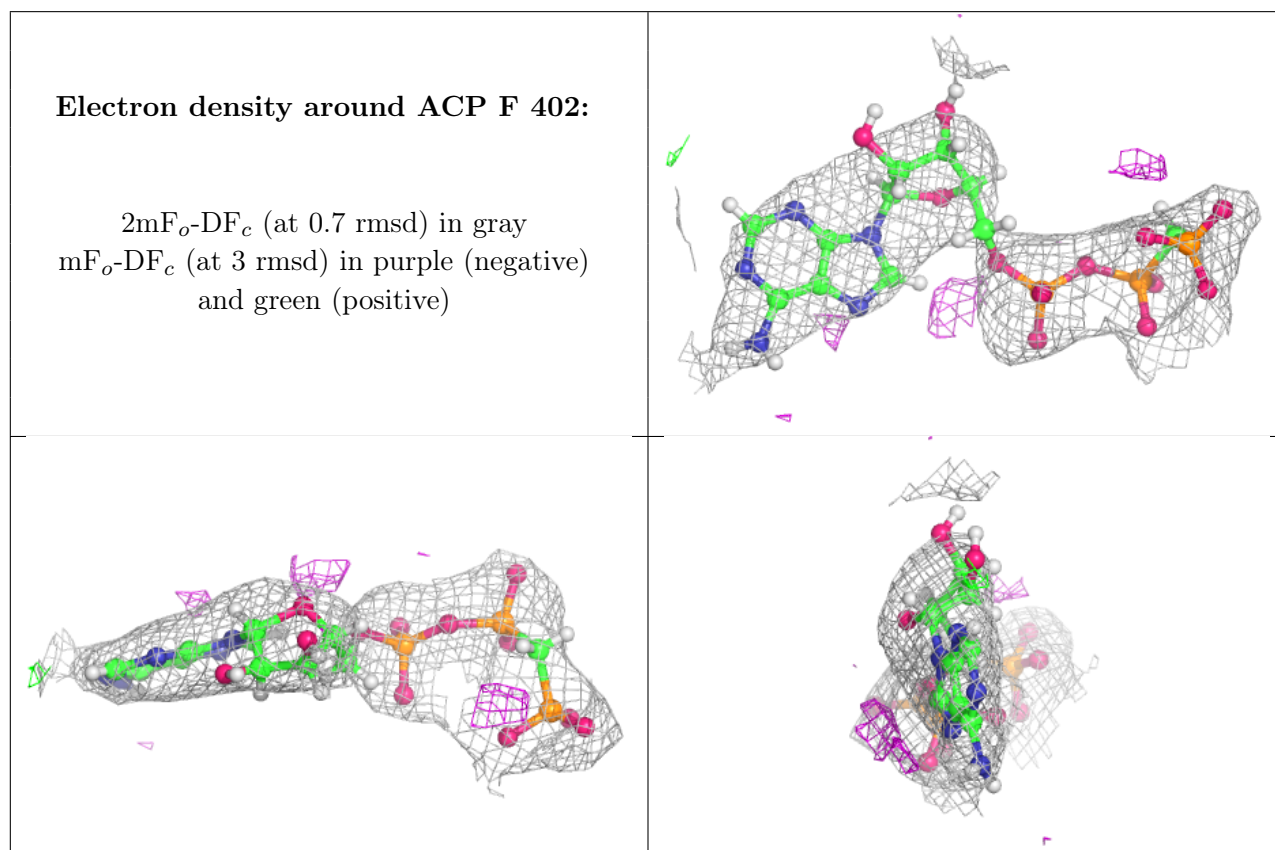

Electron density around GDP D 501:

$2mF_o-DF_c$ (at 0.7 rmsd) in gray
 mF_o-DF_c (at 3 rmsd) in purple (negative)
and green (positive)

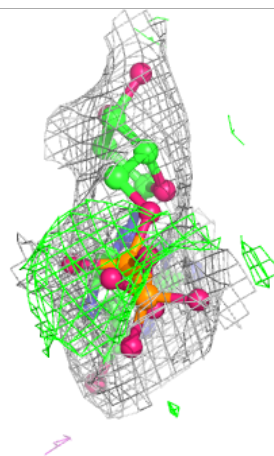
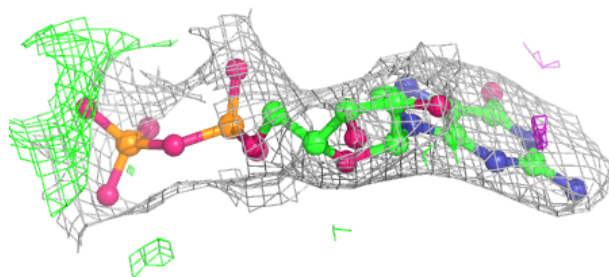
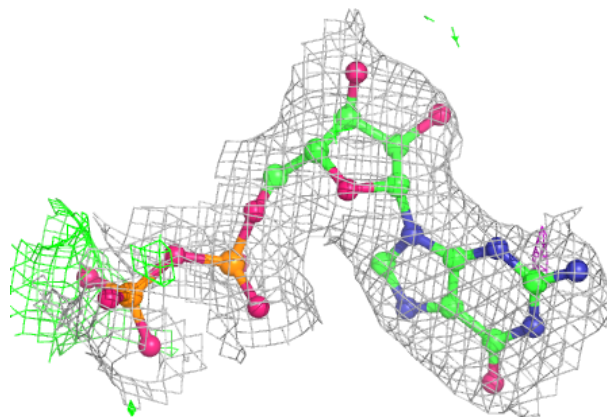

Electron density around GK9 B 504:

$2mF_o-DF_c$ (at 0.7 rmsd) in gray
 mF_o-DF_c (at 3 rmsd) in purple (negative)
and green (positive)

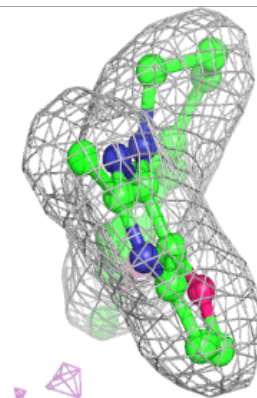
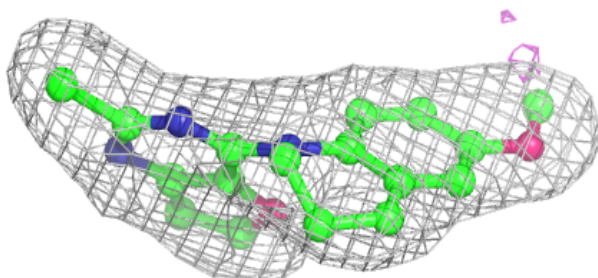
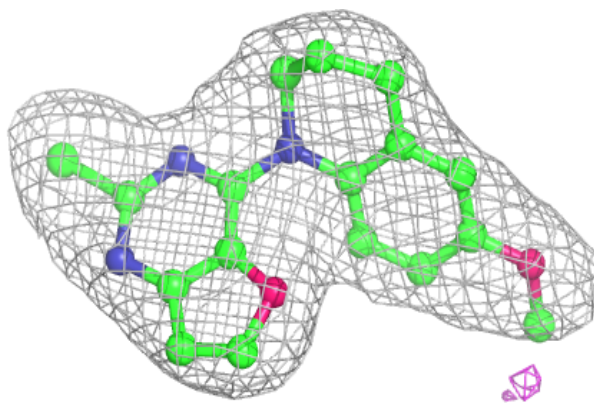
**Electron density around GK9 D 502:**

$2mF_o-DF_c$ (at 0.7 rmsd) in gray
 mF_o-DF_c (at 3 rmsd) in purple (negative)
and green (positive)

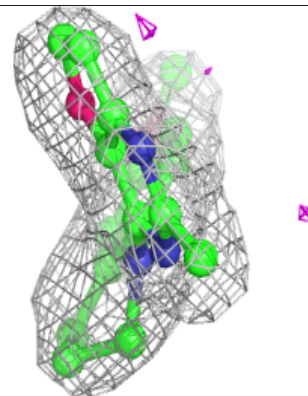
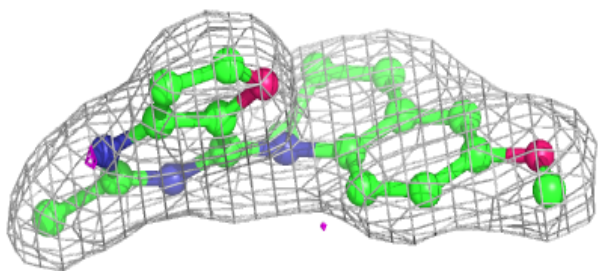
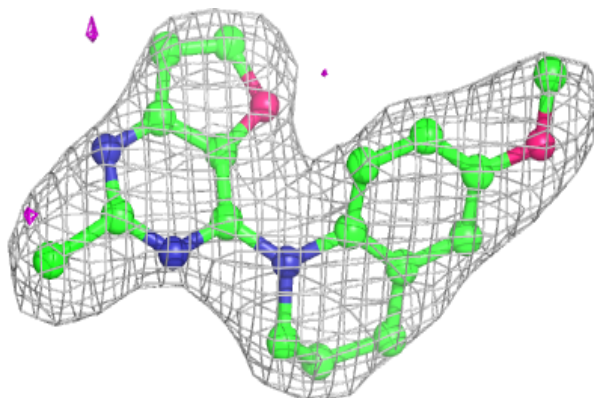

Electron density around GDP B 501:

$2mF_o-DF_c$ (at 0.7 rmsd) in gray
 mF_o-DF_c (at 3 rmsd) in purple (negative)
and green (positive)

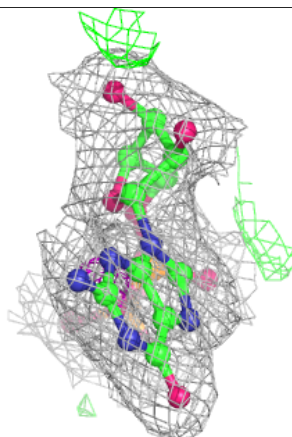
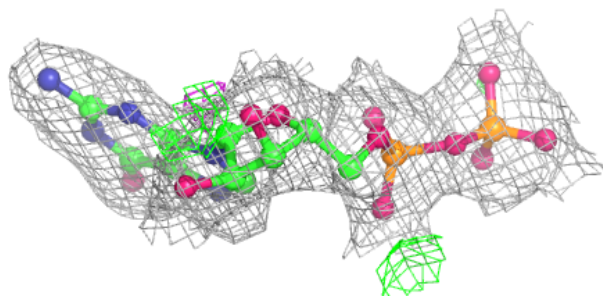
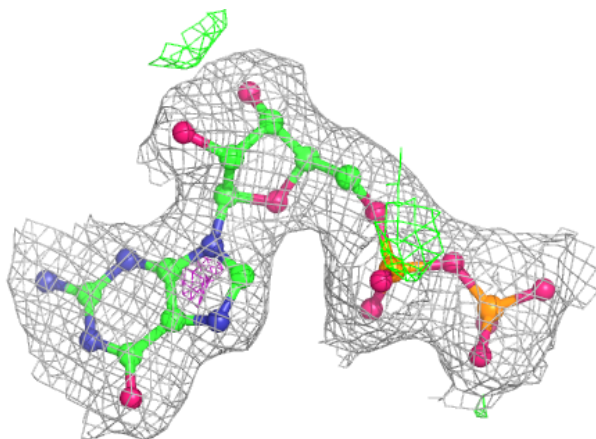
**Electron density around GTP A 501:**

$2mF_o-DF_c$ (at 0.7 rmsd) in gray
 mF_o-DF_c (at 3 rmsd) in purple (negative)
and green (positive)

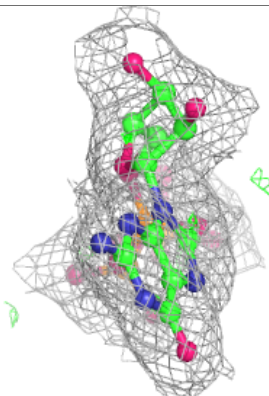
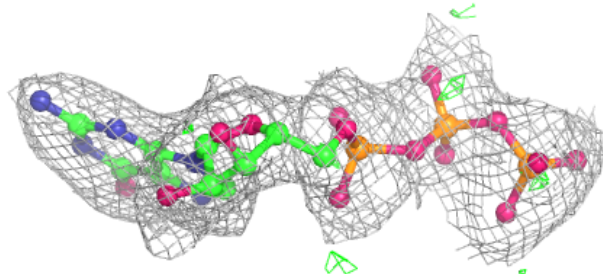
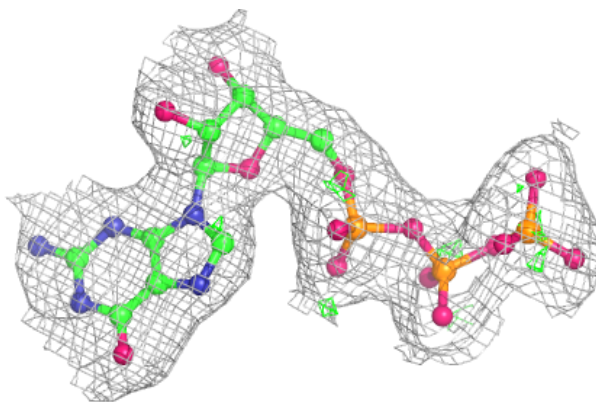

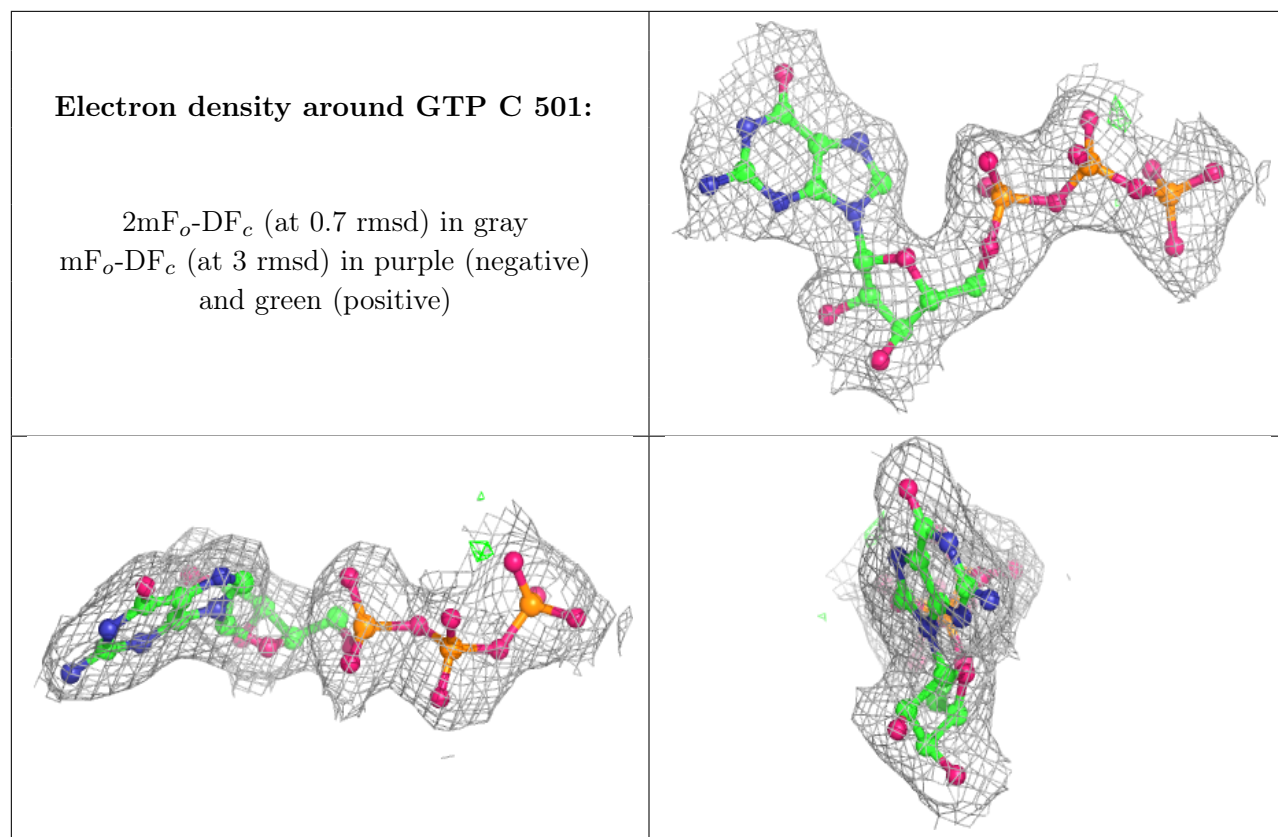

6.5 Other polymers [i](#)

There are no such residues in this entry.