



# Full wwPDB X-ray Structure Validation Report ⓘ

Sep 20, 2023 – 12:01 AM EDT

PDB ID : 5J1E  
Title : Crystal Structure of a Hydroxypyridone Carboxylic Acid Active-Site RNase H Inhibitor in Complex with HIV Reverse Transcriptase  
Authors : Kirby, K.A.; Sarafianos, S.G.  
Deposited on : 2016-03-29  
Resolution : 2.90 Å(reported)

This is a Full wwPDB X-ray Structure Validation Report for a publicly released PDB entry.

We welcome your comments at [validation@mail.wwpdb.org](mailto:validation@mail.wwpdb.org)

A user guide is available at

<https://www.wwpdb.org/validation/2017/XrayValidationReportHelp>

with specific help available everywhere you see the ⓘ symbol.

The types of validation reports are described at

<http://www.wwpdb.org/validation/2017/FAQs#types>.

---

The following versions of software and data (see [references ⓘ](#)) were used in the production of this report:

MolProbity : 4.02b-467  
Mogul : 1.8.5 (274361), CSD as541be (2020)  
Xtriage (Phenix) : 1.13  
EDS : 2.35.1  
buster-report : 1.1.7 (2018)  
Percentile statistics : 20191225.v01 (using entries in the PDB archive December 25th 2019)  
Refmac : 5.8.0158  
CCP4 : 7.0.044 (Gargrove)  
Ideal geometry (proteins) : Engh & Huber (2001)  
Ideal geometry (DNA, RNA) : Parkinson et al. (1996)  
Validation Pipeline (wwPDB-VP) : 2.35.1

# 1 Overall quality at a glance

The following experimental techniques were used to determine the structure:

*X-RAY DIFFRACTION*

The reported resolution of this entry is 2.90 Å.

Percentile scores (ranging between 0-100) for global validation metrics of the entry are shown in the following graphic. The table shows the number of entries on which the scores are based.

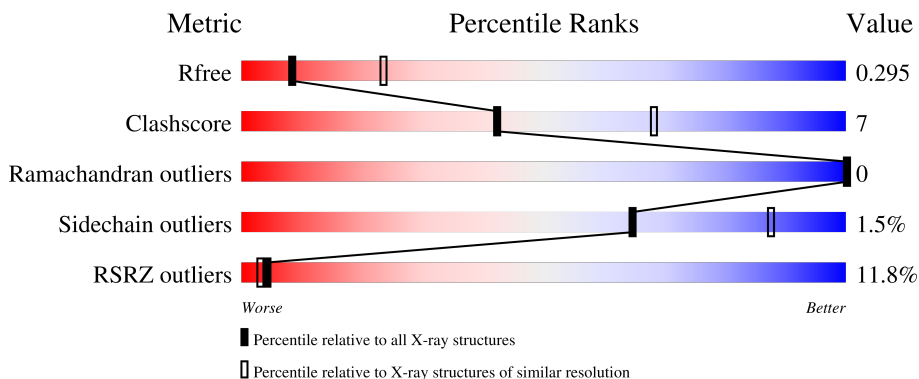

Metric	Whole archive (#Entries)	Similar resolution (#Entries, resolution range(Å))
$R_{free}$	130704	1957 (2.90-2.90)
Clashscore	141614	2172 (2.90-2.90)
Ramachandran outliers	138981	2115 (2.90-2.90)
Sidechain outliers	138945	2117 (2.90-2.90)
RSRZ outliers	127900	1906 (2.90-2.90)

The table below summarises the geometric issues observed across the polymeric chains and their fit to the electron density. The red, orange, yellow and green segments of the lower bar indicate the fraction of residues that contain outliers for  $\geq 3$ , 2, 1 and 0 types of geometric quality criteria respectively. A grey segment represents the fraction of residues that are not modelled. The numeric value for each fraction is indicated below the corresponding segment, with a dot representing fractions  $\leq 5\%$ . The upper red bar (where present) indicates the fraction of residues that have poor fit to the electron density. The numeric value is given above the bar.

Mol	Chain	Length	Quality of chain
1	A	557	 17% 73% 24% ..
1	C	557	 9% 82% 16% .
2	B	429	 11% 76% 19% 6%
2	D	429	 7% 74% 17% 8%

The following table lists non-polymeric compounds, carbohydrate monomers and non-standard

residues in protein, DNA, RNA chains that are outliers for geometric or electron-density-fit criteria:

Mol	Type	Chain	Res	Chirality	Geometry	Clashes	Electron density
4	6FT	C	603	-	-	-	X

## 2 Entry composition i

There are 5 unique types of molecules in this entry. The entry contains 15484 atoms, of which 0 are hydrogens and 0 are deuteriums.

In the tables below, the ZeroOcc column contains the number of atoms modelled with zero occupancy, the AltConf column contains the number of residues with at least one atom in alternate conformation and the Trace column contains the number of residues modelled with at most 2 atoms.

- Molecule 1 is a protein called HIV-1 REVERSE TRANSCRIPTASE P66 DOMAIN.

Mol	Chain	Residues	Atoms					ZeroOcc	AltConf	Trace
			Total	C	N	O	S			
1	A	541	Total	C	N	O	S	0	0	0
			4407	2855	730	815	7			
1	C	548	Total	C	N	O	S	0	0	0
			4463	2889	742	825	7			

There are 6 discrepancies between the modelled and reference sequences:

Chain	Residue	Modelled	Actual	Comment	Reference
A	-1	MET	-	initiating methionine	UNP P03366
A	0	VAL	-	expression tag	UNP P03366
A	280	SER	CYS	engineered mutation	UNP P03366
C	-1	MET	-	initiating methionine	UNP P03366
C	0	VAL	-	expression tag	UNP P03366
C	280	SER	CYS	engineered mutation	UNP P03366

- Molecule 2 is a protein called HIV-1 REVERSE TRANSCRIPTASE P51 DOMAIN.

Mol	Chain	Residues	Atoms					ZeroOcc	AltConf	Trace
			Total	C	N	O	S			
2	B	405	Total	C	N	O	S	0	0	0
			3341	2175	554	606	6			
2	D	393	Total	C	N	O	S	0	0	0
			3240	2114	532	589	5			

There are 4 discrepancies between the modelled and reference sequences:

Chain	Residue	Modelled	Actual	Comment	Reference
B	0	GLY	-	expression tag	UNP P03366
B	280	SER	CYS	engineered mutation	UNP P03366
D	0	GLY	-	expression tag	UNP P03366
D	280	SER	CYS	engineered mutation	UNP P03366

- Molecule 3 is MAGNESIUM ION (three-letter code: MG) (formula: Mg).

Mol	Chain	Residues	Atoms	ZeroOcc	AltConf
3	A	1	Total Mg 1 1	0	0
3	C	2	Total Mg 2 2	0	0

- Molecule 4 is 5-hydroxy-4-oxo-1-[(4'-sulfamoyl[1,1'-biphenyl]-4-yl)methyl]-1,4-dihydropyridine-3-carboxylic acid (three-letter code: 6FT) (formula: C<sub>19</sub>H<sub>16</sub>N<sub>2</sub>O<sub>6</sub>S).

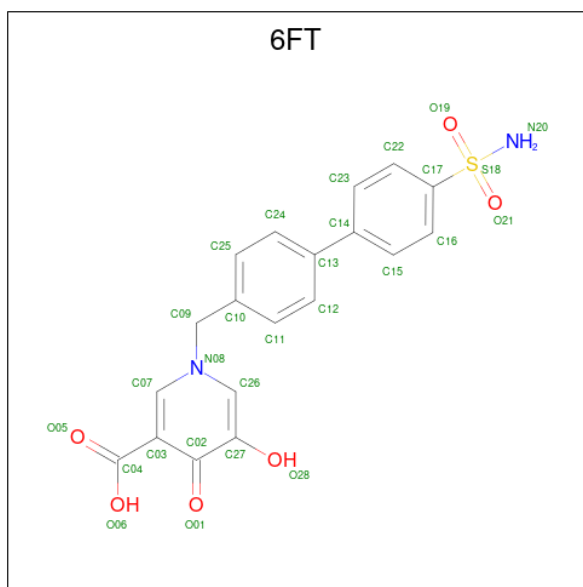

Mol	Chain	Residues	Atoms	ZeroOcc	AltConf
4	C	1	Total C N O S 28 19 2 6 1	0	0

- Molecule 5 is water.

Mol	Chain	Residues	Atoms	ZeroOcc	AltConf
5	B	1	Total O 1 1	0	0
5	D	1	Total O 1 1	0	0

### 3 Residue-property plots

These plots are drawn for all protein, RNA, DNA and oligosaccharide chains in the entry. The first graphic for a chain summarises the proportions of the various outlier classes displayed in the second graphic. The second graphic shows the sequence view annotated by issues in geometry and electron density. Residues are color-coded according to the number of geometric quality criteria for which they contain at least one outlier: green = 0, yellow = 1, orange = 2 and red = 3 or more. A red dot above a residue indicates a poor fit to the electron density ( $RSRZ > 2$ ). Stretches of 2 or more consecutive residues without any outlier are shown as a green connector. Residues present in the sample, but not in the model, are shown in grey.

#### • Molecule 1: HIV-1 REVERSE TRANSCRIPTASE P66 DOMAIN

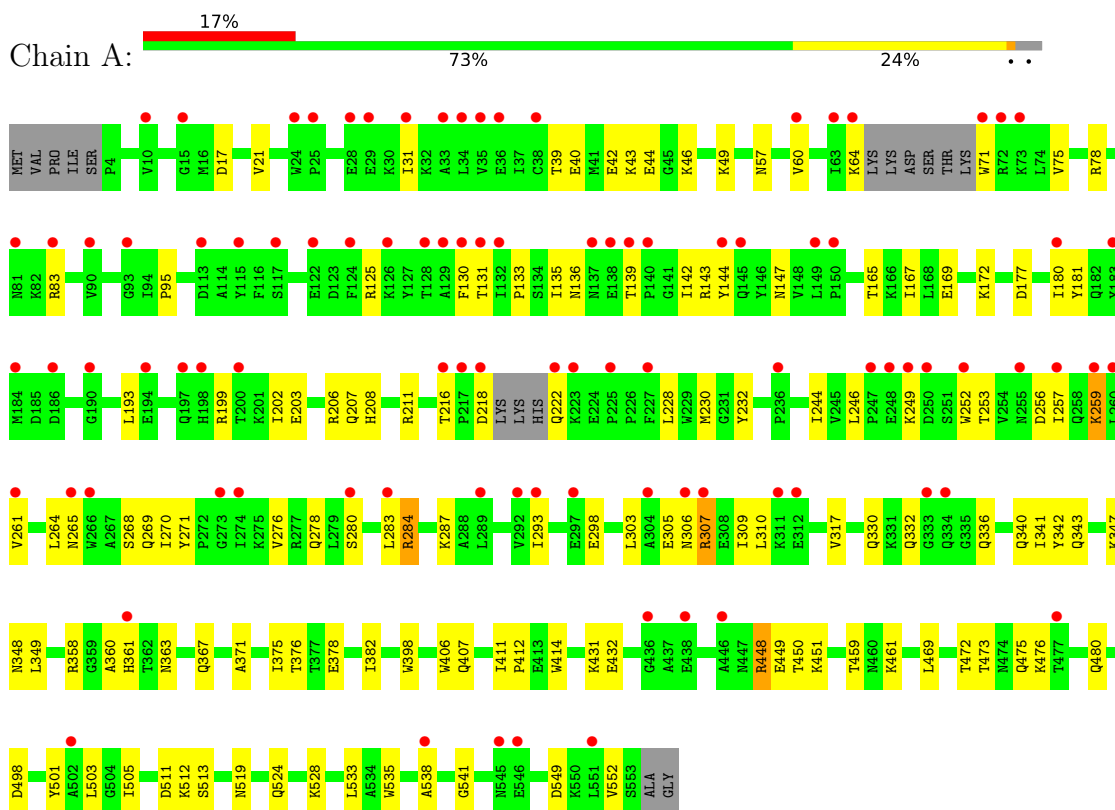

#### • Molecule 1: HIV-1 REVERSE TRANSCRIPTASE P66 DOMAIN

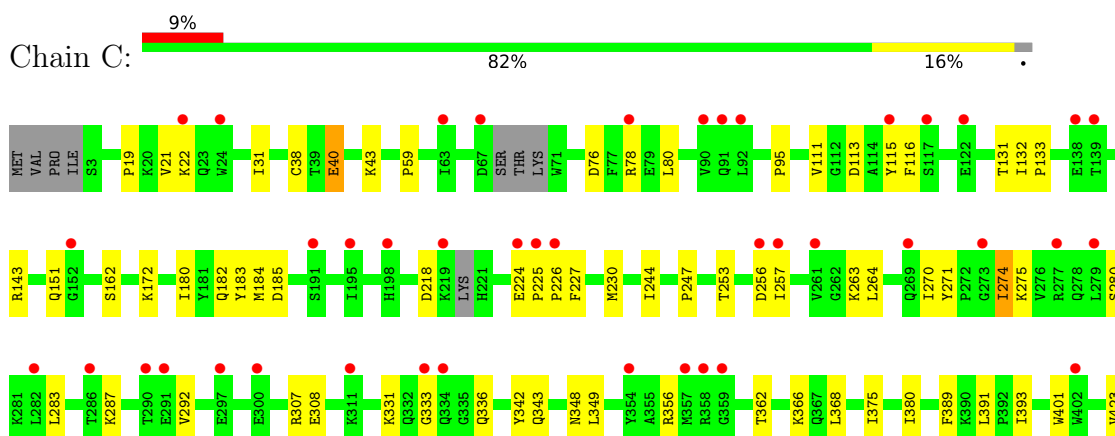

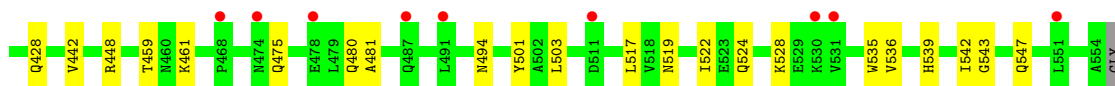

● Molecule 2: HIV-1 REVERSE TRANSCRIPTASE P51 DOMAIN

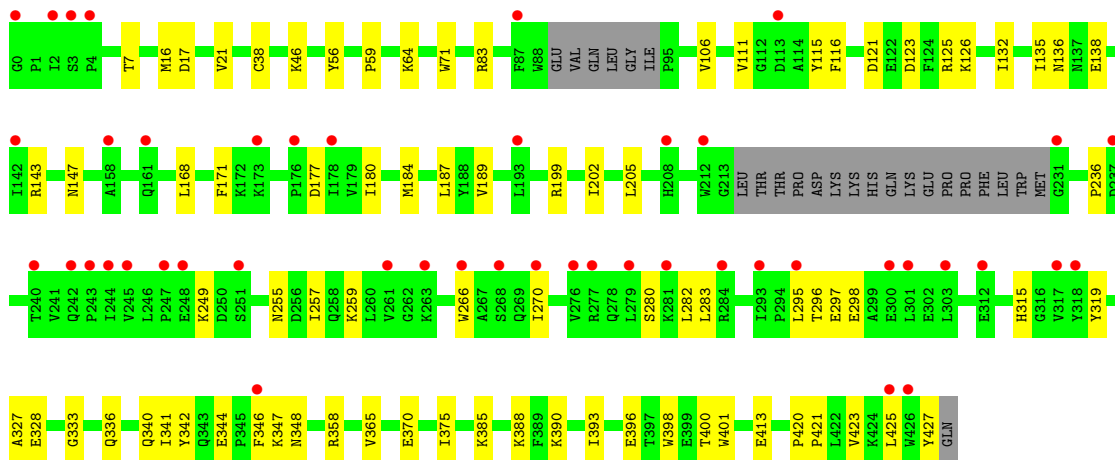
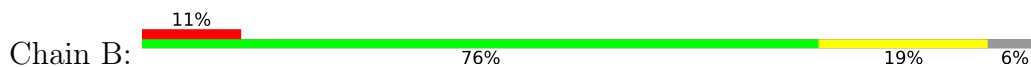

● Molecule 2: HIV-1 REVERSE TRANSCRIPTASE P51 DOMAIN

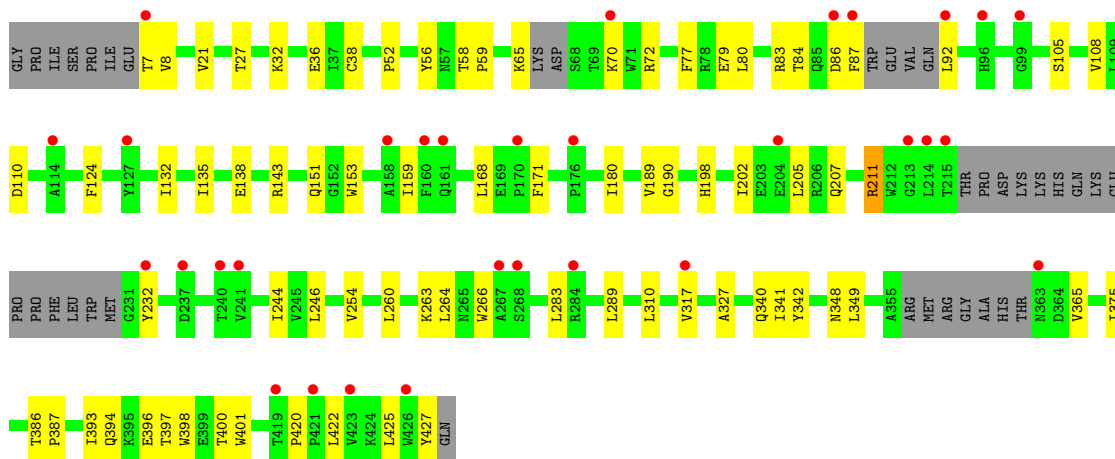
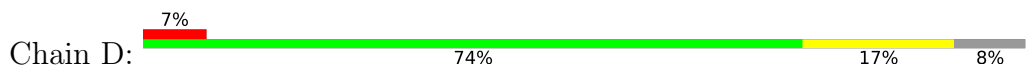

## 4 Data and refinement statistics i

Property	Value	Source
Space group	P 1	Depositor
Cell constants a, b, c, $\alpha$ , $\beta$ , $\gamma$	69.07Å 89.31Å 108.22Å 105.47° 92.69° 110.80°	Depositor
Resolution (Å)	63.77 – 2.90 63.77 – 2.90	Depositor EDS
% Data completeness (in resolution range)	97.8 (63.77-2.90) 97.9 (63.77-2.90)	Depositor EDS
$R_{merge}$	0.09	Depositor
$R_{sym}$	(Not available)	Depositor
$\langle I/\sigma(I) \rangle$ <sup>1</sup>	2.92 (at 2.91Å)	Xtrriage
Refinement program	PHENIX (1.10.1_2155)	Depositor
R, $R_{free}$	0.254 , 0.294 0.254 , 0.295	Depositor DCC
$R_{free}$ test set	2495 reflections (5.00%)	wwPDB-VP
Wilson B-factor (Å <sup>2</sup> )	61.9	Xtrriage
Anisotropy	0.293	Xtrriage
Bulk solvent $k_{sol}$ (e/Å <sup>3</sup> ), $B_{sol}$ (Å <sup>2</sup> )	0.31 , 30.5	EDS
L-test for twinning <sup>2</sup>	$\langle  L  \rangle = 0.50$ , $\langle L^2 \rangle = 0.34$	Xtrriage
Estimated twinning fraction	0.014 for h,-h-k,-l	Xtrriage
$F_o, F_c$ correlation	0.90	EDS
Total number of atoms	15484	wwPDB-VP
Average B, all atoms (Å <sup>2</sup> )	74.0	wwPDB-VP

Xtrriage's analysis on translational NCS is as follows: *The largest off-origin peak in the Patterson function is 4.19% of the height of the origin peak. No significant pseudotranslation is detected.*

<sup>1</sup>Intensities estimated from amplitudes.

<sup>2</sup>Theoretical values of  $\langle |L| \rangle$ ,  $\langle L^2 \rangle$  for acentric reflections are 0.5, 0.333 respectively for untwinned datasets, and 0.375, 0.2 for perfectly twinned datasets.



## 5 Model quality [i](#)

### 5.1 Standard geometry [i](#)

Bond lengths and bond angles in the following residue types are not validated in this section: MG, 6FT

The Z score for a bond length (or angle) is the number of standard deviations the observed value is removed from the expected value. A bond length (or angle) with  $|Z| > 5$  is considered an outlier worth inspection. RMSZ is the root-mean-square of all Z scores of the bond lengths (or angles).

Mol	Chain	Bond lengths		Bond angles	
		RMSZ	# Z  >5	RMSZ	# Z  >5
1	A	0.25	0/4521	0.46	0/6143
1	C	0.24	0/4578	0.44	0/6218
2	B	0.25	0/3437	0.42	0/4668
2	D	0.24	0/3329	0.43	0/4520
All	All	0.25	0/15865	0.44	0/21549

Chiral center outliers are detected by calculating the chiral volume of a chiral center and verifying if the center is modelled as a planar moiety or with the opposite hand. A planarity outlier is detected by checking planarity of atoms in a peptide group, atoms in a mainchain group or atoms of a sidechain that are expected to be planar.

Mol	Chain	#Chirality outliers	#Planarity outliers
1	A	0	1

There are no bond length outliers.

There are no bond angle outliers.

There are no chirality outliers.

All (1) planarity outliers are listed below:

Mol	Chain	Res	Type	Group
1	A	136	ASN	Peptide

### 5.2 Too-close contacts [i](#)

In the following table, the Non-H and H(model) columns list the number of non-hydrogen atoms and hydrogen atoms in the chain respectively. The H(added) column lists the number of hydrogen atoms added and optimized by MolProbity. The Clashes column lists the number of clashes within the asymmetric unit, whereas Symm-Clashes lists symmetry-related clashes.

Mol	Chain	Non-H	H(model)	H(added)	Clashes	Symm-Clashes
1	A	4407	0	4450	86	1
1	C	4463	0	4509	52	1
2	B	3341	0	3373	46	0
2	D	3240	0	3276	42	0
3	A	1	0	0	0	0
3	C	2	0	0	0	0
4	C	28	0	0	1	0
5	B	1	0	0	0	0
5	D	1	0	0	0	0
All	All	15484	0	15608	215	1

The all-atom clashscore is defined as the number of clashes found per 1000 atoms (including hydrogen atoms). The all-atom clashscore for this structure is 7.

All (215) close contacts within the same asymmetric unit are listed below, sorted by their clash magnitude.

Atom-1	Atom-2	Interatomic distance (Å)	Clash overlap (Å)
2:D:84:THR:HG21	2:D:153:TRP:HE1	1.42	0.84
1:C:59:PRO:HG2	1:C:76:ASP:HB3	1.61	0.82
1:A:83:ARG:NH2	1:C:308:GLU:OE1	2.16	0.79
2:B:270:ILE:HG12	2:B:346:PHE:HB3	1.67	0.76
1:A:246:LEU:HD21	1:A:310:LEU:HD12	1.69	0.73
2:D:246:LEU:HD11	2:D:264:LEU:HD21	1.71	0.72
1:C:459:THR:HG22	1:C:461:LYS:H	1.54	0.70
2:B:180:ILE:HG12	2:B:189:VAL:HG12	1.72	0.69
1:A:358:ARG:HG2	1:A:360:ALA:H	1.57	0.68
1:A:135:ILE:O	1:A:139:THR:OG1	2.11	0.68
1:A:206:ARG:NH1	1:A:216:THR:O	2.27	0.65
1:A:459:THR:HG22	1:A:461:LYS:H	1.62	0.64
2:D:180:ILE:HG12	2:D:189:VAL:HG12	1.79	0.64
1:A:167:ILE:O	1:A:208:HIS:NE2	2.25	0.64
1:C:21:VAL:HB	1:C:59:PRO:HD3	1.81	0.63
1:C:224:GLU:HG2	1:C:226:PRO:HD2	1.80	0.63
2:B:135:ILE:O	2:B:138:GLU:HG2	1.99	0.63
1:A:83:ARG:HH22	1:C:308:GLU:CD	2.03	0.62
1:A:228:LEU:HA	1:A:232:TYR:O	2.00	0.62
1:A:31:ILE:HG12	1:A:133:PRO:HG2	1.81	0.61
1:C:247:PRO:O	1:C:307:ARG:NH2	2.34	0.61
2:D:422:LEU:HG	2:D:425:LEU:HD12	1.83	0.60
1:A:472:THR:HA	1:A:476:LYS:HD2	1.82	0.60
2:B:168:LEU:HD22	2:B:205:LEU:HD11	1.84	0.60
1:C:356:ARG:HD2	1:C:362:THR:HG21	1.85	0.59

*Continued on next page...*

*Continued from previous page...*

Atom-1	Atom-2	Interatomic distance (Å)	Clash overlap (Å)
2:D:56:TYR:O	2:D:143:ARG:NH2	2.35	0.59
1:A:341:ILE:O	1:A:349:LEU:N	2.36	0.59
2:D:72:ARG:NH2	2:D:151:GLN:OE1	2.35	0.59
1:A:284:ARG:HH11	1:A:284:ARG:HB3	1.68	0.58
2:B:266:TRP:CE2	2:B:425:LEU:HD13	2.38	0.58
2:B:115:TYR:OH	2:B:184:MET:O	2.19	0.58
1:C:503:LEU:HD22	1:C:535:TRP:HB2	1.86	0.58
1:A:503:LEU:HD13	1:A:535:TRP:HB2	1.85	0.58
1:A:64:LYS:HB2	1:A:71:TRP:HA	1.86	0.57
1:A:342:TYR:HB3	1:A:348:ASN:HA	1.87	0.57
1:A:60:VAL:HG22	1:A:75:VAL:HG13	1.86	0.57
2:D:87:PHE:HB3	2:D:92:LEU:HB3	1.87	0.56
1:C:244:ILE:HG23	1:C:263:LYS:HE2	1.87	0.56
1:C:480:GLN:HG2	1:C:517:LEU:HD11	1.87	0.56
1:A:95:PRO:HB2	1:A:230:MET:HE1	1.88	0.56
1:A:524:GLN:O	1:A:528:LYS:HG2	2.04	0.56
2:D:79:GLU:HG3	2:D:83:ARG:HE	1.71	0.56
2:D:394:GLN:HB3	2:D:397:THR:HG22	1.87	0.56
1:A:317:VAL:HG23	1:A:349:LEU:HD23	1.87	0.56
1:C:78:ARG:NH2	1:C:287:LYS:O	2.31	0.55
2:B:125:ARG:HD3	2:B:147:ASN:HD22	1.71	0.54
2:D:168:LEU:HD22	2:D:205:LEU:HD11	1.88	0.54
2:D:254:VAL:HG13	2:D:283:LEU:HD22	1.89	0.54
1:C:368:LEU:HD11	1:C:391:LEU:HD22	1.90	0.54
1:A:303:LEU:O	1:A:307:ARG:HB3	2.08	0.54
1:A:181:TYR:CD1	2:B:138:GLU:HB3	2.43	0.54
1:A:261:VAL:O	1:A:265:ASN:ND2	2.41	0.53
2:B:64:LYS:HE3	2:B:71:TRP:CE2	2.43	0.53
2:D:365:VAL:HG11	2:D:401:TRP:HB2	1.91	0.53
1:C:31:ILE:HG12	1:C:133:PRO:HG2	1.90	0.53
1:C:475:GLN:HB3	1:C:501:TYR:CE2	2.44	0.53
1:A:268:SER:OG	1:A:269:GLN:OE1	2.24	0.52
1:A:78:ARG:NH2	1:A:287:LYS:O	2.42	0.52
1:C:270:ILE:HG23	1:C:271:TYR:HD1	1.73	0.52
2:B:365:VAL:HG11	2:B:401:TRP:HB2	1.91	0.52
2:B:106:VAL:HG12	2:B:236:PRO:HD3	1.91	0.52
1:A:330:GLN:NE2	1:A:340:GLN:OE1	2.32	0.52
1:C:442:VAL:HB	1:C:481:ALA:HB1	1.91	0.51
1:A:259:LYS:N	1:A:259:LYS:HD2	2.25	0.51
1:C:375:ILE:HD11	1:C:389:PHE:HE1	1.75	0.51
1:A:199:ARG:HA	1:A:202:ILE:HD12	1.91	0.51

*Continued on next page...*

*Continued from previous page...*

Atom-1	Atom-2	Interatomic distance (Å)	Clash overlap (Å)
2:B:327:ALA:HA	2:B:340:GLN:O	2.11	0.51
1:C:333:GLY:H	1:C:336:GLN:HB2	1.75	0.51
1:A:244:ILE:HB	1:A:310:LEU:HD13	1.92	0.50
2:B:111:VAL:HG11	2:B:187:LEU:HD12	1.93	0.50
2:D:246:LEU:HD13	2:D:260:LEU:HD11	1.93	0.50
2:B:328:GLU:HG2	2:B:390:LYS:HB2	1.94	0.49
2:B:315:HIS:O	2:B:347:LYS:NZ	2.39	0.49
2:D:21:VAL:HB	2:D:59:PRO:HD3	1.94	0.49
1:A:431:LYS:HG3	1:A:432:GLU:HG2	1.94	0.49
2:B:121:ASP:O	2:B:125:ARG:HG3	2.12	0.49
1:A:469:LEU:HD11	1:A:480:GLN:HG2	1.94	0.49
2:B:257:ILE:HB	2:B:283:LEU:HD21	1.95	0.49
1:C:393:ILE:HB	1:C:423:VAL:HB	1.94	0.49
1:A:203:GLU:O	1:A:207:GLN:HG2	2.12	0.49
2:B:341:ILE:HD11	2:B:375:ILE:HG23	1.95	0.49
1:C:343:GLN:HG3	1:C:349:LEU:HD11	1.94	0.49
1:A:130:PHE:CZ	1:A:144:TYR:HB2	2.48	0.49
2:B:255:ASN:O	2:B:259:LYS:HG2	2.13	0.48
1:A:549:ASP:HA	1:A:552:VAL:HG22	1.95	0.48
1:A:270:ILE:HG23	1:A:271:TYR:HD1	1.77	0.48
2:B:358:ARG:HE	2:B:370:GLU:HB2	1.79	0.48
1:A:317:VAL:HG21	1:A:347:LYS:HG2	1.95	0.48
1:C:183:TYR:HD1	1:C:184:MET:HG2	1.78	0.48
2:D:84:THR:HG22	2:D:124:PHE:HZ	1.79	0.48
1:A:44:GLU:HB3	1:A:46:LYS:HE3	1.94	0.48
1:A:284:ARG:HB3	1:A:284:ARG:NH1	2.28	0.48
2:B:333:GLY:O	2:B:336:GLN:HG2	2.14	0.48
1:A:249:LYS:NZ	1:A:256:ASP:OD2	2.47	0.48
2:D:396:GLU:O	2:D:400:THR:OG1	2.20	0.48
1:A:280:SER:HA	1:A:283:LEU:HD13	1.96	0.48
1:A:343:GLN:HG3	1:A:349:LEU:HD11	1.95	0.48
2:D:135:ILE:O	2:D:138:GLU:HG3	2.14	0.48
2:B:21:VAL:HB	2:B:59:PRO:HD3	1.96	0.47
1:C:115:TYR:HD2	1:C:151:GLN:HA	1.79	0.47
2:D:32:LYS:HE2	2:D:36:GLU:OE2	2.15	0.47
1:A:222:GLN:OE1	1:A:228:LEU:N	2.44	0.47
1:A:473:THR:H	1:A:476:LYS:HB3	1.79	0.47
2:B:342:TYR:HB3	2:B:348:ASN:HA	1.97	0.47
1:C:524:GLN:O	1:C:528:LYS:HG2	2.16	0.46
1:A:39:THR:O	1:A:43:LYS:HG3	2.15	0.46
1:A:44:GLU:HB2	1:A:46:LYS:HG2	1.97	0.46

*Continued on next page...*

*Continued from previous page...*

Atom-1	Atom-2	Interatomic distance (Å)	Clash overlap (Å)
1:A:172:LYS:HD3	1:A:180:ILE:HB	1.97	0.46
2:D:266:TRP:CG	2:D:425:LEU:HD13	2.50	0.46
1:A:60:VAL:HG21	1:A:130:PHE:CD2	2.50	0.46
1:C:536:VAL:HB	1:C:542:ILE:HD12	1.96	0.46
1:C:380:ILE:HD12	2:D:27:THR:HG22	1.98	0.46
2:D:327:ALA:HA	2:D:340:GLN:O	2.16	0.46
1:A:375:ILE:HA	1:A:378:GLU:HG2	1.98	0.46
1:A:40:GLU:HA	1:A:43:LYS:HD2	1.98	0.46
1:A:253:THR:HG23	1:A:256:ASP:H	1.80	0.46
1:C:131:THR:HG22	1:C:143:ARG:HD2	1.97	0.46
2:D:198:HIS:O	2:D:202:ILE:HG12	2.16	0.46
1:A:306:ASN:O	1:A:309:ILE:HG13	2.16	0.46
2:B:393:ILE:HD13	2:B:398:TRP:HB2	1.97	0.46
1:A:541:GLY:O	2:B:280:SER:HB2	2.17	0.45
1:A:125:ARG:HD3	1:A:147:ASN:HA	1.98	0.45
2:D:105:SER:O	2:D:190:GLY:HA2	2.16	0.45
1:A:131:THR:HG22	1:A:143:ARG:NE	2.32	0.45
1:A:332:GLN:HB2	1:A:336:GLN:HB2	1.98	0.45
1:A:498:ASP:HB2	1:A:538:ALA:HB2	1.97	0.45
2:D:420:PRO:HG2	2:D:422:LEU:HB2	1.98	0.45
2:B:396:GLU:O	2:B:400:THR:OG1	2.18	0.45
1:C:356:ARG:CD	1:C:362:THR:HG21	2.45	0.45
1:A:177:ASP:HB2	1:A:193:LEU:HD21	1.97	0.45
1:A:371:ALA:O	1:A:375:ILE:HG22	2.17	0.45
1:C:519:ASN:HA	1:C:522:ILE:HD12	1.99	0.45
1:A:165:THR:O	1:A:169:GLU:HG2	2.17	0.45
1:A:42:GLU:OE1	1:A:49:LYS:HE3	2.17	0.44
2:D:207:GLN:O	2:D:211:ARG:HD3	2.17	0.44
2:D:342:TYR:HB3	2:D:348:ASN:HA	1.99	0.44
1:A:257:ILE:O	1:A:261:VAL:HG13	2.16	0.44
2:D:317:VAL:HG22	2:D:349:LEU:HD23	1.98	0.44
1:A:376:THR:HG21	2:B:401:TRP:CH2	2.53	0.44
2:B:17:ASP:O	2:B:83:ARG:HD3	2.17	0.44
2:B:38:CYS:SG	2:B:132:ILE:HD11	2.57	0.44
2:B:297:GLU:H	2:B:297:GLU:CD	2.20	0.44
2:B:266:TRP:CE3	2:B:425:LEU:HD22	2.52	0.44
2:D:171:PHE:CG	2:D:205:LEU:HD13	2.53	0.44
1:A:207:GLN:O	1:A:211:ARG:HG3	2.17	0.44
2:B:199:ARG:O	2:B:202:ILE:HG13	2.18	0.44
1:C:22:LYS:H	1:C:22:LYS:HD2	1.82	0.44
1:C:543:GLY:O	1:C:547:GLN:HG2	2.18	0.44

*Continued on next page...*

*Continued from previous page...*

Atom-1	Atom-2	Interatomic distance (Å)	Clash overlap (Å)
1:A:412:PRO:O	1:A:414:TRP:HD1	2.00	0.44
2:B:56:TYR:O	2:B:143:ARG:NH2	2.50	0.43
1:C:494:ASN:HB3	2:D:289:LEU:HD12	2.00	0.43
1:C:539:HIS:HB2	4:C:603:6FT:C12	2.49	0.43
1:C:95:PRO:HB2	1:C:230:MET:HE1	2.01	0.43
1:C:264:LEU:HD22	1:C:274:ILE:HD11	1.99	0.43
1:A:305:GLU:O	1:A:309:ILE:HG23	2.19	0.43
2:B:46:LYS:HE2	2:B:116:PHE:HB3	2.00	0.43
1:C:113:ASP:HB3	1:C:116:PHE:HB2	2.00	0.43
2:D:393:ILE:HD13	2:D:398:TRP:HB2	2.00	0.43
1:C:40:GLU:HA	1:C:43:LYS:HD3	2.01	0.43
2:D:65:LYS:NZ	2:D:110:ASP:OD2	2.50	0.43
1:A:406:TRP:CZ3	1:A:407:GLN:HG3	2.54	0.43
1:C:331:LYS:HE2	1:C:333:GLY:O	2.19	0.43
1:A:57:ASN:OD1	1:A:131:THR:HG23	2.19	0.43
1:A:513:SER:O	1:A:519:ASN:ND2	2.52	0.43
2:B:297:GLU:HG2	2:B:298:GLU:H	1.84	0.43
1:C:172:LYS:HD3	1:C:180:ILE:HB	2.00	0.43
2:D:341:ILE:HD11	2:D:375:ILE:HG23	2.01	0.43
1:A:17:ASP:O	1:A:83:ARG:HD3	2.19	0.42
1:A:398:TRP:CZ2	1:A:411:ILE:HG12	2.54	0.42
1:A:450:THR:O	1:A:451:LYS:HG2	2.18	0.42
1:C:225:PRO:O	1:C:227:PHE:N	2.47	0.42
1:A:448:ARG:H	1:A:448:ARG:HG3	1.37	0.42
1:C:366:LYS:HE3	1:C:401:TRP:HH2	1.83	0.42
1:C:19:PRO:HD3	1:C:80:LEU:HD13	2.02	0.42
1:C:38:CYS:SG	1:C:132:ILE:HD11	2.59	0.42
1:C:256:ASP:OD1	1:C:257:ILE:N	2.52	0.42
1:A:503:LEU:HD12	1:A:533:LEU:HG	2.02	0.42
2:B:388:LYS:HD3	2:B:413:GLU:HB2	2.00	0.42
1:C:115:TYR:CD2	1:C:151:GLN:HA	2.54	0.42
2:D:80:LEU:O	2:D:84:THR:HG23	2.19	0.42
1:A:475:GLN:HB2	1:A:501:TYR:CD2	2.54	0.42
1:C:280:SER:HA	1:C:283:LEU:HD13	2.02	0.42
2:D:38:CYS:SG	2:D:132:ILE:HD11	2.60	0.42
1:A:21:VAL:O	1:A:57:ASN:ND2	2.53	0.42
1:A:278:GLN:CD	1:A:298:GLU:HB3	2.40	0.42
2:D:58:THR:HG21	2:D:77:PHE:CD1	2.54	0.42
1:A:412:PRO:HD3	2:B:401:TRP:CZ2	2.55	0.42
1:C:270:ILE:HG23	1:C:271:TYR:CD1	2.54	0.42
2:D:108:VAL:HB	2:D:232:TYR:HB3	2.02	0.41

*Continued on next page...*

Continued from previous page...

Atom-1	Atom-2	Interatomic distance (Å)	Clash overlap (Å)
1:A:367:GLN:HE22	1:A:512:LYS:HE3	1.85	0.41
2:D:263:LYS:HA	2:D:425:LEU:HD22	2.02	0.41
2:B:16:MET:HG2	1:C:292:VAL:HG11	2.01	0.41
2:D:8:VAL:HG21	2:D:159:ILE:HD13	2.02	0.41
1:C:342:TYR:HB3	1:C:348:ASN:HA	2.03	0.41
2:D:266:TRP:CD2	2:D:425:LEU:HD13	2.55	0.41
1:A:363:ASN:HA	1:A:511:ASP:OD1	2.21	0.41
2:B:123:ASP:O	2:B:126:LYS:NZ	2.54	0.41
2:B:177:ASP:OD1	2:B:177:ASP:N	2.51	0.41
1:A:131:THR:HG22	1:A:143:ARG:HE	1.86	0.41
1:A:172:LYS:HG2	1:A:180:ILE:HD12	2.02	0.41
1:A:284:ARG:H	1:A:284:ARG:HG2	1.70	0.41
1:C:111:VAL:HG12	1:C:185:ASP:O	2.21	0.41
2:D:386:THR:HA	2:D:387:PRO:HD3	1.94	0.41
1:A:361:HIS:CD2	1:A:505:ILE:HG23	2.56	0.41
2:B:282:LEU:HD21	2:B:296:THR:HG23	2.03	0.41
2:B:420:PRO:HA	2:B:421:PRO:HD3	1.96	0.41
1:C:162:SER:HB2	2:D:52:PRO:HG3	2.03	0.41
1:C:253:THR:HG23	1:C:256:ASP:H	1.85	0.41
1:A:270:ILE:HG23	1:A:271:TYR:CD1	2.55	0.40
2:B:171:PHE:CG	2:B:205:LEU:HD13	2.57	0.40
2:B:282:LEU:HD11	2:B:295:LEU:HA	2.04	0.40
2:D:244:ILE:HB	2:D:310:LEU:HD22	2.03	0.40
1:A:252:TRP:O	1:A:293:ILE:HG22	2.21	0.40
1:A:382:ILE:O	2:B:136:ASN:HB2	2.21	0.40
2:B:319:TYR:OH	2:B:385:LYS:NZ	2.55	0.40

All (1) symmetry-related close contacts are listed below. The label for Atom-2 includes the symmetry operator and encoded unit-cell translations to be applied.

Atom-1	Atom-2	Interatomic distance (Å)	Clash overlap (Å)
1:A:43:LYS:NZ	1:C:448:ARG:O[1_655]	2.18	0.02

## 5.3 Torsion angles [i](#)

### 5.3.1 Protein backbone [i](#)

In the following table, the Percentiles column shows the percent Ramachandran outliers of the chain as a percentile score with respect to all X-ray entries followed by that with respect to entries of similar resolution.

The Analysed column shows the number of residues for which the backbone conformation was analysed, and the total number of residues.

Mol	Chain	Analysed	Favoured	Allowed	Outliers	Percentiles	
1	A	535/557 (96%)	516 (96%)	19 (4%)	0	100	100
1	C	542/557 (97%)	526 (97%)	16 (3%)	0	100	100
2	B	399/429 (93%)	389 (98%)	10 (2%)	0	100	100
2	D	383/429 (89%)	374 (98%)	9 (2%)	0	100	100
All	All	1859/1972 (94%)	1805 (97%)	54 (3%)	0	100	100

There are no Ramachandran outliers to report.

### 5.3.2 Protein sidechains [i](#)

In the following table, the Percentiles column shows the percent sidechain outliers of the chain as a percentile score with respect to all X-ray entries followed by that with respect to entries of similar resolution.

The Analysed column shows the number of residues for which the sidechain conformation was analysed, and the total number of residues.

Mol	Chain	Analysed	Rotameric	Outliers	Percentiles	
1	A	483/497 (97%)	474 (98%)	9 (2%)	57	84
1	C	489/497 (98%)	483 (99%)	6 (1%)	71	91
2	B	367/390 (94%)	362 (99%)	5 (1%)	67	89
2	D	357/390 (92%)	352 (99%)	5 (1%)	67	89
All	All	1696/1774 (96%)	1671 (98%)	25 (2%)	65	87

All (25) residues with a non-rotameric sidechain are listed below:

Mol	Chain	Res	Type
1	A	142	ILE
1	A	218	ASP
1	A	259	LYS
1	A	264	LEU
1	A	276	VAL
1	A	284	ARG
1	A	307	ARG
1	A	448	ARG
1	A	449	GLU
2	B	7	THR

*Continued on next page...*



*Continued from previous page...*

Mol	Chain	Res	Type
2	B	249	LYS
2	B	344	GLU
2	B	423	VAL
2	B	427	TYR
1	C	40	GLU
1	C	182	GLN
1	C	218	ASP
1	C	274	ILE
1	C	275	LYS
1	C	428	GLN
2	D	7	THR
2	D	70	LYS
2	D	86	ASP
2	D	211	ARG
2	D	427	TYR

Sometimes sidechains can be flipped to improve hydrogen bonding and reduce clashes. All (1) such sidechains are listed below:

Mol	Chain	Res	Type
2	D	161	GLN

### 5.3.3 RNA [i](#)

There are no RNA molecules in this entry.

## 5.4 Non-standard residues in protein, DNA, RNA chains [i](#)

There are no non-standard protein/DNA/RNA residues in this entry.

## 5.5 Carbohydrates [i](#)

There are no monosaccharides in this entry.

## 5.6 Ligand geometry [i](#)

Of 4 ligands modelled in this entry, 3 are monoatomic - leaving 1 for Mogul analysis.

In the following table, the Counts columns list the number of bonds (or angles) for which Mogul statistics could be retrieved, the number of bonds (or angles) that are observed in the model and

the number of bonds (or angles) that are defined in the Chemical Component Dictionary. The Link column lists molecule types, if any, to which the group is linked. The Z score for a bond length (or angle) is the number of standard deviations the observed value is removed from the expected value. A bond length (or angle) with  $|Z| > 2$  is considered an outlier worth inspection. RMSZ is the root-mean-square of all Z scores of the bond lengths (or angles).

Mol	Type	Chain	Res	Link	Bond lengths			Bond angles		
					Counts	RMSZ	# Z  > 2	Counts	RMSZ	# Z  > 2
4	6FT	C	603	3	29,30,30	2.60	7 (24%)	42,44,44	2.07	5 (11%)

In the following table, the Chirals column lists the number of chiral outliers, the number of chiral centers analysed, the number of these observed in the model and the number defined in the Chemical Component Dictionary. Similar counts are reported in the Torsion and Rings columns. '-' means no outliers of that kind were identified.

Mol	Type	Chain	Res	Link	Chirals	Torsions	Rings
4	6FT	C	603	3	-	7/18/18/18	0/3/3/3

All (7) bond length outliers are listed below:

Mol	Chain	Res	Type	Atoms	Z	Observed(Å)	Ideal(Å)
4	C	603	6FT	C26-N08	6.70	1.49	1.37
4	C	603	6FT	C07-N08	6.65	1.49	1.37
4	C	603	6FT	C07-C03	5.57	1.53	1.38
4	C	603	6FT	S18-N20	5.50	1.71	1.60
4	C	603	6FT	C17-S18	3.05	1.81	1.77
4	C	603	6FT	C03-C04	2.67	1.53	1.48
4	C	603	6FT	O28-C27	2.49	1.40	1.34

All (5) bond angle outliers are listed below:

Mol	Chain	Res	Type	Atoms	Z	Observed(°)	Ideal(°)
4	C	603	6FT	O21-S18-O19	-10.54	101.43	118.76
4	C	603	6FT	O21-S18-C17	3.72	111.51	107.35
4	C	603	6FT	O19-S18-C17	3.16	110.88	107.35
4	C	603	6FT	O21-S18-N20	2.82	111.54	107.36
4	C	603	6FT	O19-S18-N20	2.48	111.04	107.36

There are no chirality outliers.

All (7) torsion outliers are listed below:

Mol	Chain	Res	Type	Atoms
4	C	603	6FT	C24-C13-C14-C23

*Continued on next page...*

Continued from previous page...

Mol	Chain	Res	Type	Atoms
4	C	603	6FT	C02-C03-C04-O05
4	C	603	6FT	C24-C13-C14-C15
4	C	603	6FT	C12-C13-C14-C15
4	C	603	6FT	C12-C13-C14-C23
4	C	603	6FT	C02-C03-C04-O06
4	C	603	6FT	N08-C09-C10-C11

There are no ring outliers.

1 monomer is involved in 1 short contact:

Mol	Chain	Res	Type	Clashes	Symm-Clashes
4	C	603	6FT	1	0

The following is a two-dimensional graphical depiction of Mogul quality analysis of bond lengths, bond angles, torsion angles, and ring geometry for all instances of the Ligand of Interest. In addition, ligands with molecular weight > 250 and outliers as shown on the validation Tables will also be included. For torsion angles, if less than 5% of the Mogul distribution of torsion angles is within 10 degrees of the torsion angle in question, then that torsion angle is considered an outlier. Any bond that is central to one or more torsion angles identified as an outlier by Mogul will be highlighted in the graph. For rings, the root-mean-square deviation (RMSD) between the ring in question and similar rings identified by Mogul is calculated over all ring torsion angles. If the average RMSD is greater than 60 degrees and the minimal RMSD between the ring in question and any Mogul-identified rings is also greater than 60 degrees, then that ring is considered an outlier. The outliers are highlighted in purple. The color gray indicates Mogul did not find sufficient equivalents in the CSD to analyse the geometry.

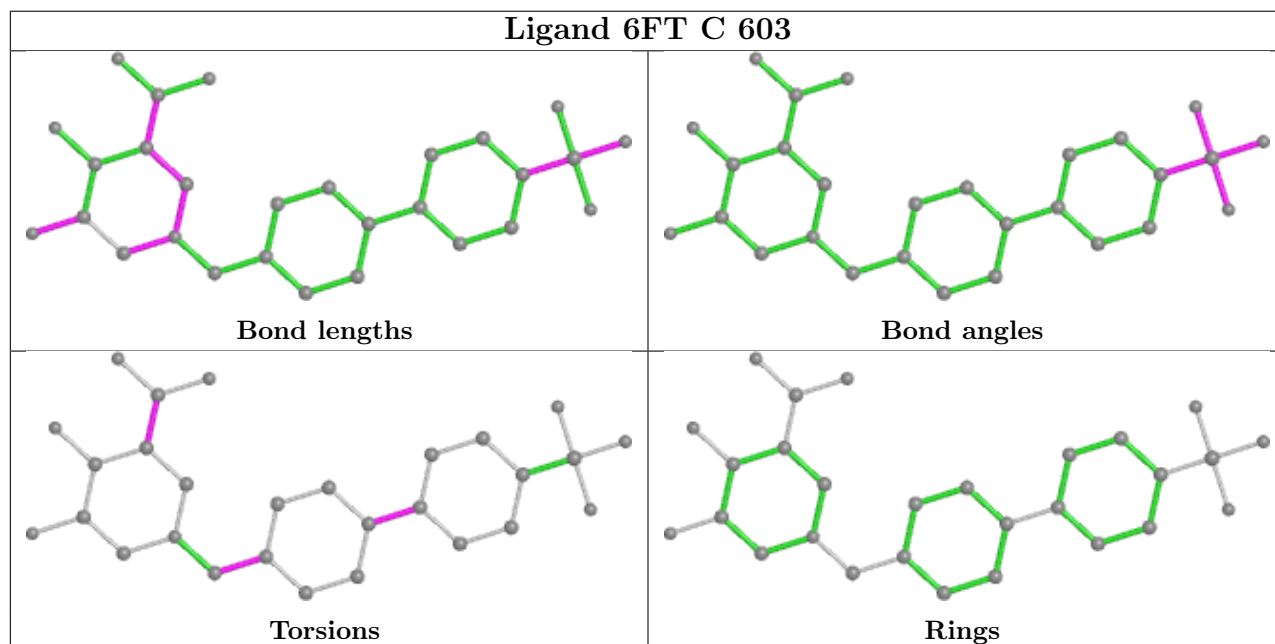

## 5.7 Other polymers [i](#)

There are no such residues in this entry.

## 5.8 Polymer linkage issues [i](#)

There are no chain breaks in this entry.

## 6 Fit of model and data

### 6.1 Protein, DNA and RNA chains

In the following table, the column labelled ‘#RSRZ > 2’ contains the number (and percentage) of RSRZ outliers, followed by percent RSRZ outliers for the chain as percentile scores relative to all X-ray entries and entries of similar resolution. The OWAB column contains the minimum, median, 95<sup>th</sup> percentile and maximum values of the occupancy-weighted average B-factor per residue. The column labelled ‘Q < 0.9’ lists the number of (and percentage) of residues with an average occupancy less than 0.9.

Mol	Chain	Analysed	<RSRZ>	#RSRZ>2	OWAB(Å <sup>2</sup> )	Q<0.9
1	A	541/557 (97%)	0.97	95 (17%) <b>1</b> <b>1</b>	36, 77, 138, 213	0
1	C	548/557 (98%)	0.73	51 (9%) <b>8</b> <b>6</b>	43, 70, 124, 166	0
2	B	405/429 (94%)	0.74	46 (11%) <b>5</b> <b>3</b>	36, 66, 124, 159	0
2	D	393/429 (91%)	0.66	31 (7%) <b>12</b> <b>10</b>	40, 60, 108, 126	0
All	All	1887/1972 (95%)	0.78	223 (11%) <b>4</b> <b>3</b>	36, 68, 126, 213	0

All (223) RSRZ outliers are listed below:

Mol	Chain	Res	Type	RSRZ
2	B	295	LEU	7.9
1	A	31	ILE	6.8
2	B	426	TRP	6.8
2	D	240	THR	6.7
1	A	216	THR	6.6
2	B	240	THR	6.4
2	D	232	TYR	6.2
1	A	283	LEU	6.0
2	B	247	PRO	5.8
1	A	217	PRO	5.7
1	A	71	TRP	5.5
1	C	551	LEU	5.5
1	A	249	LYS	5.2
1	A	115	TYR	5.2
2	D	7	THR	5.0
1	A	333	GLY	5.0
1	C	297	GLU	5.0
1	A	273	GLY	4.9
1	A	255	ASN	4.8
1	A	117	SER	4.7
1	A	293	ILE	4.7

*Continued on next page...*

*Continued from previous page...*

<b>Mol</b>	<b>Chain</b>	<b>Res</b>	<b>Type</b>	<b>RSRZ</b>
1	A	38	CYS	4.7
1	A	93	GLY	4.6
1	A	538	ALA	4.6
1	A	252	TRP	4.6
2	D	114	ALA	4.6
2	B	3	SER	4.5
2	D	241	VAL	4.5
2	D	423	VAL	4.5
1	A	297	GLU	4.3
2	B	270	ILE	4.3
1	A	259	LYS	4.3
1	A	72	ARG	4.3
2	D	204	GLU	4.3
1	A	280	SER	4.2
1	A	306	ASN	4.2
2	B	301	LEU	4.2
1	A	73	LYS	4.1
1	A	60	VAL	4.0
1	A	144	TYR	4.0
1	A	63	ILE	4.0
2	D	267	ALA	4.0
1	C	474	ASN	4.0
2	B	2	ILE	4.0
1	A	132	ILE	3.9
1	C	269	GLN	3.9
1	C	273	GLY	3.9
1	C	219	LYS	3.9
1	A	361	HIS	3.9
2	B	277	ARG	3.8
2	D	268	SER	3.8
1	A	180	ILE	3.8
1	C	402	TRP	3.8
1	A	250	ASP	3.8
2	B	208	HIS	3.8
1	C	63	ILE	3.7
1	A	197	GLN	3.7
1	C	22	LYS	3.7
1	A	35	VAL	3.7
1	C	290	THR	3.7
1	A	126	LYS	3.7
1	A	183	TYR	3.7
2	D	70	LYS	3.6

*Continued on next page...*

*Continued from previous page...*

<b>Mol</b>	<b>Chain</b>	<b>Res</b>	<b>Type</b>	<b>RSRZ</b>
1	C	531	VAL	3.6
1	A	307	ARG	3.6
2	D	160	PHE	3.6
2	D	421	PRO	3.6
1	A	34	LEU	3.6
1	A	274	ILE	3.5
1	C	334	GLN	3.5
2	D	215	THR	3.5
1	C	91	GLN	3.5
1	A	222	GLN	3.4
1	A	248	GLU	3.3
1	A	137	ASN	3.3
1	A	223	LYS	3.3
1	A	129	ALA	3.3
1	A	24	TRP	3.2
1	A	81	ASN	3.2
1	C	139	THR	3.2
2	B	268	SER	3.2
2	D	237	ASP	3.2
1	C	359	GLY	3.2
1	C	261	VAL	3.2
2	B	251	SER	3.1
1	C	357	MET	3.1
2	B	300	GLU	3.1
2	B	158	ALA	3.1
1	A	266	TRP	3.1
1	C	226	PRO	3.1
1	C	286	THR	3.1
2	B	142	ILE	3.0
2	B	281	LYS	3.0
2	D	176	PRO	3.0
2	B	279	LEU	3.0
1	A	128	THR	3.0
1	A	194	GLU	3.0
2	B	237	ASP	3.0
2	B	261	VAL	3.0
2	B	346	PHE	2.9
1	C	277	ARG	2.9
1	A	33	ALA	2.9
1	A	247	PRO	2.9
1	A	184	MET	2.9
1	A	130	PHE	2.9

*Continued on next page...*

*Continued from previous page...*

<b>Mol</b>	<b>Chain</b>	<b>Res</b>	<b>Type</b>	<b>RSRZ</b>
1	C	256	ASP	2.9
1	A	28	GLU	2.9
2	B	193	LEU	2.9
1	C	225	PRO	2.8
1	A	334	GLN	2.8
2	D	87	PHE	2.8
1	A	36	GLU	2.8
1	C	138	GLU	2.8
1	A	236	PRO	2.8
1	A	124	PHE	2.8
2	D	86	ASP	2.8
1	A	446	ALA	2.8
1	C	333	GLY	2.8
1	A	131	THR	2.8
2	B	0	GLY	2.7
2	D	161	GLN	2.7
2	D	158	ALA	2.7
2	B	176	PRO	2.7
2	B	243	PRO	2.7
1	A	29	GLU	2.7
1	A	260	LEU	2.7
2	B	293	ILE	2.7
1	C	279	LEU	2.7
2	B	87	PHE	2.6
1	A	145	GLN	2.6
1	C	257	ILE	2.6
1	A	10	VAL	2.6
1	C	282	LEU	2.6
1	A	312	GLU	2.6
2	D	96	HIS	2.6
1	A	200	THR	2.6
1	A	265	ASN	2.6
2	B	173	LYS	2.6
2	B	317	VAL	2.6
2	B	284	ARG	2.5
1	A	304	ALA	2.5
1	C	67	ASP	2.5
1	A	25	PRO	2.5
1	A	190	GLY	2.5
2	D	92	LEU	2.5
2	D	426	TRP	2.5
2	D	127	TYR	2.5

*Continued on next page...*



*Continued from previous page...*

<b>Mol</b>	<b>Chain</b>	<b>Res</b>	<b>Type</b>	<b>RSRZ</b>
2	B	231	GLY	2.5
1	C	354	TYR	2.5
1	A	261	VAL	2.5
2	B	245	VAL	2.4
1	C	311	LYS	2.4
2	B	244	ILE	2.4
2	B	303	LEU	2.4
1	C	92	LEU	2.4
2	B	266	TRP	2.4
2	B	276	VAL	2.4
1	A	15	GLY	2.4
2	B	113	ASP	2.4
2	B	178	ILE	2.4
2	B	248	GLU	2.4
1	A	289	LEU	2.4
2	B	318	TYR	2.4
1	C	195	ILE	2.4
1	C	491	LEU	2.4
2	D	170	PRO	2.4
1	A	186	ASP	2.4
1	C	358	ARG	2.4
1	A	150	PRO	2.4
1	A	545	ASN	2.4
1	A	438	GLU	2.4
2	B	212	TRP	2.3
1	C	224	GLU	2.3
1	A	198	HIS	2.3
1	A	227	PHE	2.3
1	C	90	VAL	2.3
2	B	425	LEU	2.3
1	C	291	GLU	2.3
2	D	99	GLY	2.3
1	C	468	PRO	2.3
1	C	191	SER	2.3
1	C	24	TRP	2.3
2	D	284	ARG	2.3
1	A	138	GLU	2.3
2	D	214	LEU	2.3
2	B	263	LYS	2.3
1	A	477	THR	2.2
1	C	152	GLY	2.2
1	C	487	GLN	2.2

*Continued on next page...*

*Continued from previous page...*

Mol	Chain	Res	Type	RSRZ
1	A	83	ARG	2.2
2	B	242	GLN	2.2
1	A	64	LYS	2.2
1	C	115	TYR	2.2
1	A	140	PRO	2.2
1	A	225	PRO	2.2
1	A	113	ASP	2.2
1	C	78	ARG	2.2
1	A	218	ASP	2.1
1	A	257	ILE	2.1
1	A	551	LEU	2.1
1	A	311	LYS	2.1
1	C	478	GLU	2.1
2	B	4	PRO	2.1
1	A	149	LEU	2.1
1	A	546	GLU	2.1
1	C	300	GLU	2.1
2	B	312	GLU	2.1
1	A	292	VAL	2.1
2	D	213	GLY	2.1
2	D	363	ASN	2.1
1	C	117	SER	2.1
1	C	511	ASP	2.1
1	A	436	GLY	2.1
1	A	139	THR	2.1
1	C	530	LYS	2.1
2	B	161	GLN	2.0
1	A	122	GLU	2.0
1	C	122	GLU	2.0
1	C	198	HIS	2.0
2	D	317	VAL	2.0
1	A	502	ALA	2.0
1	A	90	VAL	2.0
2	D	419	THR	2.0

## 6.2 Non-standard residues in protein, DNA, RNA chains [\(i\)](#)

There are no non-standard protein/DNA/RNA residues in this entry.

### 6.3 Carbohydrates [i](#)

There are no monosaccharides in this entry.

### 6.4 Ligands [i](#)

In the following table, the Atoms column lists the number of modelled atoms in the group and the number defined in the chemical component dictionary. The B-factors column lists the minimum, median, 95<sup>th</sup> percentile and maximum values of B factors of atoms in the group. The column labelled 'Q< 0.9' lists the number of atoms with occupancy less than 0.9.

Mol	Type	Chain	Res	Atoms	RSCC	RSR	B-factors(Å <sup>2</sup> )	Q<0.9
3	MG	A	601	1/1	0.37	0.24	113,113,113,113	0
3	MG	C	601	1/1	0.54	0.23	66,66,66,66	0
3	MG	C	602	1/1	0.61	0.11	67,67,67,67	0
4	6FT	C	603	28/28	0.73	0.49	60,82,99,101	28

The following is a graphical depiction of the model fit to experimental electron density of all instances of the Ligand of Interest. In addition, ligands with molecular weight > 250 and outliers as shown on the geometry validation Tables will also be included. Each fit is shown from different orientation to approximate a three-dimensional view.

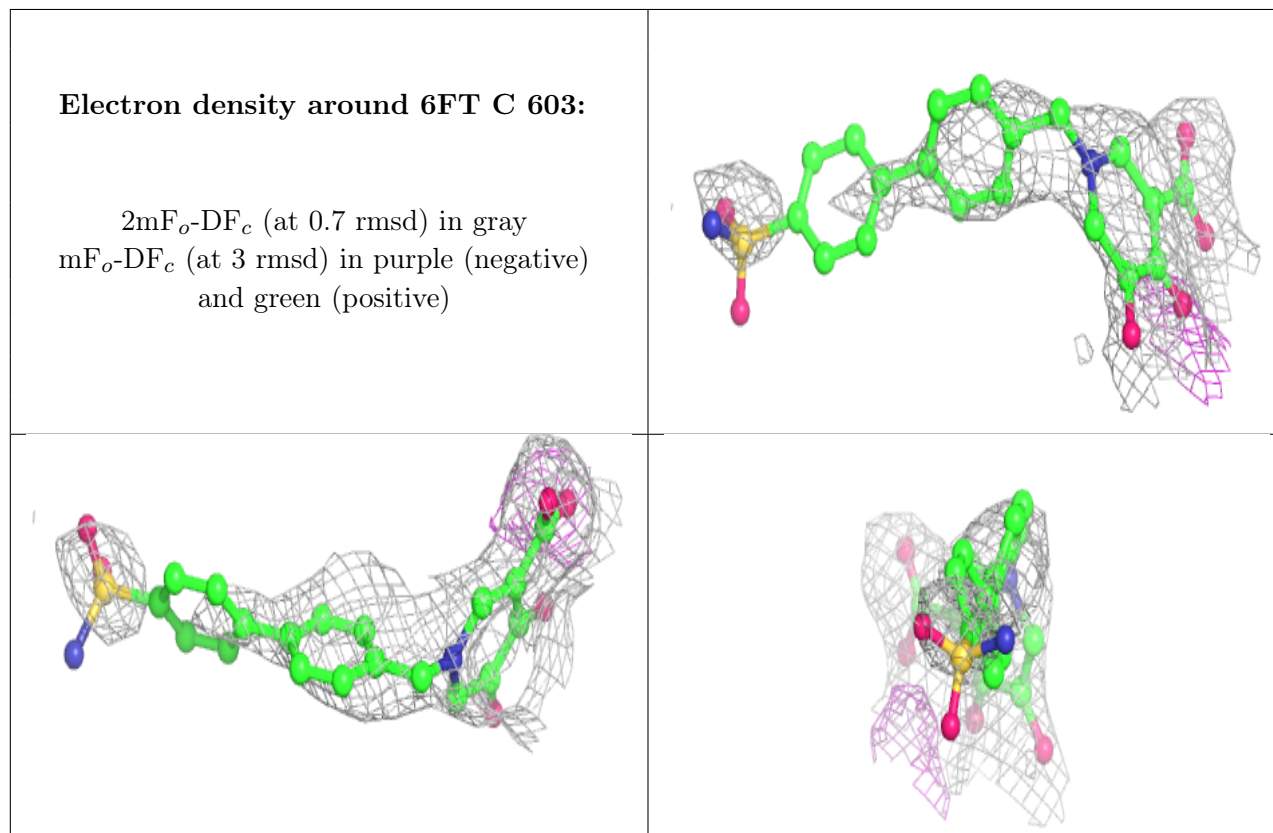

## 6.5 Other polymers [i](#)

There are no such residues in this entry.