



Full wwPDB X-ray Structure Validation Report ⓘ

Sep 7, 2023 – 02:40 AM EDT

PDB ID : 4FFB
Title : A TOG:alpha/beta-tubulin Complex Structure Reveals Conformation-Based Mechanisms For a Microtubule Polymerase
Authors : Ayaz, P.; Ye, X.; Huddleston, P.; Brautigam, C.A.; Rice, L.M.
Deposited on : 2012-05-31
Resolution : 2.88 Å(reported)

This is a Full wwPDB X-ray Structure Validation Report for a publicly released PDB entry.

We welcome your comments at validation@mail.wwpdb.org

A user guide is available at

<https://www.wwpdb.org/validation/2017/XrayValidationReportHelp>

with specific help available everywhere you see the ⓘ symbol.

The types of validation reports are described at

<http://www.wwpdb.org/validation/2017/FAQs#types>.

The following versions of software and data (see [references ⓘ](#)) were used in the production of this report:

MolProbity : 4.02b-467
Mogul : 1.8.5 (274361), CSD as541be (2020)
Xtriage (Phenix) : 1.13
EDS : 2.35
buster-report : 1.1.7 (2018)
Percentile statistics : 20191225.v01 (using entries in the PDB archive December 25th 2019)
Refmac : 5.8.0158
CCP4 : 7.0.044 (Gargrove)
Ideal geometry (proteins) : Engh & Huber (2001)
Ideal geometry (DNA, RNA) : Parkinson et al. (1996)
Validation Pipeline (wwPDB-VP) : 2.35

1 Overall quality at a glance

The following experimental techniques were used to determine the structure:

X-RAY DIFFRACTION

The reported resolution of this entry is 2.88 Å.

Percentile scores (ranging between 0-100) for global validation metrics of the entry are shown in the following graphic. The table shows the number of entries on which the scores are based.

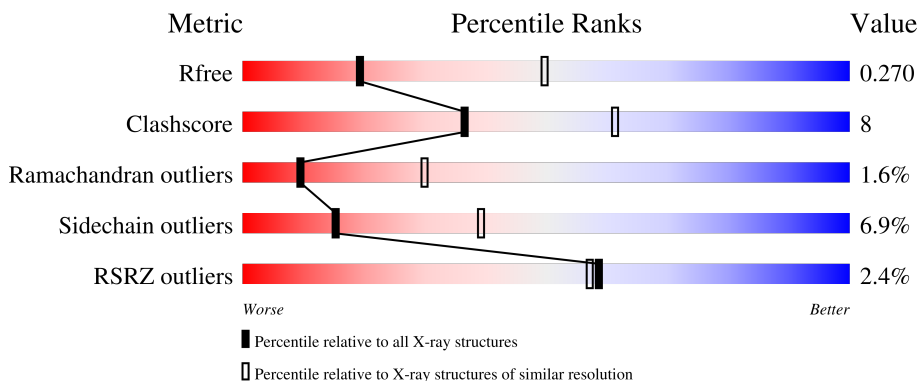

Metric	Whole archive (#Entries)	Similar resolution (#Entries, resolution range(Å))
R_{free}	130704	2691 (2.90-2.86)
Clashscore	141614	2947 (2.90-2.86)
Ramachandran outliers	138981	2868 (2.90-2.86)
Sidechain outliers	138945	2871 (2.90-2.86)
RSRZ outliers	127900	2629 (2.90-2.86)

The table below summarises the geometric issues observed across the polymeric chains and their fit to the electron density. The red, orange, yellow and green segments of the lower bar indicate the fraction of residues that contain outliers for ≥ 3 , 2, 1 and 0 types of geometric quality criteria respectively. A grey segment represents the fraction of residues that are not modelled. The numeric value for each fraction is indicated below the corresponding segment, with a dot representing fractions $\leq 5\%$. The upper red bar (where present) indicates the fraction of residues that have poor fit to the electron density. The numeric value is given above the bar.

Mol	Chain	Length	Quality of chain
1	A	447	
2	B	463	
3	C	278	

2 Entry composition

There are 5 unique types of molecules in this entry. The entry contains 8535 atoms, of which 0 are hydrogens and 0 are deuteriums.

In the tables below, the ZeroOcc column contains the number of atoms modelled with zero occupancy, the AltConf column contains the number of residues with at least one atom in alternate conformation and the Trace column contains the number of residues modelled with at most 2 atoms.

- Molecule 1 is a protein called Tubulin alpha-1 chain.

Mol	Chain	Residues	Atoms					ZeroOcc	AltConf	Trace
			Total	C	N	O	S			
1	A	435	3386	2134	575	658	19	0	0	0

- Molecule 2 is a protein called Tubulin beta chain.

Mol	Chain	Residues	Atoms					ZeroOcc	AltConf	Trace
			Total	C	N	O	S			
2	B	421	3283	2061	560	641	21	0	0	0

There are 8 discrepancies between the modelled and reference sequences:

Chain	Residue	Modelled	Actual	Comment	Reference
B	175	ARG	THR	engineered mutation	UNP P02557
B	179	ARG	VAL	engineered mutation	UNP P02557
B	458	HIS	-	expression tag	UNP P02557
B	459	HIS	-	expression tag	UNP P02557
B	460	HIS	-	expression tag	UNP P02557
B	461	HIS	-	expression tag	UNP P02557
B	462	HIS	-	expression tag	UNP P02557
B	463	HIS	-	expression tag	UNP P02557

- Molecule 3 is a protein called Protein STU2.

Mol	Chain	Residues	Atoms					ZeroOcc	AltConf	Trace
			Total	C	N	O	S			
3	C	231	1800	1165	302	327	6	0	0	0

There are 6 discrepancies between the modelled and reference sequences:

Chain	Residue	Modelled	Actual	Comment	Reference
C	273	HIS	-	expression tag	UNP P46675
C	274	HIS	-	expression tag	UNP P46675

Continued on next page...

Continued from previous page...

Chain	Residue	Modelled	Actual	Comment	Reference
C	275	HIS	-	expression tag	UNP P46675
C	276	HIS	-	expression tag	UNP P46675
C	277	HIS	-	expression tag	UNP P46675
C	278	HIS	-	expression tag	UNP P46675

- Molecule 4 is MAGNESIUM ION (three-letter code: MG) (formula: Mg).

Mol	Chain	Residues	Atoms	ZeroOcc	AltConf
4	A	1	Total Mg 1 1	0	0
4	B	1	Total Mg 1 1	0	0

- Molecule 5 is GUANOSINE-5'-TRIPHOSPHATE (three-letter code: GTP) (formula: C₁₀H₁₆N₅O₁₄P₃).

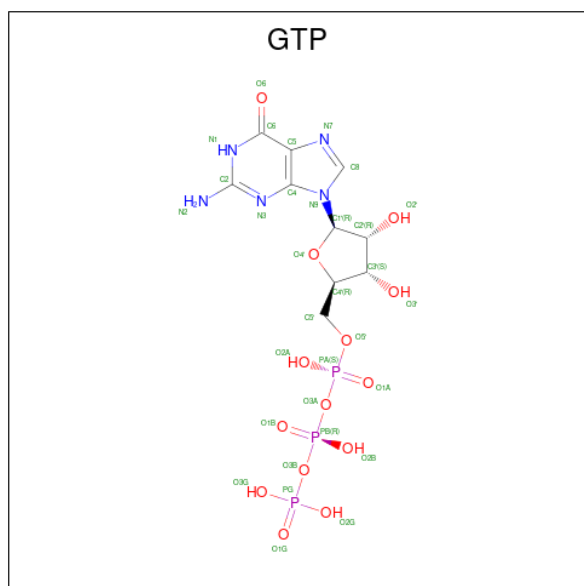

Mol	Chain	Residues	Atoms	ZeroOcc	AltConf
5	A	1	Total C N O P 32 10 5 14 3	0	0
5	B	1	Total C N O P 32 10 5 14 3	0	0

3 Residue-property plots [i](#)

These plots are drawn for all protein, RNA, DNA and oligosaccharide chains in the entry. The first graphic for a chain summarises the proportions of the various outlier classes displayed in the second graphic. The second graphic shows the sequence view annotated by issues in geometry and electron density. Residues are color-coded according to the number of geometric quality criteria for which they contain at least one outlier: green = 0, yellow = 1, orange = 2 and red = 3 or more. A red dot above a residue indicates a poor fit to the electron density ($RSRZ > 2$). Stretches of 2 or more consecutive residues without any outlier are shown as a green connector. Residues present in the sample, but not in the model, are shown in grey.

- Molecule 1: Tubulin alpha-1 chain

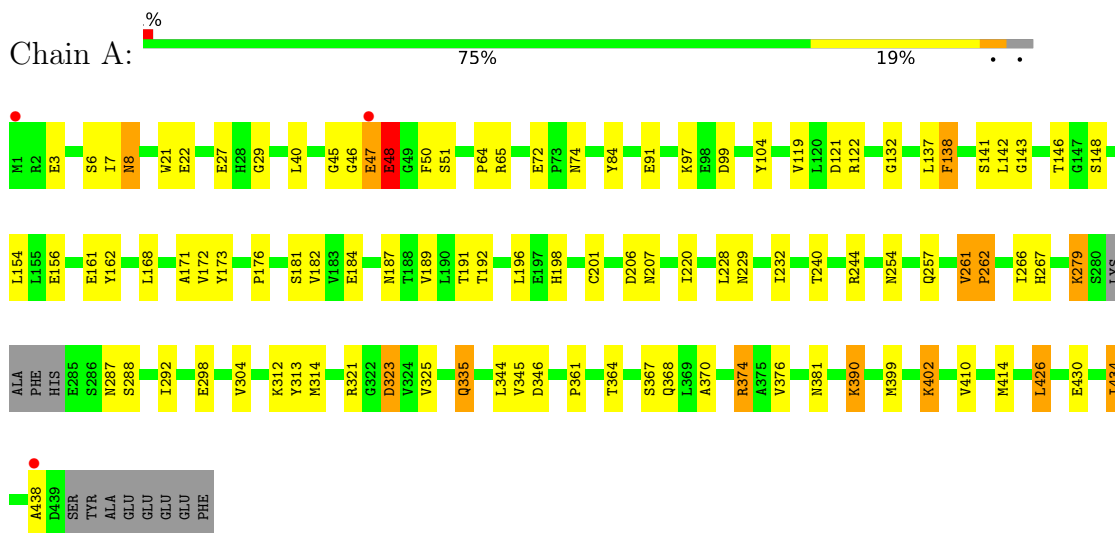

- Molecule 2: Tubulin beta chain

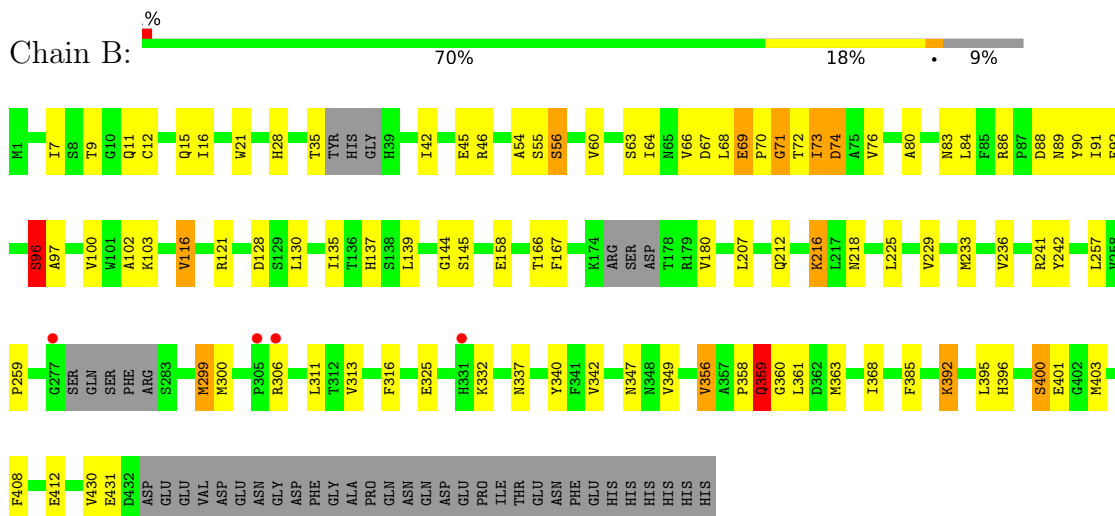

- Molecule 3: Protein STU2



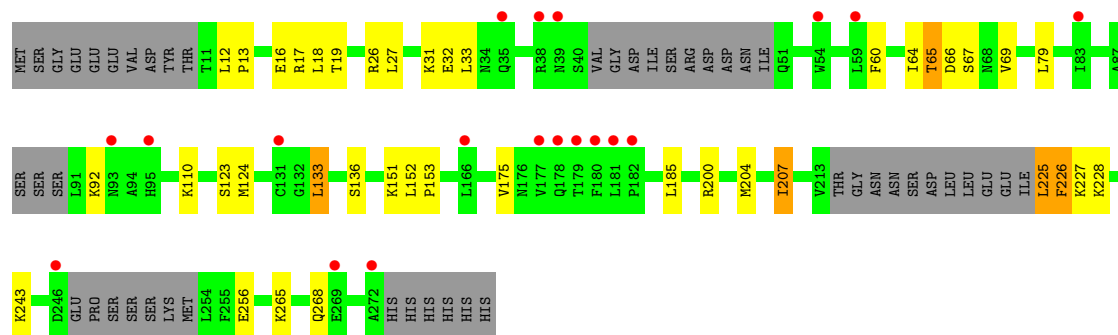

4 Data and refinement statistics

Property	Value	Source
Space group	P 1 21 1	Depositor
Cell constants a, b, c, α , β , γ	89.12Å 98.04Å 91.37Å 90.00° 100.31° 90.00°	Depositor
Resolution (Å)	44.95 – 2.88 44.95 – 2.88	Depositor EDS
% Data completeness (in resolution range)	74.6 (44.95-2.88) 74.6 (44.95-2.88)	Depositor EDS
R_{merge}	(Not available)	Depositor
R_{sym}	(Not available)	Depositor
$\langle I/\sigma(I) \rangle$ ¹	2.62 (at 2.91Å)	Xtrriage
Refinement program	PHENIX (phenix.refine: 1.8_1063)	Depositor
R, R_{free}	0.207 , 0.267 0.210 , 0.270	Depositor DCC
R_{free} test set	1040 reflections (3.97%)	wwPDB-VP
Wilson B-factor (Å ²)	46.7	Xtrriage
Anisotropy	0.480	Xtrriage
Bulk solvent k_{sol} (e/Å ³), B_{sol} (Å ²)	0.31 , 38.0	EDS
L-test for twinning ²	$\langle L \rangle = 0.49$, $\langle L^2 \rangle = 0.32$	Xtrriage
Estimated twinning fraction	0.024 for l,-k,h	Xtrriage
F_o, F_c correlation	0.91	EDS
Total number of atoms	8535	wwPDB-VP
Average B, all atoms (Å ²)	64.0	wwPDB-VP

Xtrriage's analysis on translational NCS is as follows: *The largest off-origin peak in the Patterson function is 4.64% of the height of the origin peak. No significant pseudotranslation is detected.*

¹Intensities estimated from amplitudes.

²Theoretical values of $\langle |L| \rangle$, $\langle L^2 \rangle$ for acentric reflections are 0.5, 0.333 respectively for untwinned datasets, and 0.375, 0.2 for perfectly twinned datasets.

5 Model quality

5.1 Standard geometry

Bond lengths and bond angles in the following residue types are not validated in this section: GTP, MG

The Z score for a bond length (or angle) is the number of standard deviations the observed value is removed from the expected value. A bond length (or angle) with $|Z| > 5$ is considered an outlier worth inspection. RMSZ is the root-mean-square of all Z scores of the bond lengths (or angles).

Mol	Chain	Bond lengths		Bond angles	
		RMSZ	# Z >5	RMSZ	# Z >5
1	A	0.23	0/3459	0.40	0/4693
2	B	0.23	0/3349	0.40	0/4533
3	C	0.24	0/1830	0.42	0/2481
All	All	0.23	0/8638	0.41	0/11707

There are no bond length outliers.

There are no bond angle outliers.

There are no chirality outliers.

There are no planarity outliers.

5.2 Too-close contacts

In the following table, the Non-H and H(model) columns list the number of non-hydrogen atoms and hydrogen atoms in the chain respectively. The H(added) column lists the number of hydrogen atoms added and optimized by MolProbity. The Clashes column lists the number of clashes within the asymmetric unit, whereas Symm-Clashes lists symmetry-related clashes.

Mol	Chain	Non-H	H(model)	H(added)	Clashes	Symm-Clashes
1	A	3386	0	3280	64	0
2	B	3283	0	3153	51	0
3	C	1800	0	1810	22	0
4	A	1	0	0	0	0
4	B	1	0	0	0	0
5	A	32	0	12	3	0
5	B	32	0	12	3	0
All	All	8535	0	8267	132	0

The all-atom clashscore is defined as the number of clashes found per 1000 atoms (including hydrogen atoms). The all-atom clashscore for this structure is 8.

All (132) close contacts within the same asymmetric unit are listed below, sorted by their clash magnitude.

Atom-1	Atom-2	Interatomic distance (Å)	Clash overlap (Å)
3:C:226:PHE:O	3:C:228:LYS:N	2.05	0.89
2:B:11:GLN:HA	2:B:72:THR:HG21	1.55	0.88
1:A:46:GLY:H	1:A:50:PHE:HB3	1.50	0.77
2:B:91:ILE:HG21	2:B:116:VAL:HG12	1.67	0.77
2:B:358:PRO:HG2	2:B:361:LEU:HB2	1.69	0.74
1:A:46:GLY:HA2	1:A:48:GLU:H	1.52	0.73
2:B:69:GLU:HG2	2:B:71:GLY:H	1.55	0.71
1:A:176:PRO:HB3	2:B:347:ASN:HD21	1.57	0.68
2:B:73:ILE:HD11	2:B:90:TYR:HB3	1.76	0.66
2:B:15:GLN:NE2	5:B:502:GTP:O6	2.30	0.65
1:A:410:VAL:O	3:C:200:ARG:NH2	2.32	0.63
1:A:142:LEU:HD11	1:A:171:ALA:HB1	1.83	0.61
2:B:96:SER:OG	2:B:97:ALA:N	2.31	0.61
2:B:86:ARG:HH11	2:B:89:ASN:HD21	1.49	0.61
2:B:9:THR:HG22	2:B:144:GLY:HA2	1.83	0.59
1:A:168:LEU:HD22	1:A:201:CYS:HB3	1.85	0.57
2:B:299:MET:HG3	2:B:300:MET:H	1.68	0.57
2:B:16:ILE:HD13	2:B:229:VAL:HG11	1.87	0.57
1:A:173:TYR:HB3	1:A:206:ASP:HA	1.87	0.57
1:A:313:TYR:O	1:A:345:VAL:HG23	2.05	0.56
1:A:402:LYS:HZ2	2:B:430:VAL:H	1.53	0.56
1:A:146:THR:HB	5:A:502:GTP:O1B	2.06	0.56
1:A:402:LYS:NZ	2:B:430:VAL:H	2.04	0.56
1:A:46:GLY:N	1:A:50:PHE:HB3	2.21	0.55
1:A:148:SER:HB2	1:A:191:THR:HG21	1.89	0.54
2:B:80:ALA:O	2:B:83:ASN:ND2	2.37	0.54
3:C:185:LEU:HD13	3:C:225:LEU:HB2	1.89	0.54
3:C:152:LEU:HD12	3:C:153:PRO:HD2	1.88	0.54
2:B:158:GLU:O	3:C:151:LYS:NZ	2.38	0.54
1:A:143:GLY:O	1:A:187:ASN:ND2	2.39	0.53
1:A:220:ILE:HD11	1:A:368:GLN:HG2	1.90	0.53
2:B:216:LYS:NZ	2:B:216:LYS:HB3	2.22	0.53
2:B:139:LEU:HA	2:B:145:SER:HB3	1.88	0.53
3:C:13:PRO:HG2	3:C:16:GLU:HG2	1.89	0.53
1:A:314:MET:HG3	1:A:345:VAL:HG21	1.90	0.53
2:B:54:ALA:O	2:B:56:SER:N	2.42	0.53
2:B:73:ILE:O	2:B:73:ILE:HG13	2.05	0.52
3:C:133:LEU:HD12	3:C:256:GLU:HG3	1.92	0.52
3:C:265:LYS:HA	3:C:268:GLN:HG2	1.90	0.52
1:A:119:VAL:HG11	1:A:154:LEU:HD21	1.91	0.52

Continued on next page...

Continued from previous page...

Atom-1	Atom-2	Interatomic distance (Å)	Clash overlap (Å)
1:A:138:PHE:HZ	1:A:154:LEU:HB3	1.75	0.51
2:B:313:VAL:HB	2:B:349:VAL:HG22	1.92	0.51
3:C:65:THR:O	3:C:65:THR:OG1	2.27	0.51
1:A:46:GLY:HA2	1:A:48:GLU:N	2.22	0.51
1:A:192:THR:HB	1:A:426:LEU:HD11	1.93	0.50
2:B:167:PHE:CE1	2:B:233:MET:HG2	2.46	0.50
1:A:137:LEU:HD23	1:A:168:LEU:HB2	1.93	0.50
1:A:312:LYS:HB3	1:A:345:VAL:HG22	1.94	0.50
1:A:402:LYS:NZ	2:B:430:VAL:O	2.29	0.50
2:B:299:MET:HG3	2:B:300:MET:N	2.26	0.50
1:A:207:ASN:ND2	5:A:502:GTP:O2'	2.44	0.50
2:B:21:TRP:CZ2	2:B:63:SER:HB2	2.47	0.49
1:A:201:CYS:HA	1:A:267:HIS:HB2	1.94	0.49
2:B:68:LEU:HD23	2:B:97:ALA:HB2	1.95	0.49
2:B:66:VAL:HG22	2:B:91:ILE:HB	1.95	0.49
2:B:359:GLN:HA	2:B:361:LEU:H	1.77	0.48
1:A:27:GLU:OE1	1:A:244:ARG:NH2	2.38	0.48
2:B:242:TYR:CZ	2:B:356:VAL:HG11	2.49	0.48
2:B:385:PHE:CE2	2:B:412:GLU:HB2	2.49	0.48
1:A:187:ASN:O	1:A:191:THR:HG23	2.14	0.48
3:C:13:PRO:O	3:C:17:ARG:HG3	2.14	0.47
1:A:46:GLY:H	1:A:50:PHE:CB	2.24	0.47
1:A:292:ILE:HB	1:A:376:VAL:HG12	1.96	0.47
1:A:390:LYS:HG3	1:A:430:GLU:OE1	2.15	0.47
2:B:392:LYS:HB3	2:B:395:LEU:HD12	1.96	0.47
1:A:229:ASN:OD1	5:A:502:GTP:N1	2.34	0.46
1:A:104:TYR:CE1	1:A:191:THR:HG22	2.50	0.46
1:A:414:MET:HB2	1:A:414:MET:HE3	1.67	0.46
1:A:91:GLU:O	1:A:122:ARG:NH1	2.48	0.46
2:B:207:LEU:HB3	2:B:225:LEU:HD22	1.97	0.46
1:A:181:SER:HB3	1:A:184:GLU:HG3	1.98	0.46
3:C:204:MET:HA	3:C:207:ILE:HG13	1.98	0.46
1:A:161:GLU:HG3	1:A:162:TYR:CD2	2.51	0.46
5:B:502:GTP:H8	5:B:502:GTP:O2A	1.99	0.46
3:C:64:ILE:HD11	3:C:79:LEU:HG	1.99	0.46
1:A:21:TRP:CZ3	1:A:64:PRO:HB3	2.52	0.45
1:A:254:ASN:HA	1:A:257:GLN:HE21	1.82	0.45
2:B:100:VAL:HG23	2:B:103:LYS:HG3	1.98	0.45
1:A:182:VAL:O	1:A:399:MET:HE1	2.17	0.45
2:B:212:GLN:O	2:B:216:LYS:HA	2.17	0.45
1:A:7:ILE:C	1:A:8:ASN:HD22	2.20	0.45

Continued on next page...

Continued from previous page...

Atom-1	Atom-2	Interatomic distance (Å)	Clash overlap (Å)
3:C:67:SER:O	3:C:67:SER:OG	2.29	0.45
1:A:29:GLY:HA3	1:A:40:LEU:HD11	1.98	0.45
1:A:8:ASN:HD22	1:A:8:ASN:N	2.14	0.44
3:C:27:LEU:O	3:C:31:LYS:HG3	2.17	0.44
1:A:72:GLU:HB3	1:A:99:ASP:HB3	1.98	0.44
1:A:261:VAL:HA	1:A:262:PRO:HD3	1.84	0.44
1:A:189:VAL:HG13	1:A:426:LEU:HD13	1.99	0.43
1:A:240:THR:OG1	1:A:244:ARG:NH1	2.51	0.43
2:B:64:ILE:HG22	2:B:66:VAL:HG23	2.00	0.43
3:C:136:SER:HB2	3:C:175:VAL:HG22	2.00	0.43
1:A:45:GLY:HA3	1:A:50:PHE:HB2	2.00	0.43
1:A:138:PHE:CZ	1:A:154:LEU:HB3	2.52	0.43
2:B:257:LEU:O	2:B:259:PRO:HD3	2.18	0.43
2:B:28:HIS:NE2	2:B:241:ARG:HD2	2.33	0.43
1:A:192:THR:O	1:A:196:LEU:HB2	2.18	0.43
1:A:22:GLU:HG2	1:A:84:TYR:CZ	2.53	0.43
1:A:156:GLU:HG2	1:A:198:HIS:CD2	2.54	0.43
1:A:3:GLU:HG2	1:A:65:ARG:CZ	2.49	0.43
1:A:161:GLU:HG3	1:A:162:TYR:CE2	2.54	0.43
3:C:26:ARG:NH1	3:C:66:ASP:OD1	2.52	0.43
2:B:42:ILE:HG22	2:B:242:TYR:HD1	1.84	0.43
3:C:17:ARG:NH2	3:C:32:GLU:OE2	2.37	0.43
2:B:7:ILE:HB	2:B:135:ILE:HG12	2.00	0.42
1:A:206:ASP:HB3	1:A:304:VAL:HA	2.00	0.42
1:A:141:SER:HA	1:A:172:VAL:HB	2.01	0.42
1:A:279:LYS:HA	1:A:370:ALA:HB2	2.01	0.42
1:A:323:ASP:O	1:A:374:ARG:HD2	2.19	0.42
2:B:12:CYS:HB2	5:B:502:GTP:C4	2.54	0.41
2:B:67:ASP:O	2:B:92:PHE:HA	2.19	0.41
2:B:396:HIS:O	2:B:400:SER:HB3	2.19	0.41
2:B:385:PHE:CZ	2:B:408:PHE:HD2	2.38	0.41
1:A:335:GLN:HE21	1:A:335:GLN:HB3	1.60	0.41
1:A:228:LEU:O	1:A:232:ILE:HG13	2.21	0.41
2:B:316:PHE:HE2	2:B:368:ILE:HD12	1.86	0.41
2:B:359:GLN:HE21	2:B:359:GLN:HB3	1.68	0.41
3:C:60:PHE:O	3:C:64:ILE:HG12	2.21	0.41
1:A:321:ARG:HB3	1:A:361:PRO:HD3	2.02	0.41
3:C:18:LEU:HD11	3:C:33:LEU:HD11	2.03	0.41
1:A:47:GLU:H	1:A:47:GLU:CD	2.24	0.41
1:A:266:ILE:HG22	1:A:381:ASN:HD21	1.85	0.41
2:B:70:PRO:O	2:B:74:ASP:HB2	2.21	0.41

Continued on next page...

Continued from previous page...

Atom-1	Atom-2	Interatomic distance (Å)	Clash overlap (Å)
3:C:17:ARG:HE	3:C:17:ARG:HB2	1.59	0.41
3:C:60:PHE:CD1	3:C:79:LEU:HD23	2.56	0.41
2:B:236:VAL:HG13	2:B:368:ILE:HD11	2.03	0.40
3:C:110:LYS:HB3	3:C:110:LYS:HE2	1.80	0.40
2:B:86:ARG:NH1	2:B:89:ASN:HD21	2.18	0.40
2:B:337:ASN:HB3	2:B:340:TYR:CD2	2.57	0.40
2:B:359:GLN:HA	2:B:360:GLY:HA2	1.75	0.40
1:A:72:GLU:HG3	1:A:74:ASN:H	1.86	0.40
1:A:430:GLU:O	1:A:434:ILE:HG23	2.22	0.40
2:B:102:ALA:HB1	2:B:401:GLU:HB2	2.03	0.40

There are no symmetry-related clashes.

5.3 Torsion angles [i](#)

5.3.1 Protein backbone [i](#)

In the following table, the Percentiles column shows the percent Ramachandran outliers of the chain as a percentile score with respect to all X-ray entries followed by that with respect to entries of similar resolution.

The Analysed column shows the number of residues for which the backbone conformation was analysed, and the total number of residues.

Mol	Chain	Analysed	Favoured	Allowed	Outliers	Percentiles	
1	A	431/447 (96%)	408 (95%)	18 (4%)	5 (1%)	13	38
2	B	413/463 (89%)	372 (90%)	33 (8%)	8 (2%)	8	26
3	C	221/278 (80%)	202 (91%)	15 (7%)	4 (2%)	8	27
All	All	1065/1188 (90%)	982 (92%)	66 (6%)	17 (2%)	9	30

All (17) Ramachandran outliers are listed below:

Mol	Chain	Res	Type
1	A	48	GLU
2	B	359	GLN
3	C	226	PHE
3	C	227	LYS
2	B	55	SER
1	A	438	ALA
2	B	56	SER

Continued on next page...

Continued from previous page...

Mol	Chain	Res	Type
1	A	323	ASP
2	B	96	SER
2	B	218	ASN
3	C	92	LYS
1	A	132	GLY
2	B	45	GLU
3	C	243	LYS
1	A	262	PRO
2	B	69	GLU
2	B	71	GLY

5.3.2 Protein sidechains [i](#)

In the following table, the Percentiles column shows the percent sidechain outliers of the chain as a percentile score with respect to all X-ray entries followed by that with respect to entries of similar resolution.

The Analysed column shows the number of residues for which the sidechain conformation was analysed, and the total number of residues.

Mol	Chain	Analysed	Rotameric	Outliers	Percentiles	
1	A	368/381 (97%)	344 (94%)	24 (6%)	17	42
2	B	357/398 (90%)	327 (92%)	30 (8%)	11	30
3	C	190/250 (76%)	181 (95%)	9 (5%)	26	57
All	All	915/1029 (89%)	852 (93%)	63 (7%)	15	39

All (63) residues with a non-rotameric sidechain are listed below:

Mol	Chain	Res	Type
1	A	6	SER
1	A	8	ASN
1	A	47	GLU
1	A	48	GLU
1	A	51	SER
1	A	97	LYS
1	A	121	ASP
1	A	138	PHE
1	A	261	VAL
1	A	279	LYS
1	A	287	ASN
1	A	288	SER

Continued on next page...

Continued from previous page...

Mol	Chain	Res	Type
1	A	298	GLU
1	A	325	VAL
1	A	335	GLN
1	A	344	LEU
1	A	346	ASP
1	A	364	THR
1	A	367	SER
1	A	374	ARG
1	A	390	LYS
1	A	402	LYS
1	A	426	LEU
1	A	434	ILE
2	B	35	THR
2	B	46	ARG
2	B	60	VAL
2	B	73	ILE
2	B	74	ASP
2	B	76	VAL
2	B	84	LEU
2	B	88	ASP
2	B	96	SER
2	B	116	VAL
2	B	121	ARG
2	B	128	ASP
2	B	130	LEU
2	B	137	HIS
2	B	166	THR
2	B	180	VAL
2	B	216	LYS
2	B	299	MET
2	B	306	ARG
2	B	311	LEU
2	B	325	GLU
2	B	332	LYS
2	B	342	VAL
2	B	356	VAL
2	B	359	GLN
2	B	363	MET
2	B	392	LYS
2	B	400	SER
2	B	403	MET
2	B	431	GLU

Continued on next page...

Continued from previous page...

Mol	Chain	Res	Type
3	C	12	LEU
3	C	19	THR
3	C	65	THR
3	C	69	VAL
3	C	123	SER
3	C	124	MET
3	C	133	LEU
3	C	207	ILE
3	C	225	LEU

Sometimes sidechains can be flipped to improve hydrogen bonding and reduce clashes. All (5) such sidechains are listed below:

Mol	Chain	Res	Type
1	A	8	ASN
1	A	257	GLN
2	B	15	GLN
2	B	48	ASN
2	B	359	GLN

5.3.3 RNA [i](#)

There are no RNA molecules in this entry.

5.4 Non-standard residues in protein, DNA, RNA chains [i](#)

There are no non-standard protein/DNA/RNA residues in this entry.

5.5 Carbohydrates [i](#)

There are no monosaccharides in this entry.

5.6 Ligand geometry [i](#)

Of 4 ligands modelled in this entry, 2 are monoatomic - leaving 2 for Mogul analysis.

In the following table, the Counts columns list the number of bonds (or angles) for which Mogul statistics could be retrieved, the number of bonds (or angles) that are observed in the model and the number of bonds (or angles) that are defined in the Chemical Component Dictionary. The Link column lists molecule types, if any, to which the group is linked. The Z score for a bond

length (or angle) is the number of standard deviations the observed value is removed from the expected value. A bond length (or angle) with $|Z| > 2$ is considered an outlier worth inspection. RMSZ is the root-mean-square of all Z scores of the bond lengths (or angles).

Mol	Type	Chain	Res	Link	Bond lengths			Bond angles		
					Counts	RMSZ	# Z > 2	Counts	RMSZ	# Z > 2
5	GTP	B	502	4	26,34,34	1.14	2 (7%)	32,54,54	1.58	7 (21%)
5	GTP	A	502	4	26,34,34	1.12	2 (7%)	32,54,54	1.59	7 (21%)

In the following table, the Chirals column lists the number of chiral outliers, the number of chiral centers analysed, the number of these observed in the model and the number defined in the Chemical Component Dictionary. Similar counts are reported in the Torsion and Rings columns. '-' means no outliers of that kind were identified.

Mol	Type	Chain	Res	Link	Chirals	Torsions	Rings
5	GTP	B	502	4	-	7/18/38/38	0/3/3/3
5	GTP	A	502	4	-	3/18/38/38	0/3/3/3

All (4) bond length outliers are listed below:

Mol	Chain	Res	Type	Atoms	Z	Observed(Å)	Ideal(Å)
5	B	502	GTP	C5-C6	-4.06	1.39	1.47
5	A	502	GTP	C5-C6	-3.98	1.39	1.47
5	B	502	GTP	C2-N3	2.25	1.38	1.33
5	A	502	GTP	C2-N3	2.10	1.38	1.33

All (14) bond angle outliers are listed below:

Mol	Chain	Res	Type	Atoms	Z	Observed(°)	Ideal(°)
5	B	502	GTP	PB-O3B-PG	-3.82	119.72	132.83
5	A	502	GTP	PB-O3B-PG	-3.37	121.25	132.83
5	B	502	GTP	C5-C6-N1	3.21	119.62	113.95
5	A	502	GTP	C5-C6-N1	3.17	119.55	113.95
5	A	502	GTP	PA-O3A-PB	-3.16	121.98	132.83
5	A	502	GTP	C8-N7-C5	3.02	108.75	102.99
5	B	502	GTP	C8-N7-C5	2.87	108.47	102.99
5	B	502	GTP	C2-N1-C6	-2.87	119.82	125.10
5	A	502	GTP	C2-N1-C6	-2.83	119.89	125.10
5	B	502	GTP	C3'-C2'-C1'	2.71	105.06	100.98
5	B	502	GTP	PA-O3A-PB	-2.69	123.59	132.83
5	A	502	GTP	C3'-C2'-C1'	2.68	105.02	100.98
5	B	502	GTP	O6-C6-C5	-2.27	119.94	124.37
5	A	502	GTP	O6-C6-C5	-2.01	120.45	124.37

There are no chirality outliers.

All (10) torsion outliers are listed below:

Mol	Chain	Res	Type	Atoms
5	B	502	GTP	C5'-O5'-PA-O1A
5	B	502	GTP	C5'-O5'-PA-O2A
5	B	502	GTP	C3'-C4'-C5'-O5'
5	A	502	GTP	C4'-C5'-O5'-PA
5	A	502	GTP	PB-O3A-PA-O2A
5	B	502	GTP	PA-O3A-PB-O1B
5	B	502	GTP	C4'-C5'-O5'-PA
5	B	502	GTP	O4'-C4'-C5'-O5'
5	B	502	GTP	C5'-O5'-PA-O3A
5	A	502	GTP	PB-O3A-PA-O1A

There are no ring outliers.

2 monomers are involved in 6 short contacts:

Mol	Chain	Res	Type	Clashes	Symm-Clashes
5	B	502	GTP	3	0
5	A	502	GTP	3	0

The following is a two-dimensional graphical depiction of Mogul quality analysis of bond lengths, bond angles, torsion angles, and ring geometry for all instances of the Ligand of Interest. In addition, ligands with molecular weight > 250 and outliers as shown on the validation Tables will also be included. For torsion angles, if less than 5% of the Mogul distribution of torsion angles is within 10 degrees of the torsion angle in question, then that torsion angle is considered an outlier. Any bond that is central to one or more torsion angles identified as an outlier by Mogul will be highlighted in the graph. For rings, the root-mean-square deviation (RMSD) between the ring in question and similar rings identified by Mogul is calculated over all ring torsion angles. If the average RMSD is greater than 60 degrees and the minimal RMSD between the ring in question and any Mogul-identified rings is also greater than 60 degrees, then that ring is considered an outlier. The outliers are highlighted in purple. The color gray indicates Mogul did not find sufficient equivalents in the CSD to analyse the geometry.

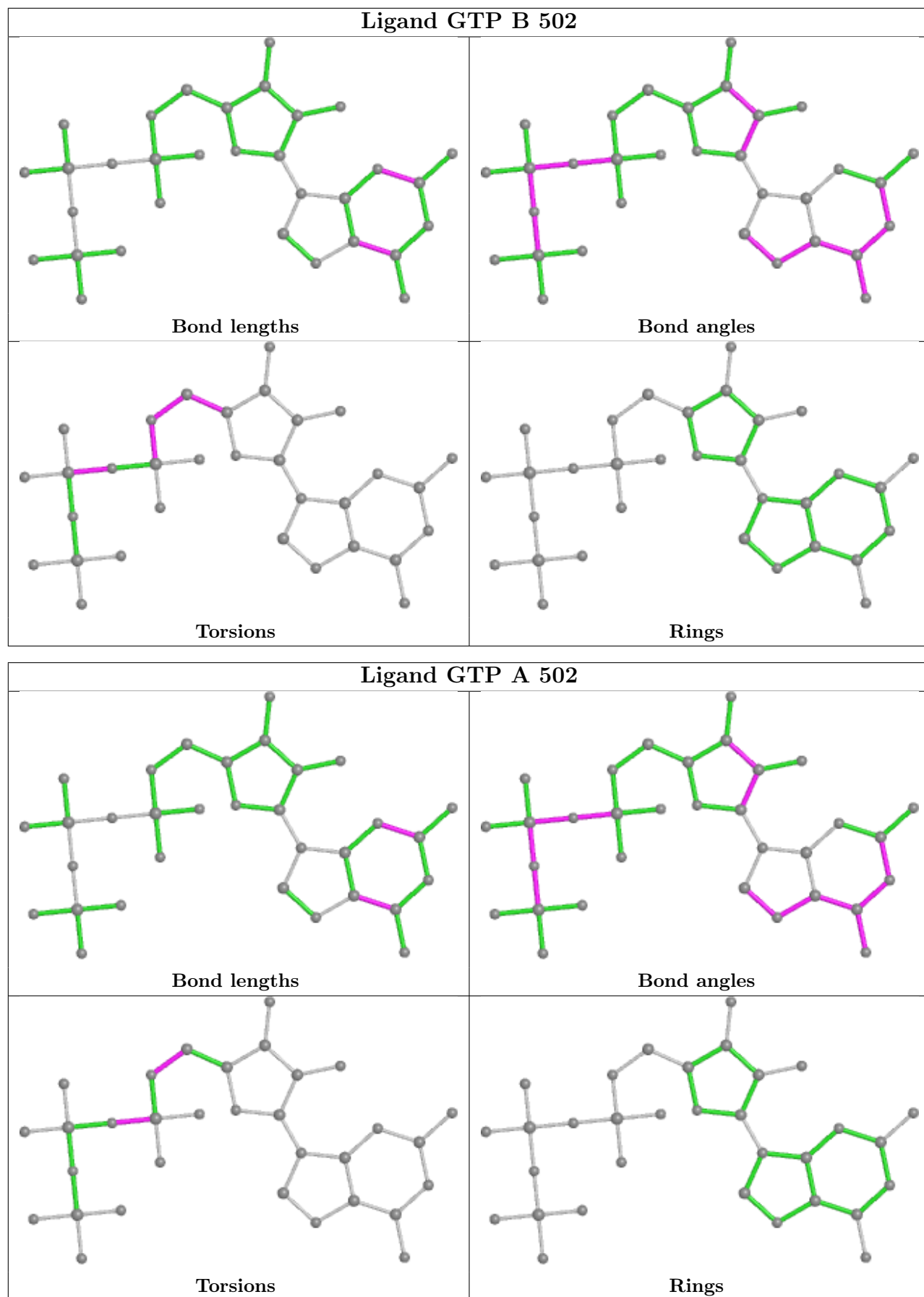

5.7 Other polymers [i](#)

There are no such residues in this entry.

5.8 Polymer linkage issues [i](#)

There are no chain breaks in this entry.

6 Fit of model and data

6.1 Protein, DNA and RNA chains

In the following table, the column labelled ‘#RSRZ > 2’ contains the number (and percentage) of RSRZ outliers, followed by percent RSRZ outliers for the chain as percentile scores relative to all X-ray entries and entries of similar resolution. The OWAB column contains the minimum, median, 95th percentile and maximum values of the occupancy-weighted average B-factor per residue. The column labelled ‘Q < 0.9’ lists the number of (and percentage) of residues with an average occupancy less than 0.9.

Mol	Chain	Analysed	<RSRZ>	#RSRZ>2	OWAB(Å ²)	Q<0.9
1	A	435/447 (97%)	-0.27	3 (0%) 87 87	26, 47, 87, 139	0
2	B	421/463 (90%)	-0.08	4 (0%) 82 82	32, 65, 103, 148	0
3	C	231/278 (83%)	0.38	19 (8%) 11 8	44, 79, 113, 131	1 (0%)
All	All	1087/1188 (91%)	-0.06	26 (2%) 59 57	26, 61, 104, 148	1 (0%)

All (26) RSRZ outliers are listed below:

Mol	Chain	Res	Type	RSRZ
2	B	277	GLY	5.4
1	A	1	MET	3.8
3	C	246	ASP	3.1
3	C	181	LEU	3.0
3	C	177	VAL	2.9
3	C	179	THR	2.7
1	A	47	GLU	2.7
3	C	35	GLN	2.6
3	C	180	PHE	2.6
3	C	59	LEU	2.6
3	C	182	PRO	2.6
3	C	38	ARG	2.5
3	C	93	ASN	2.5
2	B	306	ARG	2.4
3	C	272	ALA	2.4
3	C	178	GLN	2.3
2	B	305	PRO	2.2
3	C	83	ILE	2.2
3	C	166	LEU	2.2
2	B	331	HIS	2.2
3	C	95	HIS	2.1
1	A	438	ALA	2.1
3	C	131	CYS	2.1

Continued on next page...

Continued from previous page...

Mol	Chain	Res	Type	RSRZ
3	C	39	ASN	2.1
3	C	269	GLU	2.0
3	C	54	TRP	2.0

6.2 Non-standard residues in protein, DNA, RNA chains [i](#)

There are no non-standard protein/DNA/RNA residues in this entry.

6.3 Carbohydrates [i](#)

There are no monosaccharides in this entry.

6.4 Ligands [i](#)

In the following table, the Atoms column lists the number of modelled atoms in the group and the number defined in the chemical component dictionary. The B-factors column lists the minimum, median, 95th percentile and maximum values of B factors of atoms in the group. The column labelled 'Q< 0.9' lists the number of atoms with occupancy less than 0.9.

Mol	Type	Chain	Res	Atoms	RSCC	RSR	B-factors(Å ²)	Q<0.9
4	MG	B	501	1/1	0.87	0.28	33,33,33,33	0
4	MG	A	501	1/1	0.94	0.45	37,37,37,37	0
5	GTP	B	502	32/32	0.95	0.15	57,57,57,57	0
5	GTP	A	502	32/32	0.96	0.22	35,35,35,35	0

The following is a graphical depiction of the model fit to experimental electron density of all instances of the Ligand of Interest. In addition, ligands with molecular weight > 250 and outliers as shown on the geometry validation Tables will also be included. Each fit is shown from different orientation to approximate a three-dimensional view.

Electron density around GTP B 502:

$2mF_o-DF_c$ (at 0.7 rmsd) in gray
 mF_o-DF_c (at 3 rmsd) in purple (negative)
and green (positive)

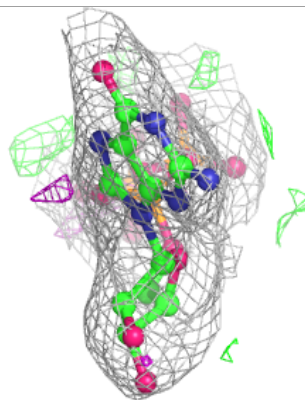
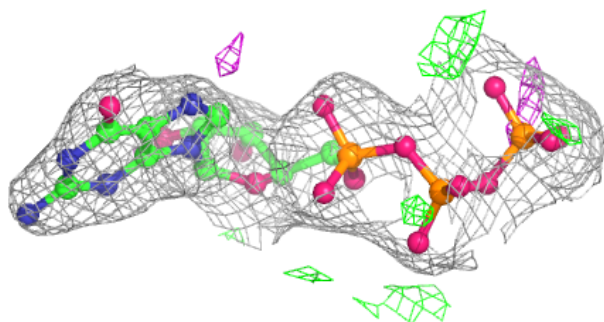
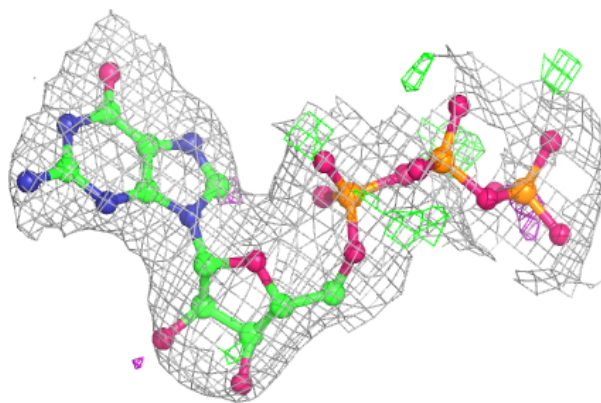
**Electron density around GTP A 502:**

$2mF_o-DF_c$ (at 0.7 rmsd) in gray
 mF_o-DF_c (at 3 rmsd) in purple (negative)
and green (positive)

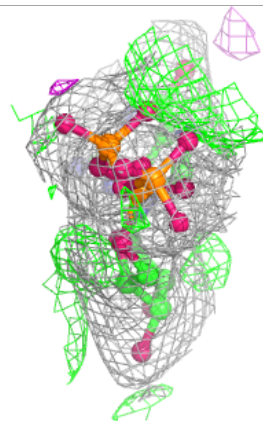
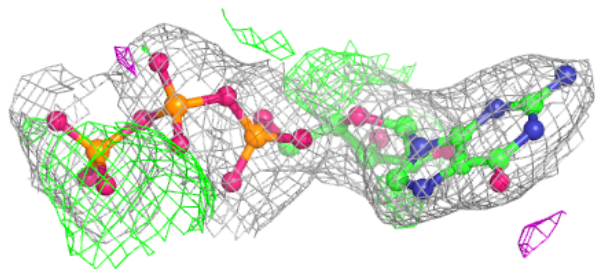
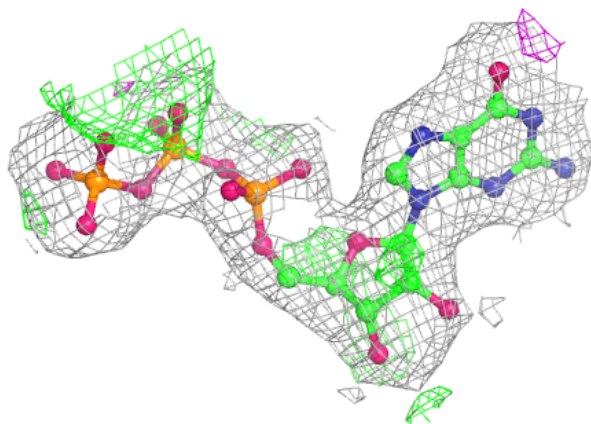

6.5 Other polymers [i](#)

There are no such residues in this entry.