



Full wwPDB X-ray Structure Validation Report ⓘ

Jun 12, 2024 – 12:49 PM EDT

PDB ID : 2XG6
Title : Molecular insights into clinically isolated OmpC mutants and their role in multi-drug resistance
Authors : Lou, H.; Naismith, J.H.
Deposited on : 2010-05-31
Resolution : 3.47 Å(reported)

This is a Full wwPDB X-ray Structure Validation Report for a publicly released PDB entry.

We welcome your comments at validation@mail.wwpdb.org

A user guide is available at

<https://www.wwpdb.org/validation/2017/XrayValidationReportHelp>

with specific help available everywhere you see the ⓘ symbol.

The types of validation reports are described at

<http://www.wwpdb.org/validation/2017/FAQs#types>.

The following versions of software and data (see [references ⓘ](#)) were used in the production of this report:

MolProbity : 4.02b-467
Mogul : 2022.3.0, CSD as543be (2022)
Xtriage (Phenix) : 1.20.1
EDS : 2.36.2
Percentile statistics : 20191225.v01 (using entries in the PDB archive December 25th 2019)
Refmac : 5.8.0158
CCP4 : 7.0.044 (Gargrove)
Ideal geometry (proteins) : Engh & Huber (2001)
Ideal geometry (DNA, RNA) : Parkinson et al. (1996)
Validation Pipeline (wwPDB-VP) : 2.36.2

1 Overall quality at a glance

The following experimental techniques were used to determine the structure:

X-RAY DIFFRACTION

The reported resolution of this entry is 3.47 Å.

Percentile scores (ranging between 0-100) for global validation metrics of the entry are shown in the following graphic. The table shows the number of entries on which the scores are based.

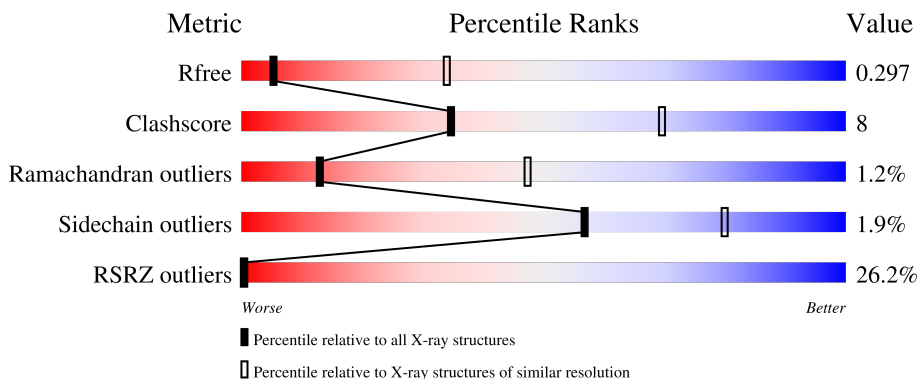

Metric	Whole archive (#Entries)	Similar resolution (#Entries, resolution range(Å))
R_{free}	130704	1379 (3.56-3.40)
Clashscore	141614	1461 (3.56-3.40)
Ramachandran outliers	138981	1424 (3.56-3.40)
Sidechain outliers	138945	1425 (3.56-3.40)
RSRZ outliers	127900	1289 (3.56-3.40)

The table below summarises the geometric issues observed across the polymeric chains and their fit to the electron density. The red, orange, yellow and green segments of the lower bar indicate the fraction of residues that contain outliers for ≥ 3 , 2, 1 and 0 types of geometric quality criteria respectively. A grey segment represents the fraction of residues that are not modelled. The numeric value for each fraction is indicated below the corresponding segment, with a dot representing fractions $\leq 5\%$. The upper red bar (where present) indicates the fraction of residues that have poor fit to the electron density. The numeric value is given above the bar.

Mol	Chain	Length	Quality of chain
1	A	343	
1	B	343	
1	C	343	
1	D	343	
1	E	343	

Continued on next page...

Continued from previous page...

Mol	Chain	Length	Quality of chain
1	F	343	<p>33% 81% 19%</p>

The following table lists non-polymeric compounds, carbohydrate monomers and non-standard residues in protein, DNA, RNA chains that are outliers for geometric or electron-density-fit criteria:

Mol	Type	Chain	Res	Chirality	Geometry	Clashes	Electron density
2	SO4	C	1344	-	-	-	X
2	SO4	D	1344	-	-	-	X

2 Entry composition i

There are 2 unique types of molecules in this entry. The entry contains 16299 atoms, of which 0 are hydrogens and 0 are deuteriums.

In the tables below, the ZeroOcc column contains the number of atoms modelled with zero occupancy, the AltConf column contains the number of residues with at least one atom in alternate conformation and the Trace column contains the number of residues modelled with at most 2 atoms.

- Molecule 1 is a protein called OMPC.

Mol	Chain	Residues	Atoms					ZeroOcc	AltConf	Trace
			Total	C	N	O	S			
1	A	343	2714	1705	451	554	4	0	0	0
1	B	343	2714	1705	451	554	4	0	0	0
1	C	343	2714	1705	451	554	4	0	0	0
1	D	343	2714	1705	451	554	4	0	0	0
1	E	343	2714	1705	451	554	4	0	0	0
1	F	343	2714	1705	451	554	4	0	0	0

There are 18 discrepancies between the modelled and reference sequences:

Chain	Residue	Modelled	Actual	Comment	Reference
A	18	GLU	ASP	SEE REMARK 999	UNP Q9K597
A	124	HIS	ARG	SEE REMARK 999	UNP Q9K597
A	271	PHE	SER	SEE REMARK 999	UNP Q9K597
B	18	GLU	ASP	SEE REMARK 999	UNP Q9K597
B	124	HIS	ARG	SEE REMARK 999	UNP Q9K597
B	271	PHE	SER	SEE REMARK 999	UNP Q9K597
C	18	GLU	ASP	SEE REMARK 999	UNP Q9K597
C	124	HIS	ARG	SEE REMARK 999	UNP Q9K597
C	271	PHE	SER	SEE REMARK 999	UNP Q9K597
D	18	GLU	ASP	SEE REMARK 999	UNP Q9K597
D	124	HIS	ARG	SEE REMARK 999	UNP Q9K597
D	271	PHE	SER	SEE REMARK 999	UNP Q9K597
E	18	GLU	ASP	SEE REMARK 999	UNP Q9K597
E	124	HIS	ARG	SEE REMARK 999	UNP Q9K597
E	271	PHE	SER	SEE REMARK 999	UNP Q9K597
F	18	GLU	ASP	SEE REMARK 999	UNP Q9K597
F	124	HIS	ARG	SEE REMARK 999	UNP Q9K597

Continued on next page...

Continued from previous page...

Chain	Residue	Modelled	Actual	Comment	Reference
F	271	PHE	SER	SEE REMARK 999	UNP Q9K597

- Molecule 2 is SULFATE ION (three-letter code: SO4) (formula: O₄S).

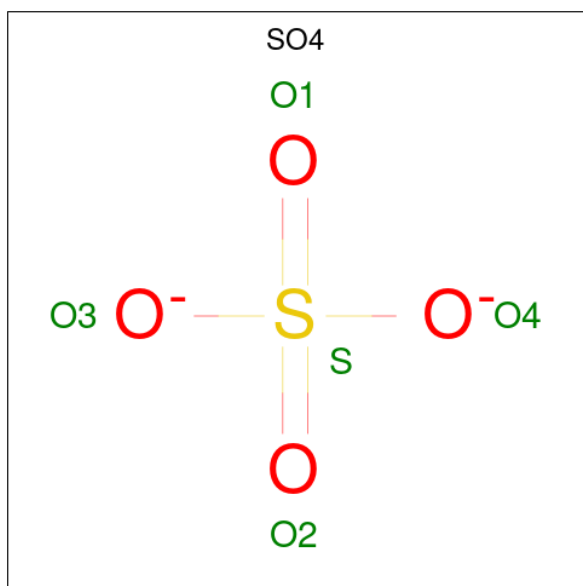

Mol	Chain	Residues	Atoms			ZeroOcc	AltConf
2	A	1	Total	O	S	0	0
			5	4	1		
2	C	1	Total	O	S	0	0
			5	4	1		
2	D	1	Total	O	S	0	0
			5	4	1		

3 Residue-property plots [i](#)

These plots are drawn for all protein, RNA, DNA and oligosaccharide chains in the entry. The first graphic for a chain summarises the proportions of the various outlier classes displayed in the second graphic. The second graphic shows the sequence view annotated by issues in geometry and electron density. Residues are color-coded according to the number of geometric quality criteria for which they contain at least one outlier: green = 0, yellow = 1, orange = 2 and red = 3 or more. A red dot above a residue indicates a poor fit to the electron density ($RSRZ > 2$). Stretches of 2 or more consecutive residues without any outlier are shown as a green connector. Residues present in the sample, but not in the model, are shown in grey.

- Molecule 1: OMPC

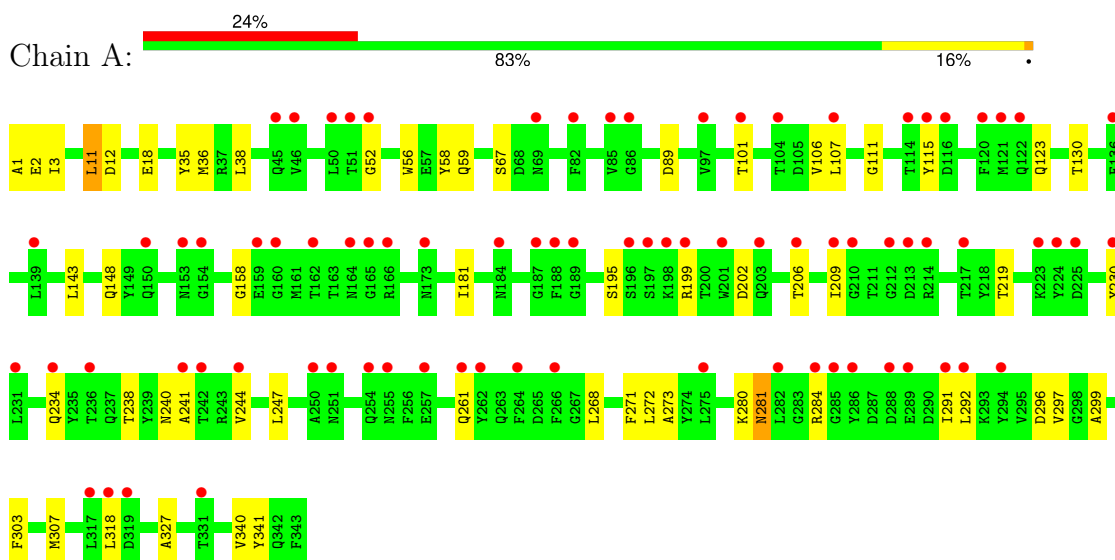

- Molecule 1: OMPC

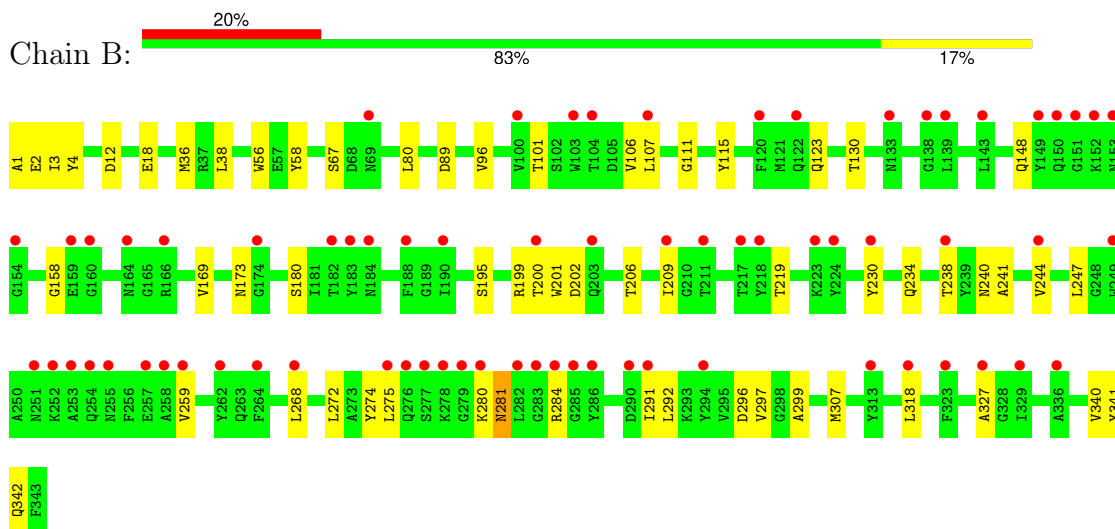

- Molecule 1: OMPC

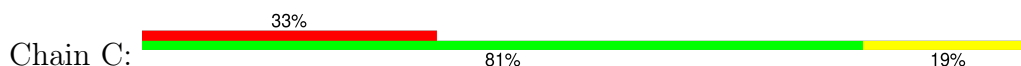

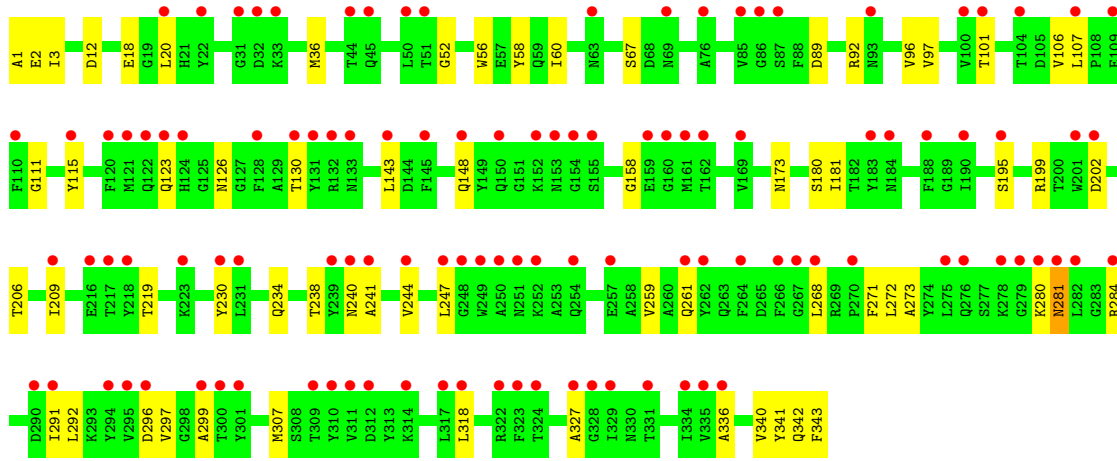

• Molecule 1: OMPC

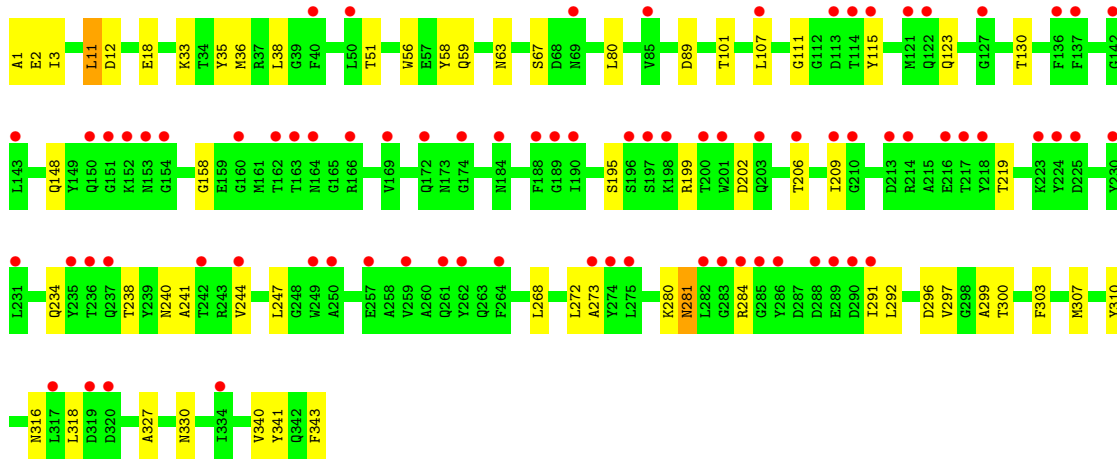
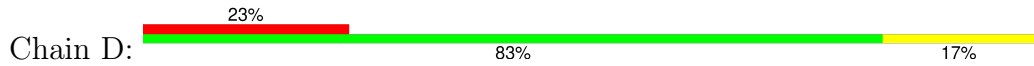

• Molecule 1: OMPC

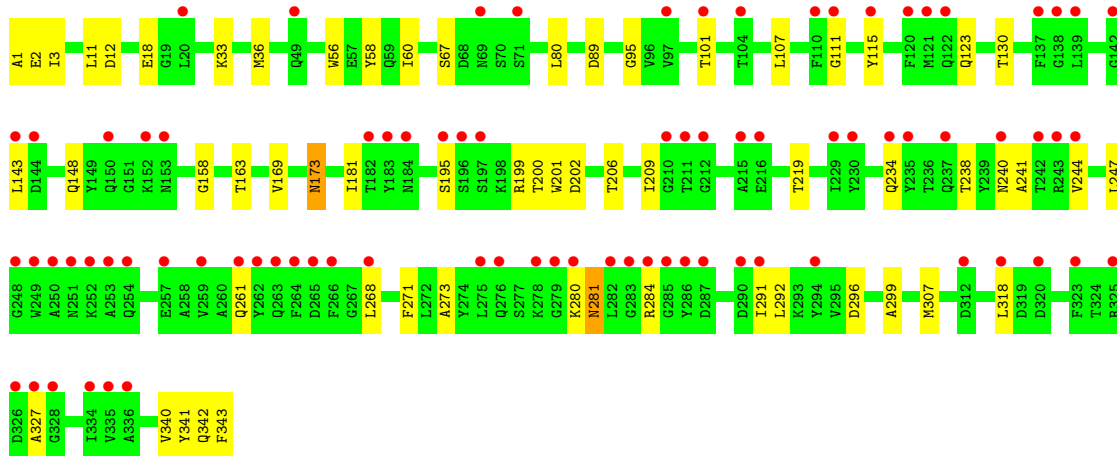
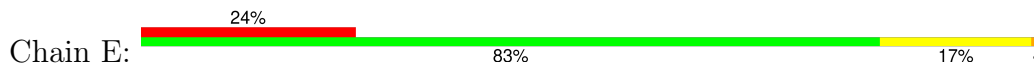

• Molecule 1: OMPC

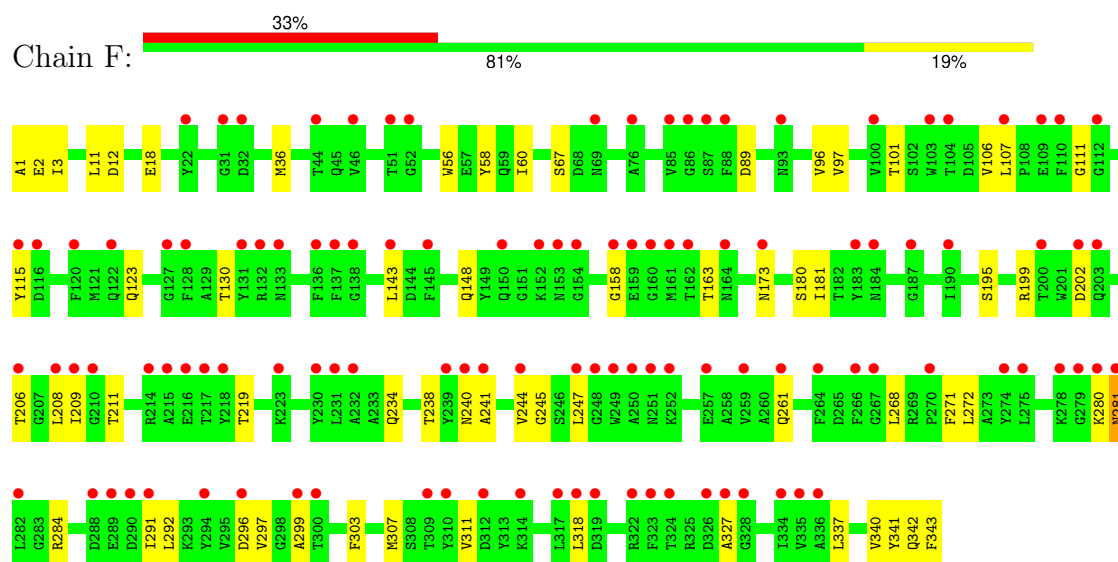

4 Data and refinement statistics i

Property	Value	Source
Space group	P 21 21 21	Depositor
Cell constants a, b, c, α , β , γ	142.82Å 159.72Å 164.60Å 90.00° 90.00° 90.00°	Depositor
Resolution (Å)	53.19 – 3.47 53.19 – 3.47	Depositor EDS
% Data completeness (in resolution range)	82.4 (53.19-3.47) 82.4 (53.19-3.47)	Depositor EDS
R_{merge}	0.11	Depositor
R_{sym}	(Not available)	Depositor
$\langle I/\sigma(I) \rangle$ ¹	1.89 (at 3.48Å)	Xtrriage
Refinement program	REFMAC 5.6.0073	Depositor
R, R_{free}	0.261 , 0.293 0.262 , 0.297	Depositor DCC
R_{free} test set	2053 reflections (5.05%)	wwPDB-VP
Wilson B-factor (Å ²)	121.1	Xtrriage
Anisotropy	0.541	Xtrriage
Bulk solvent k_{sol} (e/Å ³), B_{sol} (Å ²)	0.33 , 133.0	EDS
L-test for twinning ²	$\langle L \rangle = 0.48$, $\langle L^2 \rangle = 0.32$	Xtrriage
Estimated twinning fraction	0.000 for -h,l,k	Xtrriage
F_o, F_c correlation	0.88	EDS
Total number of atoms	16299	wwPDB-VP
Average B, all atoms (Å ²)	53.0	wwPDB-VP

Xtrriage's analysis on translational NCS is as follows: *The analyses of the Patterson function reveals a significant off-origin peak that is 36.10 % of the origin peak, indicating pseudo-translational symmetry. The chance of finding a peak of this or larger height randomly in a structure without pseudo-translational symmetry is equal to 5.2623e-04. The detected translational NCS is most likely also responsible for the elevated intensity ratio.*

¹Intensities estimated from amplitudes.

²Theoretical values of $\langle |L| \rangle$, $\langle L^2 \rangle$ for acentric reflections are 0.5, 0.333 respectively for untwinned datasets, and 0.375, 0.2 for perfectly twinned datasets.

5 Model quality

5.1 Standard geometry

Bond lengths and bond angles in the following residue types are not validated in this section: SO4

The Z score for a bond length (or angle) is the number of standard deviations the observed value is removed from the expected value. A bond length (or angle) with $|Z| > 5$ is considered an outlier worth inspection. RMSZ is the root-mean-square of all Z scores of the bond lengths (or angles).

Mol	Chain	Bond lengths		Bond angles	
		RMSZ	# Z >5	RMSZ	# Z >5
1	A	0.39	0/2777	0.52	0/3758
1	B	0.40	0/2777	0.54	0/3758
1	C	0.38	0/2777	0.52	0/3758
1	D	0.40	0/2777	0.53	0/3758
1	E	0.41	0/2777	0.53	0/3758
1	F	0.37	0/2777	0.52	0/3758
All	All	0.39	0/16662	0.53	0/22548

There are no bond length outliers.

There are no bond angle outliers.

There are no chirality outliers.

There are no planarity outliers.

5.2 Too-close contacts

In the following table, the Non-H and H(model) columns list the number of non-hydrogen atoms and hydrogen atoms in the chain respectively. The H(added) column lists the number of hydrogen atoms added and optimized by MolProbity. The Clashes column lists the number of clashes within the asymmetric unit, whereas Symm-Clashes lists symmetry-related clashes.

Mol	Chain	Non-H	H(model)	H(added)	Clashes	Symm-Clashes
1	A	2714	0	2479	48	0
1	B	2714	0	2479	43	0
1	C	2714	0	2479	51	0
1	D	2714	0	2479	49	0
1	E	2714	0	2479	51	0
1	F	2714	0	2479	52	0
2	A	5	0	0	0	0

Continued on next page...

Continued from previous page...

Mol	Chain	Non-H	H(model)	H(added)	Clashes	Symm-Clashes
2	C	5	0	0	0	0
2	D	5	0	0	0	0
All	All	16299	0	14874	260	0

The all-atom clashscore is defined as the number of clashes found per 1000 atoms (including hydrogen atoms). The all-atom clashscore for this structure is 8.

All (260) close contacts within the same asymmetric unit are listed below, sorted by their clash magnitude.

Atom-1	Atom-2	Interatomic distance (Å)	Clash overlap (Å)
1:C:36:MET:HE3	1:C:60:ILE:HB	1.27	1.16
1:E:130:THR:HG22	1:E:148:GLN:HG3	1.29	1.15
1:B:130:THR:HG22	1:B:148:GLN:HG3	1.32	1.11
1:E:36:MET:HE3	1:E:60:ILE:HB	1.31	1.11
1:F:130:THR:HG22	1:F:148:GLN:HG3	1.32	1.11
1:C:130:THR:HG22	1:C:148:GLN:HG3	1.31	1.11
1:F:36:MET:HE3	1:F:60:ILE:HB	1.21	1.10
1:A:130:THR:HG22	1:A:148:GLN:HG3	1.36	1.04
1:D:130:THR:HG22	1:D:148:GLN:HG3	1.36	1.01
1:F:36:MET:CE	1:F:60:ILE:HB	2.01	0.89
1:C:36:MET:CE	1:C:60:ILE:HB	2.04	0.86
1:C:268:LEU:HD11	1:C:299:ALA:HB1	1.70	0.73
1:C:130:THR:CG2	1:C:148:GLN:HE21	2.01	0.73
1:A:101:THR:HG23	1:A:219:THR:HG21	1.72	0.72
1:F:268:LEU:HD11	1:F:299:ALA:HB1	1.72	0.71
1:F:130:THR:CG2	1:F:148:GLN:HE21	2.05	0.69
1:E:247:LEU:HD12	1:E:327:ALA:HB2	1.74	0.69
1:E:36:MET:HE2	1:F:56:TRP:NE1	2.07	0.69
1:A:268:LEU:HD11	1:A:299:ALA:HB1	1.75	0.69
1:B:130:THR:CG2	1:B:148:GLN:HE21	2.06	0.68
1:E:101:THR:HG23	1:E:219:THR:HG21	1.76	0.68
1:D:101:THR:HG23	1:D:219:THR:HG21	1.76	0.68
1:B:18:GLU:HG3	1:B:340:VAL:HG22	1.76	0.67
1:B:307:MET:HE3	1:C:52:GLY:HA3	1.76	0.67
1:D:56:TRP:NE1	1:F:36:MET:HE2	2.10	0.66
1:D:303:PHE:CZ	1:E:80:LEU:HD11	2.29	0.66
1:B:130:THR:HG22	1:B:148:GLN:CG	2.20	0.66
1:A:130:THR:CG2	1:A:148:GLN:HE21	2.08	0.66
1:C:101:THR:HG23	1:C:219:THR:HG21	1.78	0.65
1:C:130:THR:HG22	1:C:148:GLN:CG	2.19	0.65
1:F:101:THR:HG23	1:F:219:THR:HG21	1.78	0.65

Continued on next page...

Continued from previous page...

Atom-1	Atom-2	Interatomic distance (Å)	Clash overlap (Å)
1:D:18:GLU:HG3	1:D:340:VAL:HG22	1.80	0.64
1:D:307:MET:HE2	1:D:341:TYR:HD1	1.62	0.64
1:C:247:LEU:HD12	1:C:327:ALA:HB2	1.80	0.64
1:E:268:LEU:HD11	1:E:299:ALA:HB1	1.79	0.64
1:D:36:MET:HE3	1:E:56:TRP:CD2	2.33	0.63
1:B:101:THR:HG23	1:B:219:THR:HG21	1.80	0.63
1:A:56:TRP:NE1	1:C:36:MET:HE2	2.14	0.63
1:F:36:MET:HE1	1:F:60:ILE:HD12	1.80	0.63
1:D:247:LEU:HD12	1:D:327:ALA:HB2	1.81	0.62
1:C:130:THR:CG2	1:C:148:GLN:HG3	2.19	0.62
1:F:307:MET:HE2	1:F:341:TYR:HD1	1.62	0.62
1:C:107:LEU:HD12	1:C:111:GLY:HA3	1.81	0.62
1:E:130:THR:CG2	1:E:148:GLN:HE21	2.13	0.62
1:E:18:GLU:HG3	1:E:340:VAL:HG22	1.80	0.61
1:E:130:THR:CG2	1:E:148:GLN:HG3	2.19	0.61
1:E:36:MET:CE	1:E:60:ILE:HB	2.19	0.61
1:A:36:MET:HE3	1:B:56:TRP:CD2	2.35	0.61
1:B:247:LEU:HD12	1:B:327:ALA:HB2	1.83	0.61
1:D:3:ILE:HD13	1:E:3:ILE:HD12	1.81	0.61
1:B:107:LEU:HD12	1:B:111:GLY:HA3	1.82	0.61
1:D:292:LEU:HD12	1:D:318:LEU:HD11	1.82	0.61
1:D:1:ALA:N	1:D:12:ASP:OD1	2.29	0.60
1:D:107:LEU:HD12	1:D:111:GLY:HA3	1.83	0.60
1:D:130:THR:CG2	1:D:148:GLN:HE21	2.14	0.60
1:A:307:MET:HE2	1:A:341:TYR:HD1	1.67	0.59
1:D:268:LEU:HD11	1:D:299:ALA:HB1	1.85	0.59
1:E:107:LEU:HD12	1:E:111:GLY:HA3	1.85	0.58
1:A:247:LEU:HD12	1:A:327:ALA:HB2	1.85	0.58
1:F:36:MET:HE3	1:F:60:ILE:CB	2.15	0.58
1:E:130:THR:HG22	1:E:148:GLN:CG	2.20	0.58
1:E:36:MET:CE	1:F:56:TRP:NE1	2.67	0.57
1:F:209:ILE:CG2	1:F:284:ARG:HD3	2.34	0.57
1:B:130:THR:CG2	1:B:148:GLN:HG3	2.21	0.57
1:C:209:ILE:CG2	1:C:284:ARG:HD3	2.35	0.57
1:D:209:ILE:CG2	1:D:284:ARG:HD3	2.34	0.57
1:F:130:THR:HG22	1:F:148:GLN:CG	2.21	0.57
1:C:18:GLU:HG3	1:C:340:VAL:HG22	1.87	0.57
1:A:107:LEU:HD12	1:A:111:GLY:HA3	1.87	0.57
1:A:209:ILE:CG2	1:A:284:ARG:HD3	2.35	0.56
1:C:130:THR:HG21	1:C:148:GLN:HE21	1.68	0.56
1:B:209:ILE:CG2	1:B:284:ARG:HD3	2.36	0.56

Continued on next page...

Continued from previous page...

Atom-1	Atom-2	Interatomic distance (Å)	Clash overlap (Å)
1:E:209:ILE:CG2	1:E:284:ARG:HD3	2.36	0.56
1:B:36:MET:HE2	1:B:38:LEU:HB2	1.87	0.56
1:A:35:TYR:CD2	1:A:59:GLN:NE2	2.73	0.56
1:C:106:VAL:HG11	1:C:230:TYR:CE2	2.41	0.56
1:E:1:ALA:O	1:E:3:ILE:HG23	2.05	0.56
1:F:292:LEU:HD12	1:F:318:LEU:HD11	1.88	0.55
1:D:11:LEU:HD13	1:F:343:PHE:CD2	2.41	0.55
1:A:18:GLU:HG3	1:A:340:VAL:HG22	1.87	0.55
1:D:130:THR:HG22	1:D:148:GLN:CG	2.25	0.55
1:F:130:THR:CG2	1:F:148:GLN:HG3	2.21	0.55
1:A:292:LEU:HD12	1:A:318:LEU:HD11	1.88	0.55
1:F:130:THR:HG21	1:F:148:GLN:HE21	1.71	0.54
1:A:130:THR:HG22	1:A:148:GLN:CG	2.24	0.54
1:D:80:LEU:HD11	1:F:303:PHE:CZ	2.43	0.54
1:B:307:MET:HE3	1:C:52:GLY:CA	2.36	0.54
1:F:18:GLU:HG3	1:F:340:VAL:HG22	1.89	0.54
1:F:130:THR:HG22	1:F:148:GLN:HE21	1.73	0.54
1:A:130:THR:HG22	1:A:148:GLN:HE21	1.72	0.53
1:C:130:THR:HG22	1:C:148:GLN:HE21	1.74	0.53
1:D:35:TYR:CD2	1:D:59:GLN:NE2	2.77	0.53
1:A:272:LEU:HD13	1:A:297:VAL:CG2	2.40	0.52
1:C:36:MET:HE1	1:C:60:ILE:HD12	1.91	0.52
1:F:247:LEU:HD12	1:F:327:ALA:HB2	1.89	0.52
1:A:244:VAL:HG22	1:A:291:ILE:HD13	1.92	0.52
1:B:274:TYR:C	1:B:275:LEU:HD12	2.31	0.52
1:D:202:ASP:O	1:D:206:THR:HG23	2.10	0.52
1:C:143:LEU:HD11	1:C:181:ILE:HG23	1.91	0.51
1:B:292:LEU:HA	1:B:318:LEU:HD11	1.90	0.51
1:B:244:VAL:HG22	1:B:291:ILE:HD13	1.92	0.51
1:A:272:LEU:HD13	1:A:297:VAL:HG22	1.93	0.51
1:C:106:VAL:CG2	1:C:259:VAL:HG11	2.41	0.51
1:F:107:LEU:HD12	1:F:111:GLY:HA3	1.92	0.51
1:B:130:THR:HG21	1:B:148:GLN:HE21	1.74	0.51
1:A:1:ALA:O	1:A:3:ILE:HG23	2.11	0.51
1:B:2:GLU:HA	1:B:12:ASP:HA	1.92	0.51
1:F:202:ASP:O	1:F:206:THR:HG23	2.11	0.51
1:A:202:ASP:O	1:A:206:THR:HG23	2.11	0.51
1:E:2:GLU:HA	1:E:12:ASP:HA	1.92	0.51
1:C:202:ASP:O	1:C:206:THR:HG23	2.10	0.50
1:D:272:LEU:HD13	1:D:297:VAL:CG2	2.41	0.50
1:D:272:LEU:HD13	1:D:297:VAL:HG22	1.93	0.50

Continued on next page...

Continued from previous page...

Atom-1	Atom-2	Interatomic distance (Å)	Clash overlap (Å)
1:E:202:ASP:O	1:E:206:THR:HG23	2.11	0.50
1:F:2:GLU:HA	1:F:12:ASP:HA	1.93	0.50
1:B:130:THR:HG22	1:B:148:GLN:HE21	1.76	0.50
1:A:2:GLU:HA	1:A:12:ASP:HA	1.94	0.50
1:B:202:ASP:O	1:B:206:THR:HG23	2.12	0.50
1:D:199:ARG:NH1	1:D:240:ASN:O	2.45	0.50
1:B:307:MET:HE2	1:B:341:TYR:HD1	1.77	0.49
1:D:2:GLU:HA	1:D:12:ASP:HA	1.95	0.49
1:D:244:VAL:HG22	1:D:291:ILE:HD13	1.95	0.49
1:E:199:ARG:NH1	1:E:240:ASN:O	2.46	0.49
1:A:199:ARG:NH1	1:A:240:ASN:O	2.45	0.49
1:D:130:THR:HG22	1:D:148:GLN:HE21	1.76	0.49
1:B:199:ARG:NH1	1:B:240:ASN:O	2.46	0.49
1:C:199:ARG:NH1	1:C:240:ASN:O	2.46	0.49
1:A:143:LEU:HD11	1:A:181:ILE:HG23	1.94	0.49
1:C:2:GLU:HA	1:C:12:ASP:HA	1.94	0.49
1:D:56:TRP:CZ2	1:F:36:MET:HE1	2.47	0.49
1:E:143:LEU:HD11	1:E:181:ILE:HG23	1.94	0.48
1:A:130:THR:HG21	1:A:148:GLN:HE21	1.79	0.48
1:B:272:LEU:HD13	1:B:297:VAL:HG22	1.96	0.48
1:A:36:MET:HE2	1:A:38:LEU:HB2	1.95	0.48
1:C:272:LEU:HD13	1:C:297:VAL:CG2	2.43	0.48
1:F:199:ARG:NH1	1:F:240:ASN:O	2.46	0.48
1:B:209:ILE:HG23	1:B:284:ARG:HH11	1.79	0.48
1:D:209:ILE:HG23	1:D:284:ARG:HH11	1.79	0.48
1:D:33:LYS:HD3	1:E:163:THR:HG21	1.96	0.48
1:B:106:VAL:HG11	1:B:230:TYR:CE2	2.48	0.47
1:E:36:MET:HE1	1:F:56:TRP:CZ2	2.48	0.47
1:F:209:ILE:HG23	1:F:284:ARG:HH11	1.79	0.47
1:E:36:MET:HE1	1:F:56:TRP:CE2	2.48	0.47
1:E:247:LEU:CD1	1:E:327:ALA:HB2	2.44	0.47
1:B:268:LEU:HD11	1:B:299:ALA:HB1	1.96	0.47
1:E:209:ILE:HG23	1:E:284:ARG:HH11	1.80	0.47
1:C:209:ILE:HG23	1:C:284:ARG:HH11	1.80	0.47
1:D:107:LEU:HD13	1:D:296:ASP:OD2	2.14	0.47
1:E:36:MET:HE1	1:E:60:ILE:HD12	1.97	0.47
1:E:307:MET:HE1	1:E:341:TYR:HB2	1.95	0.47
1:F:56:TRP:CZ2	1:F:58:TYR:HB2	2.50	0.47
1:F:238:THR:HB	1:F:241:ALA:HB3	1.95	0.47
1:B:1:ALA:O	1:B:3:ILE:HG23	2.14	0.47
1:E:56:TRP:CZ2	1:E:58:TYR:HB2	2.50	0.47

Continued on next page...

Continued from previous page...

Atom-1	Atom-2	Interatomic distance (Å)	Clash overlap (Å)
1:F:307:MET:HE2	1:F:341:TYR:CD1	2.47	0.47
1:E:33:LYS:HD3	1:F:163:THR:HG21	1.96	0.47
1:C:56:TRP:CZ2	1:C:58:TYR:HB2	2.50	0.46
1:D:1:ALA:O	1:D:3:ILE:HG23	2.15	0.46
1:C:92:ARG:HD2	1:C:126:ASN:ND2	2.31	0.46
1:A:268:LEU:HD11	1:A:299:ALA:CB	2.45	0.46
1:F:96:VAL:HG22	1:F:180:SER:HB3	1.98	0.46
1:A:52:GLY:HA3	1:C:307:MET:HE3	1.98	0.46
1:A:1:ALA:HB1	1:B:4:TYR:CE1	2.51	0.46
1:A:209:ILE:HG23	1:A:284:ARG:HH11	1.79	0.46
1:B:56:TRP:CZ2	1:B:58:TYR:HB2	2.51	0.46
1:A:101:THR:HG22	1:A:234:GLN:OE1	2.16	0.45
1:A:238:THR:HB	1:A:241:ALA:HB3	1.97	0.45
1:D:36:MET:HE2	1:D:38:LEU:HB2	1.97	0.45
1:A:3:ILE:HD13	1:B:3:ILE:HD12	1.98	0.45
1:A:56:TRP:CZ2	1:A:58:TYR:HB2	2.51	0.45
1:F:272:LEU:HD13	1:F:297:VAL:HG22	1.99	0.45
1:B:36:MET:HE3	1:C:56:TRP:CD2	2.52	0.45
1:D:56:TRP:NE1	1:F:36:MET:CE	2.78	0.45
1:E:101:THR:HG22	1:E:234:GLN:OE1	2.16	0.45
1:F:1:ALA:O	1:F:3:ILE:HG23	2.15	0.45
1:C:107:LEU:HD13	1:C:296:ASP:OD2	2.17	0.45
1:D:130:THR:HG21	1:D:148:GLN:HE21	1.82	0.45
1:A:106:VAL:HG11	1:A:230:TYR:CE2	2.51	0.45
1:A:307:MET:HE2	1:A:341:TYR:CD1	2.50	0.45
1:E:36:MET:CE	1:F:56:TRP:CE2	3.00	0.45
1:B:106:VAL:CG2	1:B:259:VAL:HG11	2.47	0.45
1:B:272:LEU:HD13	1:B:297:VAL:CG2	2.47	0.45
1:C:238:THR:HB	1:C:241:ALA:HB3	1.97	0.45
1:D:300:THR:HG23	1:D:310:TYR:HB3	1.99	0.45
1:D:307:MET:HE2	1:D:341:TYR:CD1	2.46	0.44
1:E:107:LEU:HD13	1:E:296:ASP:OD2	2.17	0.44
1:E:95:GLY:HA2	1:E:148:GLN:HE22	1.82	0.44
1:C:101:THR:HG22	1:C:234:GLN:OE1	2.17	0.44
1:F:272:LEU:HD13	1:F:297:VAL:CG2	2.48	0.44
1:B:107:LEU:HD13	1:B:296:ASP:OD2	2.17	0.44
1:A:11:LEU:HD13	1:C:343:PHE:CD2	2.53	0.44
1:D:238:THR:HB	1:D:241:ALA:HB3	1.98	0.44
1:C:272:LEU:HD13	1:C:297:VAL:HG22	1.99	0.44
1:A:307:MET:CE	1:A:341:TYR:HD1	2.30	0.44
1:D:107:LEU:HD21	1:D:273:ALA:HB2	2.00	0.44

Continued on next page...

Continued from previous page...

Atom-1	Atom-2	Interatomic distance (Å)	Clash overlap (Å)
1:A:107:LEU:HD13	1:A:296:ASP:OD2	2.18	0.43
1:B:101:THR:HG22	1:B:234:GLN:OE1	2.18	0.43
1:E:343:PHE:CG	1:F:11:LEU:HD13	2.52	0.43
1:C:107:LEU:HD21	1:C:273:ALA:HB2	2.01	0.43
1:D:280:LYS:O	1:D:281:ASN:C	2.56	0.43
1:F:107:LEU:HD13	1:F:296:ASP:OD2	2.19	0.43
1:A:268:LEU:CD1	1:A:299:ALA:HB1	2.47	0.43
1:C:244:VAL:HG22	1:C:291:ILE:HD13	2.01	0.43
1:C:280:LYS:O	1:C:281:ASN:C	2.56	0.43
1:D:36:MET:HE3	1:E:56:TRP:CE3	2.53	0.43
1:D:56:TRP:CZ2	1:D:58:TYR:HB2	2.53	0.43
1:A:303:PHE:CZ	1:B:80:LEU:HD11	2.54	0.43
1:A:107:LEU:HD21	1:A:273:ALA:HB2	2.01	0.43
1:F:101:THR:HG22	1:F:234:GLN:OE1	2.18	0.43
1:A:280:LYS:O	1:A:281:ASN:C	2.57	0.43
1:D:56:TRP:CE2	1:F:36:MET:CE	3.01	0.43
1:F:244:VAL:HG22	1:F:291:ILE:HD13	2.01	0.42
1:C:20:LEU:HD11	1:C:336:ALA:HB1	2.01	0.42
1:E:238:THR:HB	1:E:241:ALA:HB3	2.00	0.42
1:E:280:LYS:O	1:E:281:ASN:C	2.57	0.42
1:D:268:LEU:CD1	1:D:299:ALA:HB1	2.49	0.42
1:F:280:LYS:O	1:F:281:ASN:C	2.57	0.42
1:D:343:PHE:CG	1:E:11:LEU:HD13	2.55	0.42
1:A:36:MET:HE3	1:B:56:TRP:CE3	2.54	0.42
1:A:130:THR:CG2	1:A:148:GLN:HG3	2.27	0.42
1:E:107:LEU:HD21	1:E:273:ALA:HB2	2.01	0.42
1:F:143:LEU:HD11	1:F:181:ILE:HG23	2.02	0.42
1:A:52:GLY:CA	1:C:307:MET:HE3	2.49	0.42
1:C:1:ALA:N	1:C:12:ASP:OD1	2.49	0.42
1:C:1:ALA:O	1:C:3:ILE:HG23	2.19	0.42
1:E:292:LEU:HA	1:E:318:LEU:HD11	2.00	0.42
1:C:96:VAL:HG22	1:C:180:SER:HB3	2.01	0.42
1:E:130:THR:HG21	1:E:148:GLN:HE21	1.84	0.42
1:F:261:GLN:HG2	1:F:271:PHE:HB3	2.02	0.42
1:B:280:LYS:O	1:B:281:ASN:C	2.58	0.41
1:B:96:VAL:HG22	1:B:180:SER:HB3	2.02	0.41
1:F:311:VAL:HG22	1:F:337:LEU:HD13	2.01	0.41
1:D:292:LEU:HA	1:D:318:LEU:HD11	2.01	0.41
1:B:200:THR:HG22	1:B:201:TRP:N	2.35	0.41
1:C:292:LEU:HD12	1:C:318:LEU:HD11	2.02	0.41
1:C:307:MET:HE1	1:C:341:TYR:HB2	2.00	0.41

Continued on next page...

Continued from previous page...

Atom-1	Atom-2	Interatomic distance (Å)	Clash overlap (Å)
1:A:261:GLN:HG2	1:A:271:PHE:HB3	2.03	0.41
1:B:238:THR:HB	1:B:241:ALA:HB3	2.02	0.41
1:C:261:GLN:HG2	1:C:271:PHE:HB3	2.03	0.41
1:D:33:LYS:HA	1:D:63:ASN:HD22	1.86	0.41
1:D:101:THR:HG22	1:D:234:GLN:OE1	2.20	0.41
1:E:200:THR:HG22	1:E:201:TRP:N	2.36	0.41
1:D:316:ASN:ND2	1:D:330:ASN:O	2.53	0.41
1:B:169:VAL:HG21	1:B:206:THR:HG21	2.03	0.41
1:C:268:LEU:HD11	1:C:299:ALA:CB	2.46	0.41
1:C:268:LEU:CD1	1:C:299:ALA:HB1	2.47	0.41
1:E:244:VAL:HG22	1:E:291:ILE:HD13	2.03	0.41
1:F:106:VAL:HG23	1:F:261:GLN:NE2	2.36	0.41
1:E:1:ALA:N	1:E:12:ASP:OD1	2.50	0.41
1:F:208:LEU:O	1:F:211:THR:HG23	2.22	0.41
1:C:292:LEU:HA	1:C:318:LEU:HD11	2.01	0.40
1:E:261:GLN:HG2	1:E:271:PHE:HB3	2.03	0.40
1:D:303:PHE:CZ	1:E:80:LEU:CD1	3.00	0.40
1:E:169:VAL:HG21	1:E:206:THR:HG21	2.03	0.40
1:A:56:TRP:NE1	1:C:36:MET:CE	2.84	0.40
1:E:173:ASN:HD22	1:E:173:ASN:C	2.24	0.40
1:E:292:LEU:HD12	1:E:318:LEU:HD11	2.02	0.40
1:A:1:ALA:N	1:A:12:ASP:OD1	2.49	0.40
1:B:307:MET:HE3	1:C:52:GLY:C	2.42	0.40
1:F:245:GLY:HA3	1:F:327:ALA:HB1	2.02	0.40

There are no symmetry-related clashes.

5.3 Torsion angles [\(i\)](#)

5.3.1 Protein backbone [\(i\)](#)

In the following table, the Percentiles column shows the percent Ramachandran outliers of the chain as a percentile score with respect to all X-ray entries followed by that with respect to entries of similar resolution.

The Analysed column shows the number of residues for which the backbone conformation was analysed, and the total number of residues.

Mol	Chain	Analysed	Favoured	Allowed	Outliers	Percentiles
1	A	341/343 (99%)	310 (91%)	27 (8%)	4 (1%)	13 47

Continued on next page...

Continued from previous page...

Mol	Chain	Analysed	Favoured	Allowed	Outliers	Percentiles	
1	B	341/343 (99%)	307 (90%)	30 (9%)	4 (1%)	13	47
1	C	341/343 (99%)	309 (91%)	28 (8%)	4 (1%)	13	47
1	D	341/343 (99%)	310 (91%)	27 (8%)	4 (1%)	13	47
1	E	341/343 (99%)	310 (91%)	27 (8%)	4 (1%)	13	47
1	F	341/343 (99%)	310 (91%)	27 (8%)	4 (1%)	13	47
All	All	2046/2058 (99%)	1856 (91%)	166 (8%)	24 (1%)	13	47

All (24) Ramachandran outliers are listed below:

Mol	Chain	Res	Type
1	A	281	ASN
1	B	281	ASN
1	C	281	ASN
1	D	281	ASN
1	E	281	ASN
1	F	281	ASN
1	A	158	GLY
1	B	158	GLY
1	C	158	GLY
1	D	158	GLY
1	E	158	GLY
1	F	158	GLY
1	A	67	SER
1	B	67	SER
1	C	67	SER
1	D	67	SER
1	F	67	SER
1	A	123	GLN
1	B	123	GLN
1	C	123	GLN
1	D	123	GLN
1	E	67	SER
1	E	123	GLN
1	F	123	GLN

5.3.2 Protein sidechains [i](#)

In the following table, the Percentiles column shows the percent sidechain outliers of the chain as a percentile score with respect to all X-ray entries followed by that with respect to entries of similar resolution.

The Analysed column shows the number of residues for which the sidechain conformation was analysed, and the total number of residues.

Mol	Chain	Analysed	Rotameric	Outliers	Percentiles	
1	A	277/277 (100%)	273 (99%)	4 (1%)	67	85
1	B	277/277 (100%)	272 (98%)	5 (2%)	59	81
1	C	277/277 (100%)	271 (98%)	6 (2%)	52	77
1	D	277/277 (100%)	272 (98%)	5 (2%)	59	81
1	E	277/277 (100%)	272 (98%)	5 (2%)	59	81
1	F	277/277 (100%)	271 (98%)	6 (2%)	52	77
All	All	1662/1662 (100%)	1631 (98%)	31 (2%)	57	80

All (31) residues with a non-rotameric sidechain are listed below:

Mol	Chain	Res	Type
1	A	11	LEU
1	A	89	ASP
1	A	115	TYR
1	A	195	SER
1	B	89	ASP
1	B	115	TYR
1	B	173	ASN
1	B	195	SER
1	B	342	GLN
1	C	89	ASP
1	C	97	VAL
1	C	115	TYR
1	C	173	ASN
1	C	195	SER
1	C	342	GLN
1	D	11	LEU
1	D	51	THR
1	D	89	ASP
1	D	115	TYR
1	D	195	SER
1	E	89	ASP
1	E	115	TYR
1	E	173	ASN
1	E	195	SER
1	E	342	GLN
1	F	89	ASP
1	F	97	VAL

Continued on next page...

Continued from previous page...

Mol	Chain	Res	Type
1	F	115	TYR
1	F	173	ASN
1	F	195	SER
1	F	342	GLN

Sometimes sidechains can be flipped to improve hydrogen bonding and reduce clashes. All (5) such sidechains are listed below:

Mol	Chain	Res	Type
1	B	119	ASN
1	B	173	ASN
1	D	119	ASN
1	E	150	GLN
1	E	173	ASN

5.3.3 RNA [i](#)

There are no RNA molecules in this entry.

5.4 Non-standard residues in protein, DNA, RNA chains [i](#)

There are no non-standard protein/DNA/RNA residues in this entry.

5.5 Carbohydrates [i](#)

There are no monosaccharides in this entry.

5.6 Ligand geometry [i](#)

3 ligands are modelled in this entry.

In the following table, the Counts columns list the number of bonds (or angles) for which Mogul statistics could be retrieved, the number of bonds (or angles) that are observed in the model and the number of bonds (or angles) that are defined in the Chemical Component Dictionary. The Link column lists molecule types, if any, to which the group is linked. The Z score for a bond length (or angle) is the number of standard deviations the observed value is removed from the expected value. A bond length (or angle) with $|Z| > 2$ is considered an outlier worth inspection. RMSZ is the root-mean-square of all Z scores of the bond lengths (or angles).

Mol	Type	Chain	Res	Link	Bond lengths			Bond angles		
					Counts	RMSZ	# Z > 2	Counts	RMSZ	# Z > 2
2	SO4	C	1344	-	4,4,4	0.25	0	6,6,6	0.16	0
2	SO4	D	1344	-	4,4,4	0.26	0	6,6,6	0.22	0
2	SO4	A	1344	-	4,4,4	0.24	0	6,6,6	0.16	0

There are no bond length outliers.

There are no bond angle outliers.

There are no chirality outliers.

There are no torsion outliers.

There are no ring outliers.

No monomer is involved in short contacts.

5.7 Other polymers [i](#)

There are no such residues in this entry.

5.8 Polymer linkage issues [i](#)

There are no chain breaks in this entry.

6 Fit of model and data

6.1 Protein, DNA and RNA chains

In the following table, the column labelled ‘#RSRZ> 2’ contains the number (and percentage) of RSRZ outliers, followed by percent RSRZ outliers for the chain as percentile scores relative to all X-ray entries and entries of similar resolution. The OWAB column contains the minimum, median, 95th percentile and maximum values of the occupancy-weighted average B-factor per residue. The column labelled ‘Q< 0.9’ lists the number of (and percentage) of residues with an average occupancy less than 0.9.

Mol	Chain	Analysed	<RSRZ>	#RSRZ>2	OWAB(Å ²)	Q<0.9
1	A	343/343 (100%)	1.33	81 (23%) 0 0	19, 49, 77, 95	0
1	B	343/343 (100%)	1.18	70 (20%) 1 1	10, 47, 73, 87	0
1	C	343/343 (100%)	1.62	112 (32%) 0 0	27, 61, 85, 131	0
1	D	343/343 (100%)	1.30	79 (23%) 0 0	20, 50, 74, 87	0
1	E	343/343 (100%)	1.37	83 (24%) 0 0	14, 46, 74, 96	0
1	F	343/343 (100%)	1.79	114 (33%) 0 0	30, 61, 84, 115	0
All	All	2058/2058 (100%)	1.43	539 (26%) 0 0	10, 53, 80, 131	0

All (539) RSRZ outliers are listed below:

Mol	Chain	Res	Type	RSRZ
1	F	160	GLY	21.1
1	C	290	ASP	15.5
1	F	86	GLY	13.4
1	F	319	ASP	12.0
1	C	160	GLY	10.3
1	F	87	SER	9.7
1	F	159	GLU	9.7
1	F	250	ALA	9.5
1	C	159	GLU	9.4
1	F	318	LEU	8.5
1	A	224	TYR	8.2
1	C	291	ILE	8.2
1	F	249	TRP	7.7
1	F	323	PHE	7.5
1	F	280	LYS	7.3
1	F	131	TYR	7.0
1	C	249	TRP	6.7
1	C	122	GLN	6.5
1	C	328	GLY	6.5

Continued on next page...

Continued from previous page...

Mol	Chain	Res	Type	RSRZ
1	A	122	GLN	6.5
1	E	262	TYR	6.5
1	F	279	GLY	6.4
1	F	31	GLY	6.4
1	D	203	GLN	6.3
1	E	196	SER	6.2
1	E	285	GLY	6.1
1	F	289	GLU	6.1
1	F	161	MET	5.9
1	F	336	ALA	5.8
1	F	247	LEU	5.8
1	A	188	PHE	5.7
1	F	296	ASP	5.7
1	F	52	GLY	5.6
1	E	280	LYS	5.6
1	C	217	THR	5.6
1	E	291	ILE	5.6
1	F	162	THR	5.6
1	C	86	GLY	5.6
1	F	278	LYS	5.5
1	B	285	GLY	5.5
1	C	318	LEU	5.5
1	C	162	THR	5.4
1	F	334	ILE	5.4
1	C	154	GLY	5.4
1	D	122	GLN	5.3
1	D	242	THR	5.3
1	E	290	ASP	5.3
1	D	184	ASN	5.2
1	F	120	PHE	5.2
1	B	160	GLY	5.2
1	C	280	LYS	5.2
1	E	182	THR	5.2
1	A	210	GLY	5.2
1	C	247	LEU	5.2
1	C	110	PHE	5.2
1	F	240	ASN	5.1
1	E	252	LYS	5.1
1	D	213	ASP	5.1
1	D	286	TYR	5.0
1	F	312	ASP	4.9
1	D	164	ASN	4.9

Continued on next page...

Continued from previous page...

Mol	Chain	Res	Type	RSRZ
1	B	184	ASN	4.9
1	A	164	ASN	4.8
1	A	319	ASP	4.8
1	E	197	SER	4.8
1	F	154	GLY	4.8
1	D	153	ASN	4.8
1	A	187	GLY	4.7
1	A	160	GLY	4.7
1	A	52	GLY	4.6
1	F	275	LEU	4.6
1	F	281	ASN	4.6
1	D	154	GLY	4.6
1	A	203	GLN	4.6
1	C	278	LYS	4.6
1	C	317	LEU	4.6
1	C	85	VAL	4.6
1	A	154	GLY	4.5
1	A	251	ASN	4.5
1	F	282	LEU	4.5
1	C	327	ALA	4.5
1	F	122	GLN	4.5
1	F	291	ILE	4.5
1	E	212	GLY	4.4
1	F	46	VAL	4.4
1	C	294	TYR	4.4
1	E	122	GLN	4.4
1	A	214	ARG	4.4
1	C	266	PHE	4.4
1	E	275	LEU	4.4
1	A	197	SER	4.4
1	C	336	ALA	4.4
1	E	278	LYS	4.4
1	F	290	ASP	4.3
1	A	121	MET	4.3
1	C	101	THR	4.3
1	B	139	LEU	4.3
1	D	285	GLY	4.3
1	D	209	ILE	4.2
1	F	136	PHE	4.2
1	E	326	ASP	4.2
1	C	104	THR	4.2
1	F	209	ILE	4.2

Continued on next page...

Continued from previous page...

Mol	Chain	Res	Type	RSRZ
1	D	283	GLY	4.2
1	E	253	ALA	4.2
1	D	150	GLN	4.2
1	B	327	ALA	4.1
1	C	133	ASN	4.1
1	C	143	LEU	4.1
1	A	50	LEU	4.1
1	A	285	GLY	4.1
1	C	183	TYR	4.1
1	C	251	ASN	4.1
1	B	318	LEU	4.1
1	D	275	LEU	4.0
1	B	100	VAL	4.0
1	C	334	ILE	4.0
1	F	217	THR	4.0
1	E	120	PHE	4.0
1	C	244	VAL	4.0
1	D	261	GLN	4.0
1	A	159	GLU	4.0
1	F	324	THR	4.0
1	A	184	ASN	4.0
1	B	122	GLN	4.0
1	C	132	ARG	4.0
1	B	279	GLY	4.0
1	B	280	LYS	4.0
1	B	253	ALA	3.9
1	C	312	ASP	3.9
1	C	323	PHE	3.9
1	A	291	ILE	3.9
1	F	241	ALA	3.9
1	E	264	PHE	3.9
1	C	87	SER	3.9
1	D	291	ILE	3.9
1	E	216	GLU	3.8
1	E	279	GLY	3.8
1	A	286	TYR	3.8
1	A	162	THR	3.8
1	E	143	LEU	3.8
1	A	85	VAL	3.7
1	D	214	ARG	3.7
1	A	318	LEU	3.7
1	C	252	LYS	3.7

Continued on next page...

Continued from previous page...

Mol	Chain	Res	Type	RSRZ
1	A	212	GLY	3.7
1	F	103	TRP	3.7
1	F	143	LEU	3.7
1	B	294	TYR	3.7
1	D	218	TYR	3.7
1	D	206	THR	3.7
1	C	248	GLY	3.7
1	A	284	ARG	3.7
1	F	261	GLN	3.7
1	F	104	THR	3.6
1	F	251	ASN	3.6
1	C	282	LEU	3.6
1	B	278	LYS	3.6
1	E	294	TYR	3.6
1	D	249	TRP	3.6
1	F	216	GLU	3.6
1	B	275	LEU	3.6
1	A	289	GLU	3.6
1	C	262	TYR	3.6
1	C	240	ASN	3.6
1	E	251	ASN	3.6
1	C	121	MET	3.6
1	E	121	MET	3.6
1	E	249	TRP	3.5
1	D	160	GLY	3.5
1	B	251	ASN	3.5
1	D	290	ASP	3.5
1	B	291	ILE	3.5
1	A	261	GLN	3.5
1	B	282	LEU	3.5
1	F	299	ALA	3.5
1	D	230	TYR	3.5
1	B	255	ASN	3.5
1	F	335	VAL	3.5
1	D	237	GLN	3.5
1	E	242	THR	3.5
1	E	183	TYR	3.4
1	F	314	LYS	3.4
1	C	184	ASN	3.4
1	C	123	GLN	3.4
1	F	85	VAL	3.4
1	B	182	THR	3.4

Continued on next page...

Continued from previous page...

Mol	Chain	Res	Type	RSRZ
1	F	317	LEU	3.4
1	C	322	ARG	3.4
1	B	69	ASN	3.4
1	E	250	ALA	3.4
1	C	209	ILE	3.4
1	C	131	TYR	3.4
1	C	190	ILE	3.4
1	C	45	GLN	3.4
1	C	51	THR	3.4
1	D	201	TRP	3.3
1	F	183	TYR	3.3
1	A	225	ASP	3.3
1	C	296	ASP	3.3
1	E	263	GLN	3.3
1	C	216	GLU	3.3
1	E	282	LEU	3.3
1	D	197	SER	3.3
1	E	138	GLY	3.3
1	B	276	GLN	3.3
1	D	198	LYS	3.3
1	A	104	THR	3.3
1	C	254	GLN	3.3
1	D	136	PHE	3.3
1	B	329	ILE	3.3
1	C	300	THR	3.3
1	A	209	ILE	3.3
1	A	189	GLY	3.3
1	F	266	PHE	3.3
1	E	254	GLN	3.3
1	B	284	ARG	3.3
1	A	213	ASP	3.2
1	A	198	LYS	3.2
1	E	276	GLN	3.2
1	B	138	GLY	3.2
1	B	286	TYR	3.2
1	F	93	ASN	3.2
1	E	237	GLN	3.2
1	C	188	PHE	3.2
1	C	152	LYS	3.2
1	E	110	PHE	3.2
1	A	150	GLN	3.2
1	B	159	GLU	3.2

Continued on next page...

Continued from previous page...

Mol	Chain	Res	Type	RSRZ
1	F	110	PHE	3.2
1	C	275	LEU	3.2
1	F	133	ASN	3.1
1	C	115	TYR	3.1
1	D	217	THR	3.1
1	B	244	VAL	3.1
1	E	184	ASN	3.1
1	C	201	TRP	3.1
1	D	224	TYR	3.1
1	D	244	VAL	3.1
1	C	250	ALA	3.1
1	D	188	PHE	3.1
1	F	187	GLY	3.1
1	E	104	THR	3.1
1	D	282	LEU	3.1
1	C	261	GLN	3.1
1	A	166	ARG	3.1
1	B	257	GLU	3.1
1	E	320	ASP	3.1
1	F	252	LYS	3.1
1	B	153	ASN	3.0
1	F	153	ASN	3.0
1	F	210	GLY	3.0
1	C	155	SER	3.0
1	F	32	ASP	3.0
1	F	132	ARG	3.0
1	B	277	SER	3.0
1	E	69	ASN	3.0
1	E	211	THR	3.0
1	D	189	GLY	3.0
1	E	283	GLY	3.0
1	F	115	TYR	3.0
1	B	252	LYS	3.0
1	F	223	LYS	3.0
1	C	223	LYS	3.0
1	E	244	VAL	3.0
1	B	103	TRP	3.0
1	F	300	THR	3.0
1	B	188	PHE	3.0
1	B	323	PHE	3.0
1	F	184	ASN	3.0
1	F	328	GLY	3.0

Continued on next page...

Continued from previous page...

Mol	Chain	Res	Type	RSRZ
1	F	322	ARG	2.9
1	C	268	LEU	2.9
1	D	196	SER	2.9
1	F	44	THR	2.9
1	E	240	ASN	2.9
1	D	162	THR	2.9
1	F	259	VAL	2.9
1	A	86	GLY	2.9
1	E	20	LEU	2.9
1	A	114	THR	2.9
1	A	242	THR	2.9
1	F	100	VAL	2.9
1	A	275	LEU	2.9
1	C	69	ASN	2.9
1	B	217	THR	2.9
1	D	210	GLY	2.9
1	C	329	ILE	2.9
1	D	114	THR	2.9
1	F	51	THR	2.9
1	F	145	PHE	2.9
1	D	137	PHE	2.8
1	C	128	PHE	2.8
1	A	254	GLN	2.8
1	C	150	GLN	2.8
1	A	139	LEU	2.8
1	E	49	GLN	2.8
1	C	299	ALA	2.8
1	A	46	VAL	2.8
1	D	320	ASP	2.8
1	E	229	ILE	2.8
1	F	232	ALA	2.8
1	B	290	ASP	2.8
1	A	250	ALA	2.8
1	C	311	VAL	2.8
1	C	230	TYR	2.7
1	E	234	GLN	2.7
1	D	274	TYR	2.7
1	F	127	GLY	2.7
1	D	169	VAL	2.7
1	F	150	GLN	2.7
1	D	289	GLU	2.7
1	C	63	ASN	2.7

Continued on next page...

Continued from previous page...

Mol	Chain	Res	Type	RSRZ
1	C	281	ASN	2.7
1	A	257	GLU	2.7
1	B	262	TYR	2.7
1	D	190	ILE	2.7
1	D	273	ALA	2.7
1	F	294	TYR	2.7
1	A	82	PHE	2.7
1	A	201	TRP	2.7
1	C	76	ALA	2.7
1	A	51	THR	2.7
1	E	101	THR	2.7
1	D	151	GLY	2.7
1	C	257	GLU	2.7
1	F	215	ALA	2.7
1	D	163	THR	2.6
1	A	97	VAL	2.6
1	E	215	ALA	2.6
1	F	137	PHE	2.6
1	A	244	VAL	2.6
1	B	223	LYS	2.6
1	F	264	PHE	2.6
1	C	31	GLY	2.6
1	C	264	PHE	2.6
1	F	76	ALA	2.6
1	A	223	LYS	2.6
1	F	257	GLU	2.6
1	E	265	ASP	2.6
1	D	223	LYS	2.6
1	F	248	GLY	2.6
1	F	109	GLU	2.6
1	C	20	LEU	2.6
1	E	261	GLN	2.6
1	E	235	TYR	2.6
1	F	88	PHE	2.6
1	F	310	TYR	2.6
1	D	200	THR	2.6
1	B	183	TYR	2.6
1	E	286	TYR	2.6
1	C	32	ASP	2.6
1	C	284	ARG	2.6
1	A	231	LEU	2.6
1	C	107	LEU	2.6

Continued on next page...

Continued from previous page...

Mol	Chain	Res	Type	RSRZ
1	D	69	ASN	2.6
1	F	200	THR	2.6
1	E	284	ARG	2.5
1	A	288	ASP	2.5
1	B	152	LYS	2.5
1	C	295	VAL	2.5
1	E	115	TYR	2.5
1	F	203	GLN	2.5
1	C	93	ASN	2.5
1	E	268	LEU	2.5
1	E	137	PHE	2.5
1	D	142	GLY	2.5
1	E	336	ALA	2.5
1	A	264	PHE	2.5
1	D	121	MET	2.5
1	B	143	LEU	2.5
1	A	217	THR	2.5
1	D	284	ARG	2.5
1	B	211	THR	2.5
1	B	151	GLY	2.5
1	E	195	SER	2.5
1	C	130	THR	2.5
1	D	235	TYR	2.5
1	F	239	TYR	2.5
1	D	166	ARG	2.5
1	E	312	ASP	2.5
1	A	331	THR	2.4
1	A	255	ASN	2.4
1	D	172	GLN	2.4
1	C	231	LEU	2.4
1	A	120	PHE	2.4
1	A	230	TYR	2.4
1	C	241	ALA	2.4
1	B	164	ASN	2.4
1	C	324	THR	2.4
1	C	331	THR	2.4
1	C	310	TYR	2.4
1	F	326	ASP	2.4
1	D	216	GLU	2.4
1	C	161	MET	2.4
1	D	174	GLY	2.4
1	F	116	ASP	2.4

Continued on next page...

Continued from previous page...

Mol	Chain	Res	Type	RSRZ
1	B	336	ALA	2.4
1	C	301	TYR	2.4
1	E	144	ASP	2.4
1	F	128	PHE	2.4
1	C	218	TYR	2.4
1	F	309	THR	2.4
1	C	314	LYS	2.4
1	A	136	PHE	2.4
1	B	150	GLN	2.4
1	B	224	TYR	2.4
1	B	313	TYR	2.4
1	E	230	TYR	2.4
1	A	317	LEU	2.4
1	C	267	GLY	2.4
1	F	327	ALA	2.4
1	B	107	LEU	2.4
1	D	85	VAL	2.3
1	F	230	TYR	2.3
1	E	139	LEU	2.3
1	B	238	THR	2.3
1	F	202	ASP	2.3
1	D	257	GLU	2.3
1	D	152	LYS	2.3
1	E	97	VAL	2.3
1	A	107	LEU	2.3
1	C	239	TYR	2.3
1	E	266	PHE	2.3
1	F	69	ASN	2.3
1	C	279	GLY	2.3
1	A	153	ASN	2.3
1	A	173	ASN	2.3
1	D	107	LEU	2.3
1	B	149	TYR	2.3
1	D	50	LEU	2.3
1	A	115	TYR	2.3
1	C	335	VAL	2.3
1	E	323	PHE	2.3
1	A	266	PHE	2.3
1	A	69	ASN	2.3
1	C	202	ASP	2.3
1	B	268	LEU	2.3
1	A	234	GLN	2.3

Continued on next page...

Continued from previous page...

Mol	Chain	Res	Type	RSRZ
1	C	145	PHE	2.3
1	B	133	ASN	2.3
1	B	230	TYR	2.3
1	D	317	LEU	2.2
1	C	270	PRO	2.2
1	A	294	TYR	2.2
1	C	109	GLU	2.2
1	A	116	ASP	2.2
1	F	206	THR	2.2
1	B	166	ARG	2.2
1	A	262	TYR	2.2
1	F	231	LEU	2.2
1	A	165	GLY	2.2
1	C	44	THR	2.2
1	B	218	TYR	2.2
1	A	101	THR	2.2
1	F	208	LEU	2.2
1	D	259	VAL	2.2
1	D	250	ALA	2.2
1	F	218	TYR	2.2
1	C	124	HIS	2.2
1	D	127	GLY	2.2
1	E	111	GLY	2.2
1	D	262	TYR	2.2
1	E	318	LEU	2.2
1	B	249	TRP	2.2
1	E	335	VAL	2.2
1	E	210	GLY	2.2
1	E	328	GLY	2.2
1	C	33	LYS	2.2
1	E	327	ALA	2.2
1	C	120	PHE	2.2
1	B	283	GLY	2.2
1	E	152	LYS	2.2
1	F	214	ARG	2.2
1	E	142	GLY	2.1
1	E	248	GLY	2.1
1	F	112	GLY	2.1
1	C	148	GLN	2.1
1	E	150	GLN	2.1
1	F	270	PRO	2.1
1	F	267	GLY	2.1

Continued on next page...

Continued from previous page...

Mol	Chain	Res	Type	RSRZ
1	A	282	LEU	2.1
1	F	138	GLY	2.1
1	A	241	ALA	2.1
1	E	334	ILE	2.1
1	A	206	THR	2.1
1	C	169	VAL	2.1
1	D	231	LEU	2.1
1	B	264	PHE	2.1
1	C	276	GLN	2.1
1	F	152	LYS	2.1
1	C	22	TYR	2.1
1	D	115	TYR	2.1
1	F	288	ASP	2.1
1	E	259	VAL	2.1
1	B	154	GLY	2.1
1	D	143	LEU	2.1
1	F	173	ASN	2.1
1	C	195	SER	2.1
1	B	254	GLN	2.1
1	F	107	LEU	2.1
1	F	158	GLY	2.1
1	D	264	PHE	2.1
1	B	259	VAL	2.1
1	E	71	SER	2.1
1	F	22	TYR	2.1
1	C	153	ASN	2.1
1	F	274	TYR	2.1
1	F	190	ILE	2.1
1	D	40	PHE	2.0
1	D	236	THR	2.0
1	C	50	LEU	2.0
1	A	196	SER	2.0
1	E	257	GLU	2.0
1	F	244	VAL	2.0
1	B	120	PHE	2.0
1	D	225	ASP	2.0
1	E	287	ASP	2.0
1	B	209	ILE	2.0
1	B	104	THR	2.0
1	B	200	THR	2.0
1	B	203	GLN	2.0
1	C	100	VAL	2.0

Continued on next page...

Continued from previous page...

Mol	Chain	Res	Type	RSRZ
1	D	113	ASP	2.0
1	A	199	ARG	2.0
1	B	190	ILE	2.0
1	B	258	ALA	2.0
1	D	334	ILE	2.0
1	B	174	GLY	2.0
1	C	309	THR	2.0
1	A	45	GLN	2.0
1	D	288	ASP	2.0
1	D	319	ASP	2.0
1	E	325	ARG	2.0
1	A	236	THR	2.0
1	E	153	ASN	2.0
1	F	164	ASN	2.0
1	A	292	LEU	2.0
1	E	243	ARG	2.0

6.2 Non-standard residues in protein, DNA, RNA chains [i](#)

There are no non-standard protein/DNA/RNA residues in this entry.

6.3 Carbohydrates [i](#)

There are no monosaccharides in this entry.

6.4 Ligands [i](#)

In the following table, the Atoms column lists the number of modelled atoms in the group and the number defined in the chemical component dictionary. The B-factors column lists the minimum, median, 95th percentile and maximum values of B factors of atoms in the group. The column labelled 'Q< 0.9' lists the number of atoms with occupancy less than 0.9.

Mol	Type	Chain	Res	Atoms	RSCC	RSR	B-factors(Å ²)	Q<0.9
2	SO4	C	1344	5/5	0.69	0.43	190,214,217,225	0
2	SO4	D	1344	5/5	0.76	0.46	148,169,201,210	0
2	SO4	A	1344	5/5	0.82	0.52	170,179,185,186	0

6.5 Other polymers [i](#)

There are no such residues in this entry.