



Full wwPDB EM Validation Report ⓘ

Oct 22, 2024 – 12:28 AM JST

PDB ID : 8XQB
EMDB ID : EMD-38572
Title : Mature virion portal vertex of bacteriophage lambda
Authors : Wang, J.W.; Gu, Z.W.
Deposited on : 2024-01-05
Resolution : 4.07 Å (reported)

This is a Full wwPDB EM Validation Report for a publicly released PDB entry.

We welcome your comments at validation@mail.wwpdb.org

A user guide is available at

<https://www.wwpdb.org/validation/2017/EMValidationReportHelp>

with specific help available everywhere you see the ⓘ symbol.

The types of validation reports are described at

<http://www.wwpdb.org/validation/2017/FAQs#types>.

The following versions of software and data (see [references ⓘ](#)) were used in the production of this report:

EMDB validation analysis : 0.0.1.dev113
MolProbity : 4.02b-467
Percentile statistics : 20231227.v01 (using entries in the PDB archive December 27th 2023)
MapQ : 1.9.13
Ideal geometry (proteins) : Engh & Huber (2001)
Ideal geometry (DNA, RNA) : Parkinson et al. (1996)
Validation Pipeline (wwPDB-VP) : 2.39

1 Overall quality at a glance

The following experimental techniques were used to determine the structure:
ELECTRON MICROSCOPY

The reported resolution of this entry is 4.07 Å.

Percentile scores (ranging between 0-100) for global validation metrics of the entry are shown in the following graphic. The table shows the number of entries on which the scores are based.

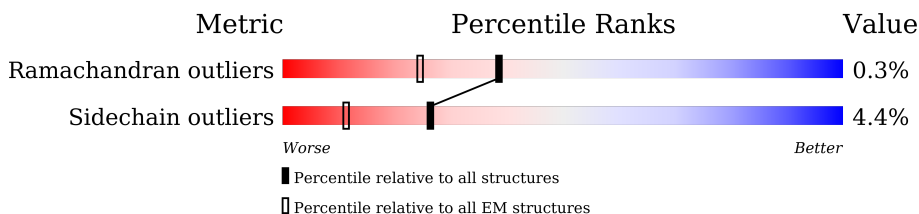

Metric	Whole archive (#Entries)	EM structures (#Entries)
Ramachandran outliers	207382	16835
Sidechain outliers	206894	16415

The table below summarises the geometric issues observed across the polymeric chains and their fit to the map. The red, orange, yellow and green segments of the bar indicate the fraction of residues that contain outliers for ≥ 3 , 2, 1 and 0 types of geometric quality criteria respectively. A grey segment represents the fraction of residues that are not modelled. The numeric value for each fraction is indicated below the corresponding segment, with a dot representing fractions $\leq 5\%$. The upper red bar (where present) indicates the fraction of residues that have poor fit to the EM map (all-atom inclusion $< 40\%$). The numeric value is given above the bar.

Mol	Chain	Length	Quality of chain
1	f	117	
1	f1	117	
1	f2	117	
1	f3	117	
1	f4	117	
1	f5	117	
2	W	68	
2	W1	68	
2	W2	68	

Continued on next page...

Continued from previous page...

Mol	Chain	Length	Quality of chain
2	W3	68	9% 93% 6%
2	W4	68	19% 88% 10%
2	W5	68	13% 97% ..
2	w	68	13% 94% ..
2	w1	68	16% 94% ..
2	w2	68	13% 94% ..
2	w3	68	10% 96% ..
2	w4	68	9% 94% ..
2	w5	68	10% 91% 7%
3	U	131	10% 95% 5%
3	U1	131	11% 95% 5%
3	U2	131	7% 95% 5%
3	U3	131	14% 92% 8%
3	U4	131	12% 95% 5%
3	U5	131	18% 96% .
4	B	533	20% 86% 11%
4	B1	533	19% 86% 11%
4	B2	533	19% 86% 11%
4	B3	533	20% 87% 11%
4	B4	533	20% 87% 11%
4	B5	533	20% 87% 11%
4	b	533	16% 86% 11%
4	b1	533	21% 86% 11%
4	b2	533	20% 87% 11%
4	b3	533	26% 86% 11%

Continued on next page...

Continued from previous page...

Mol	Chain	Length	Quality of chain
4	b4	533	20% 86% 11%
4	b5	533	17% 86% 11%
5	A0	341	29% 95% 5%
5	A1	341	28% 94% 5%
5	A2	341	26% 92% 7%
5	A3	341	28% 94% 6%
5	A4	341	31% 95% 5%
5	C0	341	20% 96% ..
5	C1	341	18% 94% 6%
5	C2	341	20% 94% 6%
5	C3	341	18% 94% 6%
5	C4	341	18% 92% 7%
5	G0	341	17% 93% 6%
5	G1	341	13% 94% 5%
5	G2	341	18% 94% 5%
5	G3	341	16% 92% 7%
5	G4	341	17% 92% 7%
6	H0	110	5% 98% ..
6	H1	110	5% 97% ..
6	H2	110	. 97% ..
6	H3	110	5% 97% ..
6	H4	110	5% 95% 5%
6	I0	110	16% 95% 5%
6	I1	110	18% 97% ..
6	I2	110	15% 96% ..

Continued on next page...

Continued from previous page...

Mol	Chain	Length	Quality of chain
6	I3	110	16% 97%
6	I4	110	16% 96%
6	J0	110	6% 97%
6	J1	110	5% 95%
6	J2	110	6% 95%
6	J3	110	6% 95%
6	J4	110	6% 96%
6	N0	110	41% 95%
6	N1	110	37% 96%
6	N2	110	41% 98%
6	N3	110	46% 97%
6	N4	110	48% 96%

2 Entry composition [i](#)

There are 6 unique types of molecules in this entry. The entry contains 118514 atoms, of which 0 are hydrogens and 0 are deuteriums.

In the tables below, the AltConf column contains the number of residues with at least one atom in alternate conformation and the Trace column contains the number of residues modelled with at most 2 atoms.

- Molecule 1 is a protein called Head-tail connector protein FII.

Mol	Chain	Residues	Atoms					AltConf	Trace
1	f	114	Total	C	N	O	S	0	0
			872	535	161	174	2		
1	f1	114	Total	C	N	O	S	0	0
			872	535	161	174	2		
1	f2	114	Total	C	N	O	S	0	0
			872	535	161	174	2		
1	f3	114	Total	C	N	O	S	0	0
			872	535	161	174	2		
1	f4	114	Total	C	N	O	S	0	0
			872	535	161	174	2		
1	f5	114	Total	C	N	O	S	0	0
			872	535	161	174	2		

- Molecule 2 is a protein called Head completion protein.

Mol	Chain	Residues	Atoms					AltConf	Trace
2	W	67	Total	C	N	O	S	0	0
			524	323	101	98	2		
2	w	67	Total	C	N	O	S	0	0
			524	323	101	98	2		
2	W1	67	Total	C	N	O	S	0	0
			524	323	101	98	2		
2	w1	67	Total	C	N	O	S	0	0
			524	323	101	98	2		
2	W2	67	Total	C	N	O	S	0	0
			524	323	101	98	2		
2	w2	67	Total	C	N	O	S	0	0
			524	323	101	98	2		
2	W3	67	Total	C	N	O	S	0	0
			524	323	101	98	2		
2	w3	67	Total	C	N	O	S	0	0
			524	323	101	98	2		
2	W4	67	Total	C	N	O	S	0	0
			524	323	101	98	2		

Continued on next page...

Continued from previous page...

Mol	Chain	Residues	Atoms					AltConf	Trace
2	w4	67	Total	C	N	O	S	0	0
			524	323	101	98	2		
2	W5	67	Total	C	N	O	S	0	0
			524	323	101	98	2		
2	w5	67	Total	C	N	O	S	0	0
			524	323	101	98	2		

- Molecule 3 is a protein called Tail tube terminator protein.

Mol	Chain	Residues	Atoms					AltConf	Trace
3	U	131	Total	C	N	O	S	0	0
			1032	655	159	213	5		
3	U1	131	Total	C	N	O	S	0	0
			1032	655	159	213	5		
3	U2	131	Total	C	N	O	S	0	0
			1032	655	159	213	5		
3	U3	131	Total	C	N	O	S	0	0
			1032	655	159	213	5		
3	U4	131	Total	C	N	O	S	0	0
			1032	655	159	213	5		
3	U5	131	Total	C	N	O	S	0	0
			1032	655	159	213	5		

- Molecule 4 is a protein called Portal protein B.

Mol	Chain	Residues	Atoms					AltConf	Trace
4	B	475	Total	C	N	O	S	0	0
			3727	2328	671	704	24		
4	b	473	Total	C	N	O	S	0	0
			3710	2316	669	701	24		
4	B1	475	Total	C	N	O	S	0	0
			3727	2328	671	704	24		
4	b1	473	Total	C	N	O	S	0	0
			3710	2316	669	701	24		
4	B2	475	Total	C	N	O	S	0	0
			3727	2328	671	704	24		
4	b2	473	Total	C	N	O	S	0	0
			3710	2316	669	701	24		
4	B3	475	Total	C	N	O	S	0	0
			3727	2328	671	704	24		
4	b3	473	Total	C	N	O	S	0	0
			3710	2316	669	701	24		

Continued on next page...

Continued from previous page...

Mol	Chain	Residues	Atoms					AltConf	Trace
4	B4	475	Total	C	N	O	S	0	0
			3727	2328	671	704	24		
4	b4	473	Total	C	N	O	S	0	0
			3710	2316	669	701	24		
4	B5	475	Total	C	N	O	S	0	0
			3727	2328	671	704	24		
4	b5	473	Total	C	N	O	S	0	0
			3710	2316	669	701	24		

- Molecule 5 is a protein called Major capsid protein.

Mol	Chain	Residues	Atoms					AltConf	Trace
5	A0	339	Total	C	N	O	S	0	0
			2669	1682	457	517	13		
5	G0	339	Total	C	N	O	S	0	0
			2669	1682	457	517	13		
5	C0	339	Total	C	N	O	S	0	0
			2669	1682	457	517	13		
5	A1	339	Total	C	N	O	S	0	0
			2669	1682	457	517	13		
5	G1	339	Total	C	N	O	S	0	0
			2669	1682	457	517	13		
5	C1	339	Total	C	N	O	S	0	0
			2669	1682	457	517	13		
5	A2	339	Total	C	N	O	S	0	0
			2669	1682	457	517	13		
5	G2	339	Total	C	N	O	S	0	0
			2669	1682	457	517	13		
5	C2	339	Total	C	N	O	S	0	0
			2669	1682	457	517	13		
5	A3	339	Total	C	N	O	S	0	0
			2669	1682	457	517	13		
5	G3	339	Total	C	N	O	S	0	0
			2669	1682	457	517	13		
5	C3	339	Total	C	N	O	S	0	0
			2669	1682	457	517	13		
5	A4	339	Total	C	N	O	S	0	0
			2669	1682	457	517	13		
5	G4	339	Total	C	N	O	S	0	0
			2669	1682	457	517	13		
5	C4	339	Total	C	N	O	S	0	0
			2669	1682	457	517	13		

- Molecule 6 is a protein called Capsid decoration protein.

Mol	Chain	Residues	Atoms					AltConf	Trace
6	H0	109	Total	C	N	O	S	1	0
			809	508	134	165	2		
6	I0	109	Total	C	N	O	S	1	0
			809	508	134	165	2		
6	J0	108	Total	C	N	O	S	1	0
			802	504	133	163	2		
6	N0	109	Total	C	N	O	S	1	0
			809	508	134	165	2		
6	H1	109	Total	C	N	O	S	1	0
			809	508	134	165	2		
6	I1	109	Total	C	N	O	S	1	0
			809	508	134	165	2		
6	J1	108	Total	C	N	O	S	1	0
			802	504	133	163	2		
6	N1	109	Total	C	N	O	S	1	0
			809	508	134	165	2		
6	H2	109	Total	C	N	O	S	1	0
			809	508	134	165	2		
6	I2	109	Total	C	N	O	S	1	0
			809	508	134	165	2		
6	J2	108	Total	C	N	O	S	1	0
			802	504	133	163	2		
6	N2	109	Total	C	N	O	S	1	0
			809	508	134	165	2		
6	H3	109	Total	C	N	O	S	1	0
			809	508	134	165	2		
6	I3	109	Total	C	N	O	S	1	0
			809	508	134	165	2		
6	J3	108	Total	C	N	O	S	1	0
			802	504	133	163	2		
6	N3	109	Total	C	N	O	S	1	0
			809	508	134	165	2		
6	H4	109	Total	C	N	O	S	1	0
			809	508	134	165	2		
6	I4	109	Total	C	N	O	S	1	0
			809	508	134	165	2		
6	J4	108	Total	C	N	O	S	1	0
			802	504	133	163	2		
6	N4	109	Total	C	N	O	S	1	0
			809	508	134	165	2		

3 Residue-property plots [i](#)

These plots are drawn for all protein, RNA, DNA and oligosaccharide chains in the entry. The first graphic for a chain summarises the proportions of the various outlier classes displayed in the second graphic. The second graphic shows the sequence view annotated by issues in geometry and atom inclusion in map density. Residues are color-coded according to the number of geometric quality criteria for which they contain at least one outlier: green = 0, yellow = 1, orange = 2 and red = 3 or more. A red diamond above a residue indicates a poor fit to the EM map for this residue (all-atom inclusion < 40%). Stretches of 2 or more consecutive residues without any outlier are shown as a green connector. Residues present in the sample, but not in the model, are shown in grey.

- Molecule 1: Head-tail connector protein FII

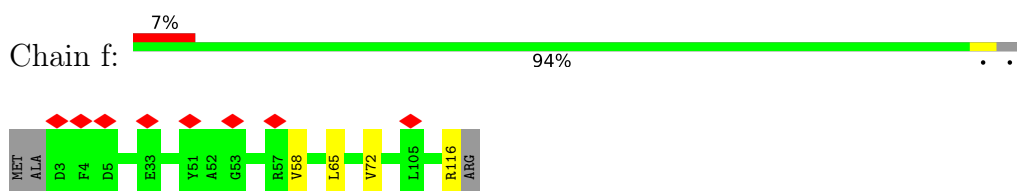

- Molecule 1: Head-tail connector protein FII

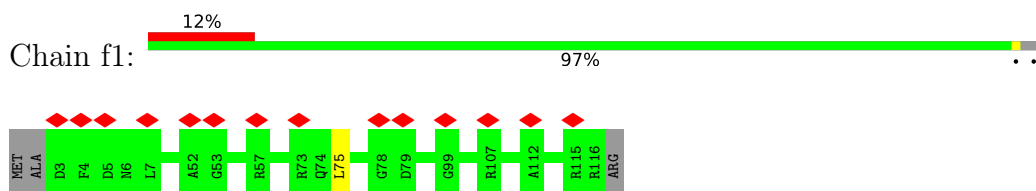

- Molecule 1: Head-tail connector protein FII

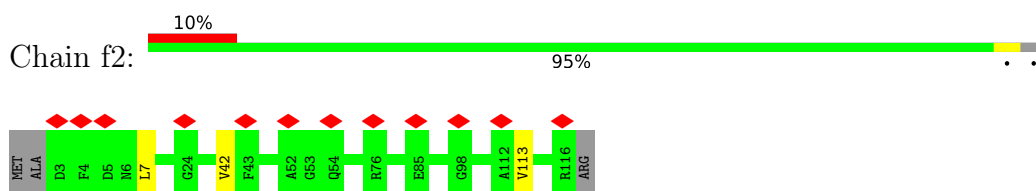

- Molecule 1: Head-tail connector protein FII

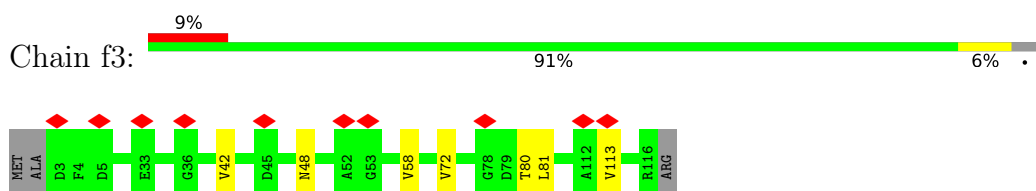

- Molecule 1: Head-tail connector protein FII

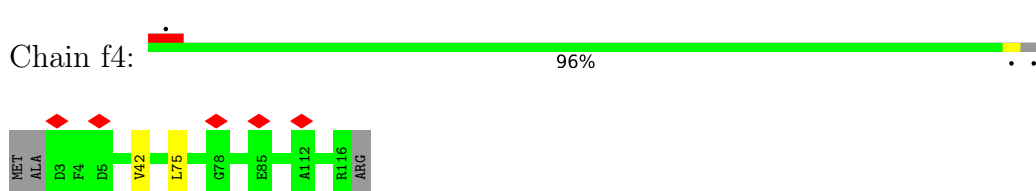

- Molecule 1: Head-tail connector protein FII

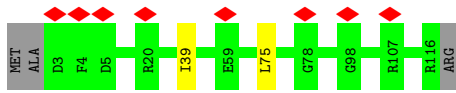

- Molecule 2: Head completion protein

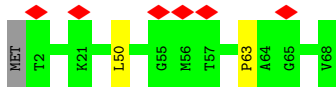

- Molecule 2: Head completion protein

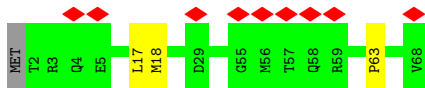

- Molecule 2: Head completion protein

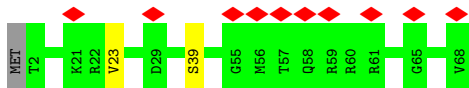

- Molecule 2: Head completion protein

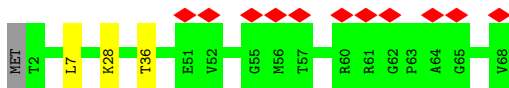

- Molecule 2: Head completion protein

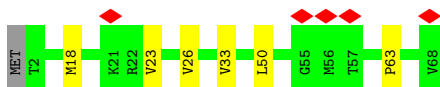

- Molecule 2: Head completion protein



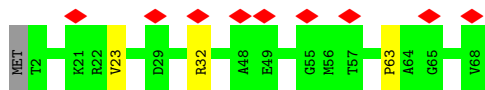

- Molecule 2: Head completion protein

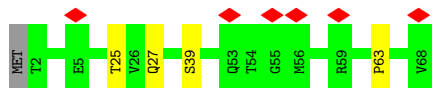

- Molecule 2: Head completion protein

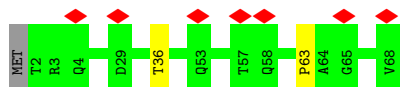

- Molecule 2: Head completion protein

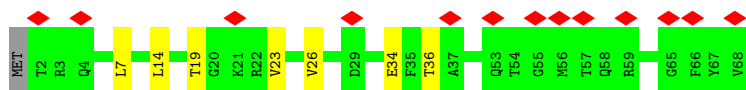
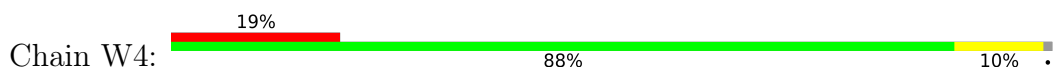

- Molecule 2: Head completion protein

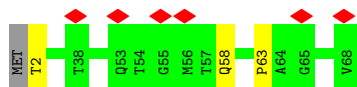

- Molecule 2: Head completion protein

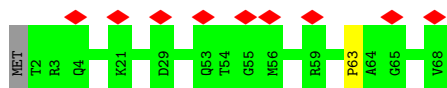

- Molecule 2: Head completion protein

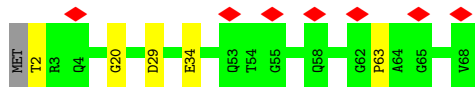
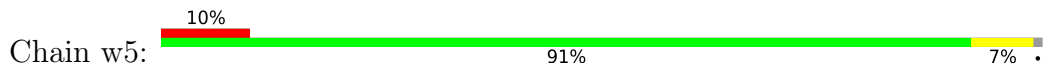

- Molecule 3: Tail tube terminator protein

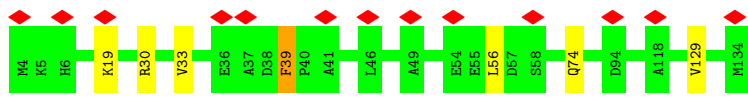

• Molecule 3: Tail tube terminator protein

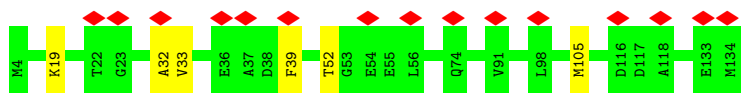

• Molecule 3: Tail tube terminator protein

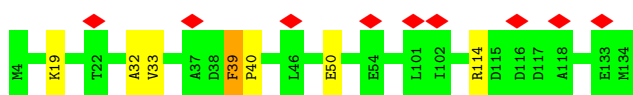

• Molecule 3: Tail tube terminator protein

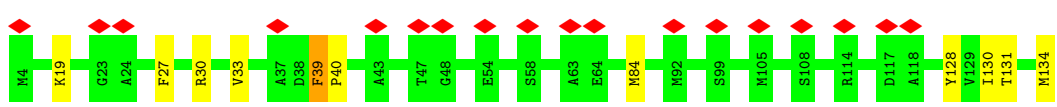
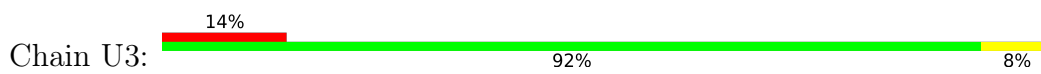

• Molecule 3: Tail tube terminator protein

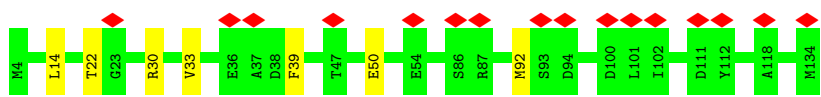

• Molecule 3: Tail tube terminator protein

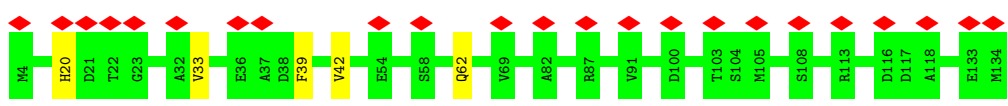

• Molecule 4: Portal protein B

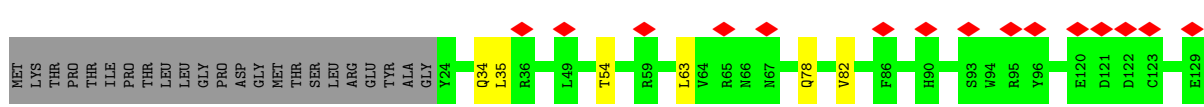
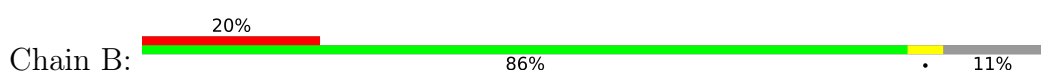

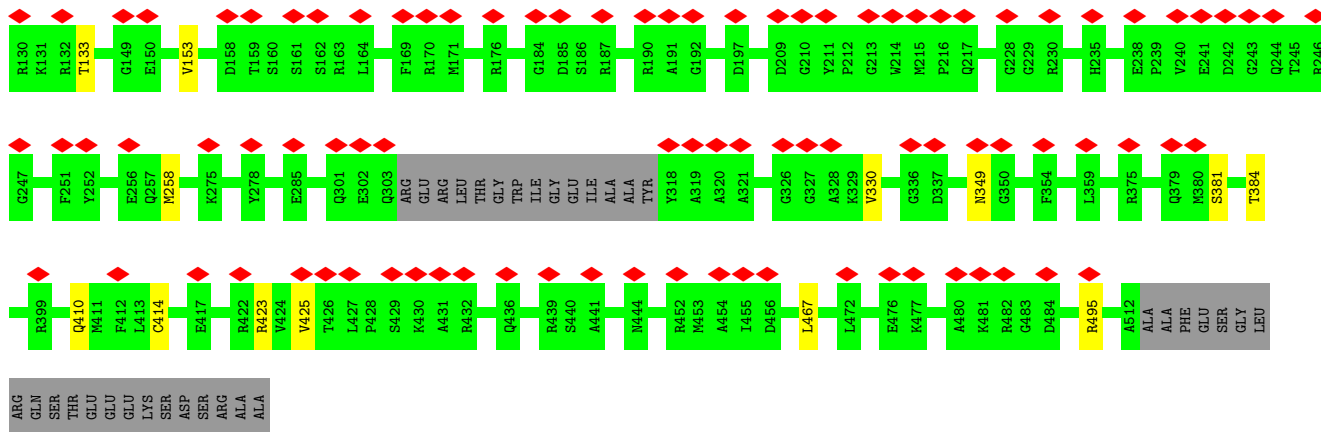

• Molecule 4: Portal protein B

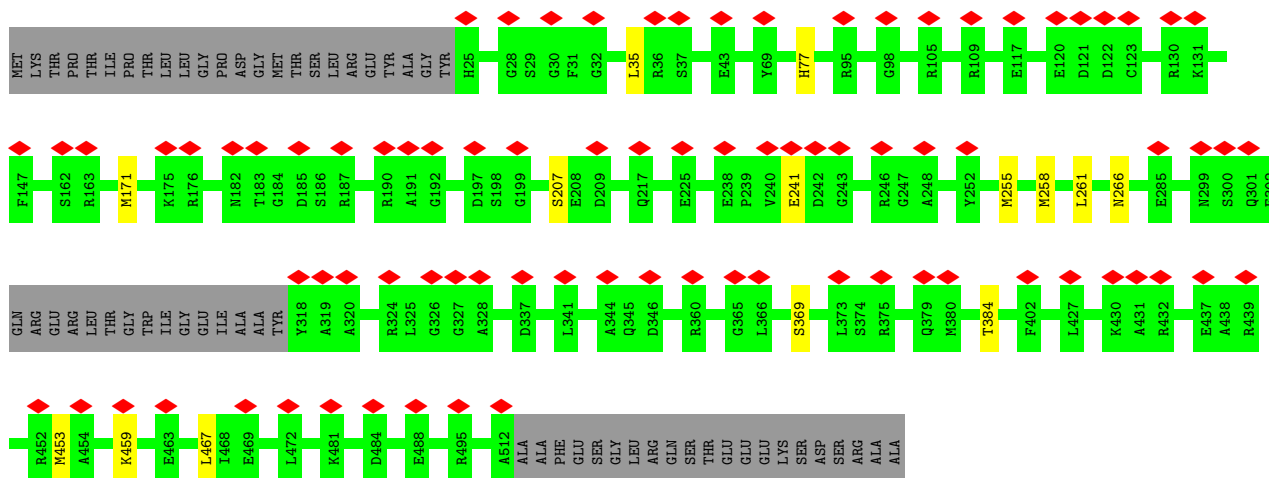
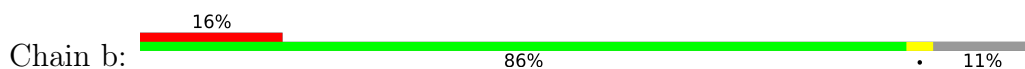

• Molecule 4: Portal protein B

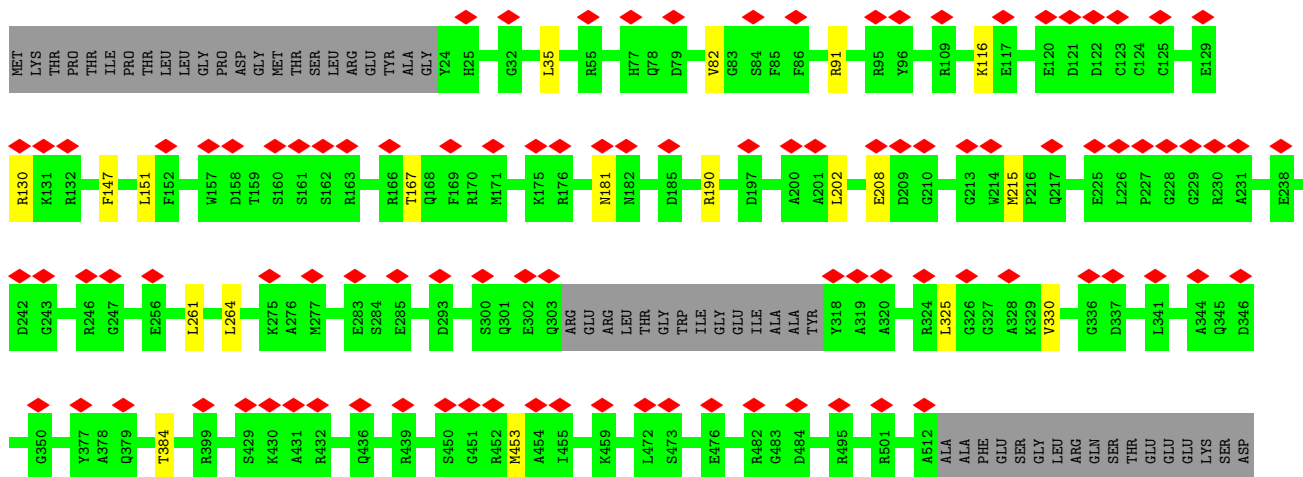
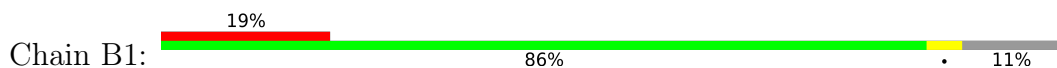

SER
ARG
ALA
ALA

• Molecule 4: Portal protein B

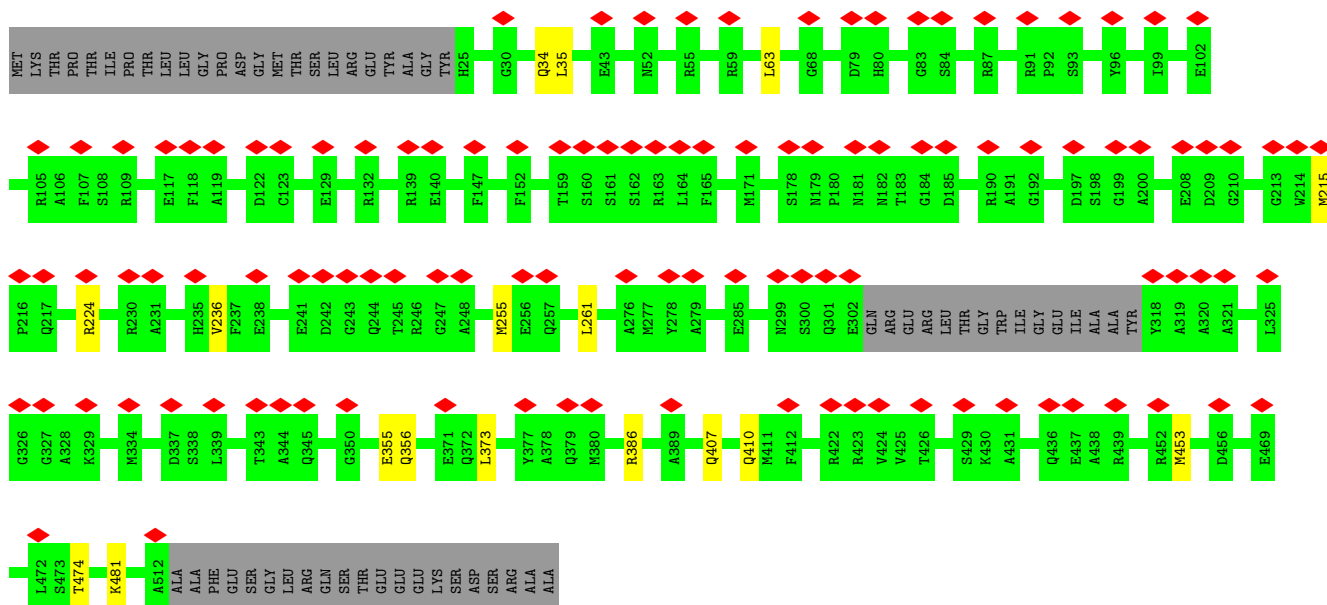
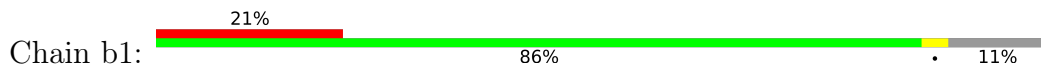

• Molecule 4: Portal protein B

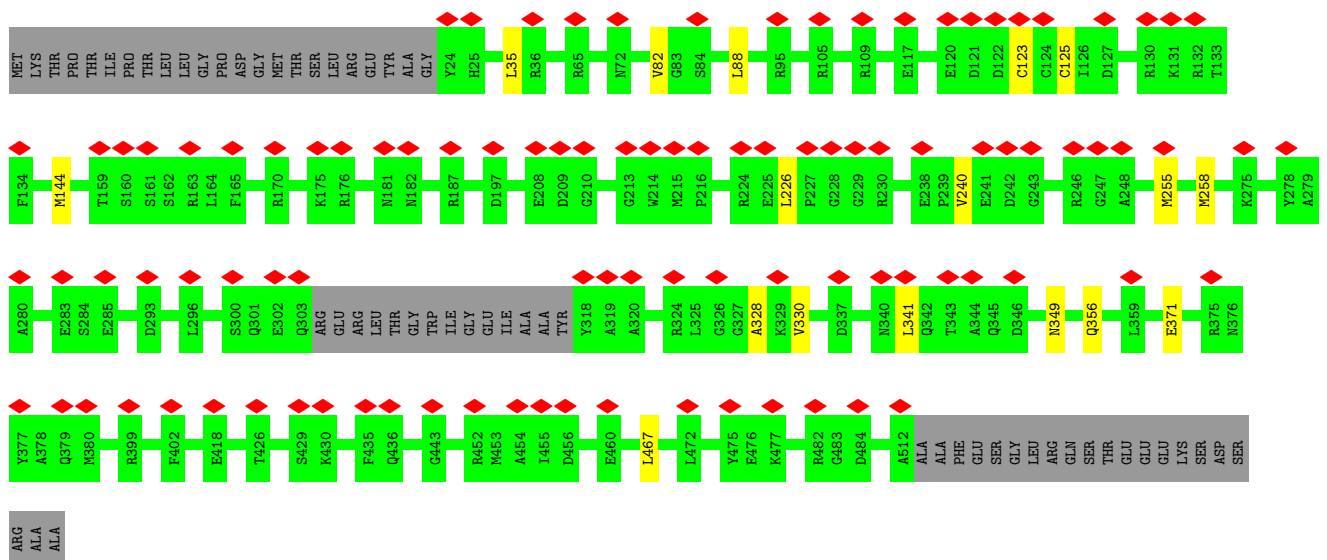
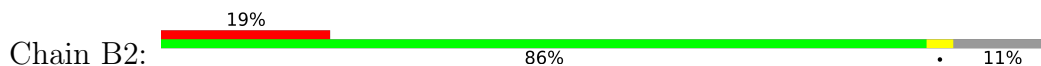

• Molecule 4: Portal protein B

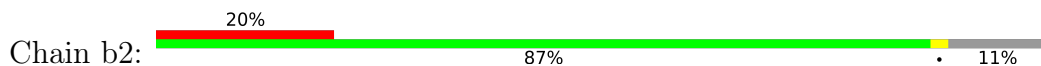

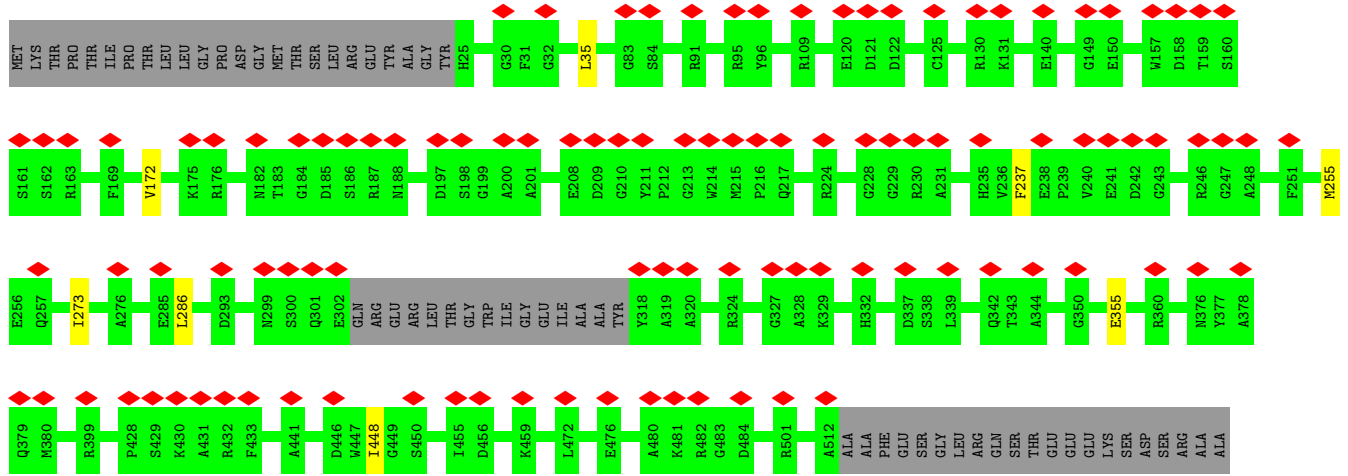

• Molecule 4: Portal protein B

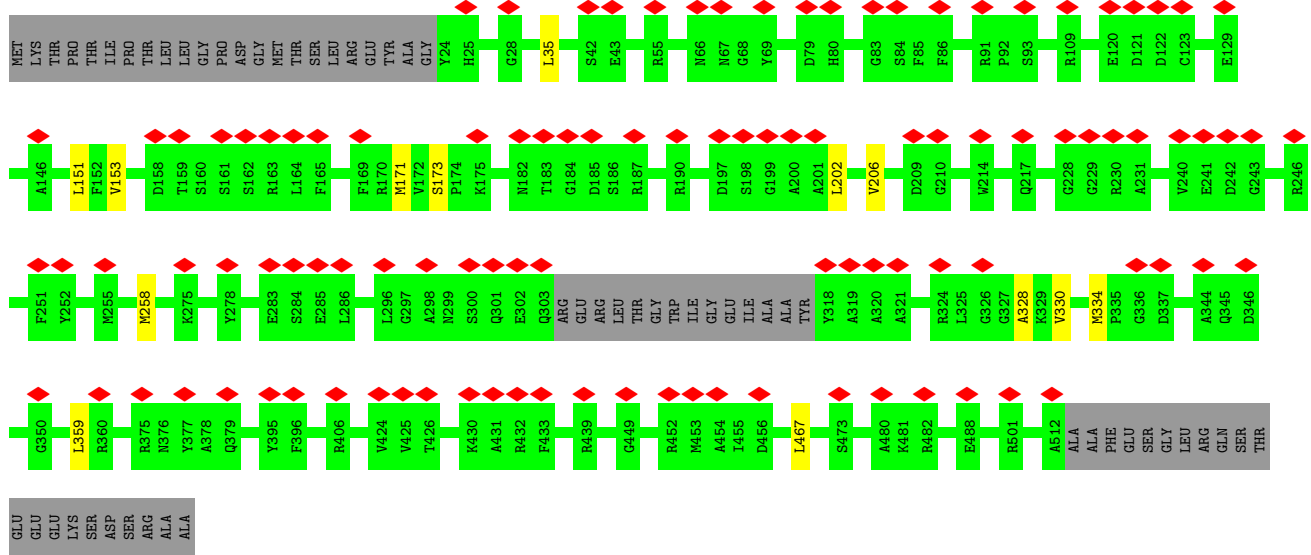
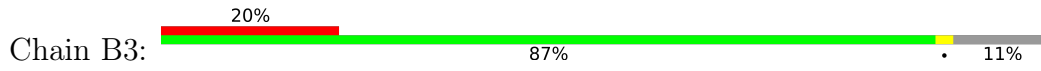

• Molecule 4: Portal protein B

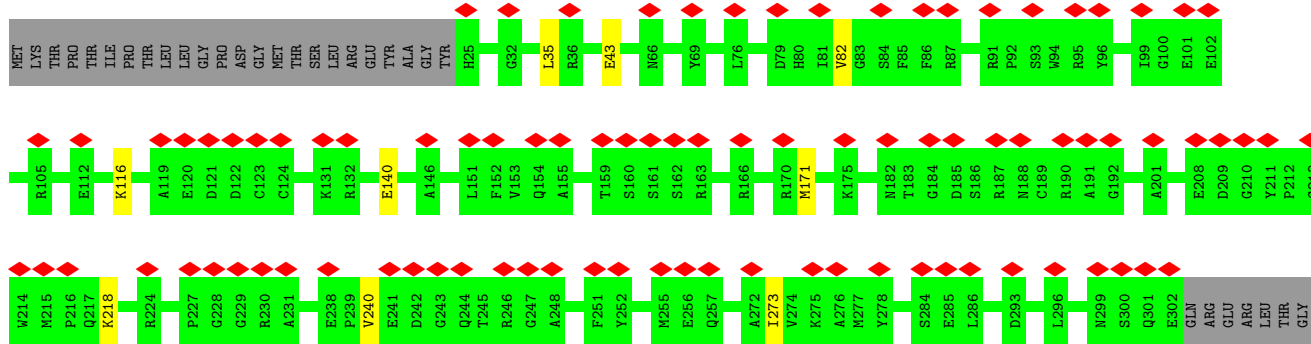
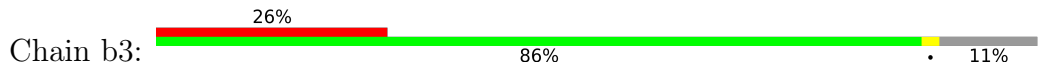

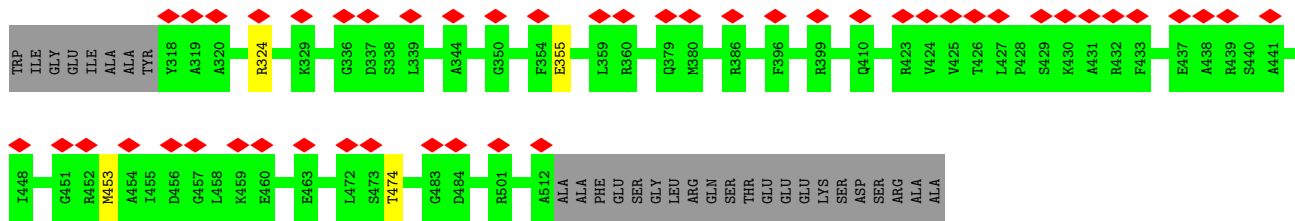

• Molecule 4: Portal protein B

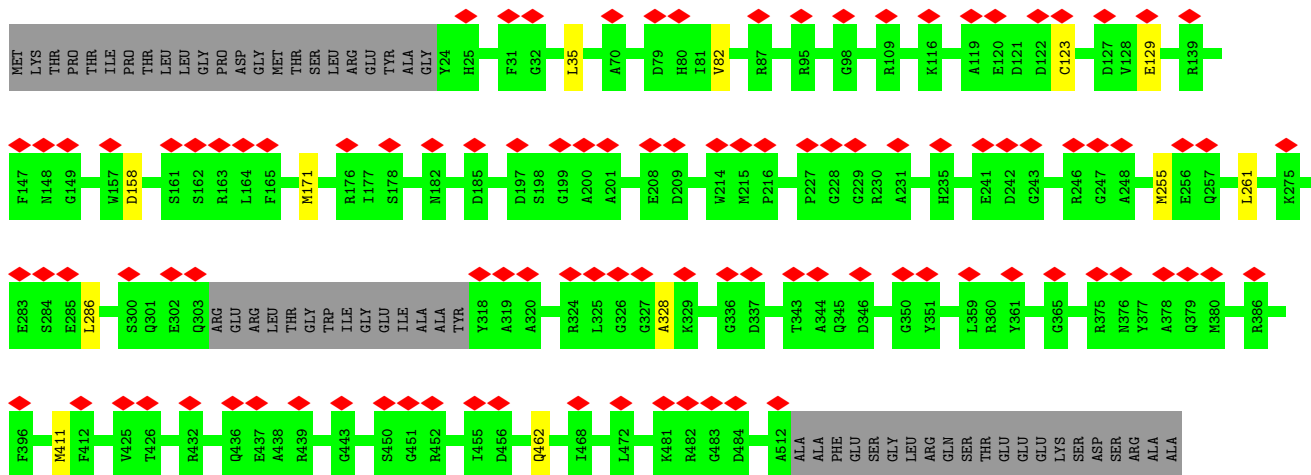
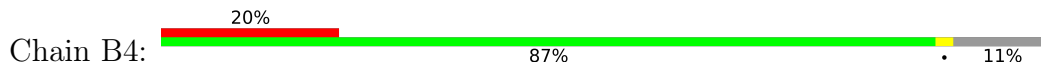

• Molecule 4: Portal protein B

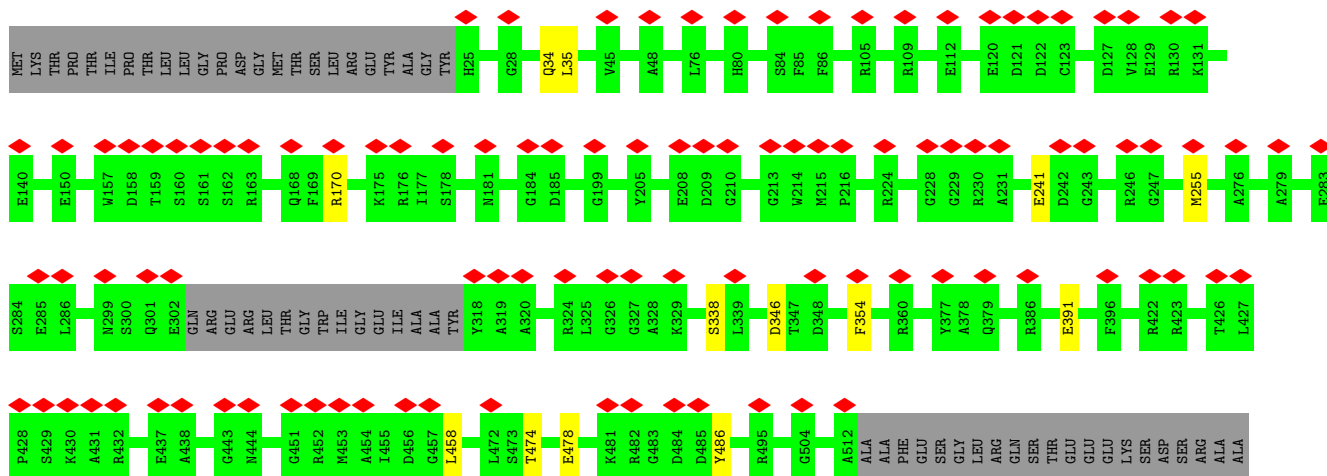
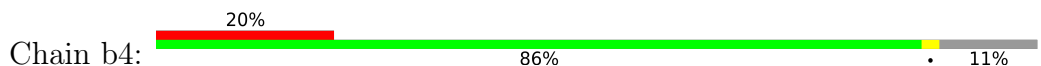

• Molecule 4: Portal protein B

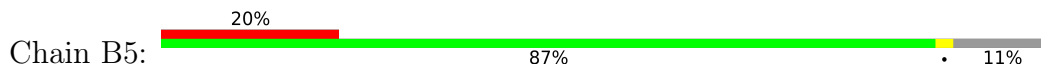

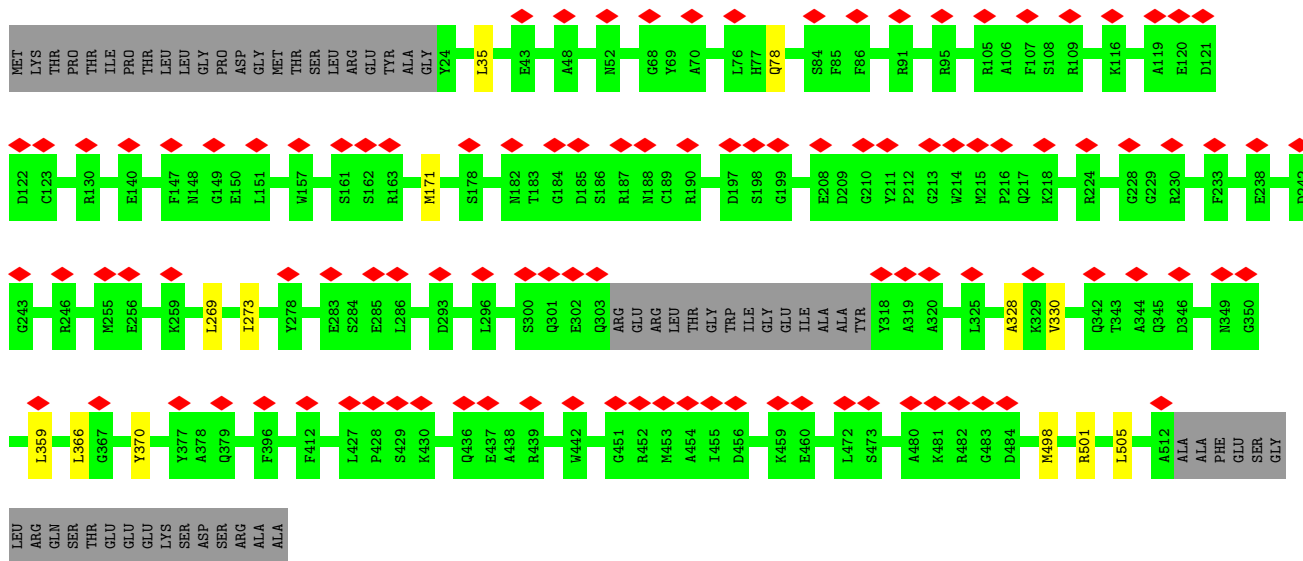

• Molecule 4: Portal protein B

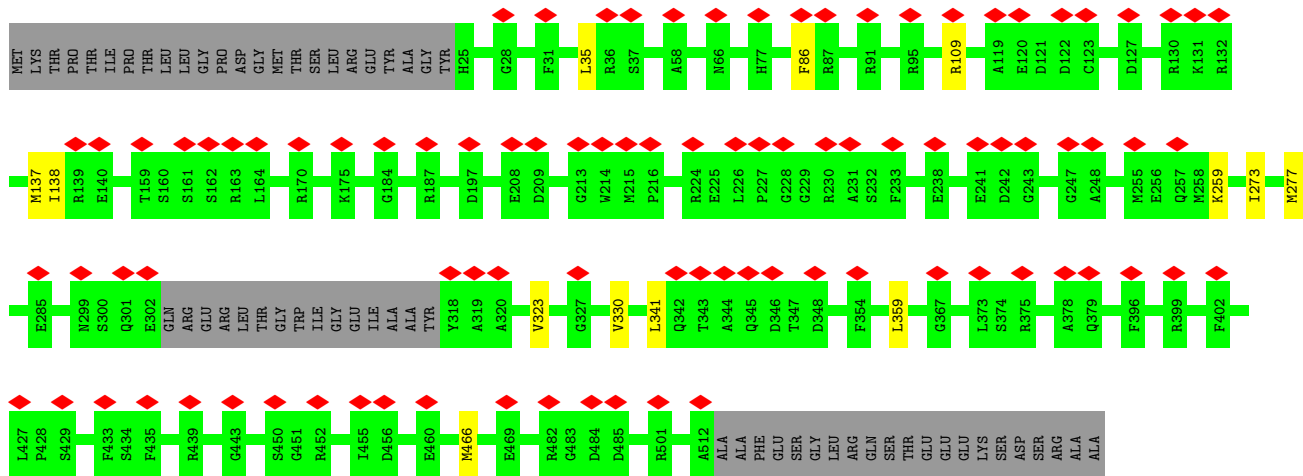
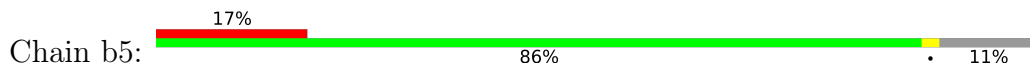

• Molecule 5: Major capsid protein

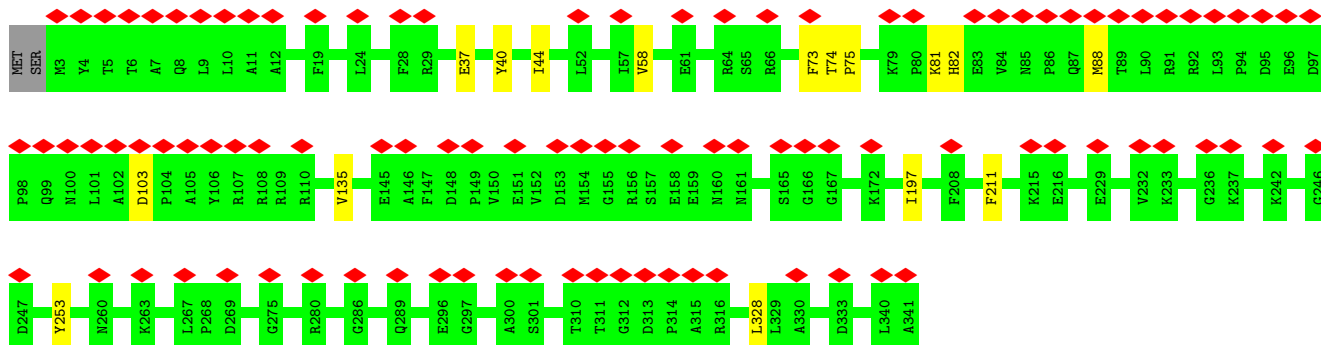

• Molecule 5: Major capsid protein

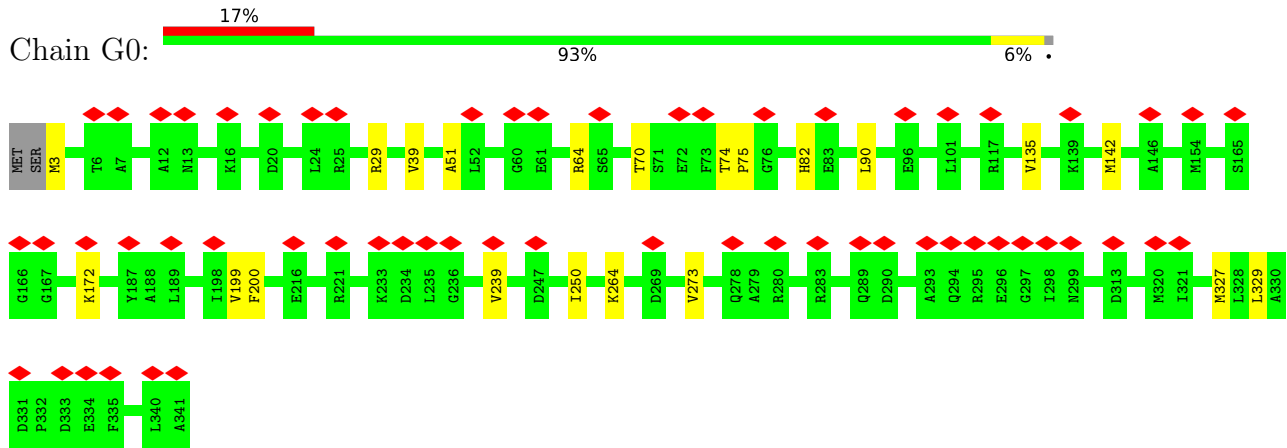

• Molecule 5: Major capsid protein

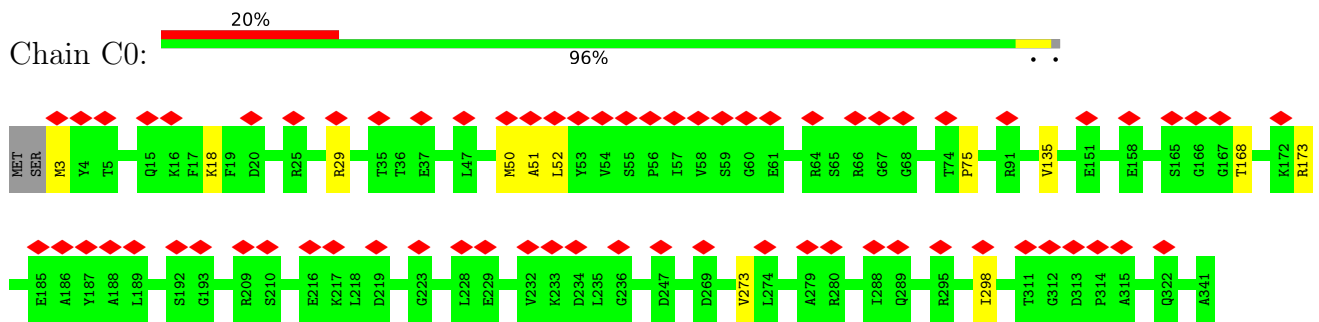

• Molecule 5: Major capsid protein

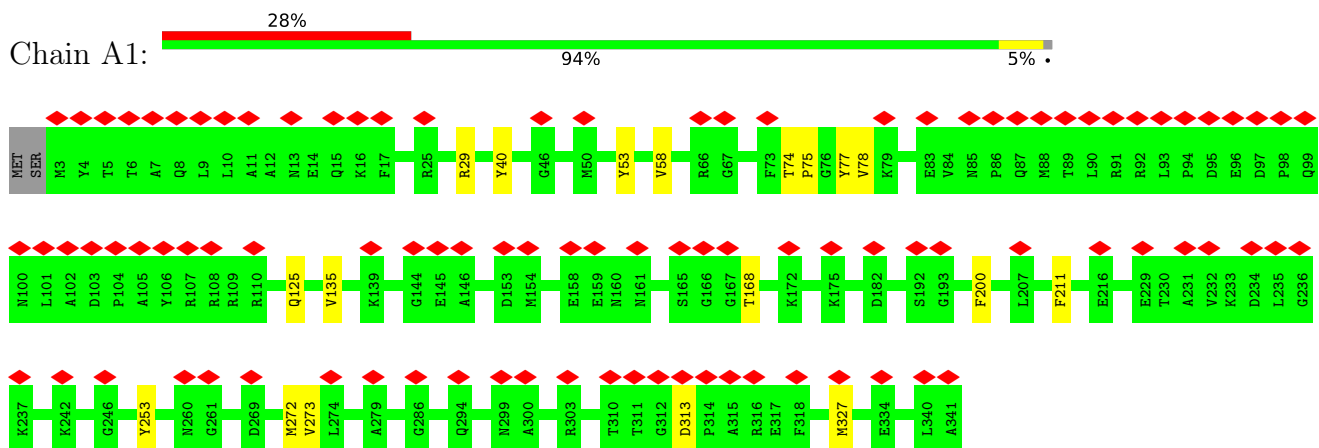

• Molecule 5: Major capsid protein

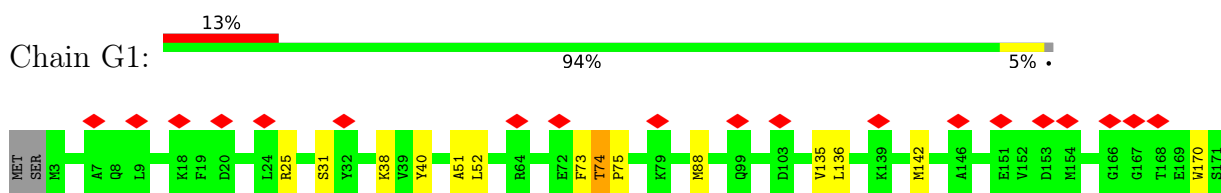

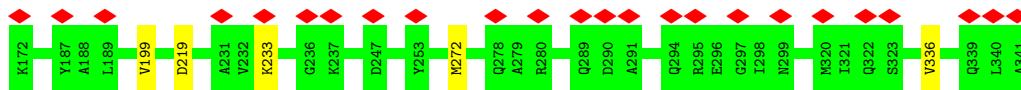

• Molecule 5: Major capsid protein

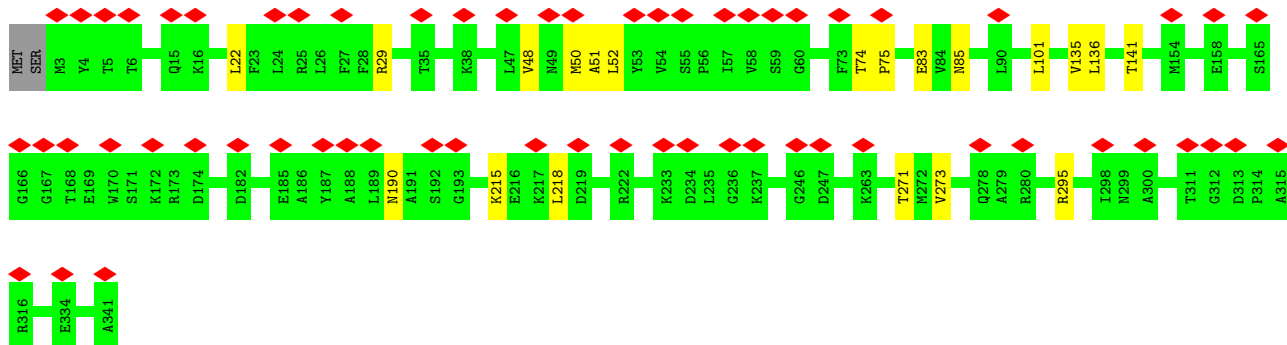

• Molecule 5: Major capsid protein

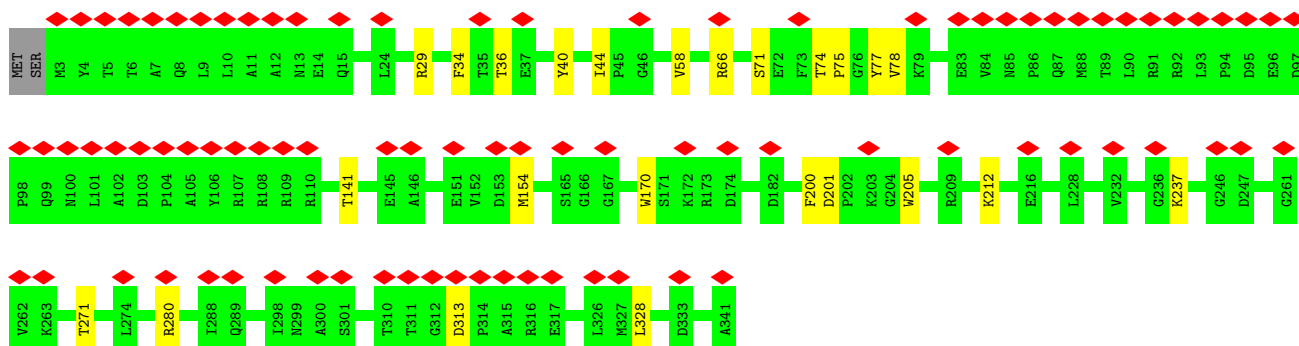
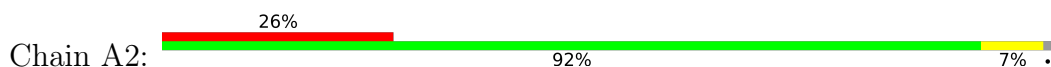

• Molecule 5: Major capsid protein

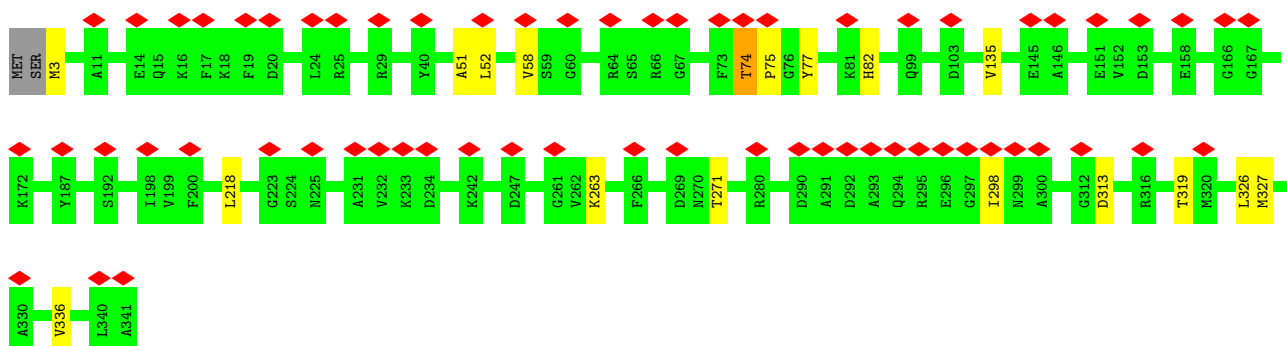

• Molecule 5: Major capsid protein

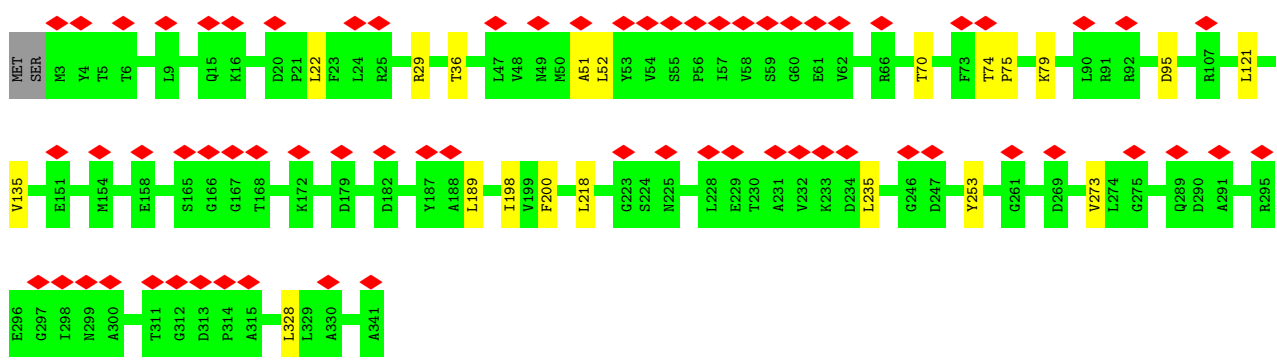

• Molecule 5: Major capsid protein

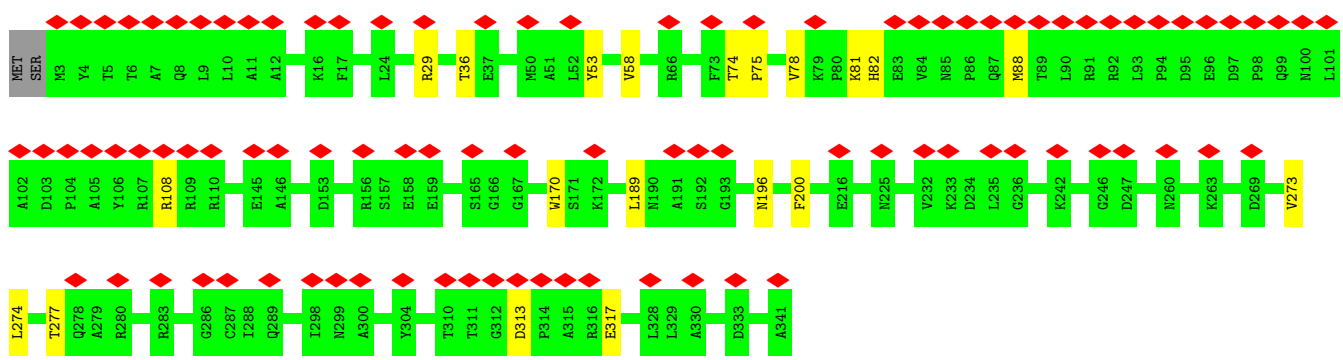

• Molecule 5: Major capsid protein

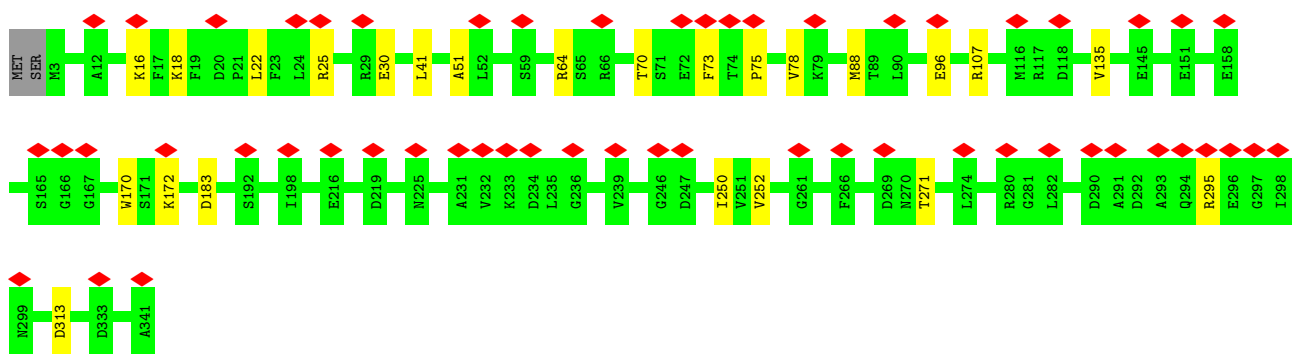
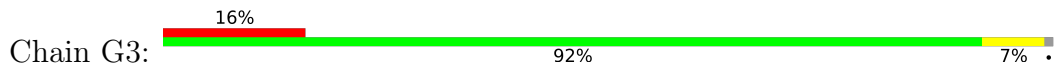

• Molecule 5: Major capsid protein

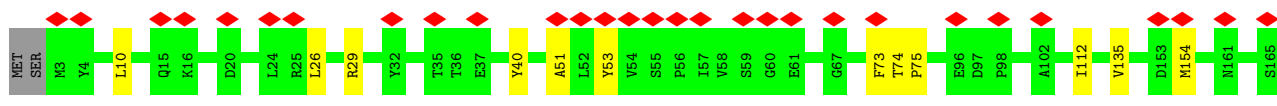
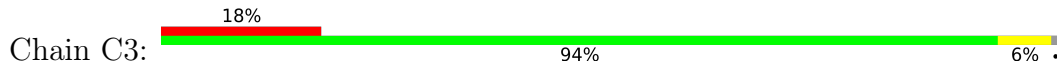

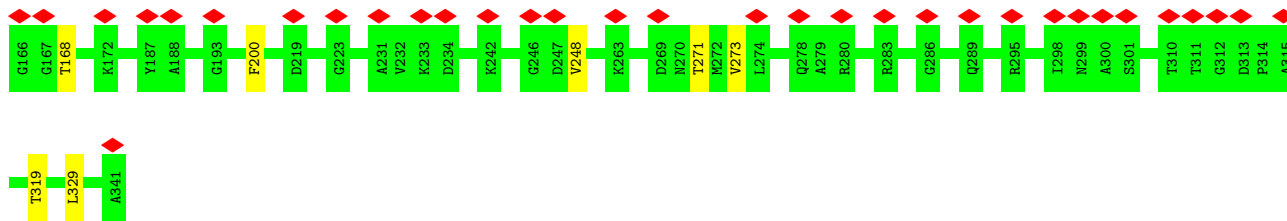

• Molecule 5: Major capsid protein

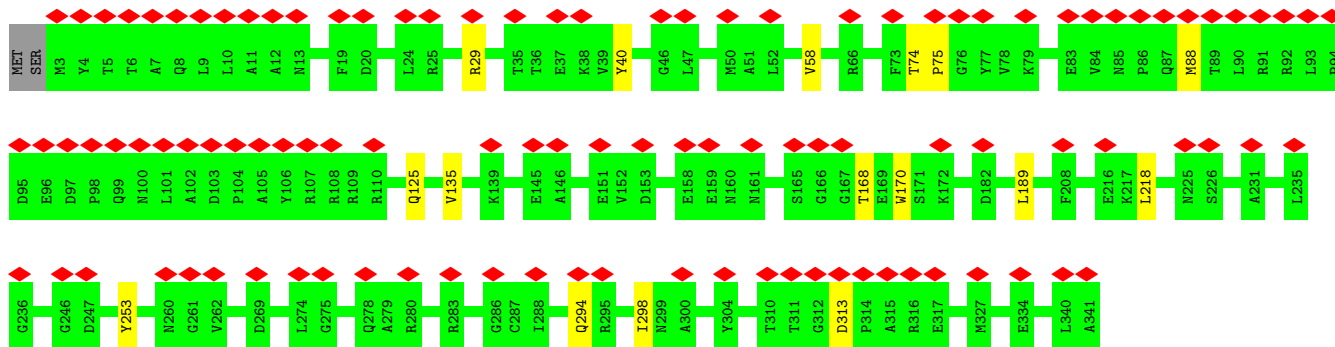

• Molecule 5: Major capsid protein

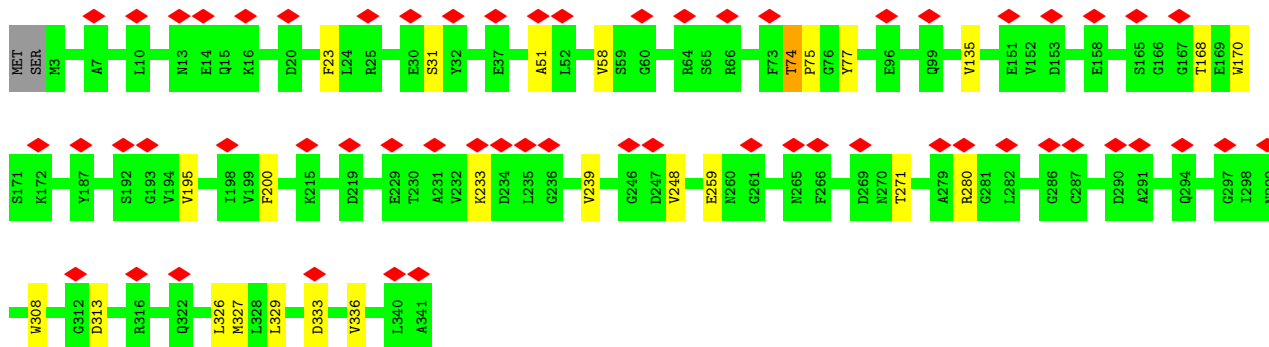
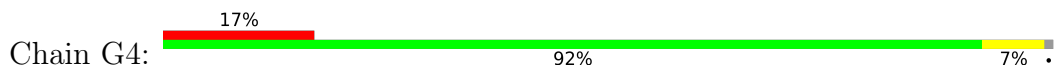

• Molecule 5: Major capsid protein

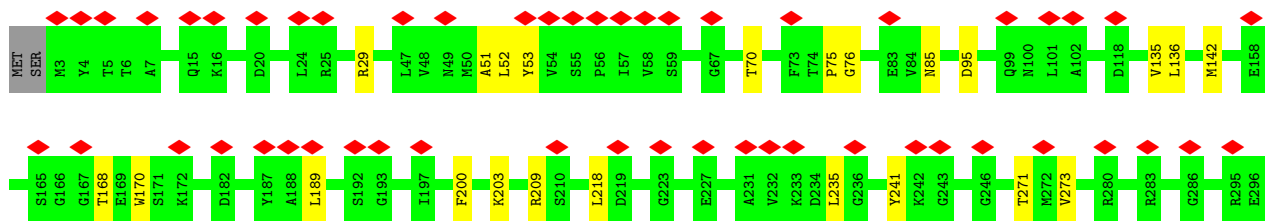
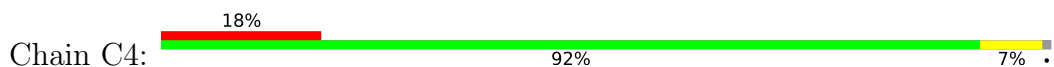

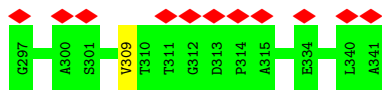

• Molecule 6: Capsid decoration protein

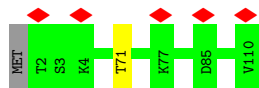

• Molecule 6: Capsid decoration protein

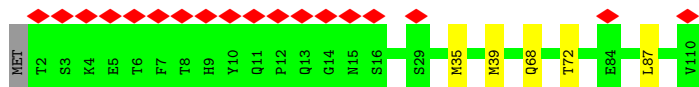

• Molecule 6: Capsid decoration protein

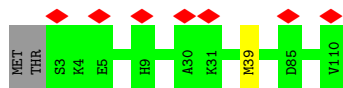

• Molecule 6: Capsid decoration protein

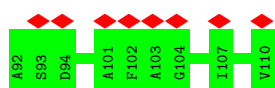
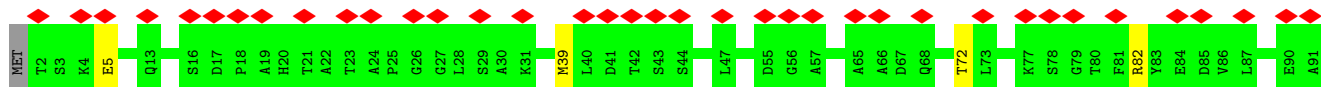
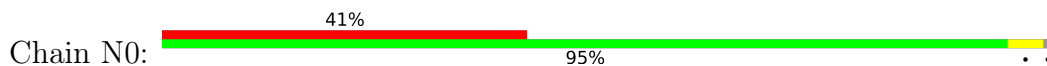

• Molecule 6: Capsid decoration protein

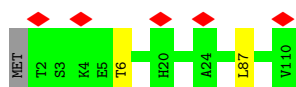

• Molecule 6: Capsid decoration protein



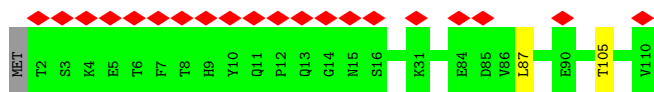

• Molecule 6: Capsid decoration protein

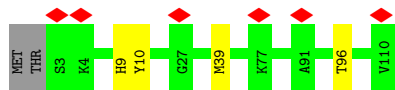

• Molecule 6: Capsid decoration protein

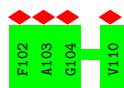
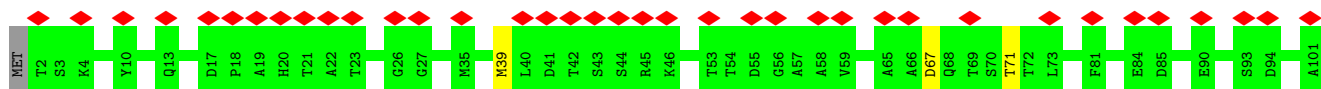

• Molecule 6: Capsid decoration protein

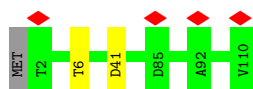

• Molecule 6: Capsid decoration protein

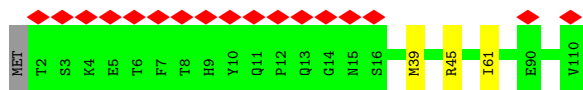

• Molecule 6: Capsid decoration protein

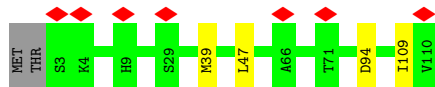

• Molecule 6: Capsid decoration protein

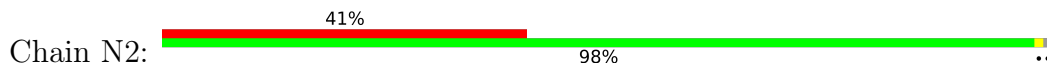

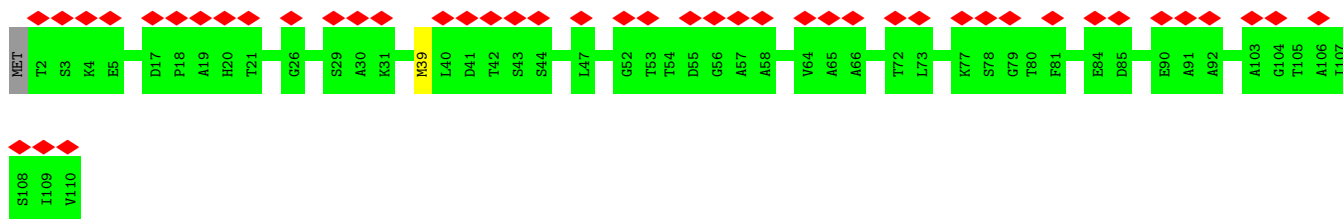

• Molecule 6: Capsid decoration protein

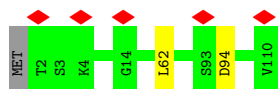

• Molecule 6: Capsid decoration protein

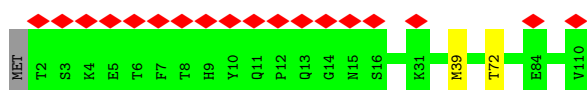

• Molecule 6: Capsid decoration protein

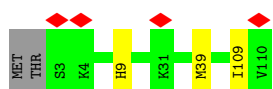

• Molecule 6: Capsid decoration protein

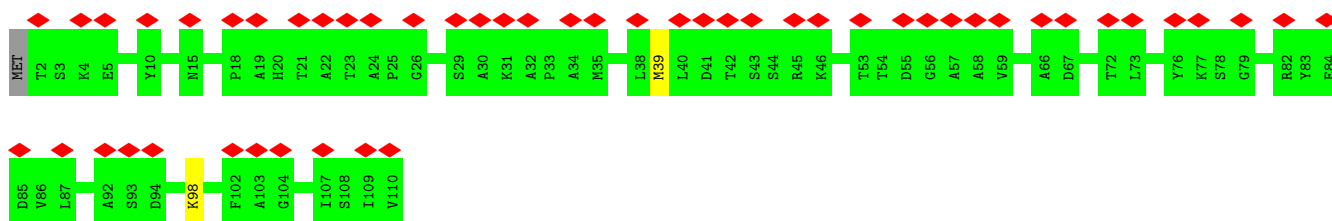

• Molecule 6: Capsid decoration protein



• Molecule 6: Capsid decoration protein

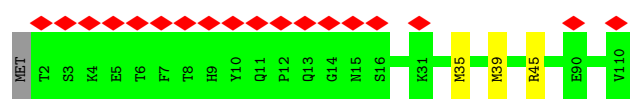

● Molecule 6: Capsid decoration protein

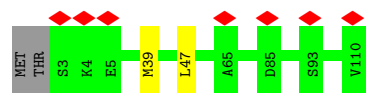

● Molecule 6: Capsid decoration protein

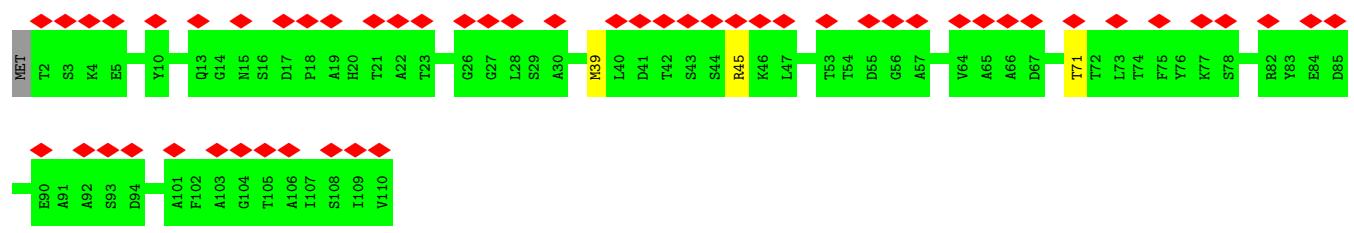

4 Experimental information

Property	Value	Source
EM reconstruction method	SINGLE PARTICLE	Depositor
Imposed symmetry	POINT, Not provided	
Number of particles used	9851	Depositor
Resolution determination method	FSC 0.143 CUT-OFF	Depositor
CTF correction method	NONE	Depositor
Microscope	FEI TITAN KRIOS	Depositor
Voltage (kV)	300	Depositor
Electron dose ($e^-/\text{\AA}^2$)	50	Depositor
Minimum defocus (nm)	1000	Depositor
Maximum defocus (nm)	2000	Depositor
Magnification	Not provided	
Image detector	GATAN K2 SUMMIT (4k x 4k)	Depositor
Maximum map value	0.954	Depositor
Minimum map value	-0.571	Depositor
Average map value	0.000	Depositor
Map value standard deviation	0.101	Depositor
Recommended contour level	0.3	Depositor
Map size (\AA)	343.74402, 343.74402, 343.74402	wwPDB
Map dimensions	320, 320, 320	wwPDB
Map angles ($^\circ$)	90.0, 90.0, 90.0	wwPDB
Pixel spacing (\AA)	1.0742, 1.0742, 1.0742	Depositor

5 Model quality [i](#)

5.1 Standard geometry [i](#)

The Z score for a bond length (or angle) is the number of standard deviations the observed value is removed from the expected value. A bond length (or angle) with $|Z| > 5$ is considered an outlier worth inspection. RMSZ is the root-mean-square of all Z scores of the bond lengths (or angles).

Mol	Chain	Bond lengths		Bond angles	
		RMSZ	# Z >5	RMSZ	# Z >5
1	f	0.27	0/888	0.58	0/1204
1	f1	0.26	0/888	0.57	0/1204
1	f2	0.27	0/888	0.58	0/1204
1	f3	0.26	0/888	0.56	0/1204
1	f4	0.26	0/888	0.57	0/1204
1	f5	0.26	0/888	0.57	0/1204
2	W	0.27	0/529	0.58	0/709
2	W1	0.26	0/529	0.56	0/709
2	W2	0.26	0/529	0.59	0/709
2	W3	0.27	0/529	0.59	0/709
2	W4	0.27	0/529	0.58	0/709
2	W5	0.27	0/529	0.62	0/709
2	w	0.27	0/529	0.60	0/709
2	w1	0.27	0/529	0.58	0/709
2	w2	0.29	0/529	0.62	0/709
2	w3	0.28	0/529	0.57	0/709
2	w4	0.28	0/529	0.59	0/709
2	w5	0.28	0/529	0.63	0/709
3	U	0.26	0/1058	0.49	0/1444
3	U1	0.26	0/1058	0.52	0/1444
3	U2	0.28	0/1058	0.50	0/1444
3	U3	0.28	0/1058	0.53	0/1444
3	U4	0.27	0/1058	0.51	0/1444
3	U5	0.27	0/1058	0.50	0/1444
4	B	0.27	0/3811	0.50	0/5151
4	B1	0.27	0/3811	0.51	0/5151
4	B2	0.27	0/3811	0.51	0/5151
4	B3	0.27	0/3811	0.50	0/5151
4	B4	0.27	0/3811	0.51	0/5151
4	B5	0.27	0/3811	0.51	0/5151
4	b	0.27	0/3793	0.50	0/5126
4	b1	0.27	0/3793	0.50	0/5126
4	b2	0.27	0/3793	0.50	0/5126
4	b3	0.27	0/3793	0.50	0/5126

Mol	Chain	Bond lengths		Bond angles	
		RMSZ	# Z >5	RMSZ	# Z >5
4	b4	0.27	0/3793	0.51	0/5126
4	b5	0.27	0/3793	0.50	0/5126
5	A0	0.27	0/2722	0.52	0/3685
5	A1	0.27	0/2722	0.52	0/3685
5	A2	0.27	0/2722	0.52	0/3685
5	A3	0.27	0/2722	0.52	0/3685
5	A4	0.27	0/2722	0.51	0/3685
5	C0	0.28	0/2722	0.53	0/3685
5	C1	0.28	0/2722	0.53	0/3685
5	C2	0.27	0/2722	0.53	0/3685
5	C3	0.28	0/2722	0.53	0/3685
5	C4	0.27	0/2722	0.53	0/3685
5	G0	0.28	0/2722	0.53	0/3685
5	G1	0.28	0/2722	0.54	0/3685
5	G2	0.28	0/2722	0.53	0/3685
5	G3	0.28	0/2722	0.53	0/3685
5	G4	0.28	0/2722	0.53	0/3685
6	H0	0.27	0/832	0.48	0/1135
6	H1	0.27	0/832	0.48	0/1135
6	H2	0.27	0/832	0.48	0/1135
6	H3	0.27	0/832	0.47	0/1135
6	H4	0.27	0/832	0.49	0/1135
6	I0	0.27	0/832	0.51	0/1135
6	I1	0.27	0/832	0.49	0/1135
6	I2	0.27	0/832	0.51	0/1135
6	I3	0.27	0/832	0.50	0/1135
6	I4	0.27	0/832	0.50	0/1135
6	J0	0.27	0/825	0.48	0/1125
6	J1	0.27	0/825	0.48	0/1125
6	J2	0.27	0/825	0.48	0/1125
6	J3	0.26	0/825	0.48	0/1125
6	J4	0.27	0/825	0.49	0/1125
6	N0	0.26	0/832	0.49	0/1135
6	N1	0.26	0/832	0.48	0/1135
6	N2	0.26	0/832	0.49	0/1135
6	N3	0.26	0/832	0.48	0/1135
6	N4	0.26	0/832	0.48	0/1135
All	All	0.27	0/121083	0.52	0/163983

Chiral center outliers are detected by calculating the chiral volume of a chiral center and verifying if the center is modelled as a planar moiety or with the opposite hand. A planarity outlier is detected by checking planarity of atoms in a peptide group, atoms in a mainchain group or atoms of a sidechain that are expected to be planar.

Mol	Chain	#Chirality outliers	#Planarity outliers
3	U	0	1
3	U1	0	1
3	U2	0	1
3	U3	0	1
3	U4	0	1
3	U5	0	1
5	A0	0	2
5	A1	0	2
5	A2	0	1
5	A3	0	1
5	A4	0	2
5	C0	0	2
5	C1	0	3
5	C2	0	3
5	C3	0	3
5	C4	0	2
5	G0	0	2
5	G1	0	2
5	G2	0	3
5	G3	0	2
5	G4	0	2
All	All	0	38

There are no bond length outliers.

There are no bond angle outliers.

There are no chirality outliers.

All (38) planarity outliers are listed below:

Mol	Chain	Res	Type	Group
5	A0	135	VAL	Peptide
5	A0	74	THR	Peptide
5	A1	135	VAL	Peptide
5	A1	74	THR	Peptide
5	A2	74	THR	Peptide
5	A3	74	THR	Peptide
5	A4	135	VAL	Peptide
5	A4	74	THR	Peptide
5	C0	135	VAL	Peptide
5	C0	51	ALA	Peptide
5	C1	135	VAL	Peptide
5	C1	51	ALA	Peptide
5	C1	74	THR	Peptide

Continued on next page...

Continued from previous page...

Mol	Chain	Res	Type	Group
5	C2	135	VAL	Peptide
5	C2	51	ALA	Peptide
5	C2	74	THR	Peptide
5	C3	135	VAL	Peptide
5	C3	51	ALA	Peptide
5	C3	74	THR	Peptide
5	C4	135	VAL	Peptide
5	C4	51	ALA	Peptide
5	G0	135	VAL	Peptide
5	G0	51	ALA	Peptide
5	G1	135	VAL	Peptide
5	G1	51	ALA	Peptide
5	G2	135	VAL	Peptide
5	G2	51	ALA	Peptide
5	G2	74	THR	Peptide
5	G3	135	VAL	Peptide
5	G3	51	ALA	Peptide
5	G4	135	VAL	Peptide
5	G4	51	ALA	Peptide
3	U	39	PHE	Peptide
3	U1	39	PHE	Peptide
3	U2	39	PHE	Peptide
3	U3	39	PHE	Peptide
3	U4	39	PHE	Peptide
3	U5	39	PHE	Peptide

5.2 Too-close contacts [i](#)

Due to software issues we are unable to calculate clashes - this section is therefore empty.

5.3 Torsion angles [i](#)

5.3.1 Protein backbone [i](#)

In the following table, the Percentiles column shows the percent Ramachandran outliers of the chain as a percentile score with respect to all PDB entries followed by that with respect to all EM entries.

The Analysed column shows the number of residues for which the backbone conformation was analysed, and the total number of residues.

Mol	Chain	Analysed	Favoured	Allowed	Outliers	Percentiles	
1	f	112/117 (96%)	96 (86%)	16 (14%)	0	100	100
1	f1	112/117 (96%)	92 (82%)	20 (18%)	0	100	100
1	f2	112/117 (96%)	93 (83%)	19 (17%)	0	100	100
1	f3	112/117 (96%)	93 (83%)	19 (17%)	0	100	100
1	f4	112/117 (96%)	94 (84%)	18 (16%)	0	100	100
1	f5	112/117 (96%)	92 (82%)	20 (18%)	0	100	100
2	W	65/68 (96%)	58 (89%)	6 (9%)	1 (2%)	8	40
2	W1	65/68 (96%)	62 (95%)	3 (5%)	0	100	100
2	W2	65/68 (96%)	59 (91%)	5 (8%)	1 (2%)	8	40
2	W3	65/68 (96%)	58 (89%)	6 (9%)	1 (2%)	8	40
2	W4	65/68 (96%)	62 (95%)	3 (5%)	0	100	100
2	W5	65/68 (96%)	60 (92%)	4 (6%)	1 (2%)	8	40
2	w	65/68 (96%)	60 (92%)	4 (6%)	1 (2%)	8	40
2	w1	65/68 (96%)	58 (89%)	7 (11%)	0	100	100
2	w2	65/68 (96%)	57 (88%)	7 (11%)	1 (2%)	8	40
2	w3	65/68 (96%)	57 (88%)	7 (11%)	1 (2%)	8	40
2	w4	65/68 (96%)	57 (88%)	7 (11%)	1 (2%)	8	40
2	w5	65/68 (96%)	59 (91%)	4 (6%)	2 (3%)	3	26
3	U	129/131 (98%)	108 (84%)	19 (15%)	2 (2%)	8	39
3	U1	129/131 (98%)	107 (83%)	20 (16%)	2 (2%)	8	39
3	U2	129/131 (98%)	108 (84%)	18 (14%)	3 (2%)	5	32
3	U3	129/131 (98%)	108 (84%)	18 (14%)	3 (2%)	5	32
3	U4	129/131 (98%)	108 (84%)	19 (15%)	2 (2%)	8	39
3	U5	129/131 (98%)	107 (83%)	21 (16%)	1 (1%)	16	53
4	B	471/533 (88%)	446 (95%)	24 (5%)	1 (0%)	44	76
4	B1	471/533 (88%)	441 (94%)	30 (6%)	0	100	100
4	B2	471/533 (88%)	443 (94%)	27 (6%)	1 (0%)	44	76
4	B3	471/533 (88%)	444 (94%)	26 (6%)	1 (0%)	44	76
4	B4	471/533 (88%)	441 (94%)	29 (6%)	1 (0%)	44	76
4	B5	471/533 (88%)	444 (94%)	26 (6%)	1 (0%)	44	76
4	b	469/533 (88%)	443 (94%)	26 (6%)	0	100	100
4	b1	469/533 (88%)	442 (94%)	27 (6%)	0	100	100

Continued on next page...

Continued from previous page...

Mol	Chain	Analysed	Favoured	Allowed	Outliers	Percentiles	
4	b2	469/533 (88%)	444 (95%)	25 (5%)	0	100	100
4	b3	469/533 (88%)	445 (95%)	24 (5%)	0	100	100
4	b4	469/533 (88%)	442 (94%)	26 (6%)	1 (0%)	44	76
4	b5	469/533 (88%)	437 (93%)	32 (7%)	0	100	100
5	A0	337/341 (99%)	292 (87%)	44 (13%)	1 (0%)	37	71
5	A1	337/341 (99%)	298 (88%)	38 (11%)	1 (0%)	37	71
5	A2	337/341 (99%)	289 (86%)	47 (14%)	1 (0%)	37	71
5	A3	337/341 (99%)	288 (86%)	48 (14%)	1 (0%)	37	71
5	A4	337/341 (99%)	294 (87%)	42 (12%)	1 (0%)	37	71
5	C0	337/341 (99%)	284 (84%)	52 (15%)	1 (0%)	37	71
5	C1	337/341 (99%)	288 (86%)	48 (14%)	1 (0%)	37	71
5	C2	337/341 (99%)	284 (84%)	52 (15%)	1 (0%)	37	71
5	C3	337/341 (99%)	284 (84%)	52 (15%)	1 (0%)	37	71
5	C4	337/341 (99%)	280 (83%)	55 (16%)	2 (1%)	22	59
5	G0	337/341 (99%)	290 (86%)	45 (13%)	2 (1%)	22	59
5	G1	337/341 (99%)	278 (82%)	57 (17%)	2 (1%)	22	59
5	G2	337/341 (99%)	286 (85%)	49 (14%)	2 (1%)	22	59
5	G3	337/341 (99%)	284 (84%)	52 (15%)	1 (0%)	37	71
5	G4	337/341 (99%)	284 (84%)	51 (15%)	2 (1%)	22	59
6	H0	108/110 (98%)	104 (96%)	4 (4%)	0	100	100
6	H1	108/110 (98%)	103 (95%)	5 (5%)	0	100	100
6	H2	108/110 (98%)	106 (98%)	2 (2%)	0	100	100
6	H3	108/110 (98%)	103 (95%)	5 (5%)	0	100	100
6	H4	108/110 (98%)	104 (96%)	4 (4%)	0	100	100
6	I0	108/110 (98%)	102 (94%)	6 (6%)	0	100	100
6	I1	108/110 (98%)	106 (98%)	2 (2%)	0	100	100
6	I2	108/110 (98%)	104 (96%)	4 (4%)	0	100	100
6	I3	108/110 (98%)	100 (93%)	8 (7%)	0	100	100
6	I4	108/110 (98%)	103 (95%)	5 (5%)	0	100	100
6	J0	107/110 (97%)	101 (94%)	6 (6%)	0	100	100
6	J1	107/110 (97%)	102 (95%)	5 (5%)	0	100	100

Continued on next page...

Continued from previous page...

Mol	Chain	Analysed	Favoured	Allowed	Outliers	Percentiles	
6	J2	107/110 (97%)	105 (98%)	2 (2%)	0	100	100
6	J3	107/110 (97%)	102 (95%)	5 (5%)	0	100	100
6	J4	107/110 (97%)	104 (97%)	3 (3%)	0	100	100
6	N0	108/110 (98%)	102 (94%)	6 (6%)	0	100	100
6	N1	108/110 (98%)	101 (94%)	7 (6%)	0	100	100
6	N2	108/110 (98%)	103 (95%)	5 (5%)	0	100	100
6	N3	108/110 (98%)	105 (97%)	3 (3%)	0	100	100
6	N4	108/110 (98%)	102 (94%)	6 (6%)	0	100	100
All	All	15076/16015 (94%)	13590 (90%)	1437 (10%)	49 (0%)	38	71

All (49) Ramachandran outliers are listed below:

Mol	Chain	Res	Type
2	W	63	PRO
2	w	63	PRO
3	U	30	ARG
2	W2	63	PRO
2	w2	63	PRO
3	U2	33	VAL
2	W3	63	PRO
2	w3	63	PRO
3	U3	30	ARG
2	w4	63	PRO
2	W5	63	PRO
2	w5	63	PRO
5	G0	75	PRO
4	b4	34	GLN
5	G1	75	PRO
5	G2	75	PRO
5	G3	75	PRO
5	G4	75	PRO
3	U2	32	ALA
3	U4	30	ARG
4	B5	328	ALA
5	G0	74	THR
5	C0	75	PRO
5	C1	75	PRO
5	G2	74	THR
4	B4	328	ALA

Continued on next page...

Continued from previous page...

Mol	Chain	Res	Type
5	C2	75	PRO
5	A3	75	PRO
5	C4	75	PRO
3	U	33	VAL
4	B2	328	ALA
3	U3	33	VAL
3	U4	33	VAL
3	U5	33	VAL
5	A0	75	PRO
5	C3	75	PRO
5	G4	74	THR
4	B	34	GLN
3	U1	32	ALA
3	U1	33	VAL
4	B3	328	ALA
2	w5	20	GLY
5	A1	75	PRO
5	A2	75	PRO
5	A4	75	PRO
3	U2	40	PRO
3	U3	40	PRO
5	G1	74	THR
5	C4	76	GLY

5.3.2 Protein sidechains [i](#)

In the following table, the Percentiles column shows the percent sidechain outliers of the chain as a percentile score with respect to all PDB entries followed by that with respect to all EM entries.

The Analysed column shows the number of residues for which the sidechain conformation was analysed, and the total number of residues.

Mol	Chain	Analysed	Rotameric	Outliers	Percentiles
1	f	91/94 (97%)	87 (96%)	4 (4%)	24 47
1	f1	91/94 (97%)	90 (99%)	1 (1%)	70 80
1	f2	91/94 (97%)	88 (97%)	3 (3%)	33 55
1	f3	91/94 (97%)	84 (92%)	7 (8%)	10 33
1	f4	91/94 (97%)	89 (98%)	2 (2%)	47 66
1	f5	91/94 (97%)	89 (98%)	2 (2%)	47 66

Continued on next page...

Continued from previous page...

Mol	Chain	Analysed	Rotameric	Outliers	Percentiles	
2	W	53/54 (98%)	52 (98%)	1 (2%)	52	70
2	W1	53/54 (98%)	51 (96%)	2 (4%)	28	51
2	W2	53/54 (98%)	48 (91%)	5 (9%)	7	25
2	W3	53/54 (98%)	50 (94%)	3 (6%)	17	41
2	W4	53/54 (98%)	46 (87%)	7 (13%)	3	17
2	W5	53/54 (98%)	53 (100%)	0	100	100
2	w	53/54 (98%)	51 (96%)	2 (4%)	28	51
2	w1	53/54 (98%)	50 (94%)	3 (6%)	17	41
2	w2	53/54 (98%)	51 (96%)	2 (4%)	28	51
2	w3	53/54 (98%)	52 (98%)	1 (2%)	52	70
2	w4	53/54 (98%)	51 (96%)	2 (4%)	28	51
2	w5	53/54 (98%)	50 (94%)	3 (6%)	17	41
3	U	109/109 (100%)	104 (95%)	5 (5%)	23	46
3	U1	109/109 (100%)	106 (97%)	3 (3%)	38	60
3	U2	109/109 (100%)	105 (96%)	4 (4%)	29	52
3	U3	109/109 (100%)	101 (93%)	8 (7%)	11	34
3	U4	109/109 (100%)	105 (96%)	4 (4%)	29	52
3	U5	109/109 (100%)	106 (97%)	3 (3%)	38	60
4	B	381/428 (89%)	363 (95%)	18 (5%)	22	46
4	B1	381/428 (89%)	362 (95%)	19 (5%)	20	44
4	B2	381/428 (89%)	365 (96%)	16 (4%)	25	49
4	B3	381/428 (89%)	369 (97%)	12 (3%)	35	56
4	B4	381/428 (89%)	370 (97%)	11 (3%)	37	59
4	B5	381/428 (89%)	369 (97%)	12 (3%)	35	56
4	b	380/428 (89%)	366 (96%)	14 (4%)	29	52
4	b1	380/428 (89%)	363 (96%)	17 (4%)	23	47
4	b2	380/428 (89%)	372 (98%)	8 (2%)	48	67
4	b3	380/428 (89%)	367 (97%)	13 (3%)	32	54
4	b4	380/428 (89%)	368 (97%)	12 (3%)	34	56
4	b5	380/428 (89%)	367 (97%)	13 (3%)	32	54
5	A0	288/290 (99%)	275 (96%)	13 (4%)	23	47

Continued on next page...

Continued from previous page...

Mol	Chain	Analysed	Rotameric	Outliers	Percentiles	
5	A1	288/290 (99%)	273 (95%)	15 (5%)	19	43
5	A2	288/290 (99%)	266 (92%)	22 (8%)	11	33
5	A3	288/290 (99%)	270 (94%)	18 (6%)	15	38
5	A4	288/290 (99%)	275 (96%)	13 (4%)	23	47
5	C0	288/290 (99%)	279 (97%)	9 (3%)	35	56
5	C1	288/290 (99%)	272 (94%)	16 (6%)	17	41
5	C2	288/290 (99%)	272 (94%)	16 (6%)	17	41
5	C3	288/290 (99%)	273 (95%)	15 (5%)	19	43
5	C4	288/290 (99%)	268 (93%)	20 (7%)	13	35
5	G0	288/290 (99%)	271 (94%)	17 (6%)	16	40
5	G1	288/290 (99%)	272 (94%)	16 (6%)	17	41
5	G2	288/290 (99%)	274 (95%)	14 (5%)	21	44
5	G3	288/290 (99%)	267 (93%)	21 (7%)	11	34
5	G4	288/290 (99%)	266 (92%)	22 (8%)	11	33
6	H0	85/85 (100%)	84 (99%)	1 (1%)	67	79
6	H1	85/85 (100%)	83 (98%)	2 (2%)	44	63
6	H2	85/85 (100%)	83 (98%)	2 (2%)	44	63
6	H3	85/85 (100%)	83 (98%)	2 (2%)	44	63
6	H4	85/85 (100%)	79 (93%)	6 (7%)	12	35
6	I0	85/85 (100%)	80 (94%)	5 (6%)	16	40
6	I1	85/85 (100%)	83 (98%)	2 (2%)	44	63
6	I2	85/85 (100%)	82 (96%)	3 (4%)	31	53
6	I3	85/85 (100%)	83 (98%)	2 (2%)	44	63
6	I4	85/85 (100%)	82 (96%)	3 (4%)	31	53
6	J0	84/85 (99%)	83 (99%)	1 (1%)	67	79
6	J1	84/85 (99%)	80 (95%)	4 (5%)	21	45
6	J2	84/85 (99%)	79 (94%)	5 (6%)	16	39
6	J3	84/85 (99%)	81 (96%)	3 (4%)	30	53
6	J4	84/85 (99%)	81 (96%)	3 (4%)	30	53
6	N0	85/85 (100%)	81 (95%)	4 (5%)	22	46
6	N1	85/85 (100%)	82 (96%)	3 (4%)	31	53

Continued on next page...

Continued from previous page...

Mol	Chain	Analysed	Rotameric	Outliers	Percentiles	
6	N2	85/85 (100%)	84 (99%)	1 (1%)	67	79
6	N3	85/85 (100%)	83 (98%)	2 (2%)	44	63
6	N4	85/85 (100%)	82 (96%)	3 (4%)	31	53
All	All	12417/13052 (95%)	11871 (96%)	546 (4%)	26	47

All (546) residues with a non-rotameric sidechain are listed below:

Mol	Chain	Res	Type
1	f	58	VAL
1	f	65	LEU
1	f	72	VAL
1	f	116	ARG
2	W	50	LEU
2	w	17	LEU
2	w	18	MET
3	U	19	LYS
3	U	39	PHE
3	U	56	LEU
3	U	74	GLN
3	U	129	VAL
4	B	35	LEU
4	B	54	THR
4	B	63	LEU
4	B	78	GLN
4	B	82	VAL
4	B	133	THR
4	B	153	VAL
4	B	258	MET
4	B	330	VAL
4	B	349	ASN
4	B	381	SER
4	B	384	THR
4	B	410	GLN
4	B	414	CYS
4	B	423	ARG
4	B	425	VAL
4	B	467	LEU
4	B	495	ARG
4	b	35	LEU
4	b	77	HIS
4	b	171	MET

Continued on next page...

Continued from previous page...

Mol	Chain	Res	Type
4	b	207	SER
4	b	241	GLU
4	b	255	MET
4	b	258	MET
4	b	261	LEU
4	b	266	ASN
4	b	369	SER
4	b	384	THR
4	b	453	MET
4	b	459	LYS
4	b	467	LEU
1	f1	75	LEU
2	W1	23	VAL
2	W1	39	SER
2	w1	7	LEU
2	w1	28	LYS
2	w1	36	THR
3	U1	19	LYS
3	U1	52	THR
3	U1	105	MET
4	B1	35	LEU
4	B1	82	VAL
4	B1	91	ARG
4	B1	116	LYS
4	B1	130	ARG
4	B1	147	PHE
4	B1	151	LEU
4	B1	167	THR
4	B1	181	ASN
4	B1	190	ARG
4	B1	202	LEU
4	B1	208	GLU
4	B1	215	MET
4	B1	261	LEU
4	B1	264	LEU
4	B1	325	LEU
4	B1	330	VAL
4	B1	384	THR
4	B1	453	MET
4	b1	34	GLN
4	b1	35	LEU
4	b1	63	LEU

Continued on next page...

Continued from previous page...

Mol	Chain	Res	Type
4	b1	215	MET
4	b1	224	ARG
4	b1	236	VAL
4	b1	255	MET
4	b1	261	LEU
4	b1	355	GLU
4	b1	356	GLN
4	b1	373	LEU
4	b1	386	ARG
4	b1	407	GLN
4	b1	410	GLN
4	b1	453	MET
4	b1	474	THR
4	b1	481	LYS
1	f2	7	LEU
1	f2	42	VAL
1	f2	113	VAL
2	W2	18	MET
2	W2	23	VAL
2	W2	26	VAL
2	W2	33	VAL
2	W2	50	LEU
2	w2	23	VAL
2	w2	32	ARG
3	U2	19	LYS
3	U2	39	PHE
3	U2	50	GLU
3	U2	114	ARG
4	B2	35	LEU
4	B2	82	VAL
4	B2	88	LEU
4	B2	123	CYS
4	B2	125	CYS
4	B2	144	MET
4	B2	226	LEU
4	B2	240	VAL
4	B2	255	MET
4	B2	258	MET
4	B2	330	VAL
4	B2	341	LEU
4	B2	349	ASN
4	B2	356	GLN

Continued on next page...

Continued from previous page...

Mol	Chain	Res	Type
4	B2	371	GLU
4	B2	467	LEU
4	b2	35	LEU
4	b2	172	VAL
4	b2	237	PHE
4	b2	255	MET
4	b2	273	ILE
4	b2	286	LEU
4	b2	355	GLU
4	b2	448	ILE
1	f3	42	VAL
1	f3	48	ASN
1	f3	58	VAL
1	f3	72	VAL
1	f3	80	THR
1	f3	81	LEU
1	f3	113	VAL
2	W3	25	THR
2	W3	27	GLN
2	W3	39	SER
2	w3	36	THR
3	U3	19	LYS
3	U3	27	PHE
3	U3	39	PHE
3	U3	84	MET
3	U3	128	TYR
3	U3	130	ILE
3	U3	131	THR
3	U3	134	MET
4	B3	35	LEU
4	B3	151	LEU
4	B3	153	VAL
4	B3	171	MET
4	B3	173	SER
4	B3	202	LEU
4	B3	206	VAL
4	B3	258	MET
4	B3	330	VAL
4	B3	334	MET
4	B3	359	LEU
4	B3	467	LEU
4	b3	35	LEU

Continued on next page...

Continued from previous page...

Mol	Chain	Res	Type
4	b3	43	GLU
4	b3	82	VAL
4	b3	116	LYS
4	b3	140	GLU
4	b3	171	MET
4	b3	218	LYS
4	b3	240	VAL
4	b3	273	ILE
4	b3	324	ARG
4	b3	355	GLU
4	b3	453	MET
4	b3	474	THR
1	f4	42	VAL
1	f4	75	LEU
2	W4	7	LEU
2	W4	14	LEU
2	W4	19	THR
2	W4	23	VAL
2	W4	26	VAL
2	W4	34	GLU
2	W4	36	THR
2	w4	2	THR
2	w4	58	GLN
3	U4	14	LEU
3	U4	22	THR
3	U4	50	GLU
3	U4	92	MET
4	B4	35	LEU
4	B4	82	VAL
4	B4	123	CYS
4	B4	129	GLU
4	B4	158	ASP
4	B4	171	MET
4	B4	255	MET
4	B4	261	LEU
4	B4	286	LEU
4	B4	411	MET
4	B4	462	GLN
4	b4	35	LEU
4	b4	170	ARG
4	b4	241	GLU
4	b4	255	MET

Continued on next page...

Continued from previous page...

Mol	Chain	Res	Type
4	b4	338	SER
4	b4	346	ASP
4	b4	354	PHE
4	b4	391	GLU
4	b4	458	LEU
4	b4	474	THR
4	b4	478	GLU
4	b4	486	TYR
1	f5	39	ILE
1	f5	75	LEU
2	w5	2	THR
2	w5	29	ASP
2	w5	34	GLU
3	U5	20	HIS
3	U5	42	VAL
3	U5	62	GLN
4	B5	35	LEU
4	B5	78	GLN
4	B5	171	MET
4	B5	269	LEU
4	B5	273	ILE
4	B5	330	VAL
4	B5	359	LEU
4	B5	366	LEU
4	B5	370	TYR
4	B5	498	MET
4	B5	501	ARG
4	B5	505	LEU
4	b5	35	LEU
4	b5	86	PHE
4	b5	109	ARG
4	b5	137	MET
4	b5	138	ILE
4	b5	259	LYS
4	b5	273	ILE
4	b5	277	MET
4	b5	323	VAL
4	b5	330	VAL
4	b5	341	LEU
4	b5	359	LEU
4	b5	466	MET
5	A0	37	GLU

Continued on next page...

Continued from previous page...

Mol	Chain	Res	Type
5	A0	40	TYR
5	A0	44	ILE
5	A0	58	VAL
5	A0	73	PHE
5	A0	81	LYS
5	A0	82	HIS
5	A0	88	MET
5	A0	103	ASP
5	A0	197	ILE
5	A0	211	PHE
5	A0	253	TYR
5	A0	328	LEU
5	G0	3	MET
5	G0	29	ARG
5	G0	39	VAL
5	G0	64	ARG
5	G0	70	THR
5	G0	82	HIS
5	G0	90	LEU
5	G0	142	MET
5	G0	172	LYS
5	G0	199	VAL
5	G0	200	PHE
5	G0	239	VAL
5	G0	250	ILE
5	G0	264	LYS
5	G0	273	VAL
5	G0	327	MET
5	G0	329	LEU
5	C0	3	MET
5	C0	18	LYS
5	C0	29	ARG
5	C0	50	MET
5	C0	52	LEU
5	C0	168	THR
5	C0	173	ARG
5	C0	273	VAL
5	C0	298	ILE
6	H0	71	THR
6	I0	35	MET
6	I0	39	MET
6	I0	68	GLN

Continued on next page...

Continued from previous page...

Mol	Chain	Res	Type
6	I0	72	THR
6	I0	87	LEU
6	J0	39	MET
6	N0	5	GLU
6	N0	39	MET
6	N0	72	THR
6	N0	82	ARG
5	A1	29	ARG
5	A1	40	TYR
5	A1	53	TYR
5	A1	58	VAL
5	A1	77	TYR
5	A1	78	VAL
5	A1	125	GLN
5	A1	168	THR
5	A1	200	PHE
5	A1	211	PHE
5	A1	253	TYR
5	A1	272	MET
5	A1	273	VAL
5	A1	313	ASP
5	A1	327	MET
5	G1	25	ARG
5	G1	31	SER
5	G1	38	LYS
5	G1	40	TYR
5	G1	52	LEU
5	G1	73	PHE
5	G1	74	THR
5	G1	88	MET
5	G1	136	LEU
5	G1	142	MET
5	G1	170	TRP
5	G1	199	VAL
5	G1	219	ASP
5	G1	233	LYS
5	G1	272	MET
5	G1	336	VAL
5	C1	22	LEU
5	C1	29	ARG
5	C1	48	VAL
5	C1	50	MET

Continued on next page...

Continued from previous page...

Mol	Chain	Res	Type
5	C1	52	LEU
5	C1	83	GLU
5	C1	85	ASN
5	C1	101	LEU
5	C1	136	LEU
5	C1	141	THR
5	C1	190	ASN
5	C1	215	LYS
5	C1	218	LEU
5	C1	271	THR
5	C1	273	VAL
5	C1	295	ARG
6	H1	6	THR
6	H1	87	LEU
6	I1	87	LEU
6	I1	105	THR
6	J1	9	HIS
6	J1	10	TYR
6	J1	39	MET
6	J1	96	THR
6	N1	39	MET
6	N1	67	ASP
6	N1	71	THR
5	A2	29	ARG
5	A2	34	PHE
5	A2	36	THR
5	A2	40	TYR
5	A2	44	ILE
5	A2	58	VAL
5	A2	66	ARG
5	A2	71	SER
5	A2	77	TYR
5	A2	78	VAL
5	A2	141	THR
5	A2	154	MET
5	A2	170	TRP
5	A2	200	PHE
5	A2	201	ASP
5	A2	205	TRP
5	A2	212	LYS
5	A2	237	LYS
5	A2	271	THR

Continued on next page...

Continued from previous page...

Mol	Chain	Res	Type
5	A2	280	ARG
5	A2	313	ASP
5	A2	328	LEU
5	G2	3	MET
5	G2	52	LEU
5	G2	58	VAL
5	G2	77	TYR
5	G2	82	HIS
5	G2	218	LEU
5	G2	263	LYS
5	G2	271	THR
5	G2	298	ILE
5	G2	313	ASP
5	G2	319	THR
5	G2	326	LEU
5	G2	327	MET
5	G2	336	VAL
5	C2	22	LEU
5	C2	29	ARG
5	C2	36	THR
5	C2	52	LEU
5	C2	70	THR
5	C2	79	LYS
5	C2	95	ASP
5	C2	121	LEU
5	C2	189	LEU
5	C2	198	ILE
5	C2	200	PHE
5	C2	218	LEU
5	C2	235	LEU
5	C2	253	TYR
5	C2	273	VAL
5	C2	328	LEU
6	H2	6	THR
6	H2	41	ASP
6	I2	39	MET
6	I2	45	ARG
6	I2	61	ILE
6	J2	39	MET
6	J2	47[A]	LEU
6	J2	47[B]	LEU
6	J2	94	ASP

Continued on next page...

Continued from previous page...

Mol	Chain	Res	Type
6	J2	109	ILE
6	N2	39	MET
5	A3	29	ARG
5	A3	36	THR
5	A3	53	TYR
5	A3	58	VAL
5	A3	78	VAL
5	A3	81	LYS
5	A3	82	HIS
5	A3	88	MET
5	A3	108	ARG
5	A3	170	TRP
5	A3	189	LEU
5	A3	196	ASN
5	A3	200	PHE
5	A3	273	VAL
5	A3	274	LEU
5	A3	277	THR
5	A3	313	ASP
5	A3	317	GLU
5	G3	16	LYS
5	G3	18	LYS
5	G3	22	LEU
5	G3	25	ARG
5	G3	30	GLU
5	G3	41	LEU
5	G3	64	ARG
5	G3	70	THR
5	G3	73	PHE
5	G3	78	VAL
5	G3	88	MET
5	G3	96	GLU
5	G3	107	ARG
5	G3	170	TRP
5	G3	172	LYS
5	G3	183	ASP
5	G3	250	ILE
5	G3	252	VAL
5	G3	271	THR
5	G3	295	ARG
5	G3	313	ASP
5	C3	10	LEU

Continued on next page...

Continued from previous page...

Mol	Chain	Res	Type
5	C3	26	LEU
5	C3	29	ARG
5	C3	40	TYR
5	C3	53	TYR
5	C3	73	PHE
5	C3	112	ILE
5	C3	154	MET
5	C3	168	THR
5	C3	200	PHE
5	C3	248	VAL
5	C3	271	THR
5	C3	273	VAL
5	C3	319	THR
5	C3	329	LEU
6	H3	62	LEU
6	H3	94	ASP
6	I3	39	MET
6	I3	72	THR
6	J3	9	HIS
6	J3	39	MET
6	J3	109	ILE
6	N3	39	MET
6	N3	98	LYS
5	A4	29	ARG
5	A4	40	TYR
5	A4	58	VAL
5	A4	88	MET
5	A4	125	GLN
5	A4	168	THR
5	A4	170	TRP
5	A4	189	LEU
5	A4	218	LEU
5	A4	253	TYR
5	A4	294	GLN
5	A4	298	ILE
5	A4	313	ASP
5	G4	23	PHE
5	G4	31	SER
5	G4	58	VAL
5	G4	74	THR
5	G4	77	TYR
5	G4	168	THR

Continued on next page...

Continued from previous page...

Mol	Chain	Res	Type
5	G4	170	TRP
5	G4	195	VAL
5	G4	200	PHE
5	G4	233	LYS
5	G4	239	VAL
5	G4	248	VAL
5	G4	259	GLU
5	G4	271	THR
5	G4	280	ARG
5	G4	308	TRP
5	G4	313	ASP
5	G4	326	LEU
5	G4	327	MET
5	G4	329	LEU
5	G4	333	ASP
5	G4	336	VAL
5	C4	29	ARG
5	C4	52	LEU
5	C4	53	TYR
5	C4	70	THR
5	C4	85	ASN
5	C4	95	ASP
5	C4	136	LEU
5	C4	142	MET
5	C4	168	THR
5	C4	170	TRP
5	C4	189	LEU
5	C4	200	PHE
5	C4	203	LYS
5	C4	209	ARG
5	C4	218	LEU
5	C4	235	LEU
5	C4	241	TYR
5	C4	271	THR
5	C4	273	VAL
5	C4	309	VAL
6	H4	35	MET
6	H4	41	ASP
6	H4	47[A]	LEU
6	H4	47[B]	LEU
6	H4	82	ARG
6	H4	87	LEU

Continued on next page...

Continued from previous page...

Mol	Chain	Res	Type
6	I4	35	MET
6	I4	39	MET
6	I4	45	ARG
6	J4	39	MET
6	J4	47[A]	LEU
6	J4	47[B]	LEU
6	N4	39	MET
6	N4	45	ARG
6	N4	71	THR

Sometimes sidechains can be flipped to improve hydrogen bonding and reduce clashes. All (138) such sidechains are listed below:

Mol	Chain	Res	Type
3	U	62	GLN
4	B	25	HIS
4	B	67	ASN
4	B	78	GLN
4	B	179	ASN
4	B	244	GLN
4	B	265	GLN
4	B	301	GLN
4	B	342	GLN
4	B	487	GLN
4	b	52	ASN
4	b	57	ASN
4	b	154	GLN
4	b	194	GLN
4	b	217	GLN
4	b	332	HIS
4	b	372	GLN
1	f1	114	ASN
2	W1	53	GLN
2	W1	58	GLN
2	w1	53	GLN
4	B1	39	ASN
4	B1	235	HIS
4	B1	265	GLN
4	B1	356	GLN
4	B1	407	GLN
4	b1	182	ASN
4	b1	194	GLN
4	b1	289	GLN

Continued on next page...

Continued from previous page...

Mol	Chain	Res	Type
4	b1	345	GLN
4	b1	356	GLN
4	b1	372	GLN
4	b1	376	ASN
4	b1	390	ASN
4	b1	407	GLN
4	b1	436	GLN
1	f2	114	ASN
2	W2	27	GLN
2	W2	53	GLN
2	W2	58	GLN
2	w2	53	GLN
4	B2	25	HIS
4	B2	78	GLN
4	B2	244	GLN
4	B2	289	GLN
4	B2	407	GLN
4	B2	492	GLN
4	b2	217	GLN
4	b2	372	GLN
2	W3	27	GLN
2	W3	58	GLN
4	B3	444	ASN
4	b3	57	ASN
4	b3	194	GLN
4	b3	299	ASN
4	b3	301	GLN
4	b3	342	GLN
2	w4	53	GLN
4	B4	34	GLN
4	B4	52	ASN
4	B4	75	GLN
4	B4	145	HIS
4	B4	179	ASN
4	B4	194	GLN
4	B4	266	ASN
4	B4	270	GLN
4	B4	462	GLN
4	B4	487	GLN
4	b4	25	HIS
4	b4	78	GLN
4	b4	90	HIS

Continued on next page...

Continued from previous page...

Mol	Chain	Res	Type
4	b4	168	GLN
4	b4	410	GLN
2	W5	53	GLN
4	B5	34	GLN
4	B5	66	ASN
4	B5	168	GLN
4	B5	235	HIS
4	b5	299	ASN
4	b5	301	GLN
4	b5	342	GLN
5	A0	43	GLN
5	A0	87	GLN
5	A0	115	ASN
5	A0	130	GLN
5	A0	160	ASN
5	G0	278	GLN
5	C0	15	GLN
5	C0	43	GLN
5	C0	115	ASN
5	C0	294	GLN
6	I0	68	GLN
5	A1	160	ASN
5	A1	161	ASN
5	A1	289	GLN
5	G1	114	GLN
5	G1	130	GLN
5	G1	339	GLN
5	C1	13	ASN
5	C1	43	GLN
5	C1	125	GLN
5	C1	160	ASN
6	H1	20	HIS
6	J1	13	GLN
6	N1	13	GLN
5	A2	82	HIS
5	A2	130	GLN
5	A2	164	GLN
5	A2	256	GLN
5	G2	43	GLN
5	G2	114	GLN
5	G2	130	GLN
5	G2	265	ASN

Continued on next page...

Continued from previous page...

Mol	Chain	Res	Type
5	G2	339	GLN
6	H2	13	GLN
5	A3	87	GLN
5	A3	339	GLN
5	G3	299	ASN
5	G3	322	GLN
5	C3	256	GLN
5	C3	278	GLN
6	H3	15	ASN
5	A4	43	GLN
5	A4	87	GLN
5	A4	164	GLN
5	A4	289	GLN
5	A4	294	GLN
5	G4	43	GLN
5	G4	125	GLN
5	G4	164	GLN
5	G4	294	GLN
5	G4	322	GLN
5	G4	339	GLN
5	C4	115	ASN
5	C4	307	ASN
5	C4	339	GLN
6	I4	9	HIS
6	J4	13	GLN

5.3.3 RNA [i](#)

There are no RNA molecules in this entry.

5.4 Non-standard residues in protein, DNA, RNA chains [i](#)

There are no non-standard protein/DNA/RNA residues in this entry.

5.5 Carbohydrates [i](#)

There are no oligosaccharides in this entry.

5.6 Ligand geometry [i](#)

There are no ligands in this entry.

5.7 Other polymers [i](#)

There are no such residues in this entry.

5.8 Polymer linkage issues [i](#)

There are no chain breaks in this entry.

6 Map visualisation [i](#)

This section contains visualisations of the EMDB entry EMD-38572. These allow visual inspection of the internal detail of the map and identification of artifacts.

Images derived from a raw map, generated by summing the deposited half-maps, are presented below the corresponding image components of the primary map to allow further visual inspection and comparison with those of the primary map.

6.1 Orthogonal projections [i](#)

6.1.1 Primary map

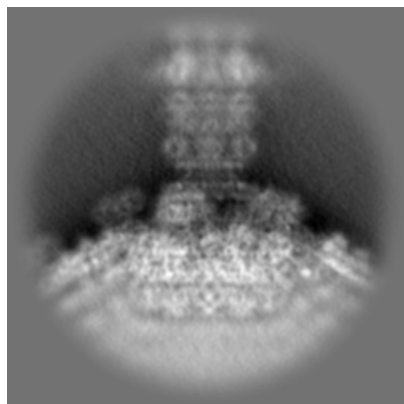

X

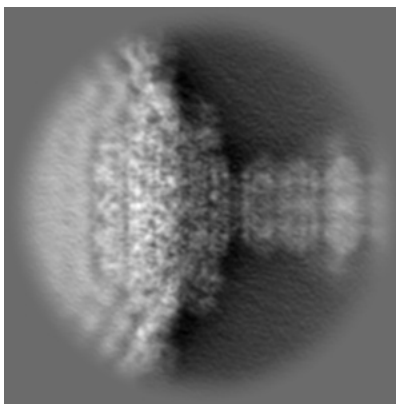

Y

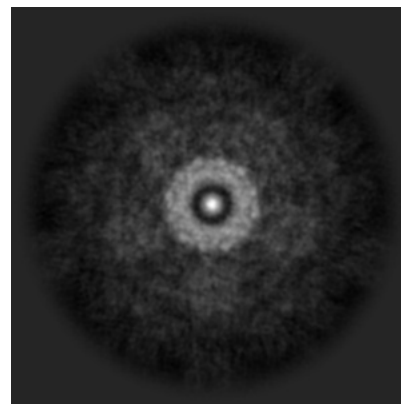

Z

6.1.2 Raw map

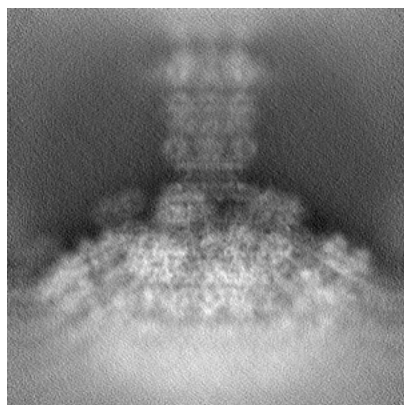

X

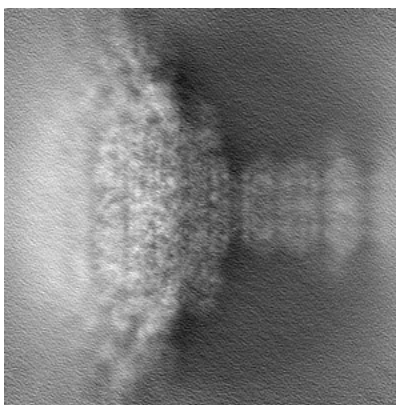

Y

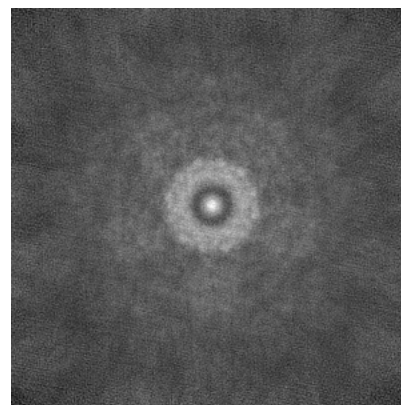

Z

The images above show the map projected in three orthogonal directions.

6.2 Central slices [i](#)

6.2.1 Primary map

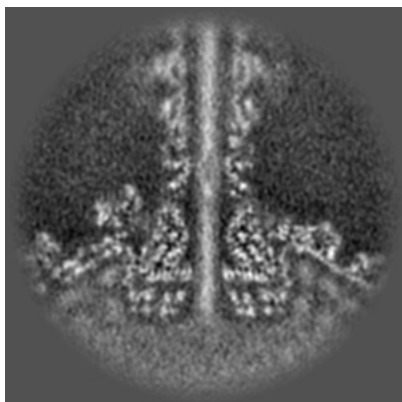

X Index: 160

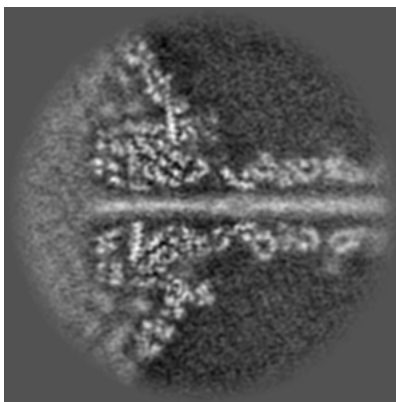

Y Index: 160

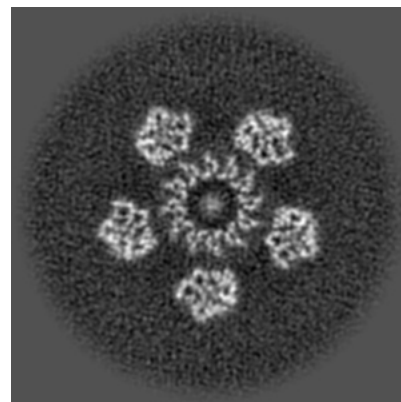

Z Index: 160

6.2.2 Raw map

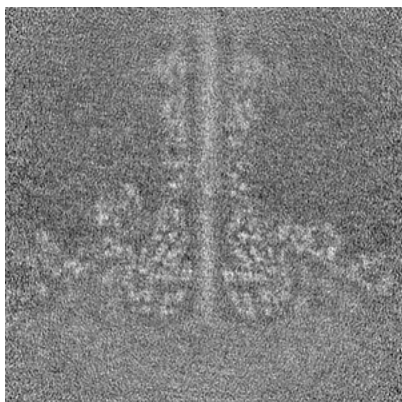

X Index: 160

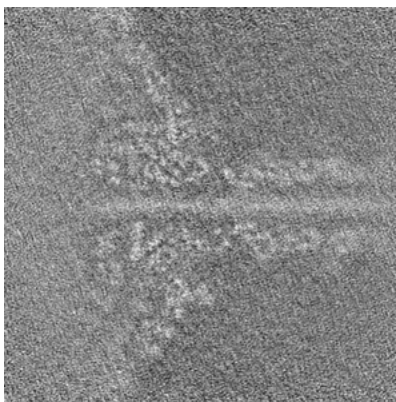

Y Index: 160

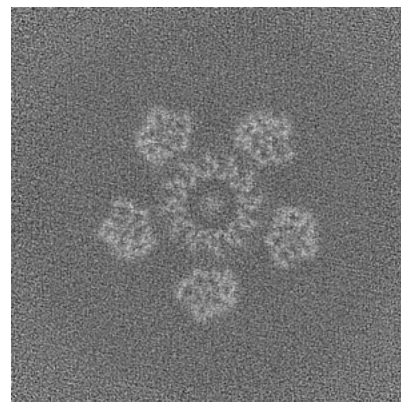

Z Index: 160

The images above show central slices of the map in three orthogonal directions.

6.3 Largest variance slices [i](#)

6.3.1 Primary map

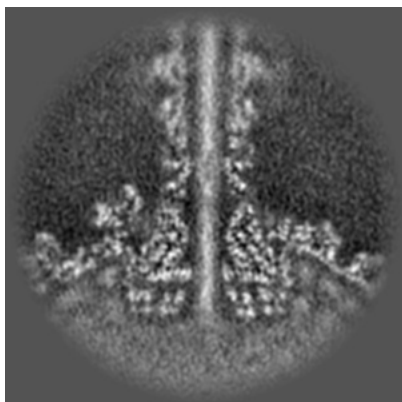

X Index: 161

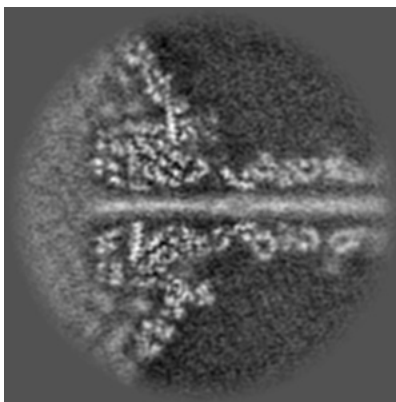

Y Index: 160

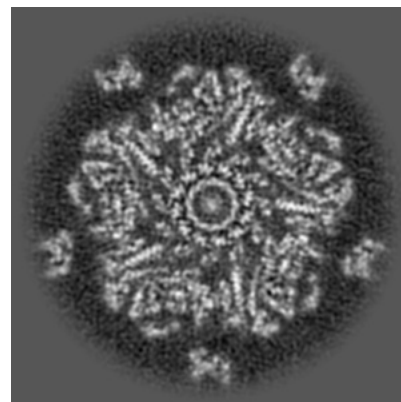

Z Index: 133

6.3.2 Raw map

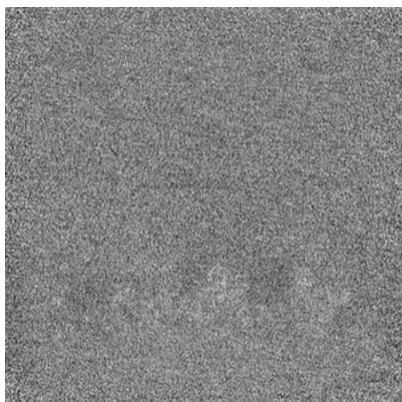

X Index: 0

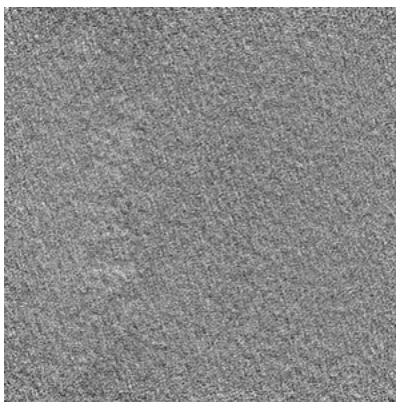

Y Index: 0

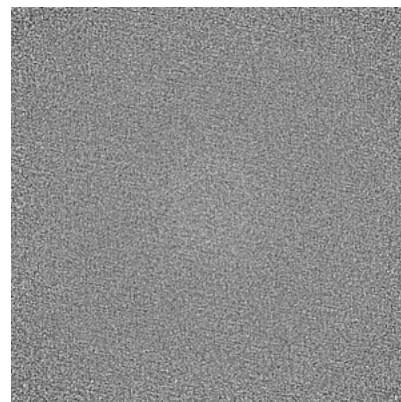

Z Index: 0

The images above show the largest variance slices of the map in three orthogonal directions.

6.4 Orthogonal standard-deviation projections (False-color) [i](#)

6.4.1 Primary map

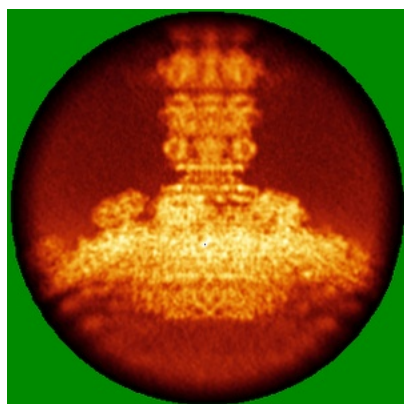

X

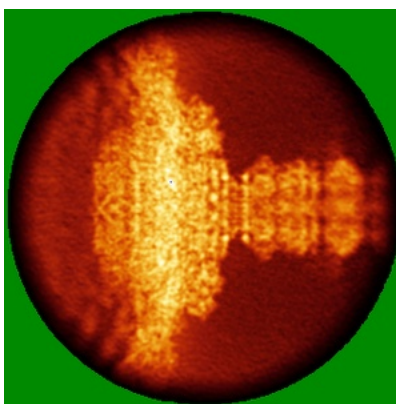

Y

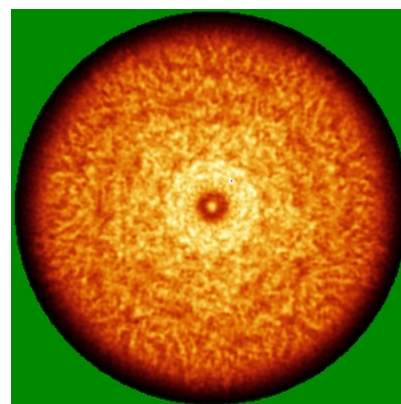

Z

6.4.2 Raw map

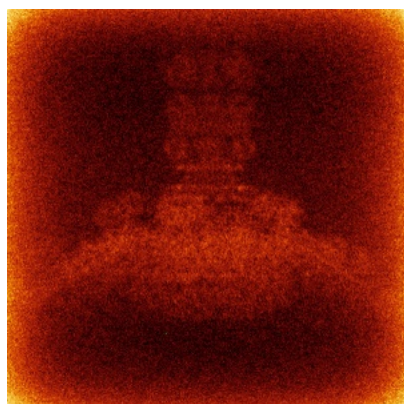

X

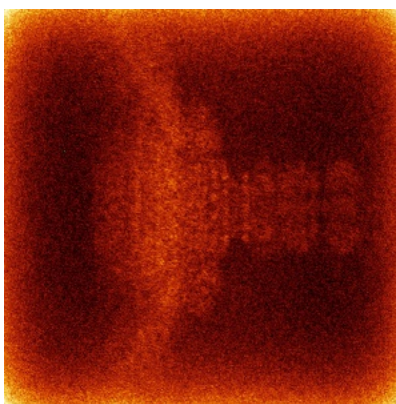

Y

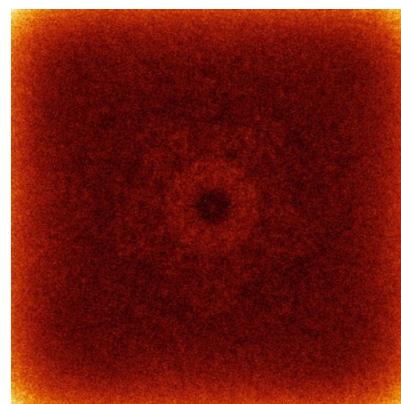

Z

The images above show the map standard deviation projections with false color in three orthogonal directions. Minimum values are shown in green, max in blue, and dark to light orange shades represent small to large values respectively.

6.5 Orthogonal surface views [i](#)

6.5.1 Primary map

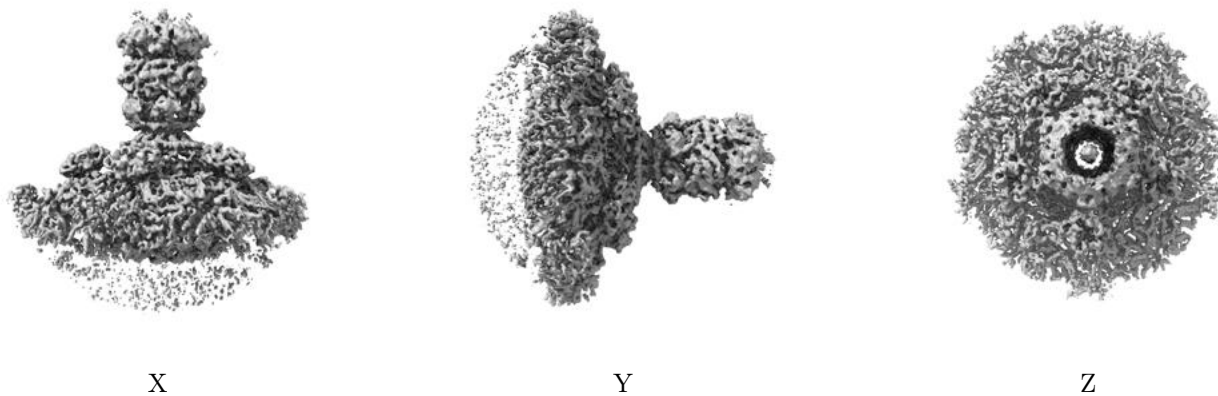

The images above show the 3D surface view of the map at the recommended contour level 0.3. These images, in conjunction with the slice images, may facilitate assessment of whether an appropriate contour level has been provided.

6.5.2 Raw map

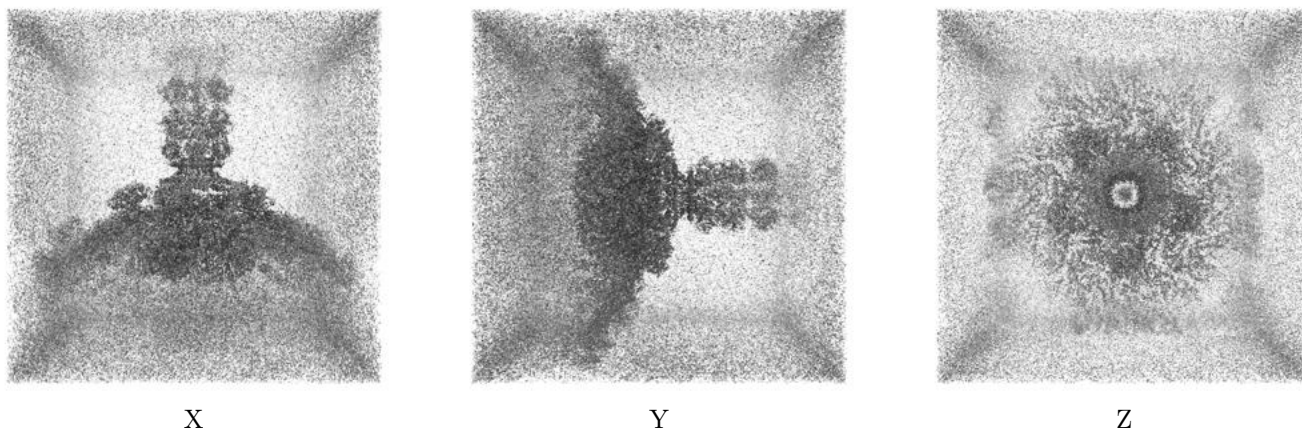

These images show the 3D surface of the raw map. The raw map's contour level was selected so that its surface encloses the same volume as the primary map does at its recommended contour level.

6.6 Mask visualisation [i](#)

This section was not generated. No masks/segmentation were deposited.

7 Map analysis [i](#)

This section contains the results of statistical analysis of the map.

7.1 Map-value distribution [i](#)

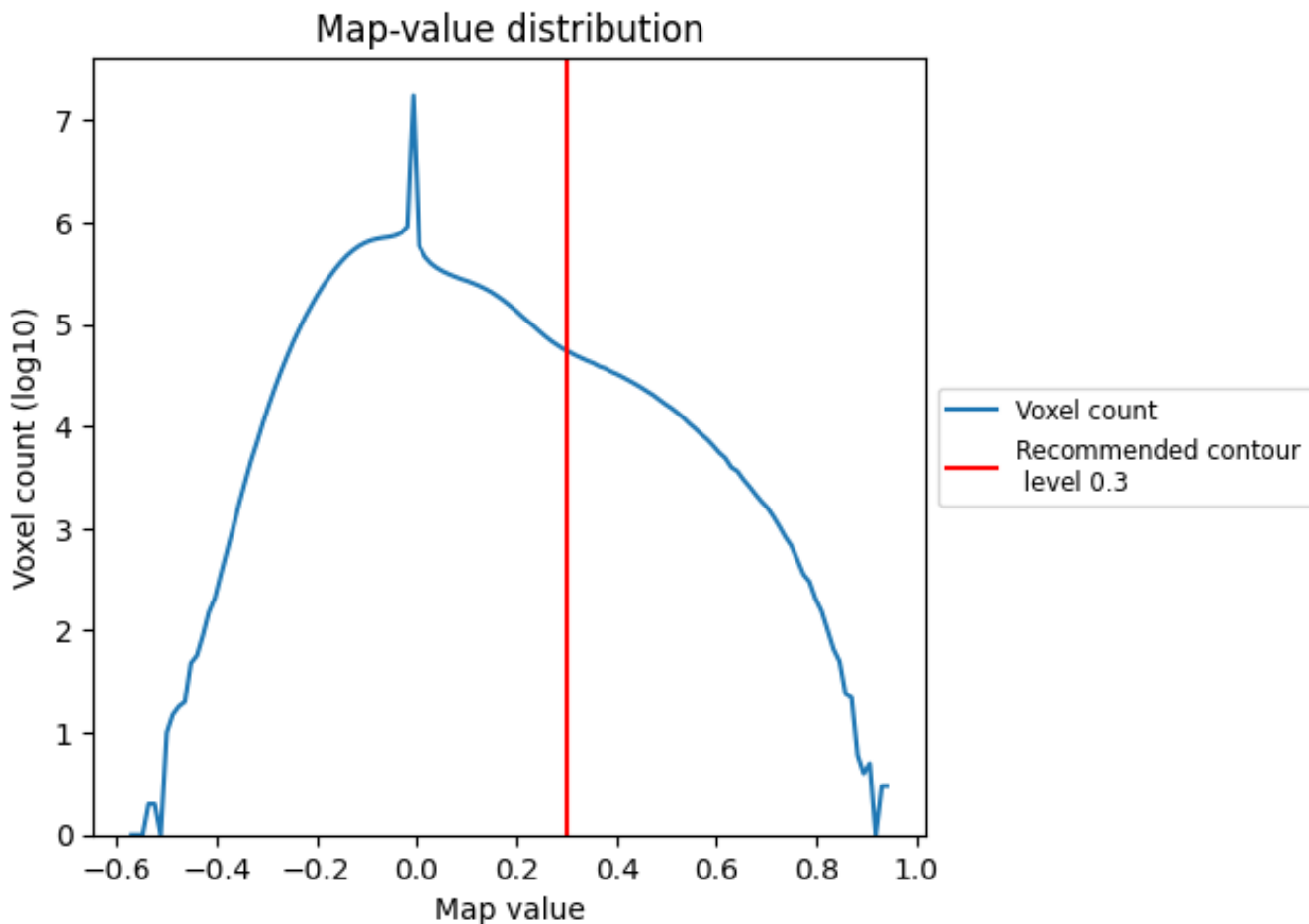

The map-value distribution is plotted in 128 intervals along the x-axis. The y-axis is logarithmic. A spike in this graph at zero usually indicates that the volume has been masked.

7.2 Volume estimate [i](#)

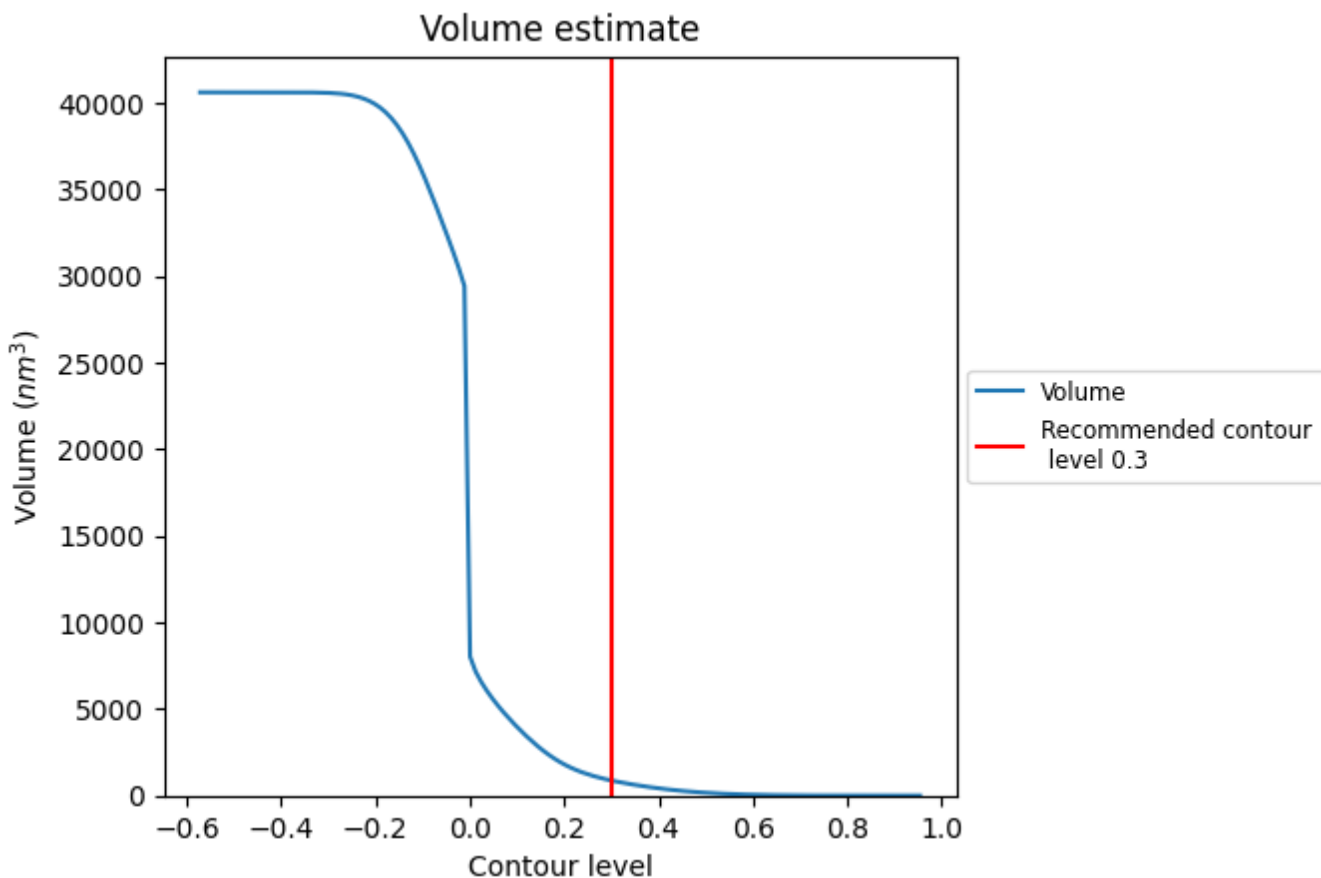

The volume at the recommended contour level is 871 nm³; this corresponds to an approximate mass of 787 kDa.

The volume estimate graph shows how the enclosed volume varies with the contour level. The recommended contour level is shown as a vertical line and the intersection between the line and the curve gives the volume of the enclosed surface at the given level.

7.3 Rotationally averaged power spectrum i

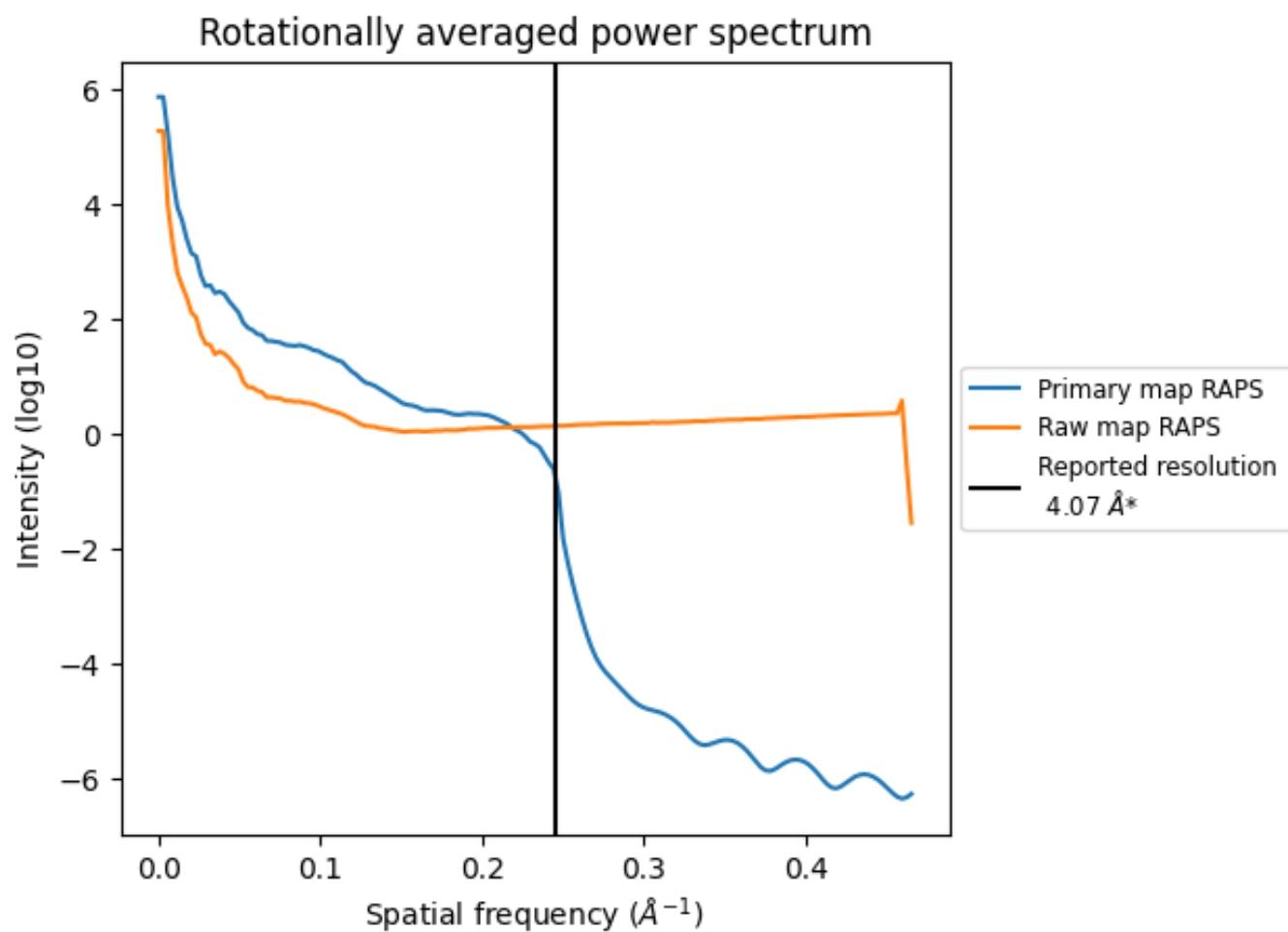

*Reported resolution corresponds to spatial frequency of 0.246 Å⁻¹

8 Fourier-Shell correlation [i](#)

Fourier-Shell Correlation (FSC) is the most commonly used method to estimate the resolution of single-particle and subtomogram-averaged maps. The shape of the curve depends on the imposed symmetry, mask and whether or not the two 3D reconstructions used were processed from a common reference. The reported resolution is shown as a black line. A curve is displayed for the half-bit criterion in addition to lines showing the 0.143 gold standard cut-off and 0.5 cut-off.

8.1 FSC [i](#)

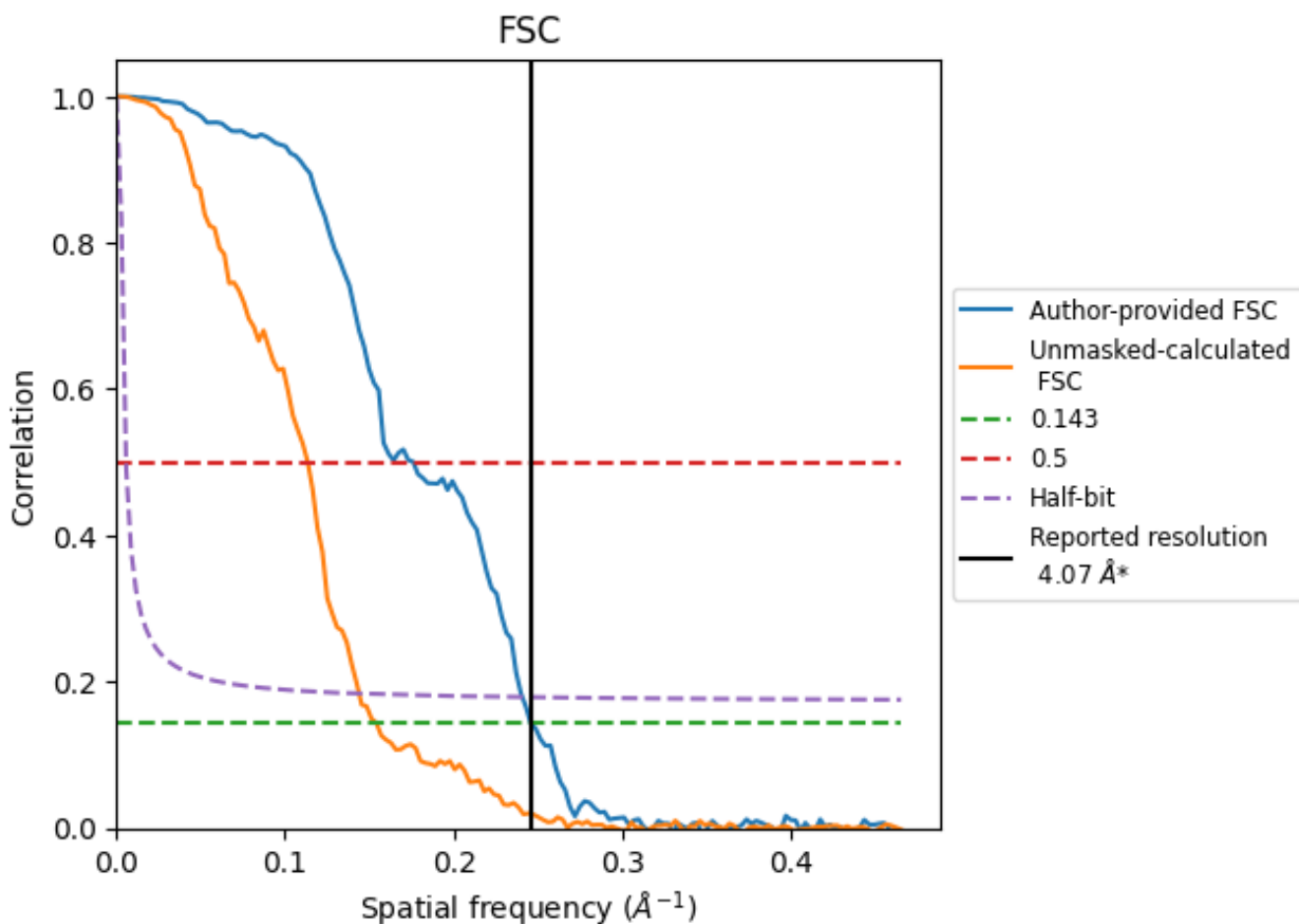

*Reported resolution corresponds to spatial frequency of 0.246 Å⁻¹

8.2 Resolution estimates [i](#)

Resolution estimate (Å)	Estimation criterion (FSC cut-off)		
	0.143	0.5	Half-bit
Reported by author	4.07	-	-
Author-provided FSC curve	4.07	5.68	4.15
Unmasked-calculated*	6.48	8.81	6.94

*Resolution estimate based on FSC curve calculated by comparison of deposited half-maps. The value from deposited half-maps intersecting FSC 0.143 CUT-OFF 6.48 differs from the reported value 4.07 by more than 10 %

9 Map-model fit [i](#)

This section contains information regarding the fit between EMDB map EMD-38572 and PDB model 8XQB. Per-residue inclusion information can be found in section 3 on page 10.

9.1 Map-model overlay [i](#)

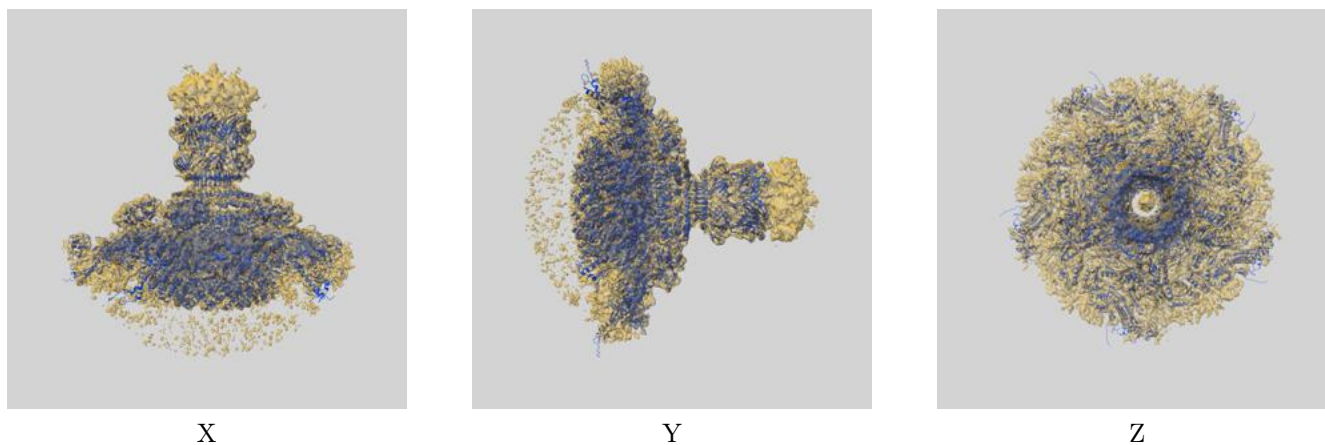

The images above show the 3D surface view of the map at the recommended contour level 0.3 at 50% transparency in yellow overlaid with a ribbon representation of the model coloured in blue. These images allow for the visual assessment of the quality of fit between the atomic model and the map.

9.2 Q-score mapped to coordinate model [\(i\)](#)

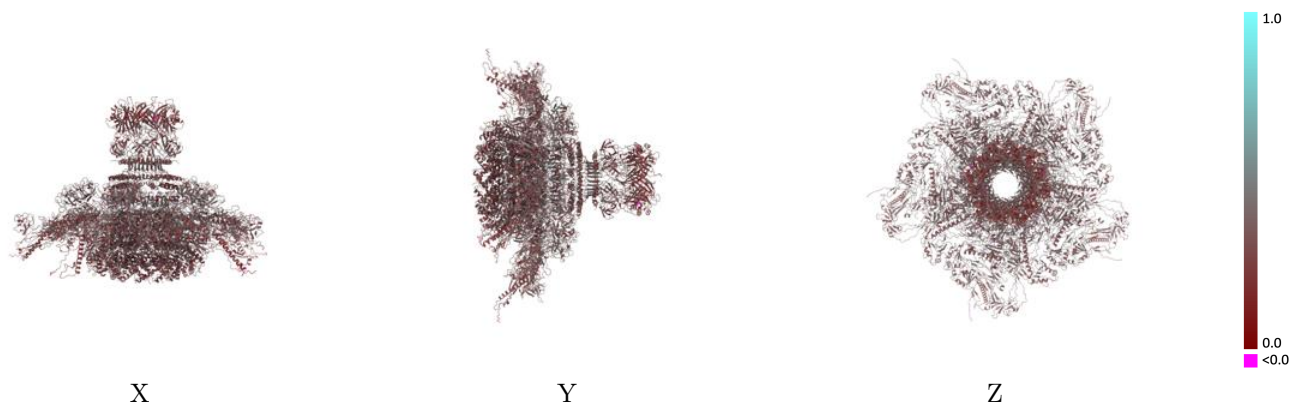

The images above show the model with each residue coloured according to its Q-score. This shows their resolvability in the map with higher Q-score values reflecting better resolvability. Please note: Q-score is calculating the resolvability of atoms, and thus high values are only expected at resolutions at which atoms can be resolved. Low Q-score values may therefore be expected for many entries.

9.3 Atom inclusion mapped to coordinate model [\(i\)](#)

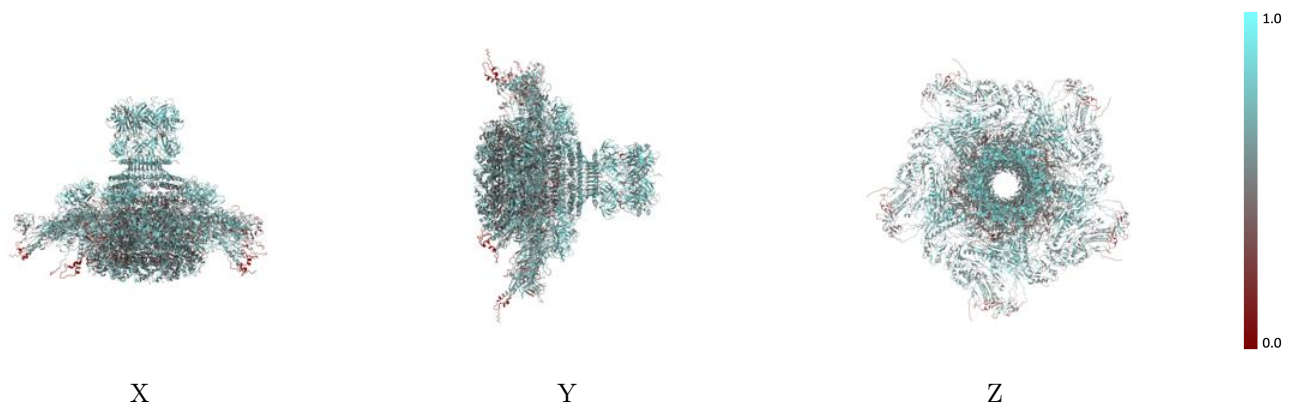

The images above show the model with each residue coloured according to its atom inclusion. This shows to what extent they are inside the map at the recommended contour level (0.3).

9.4 Atom inclusion [i](#)

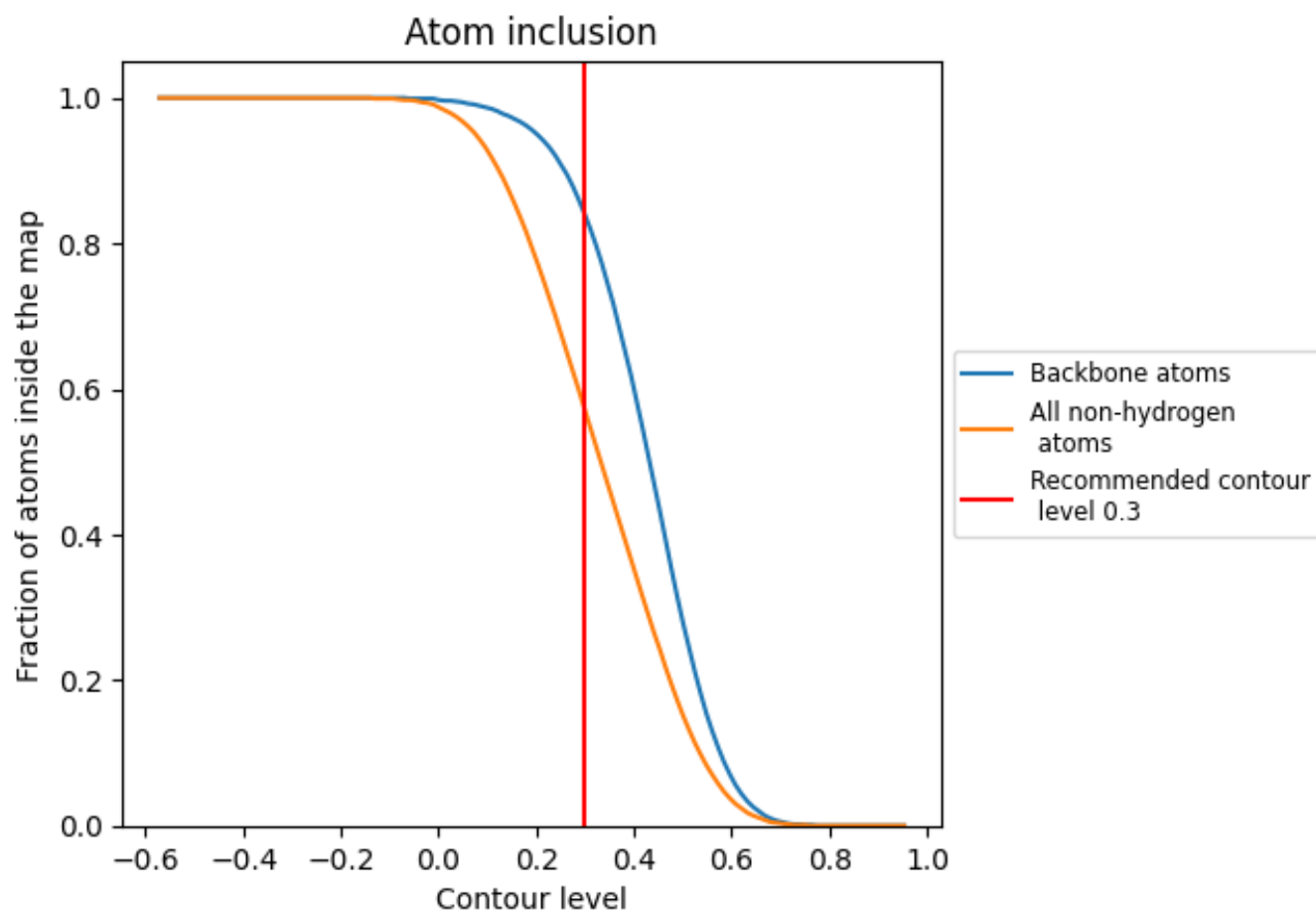

At the recommended contour level, 84% of all backbone atoms, 57% of all non-hydrogen atoms, are inside the map.

9.5 Map-model fit summary











































































The table lists the average atom inclusion at the recommended contour level (0.3) and Q-score for the entire model and for each chain.

Chain	Atom inclusion	Q-score
All	0.5710	0.3340
A0	0.4890	0.3180
A1	0.5170	0.3240
A2	0.5190	0.3140
A3	0.5000	0.3110
A4	0.4870	0.3120
B	0.5400	0.3420
B1	0.5490	0.3400
B2	0.5580	0.3350
B3	0.5490	0.3310
B4	0.5510	0.3400
B5	0.5460	0.3360
C0	0.5720	0.3330
C1	0.5780	0.3430
C2	0.5700	0.3380
C3	0.5780	0.3340
C4	0.5700	0.3310
G0	0.5670	0.3490
G1	0.5920	0.3470
G2	0.5790	0.3420
G3	0.5920	0.3450
G4	0.5720	0.3350
H0	0.6890	0.3790
H1	0.7080	0.3740
H2	0.7070	0.3720
H3	0.7120	0.3690
H4	0.6930	0.3700
I0	0.6010	0.3520
I1	0.5850	0.3430
I2	0.5990	0.3430
I3	0.5940	0.3220
I4	0.5670	0.3440
J0	0.6990	0.3780
J1	0.6620	0.3710
J2	0.6750	0.3590



Continued on next page...

Continued from previous page...

Chain	Atom inclusion	Q-score
J3	 0.6980	 0.3760
J4	 0.7090	 0.3650
N0	 0.4470	 0.3430
N1	 0.4750	 0.3430
N2	 0.4440	 0.3320
N3	 0.4130	 0.3360
N4	 0.4090	 0.3350
U	 0.6650	 0.2680
U1	 0.6760	 0.2690
U2	 0.6650	 0.2630
U3	 0.6480	 0.2590
U4	 0.6450	 0.2730
U5	 0.6480	 0.2650
W	 0.6150	 0.3470
W1	 0.5990	 0.3540
W2	 0.6150	 0.3390
W3	 0.6130	 0.3600
W4	 0.5790	 0.3620
W5	 0.6050	 0.3500
b	 0.5810	 0.3370
b1	 0.5330	 0.3370
b2	 0.5250	 0.3350
b3	 0.5180	 0.3360
b4	 0.5310	 0.3370
b5	 0.5670	 0.3410
f	 0.7010	 0.3390
f1	 0.6820	 0.3200
f2	 0.6880	 0.3210
f3	 0.6920	 0.3230
f4	 0.7000	 0.3340
f5	 0.6840	 0.3330
w	 0.5890	 0.3420
w1	 0.5770	 0.3320
w2	 0.5850	 0.3360
w3	 0.5930	 0.3530
w4	 0.5910	 0.3470
w5	 0.6090	 0.3510