



## Full wwPDB EM Validation Report ⓘ

Apr 22, 2024 – 10:35 AM EDT

PDB ID : 8U81  
EMDB ID : EMD-41996  
Title : KCTD5/Cullin3/Gbeta1gamma2 Complex: State A From Composite RE-  
LION Multi-body Refinement Map  
Authors : Kuntz, D.A.; Nguyen, D.M.; Narayanan, N.; Prive, G.G.  
Deposited on : 2023-09-15  
Resolution : 3.82 Å (reported)  
Based on initial models : 3DRX, 6VMS, 4EOZ

This is a Full wwPDB EM Validation Report for a publicly released PDB entry.

We welcome your comments at [validation@mail.wwpdb.org](mailto:validation@mail.wwpdb.org)

A user guide is available at

<https://www.wwpdb.org/validation/2017/EMValidationReportHelp>

with specific help available everywhere you see the ⓘ symbol.

The types of validation reports are described at

<http://www.wwpdb.org/validation/2017/FAQs#types>.

---

The following versions of software and data (see [references ⓘ](#)) were used in the production of this report:

EMDB validation analysis : 0.0.1.dev92  
MolProbity : 4.02b-467  
Percentile statistics : 20191225.v01 (using entries in the PDB archive December 25th 2019)  
MapQ : 1.9.13  
Ideal geometry (proteins) : Engh & Huber (2001)  
Ideal geometry (DNA, RNA) : Parkinson et al. (1996)  
Validation Pipeline (wwPDB-VP) : 2.36.2

# 1 Overall quality at a glance i

The following experimental techniques were used to determine the structure:

*ELECTRON MICROSCOPY*

The reported resolution of this entry is 3.82 Å.

Percentile scores (ranging between 0-100) for global validation metrics of the entry are shown in the following graphic. The table shows the number of entries on which the scores are based.

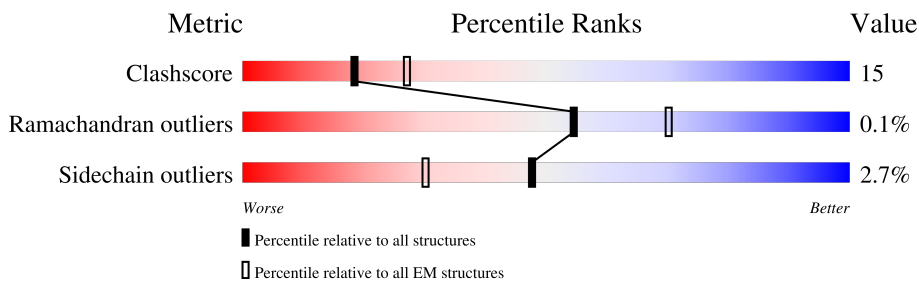

Metric	Whole archive (#Entries)	EM structures (#Entries)
Clashscore	158937	4297
Ramachandran outliers	154571	4023
Sidechain outliers	154315	3826

The table below summarises the geometric issues observed across the polymeric chains and their fit to the map. The red, orange, yellow and green segments of the bar indicate the fraction of residues that contain outliers for  $\geq 3$ , 2, 1 and 0 types of geometric quality criteria respectively. A grey segment represents the fraction of residues that are not modelled. The numeric value for each fraction is indicated below the corresponding segment, with a dot representing fractions  $\leq 5\%$ . The upper red bar (where present) indicates the fraction of residues that have poor fit to the EM map (all-atom inclusion  $< 40\%$ ). The numeric value is given above the bar.

Mol	Chain	Length	Quality of chain
1	K1	233	
1	K2	233	
1	K3	233	
1	K4	233	
1	K5	233	
2	C1	381	
2	C2	381	
2	C3	381	

Continued on next page...

Continued from previous page...

Mol	Chain	Length	Quality of chain
2	C4	381	<p>7% 62% 31% 6%</p>
2	C5	381	<p>61% 31% 6%</p>
3	B1	340	<p>67% 32%</p>
3	B2	340	<p>64% 34% 6%</p>
3	B3	340	<p>63% 35% 6%</p>
3	B4	340	<p>67% 32% 6%</p>
3	B5	340	<p>65% 33% 6%</p>
4	G1	71	<p>52% 35% 11%</p>
4	G2	71	<p>51% 37% 11%</p>
4	G3	71	<p>62% 25% 11%</p>
4	G4	71	<p>59% 28% 11%</p>
4	G5	71	<p>63% 21% 11%</p>

## 2 Entry composition [i](#)

There are 4 unique types of molecules in this entry. The entry contains 37890 atoms, of which 0 are hydrogens and 0 are deuteriums.

In the tables below, the AltConf column contains the number of residues with at least one atom in alternate conformation and the Trace column contains the number of residues modelled with at most 2 atoms.

- Molecule 1 is a protein called BTB/POZ domain-containing protein KCTD5.

Mol	Chain	Residues	Atoms					AltConf	Trace
			Total	C	N	O	S		
1	K1	194	1559	979	265	309	6	0	0
1	K2	194	1559	979	265	309	6	0	0
1	K3	194	1559	979	265	309	6	0	0
1	K4	194	1559	979	265	309	6	0	0
1	K5	194	1559	979	265	309	6	0	0

- Molecule 2 is a protein called Cullin-3.

Mol	Chain	Residues	Atoms					AltConf	Trace
			Total	C	N	O	S		
2	C1	358	2932	1844	509	555	24	0	0
2	C2	358	2932	1844	509	555	24	0	0
2	C3	358	2932	1844	509	555	24	0	0
2	C4	358	2932	1844	509	555	24	0	0
2	C5	358	2932	1844	509	555	24	0	0

- Molecule 3 is a protein called Guanine nucleotide-binding protein G(I)/G(S)/G(T) subunit beta-1.

Mol	Chain	Residues	Atoms					AltConf	Trace
			Total	C	N	O	S		
3	B1	339	2607	1607	468	511	21	0	0
3	B2	339	2607	1607	468	511	21	0	0

*Continued on next page...*

Continued from previous page...

Mol	Chain	Residues	Atoms					AltConf	Trace
3	B3	339	Total	C	N	O	S	0	0
			2607	1607	468	511	21		
3	B4	339	Total	C	N	O	S	0	0
			2607	1607	468	511	21		
3	B5	339	Total	C	N	O	S	0	0
			2607	1607	468	511	21		

- Molecule 4 is a protein called Guanine nucleotide-binding protein G(I)/G(S)/G(O) subunit gamma-2.

Mol	Chain	Residues	Atoms					AltConf	Trace
4	G1	63	Total	C	N	O	S	0	0
			480	297	85	94	4		
4	G2	63	Total	C	N	O	S	0	0
			480	297	85	94	4		
4	G3	63	Total	C	N	O	S	0	0
			480	297	85	94	4		
4	G4	63	Total	C	N	O	S	0	0
			480	297	85	94	4		
4	G5	63	Total	C	N	O	S	0	0
			480	297	85	94	4		

There are 5 discrepancies between the modelled and reference sequences:

Chain	Residue	Modelled	Actual	Comment	Reference
G1	68	SER	CYS	engineered mutation	UNP P59768
G2	68	SER	CYS	engineered mutation	UNP P59768
G3	68	SER	CYS	engineered mutation	UNP P59768
G4	68	SER	CYS	engineered mutation	UNP P59768
G5	68	SER	CYS	engineered mutation	UNP P59768

### 3 Residue-property plots [i](#)

These plots are drawn for all protein, RNA, DNA and oligosaccharide chains in the entry. The first graphic for a chain summarises the proportions of the various outlier classes displayed in the second graphic. The second graphic shows the sequence view annotated by issues in geometry and atom inclusion in map density. Residues are color-coded according to the number of geometric quality criteria for which they contain at least one outlier: green = 0, yellow = 1, orange = 2 and red = 3 or more. A red diamond above a residue indicates a poor fit to the EM map for this residue (all-atom inclusion < 40%). Stretches of 2 or more consecutive residues without any outlier are shown as a green connector. Residues present in the sample, but not in the model, are shown in grey.

- Molecule 1: BTB/POZ domain-containing protein KCTD5

Chain K1: 

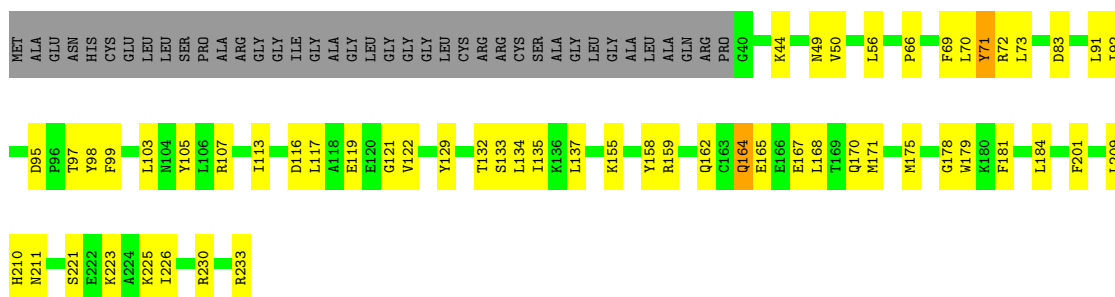

- Molecule 1: BTB/POZ domain-containing protein KCTD5

Chain K2: 

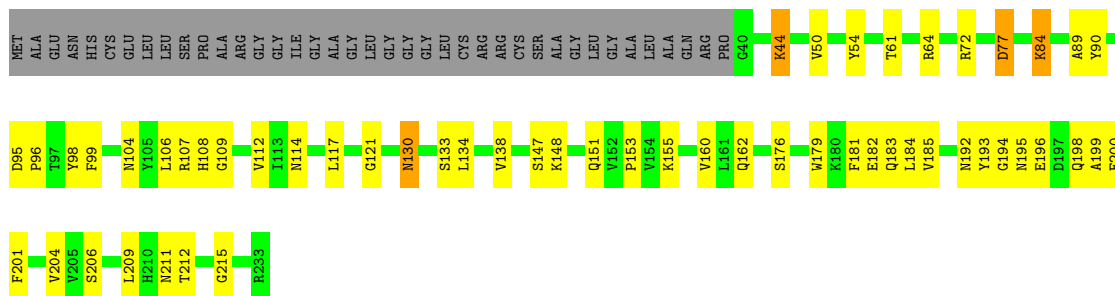

- Molecule 1: BTB/POZ domain-containing protein KCTD5

Chain K3: 

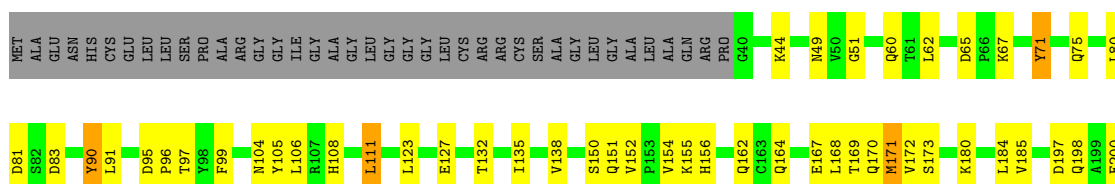

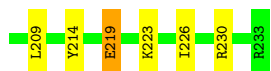

• Molecule 1: BTB/POZ domain-containing protein KCTD5

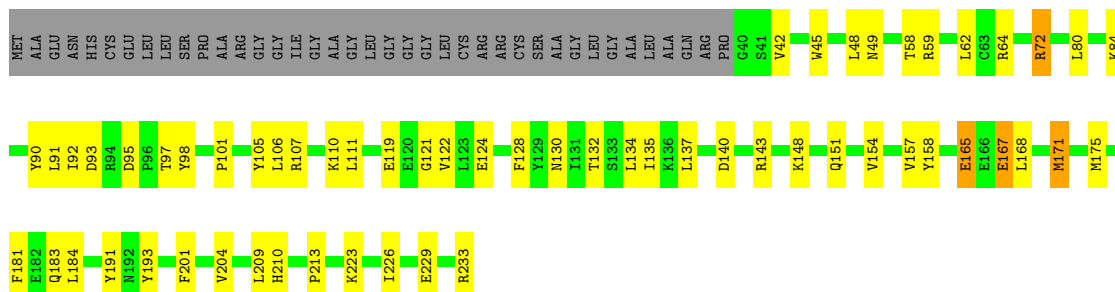

• Molecule 1: BTB/POZ domain-containing protein KCTD5

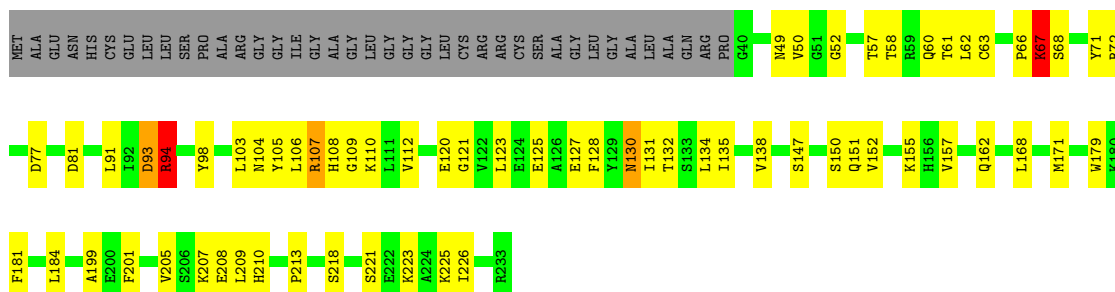

• Molecule 2: Cullin-3

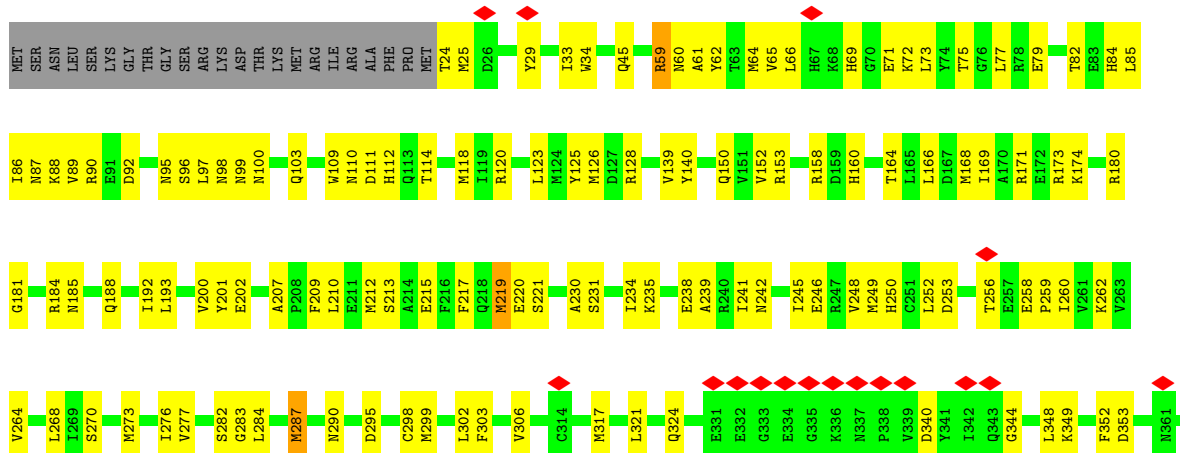

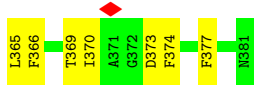

• Molecule 2: Cullin-3

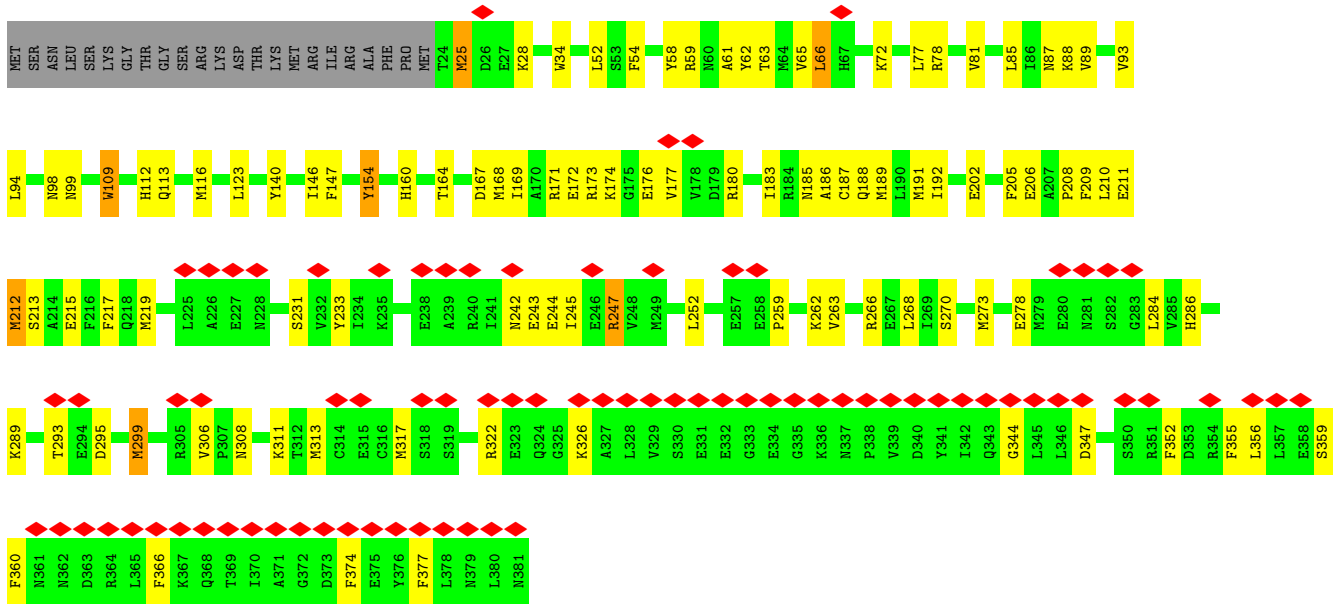

• Molecule 2: Cullin-3

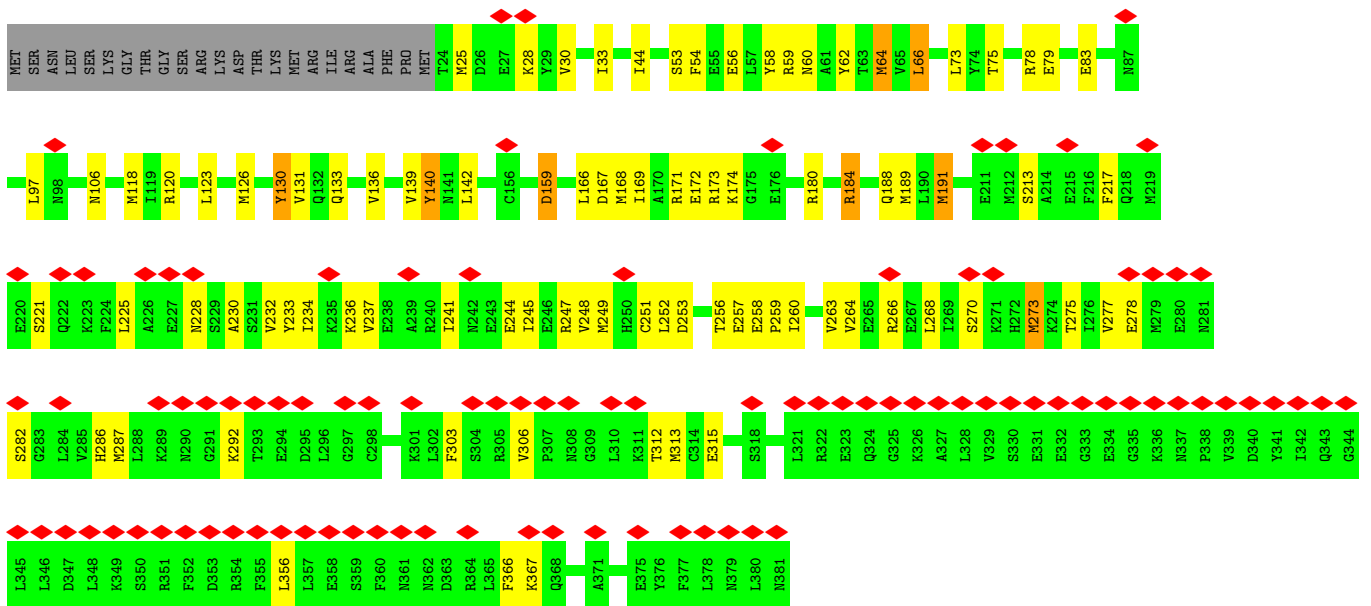

• Molecule 2: Cullin-3





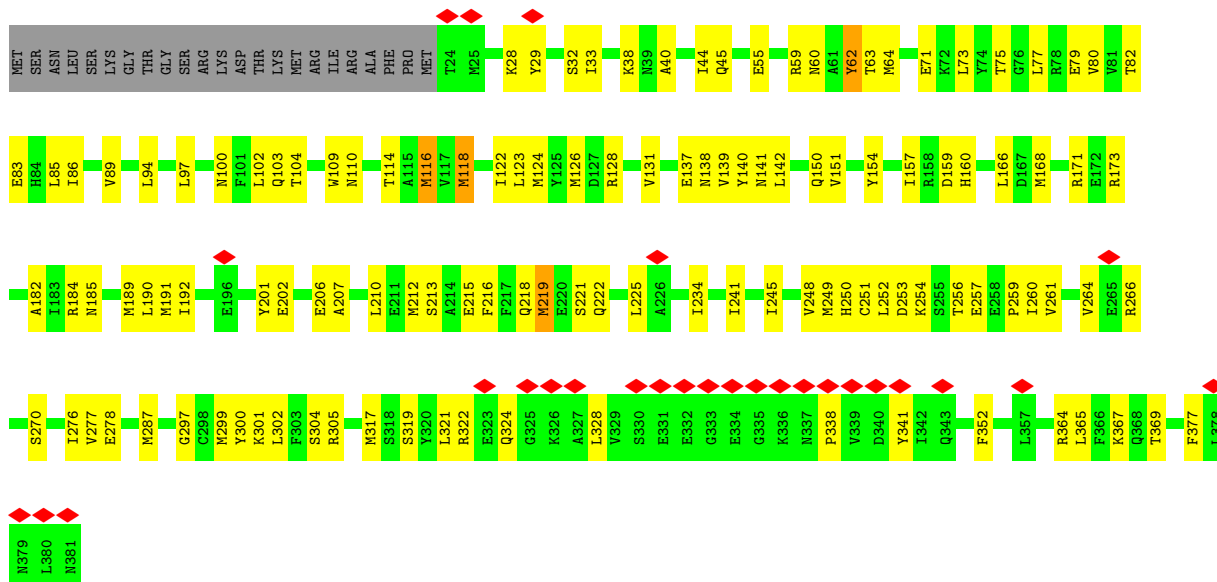

Molecule 2: Cullin-3

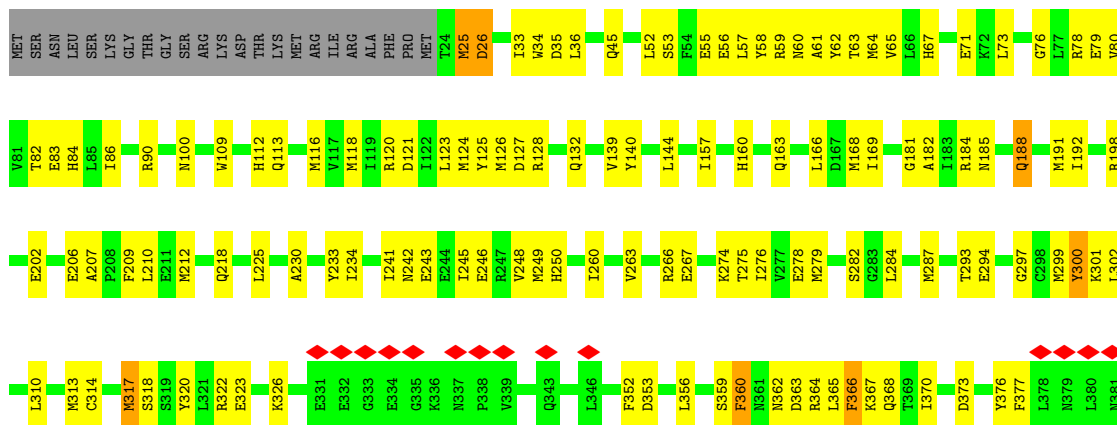

Molecule 3: Guanine nucleotide-binding protein G(I)/G(S)/G(T) subunit beta-1

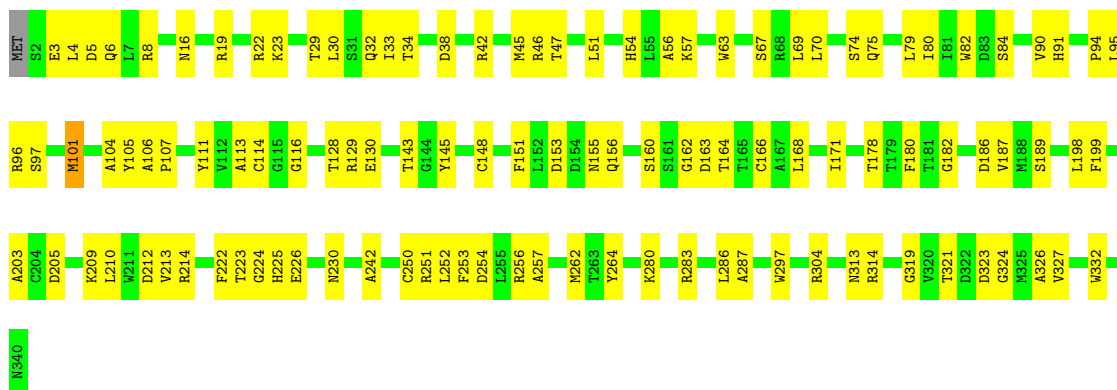

- Molecule 3: Guanine nucleotide-binding protein G(I)/G(S)/G(T) subunit beta-1

Chain B2:  64% 34%

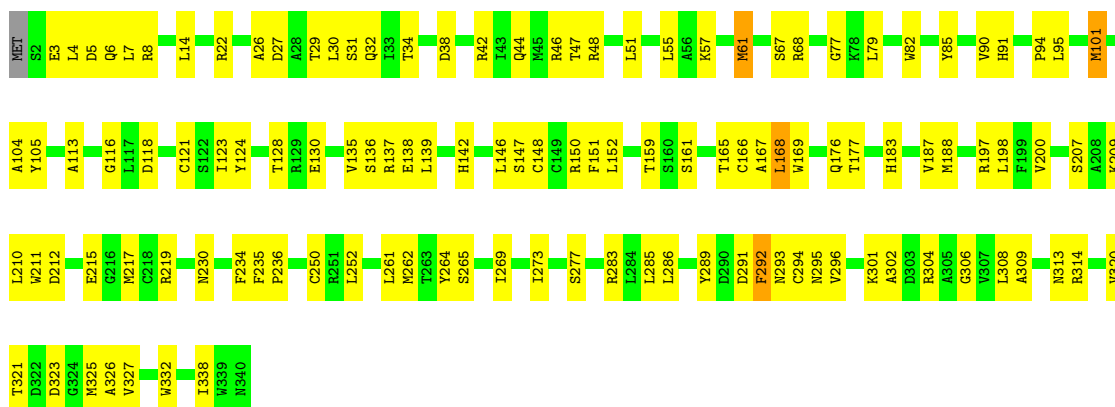

- Molecule 3: Guanine nucleotide-binding protein G(I)/G(S)/G(T) subunit beta-1

Chain B3:  63% 35%

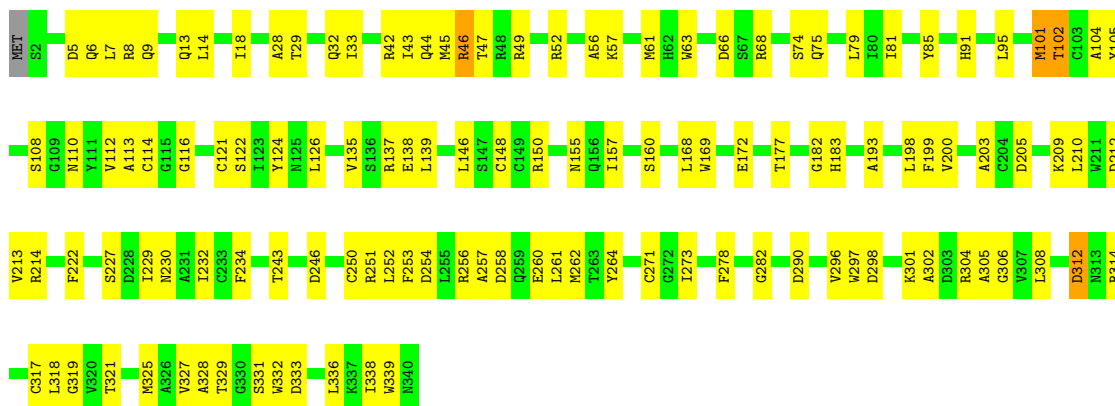

- Molecule 3: Guanine nucleotide-binding protein G(I)/G(S)/G(T) subunit beta-1

Chain B4:  67% 32%

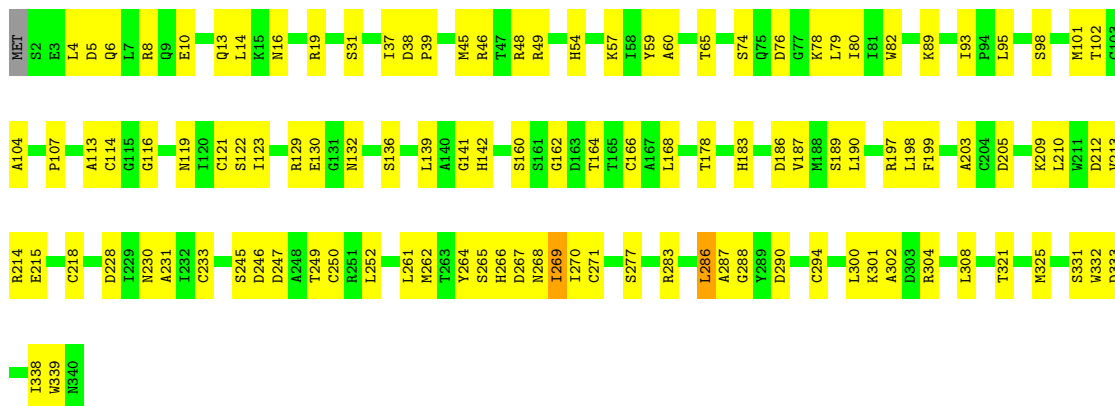

- Molecule 3: Guanine nucleotide-binding protein G(I)/G(S)/G(T) subunit beta-1

Chain B5:  65% 33%

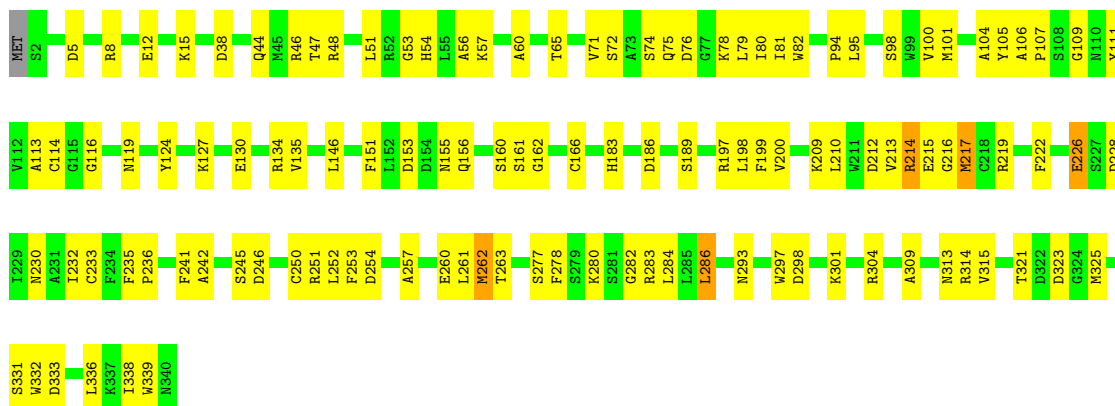

- Molecule 4: Guanine nucleotide-binding protein G(I)/G(S)/G(O) subunit gamma-2

Chain G1:  52% 35% 11%



- Molecule 4: Guanine nucleotide-binding protein G(I)/G(S)/G(O) subunit gamma-2

Chain G2:  51% 37% 11%



- Molecule 4: Guanine nucleotide-binding protein G(I)/G(S)/G(O) subunit gamma-2

Chain G3:  62% 25% 11%

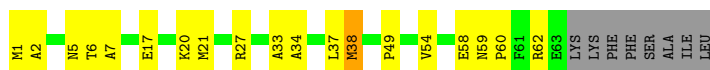

- Molecule 4: Guanine nucleotide-binding protein G(I)/G(S)/G(O) subunit gamma-2

Chain G4:  59% 28% 11%



- Molecule 4: Guanine nucleotide-binding protein G(I)/G(S)/G(O) subunit gamma-2

Chain G5:  63% 21% 11%



## 4 Experimental information

Property	Value	Source
EM reconstruction method	SINGLE PARTICLE	Depositor
Imposed symmetry	POINT, C1	Depositor
Number of particles used	48895	Depositor
Resolution determination method	FSC 0.143 CUT-OFF	Depositor
CTF correction method	PHASE FLIPPING AND AMPLITUDE CORRECTION	Depositor
Microscope	FEI TITAN KRIOS	Depositor
Voltage (kV)	300	Depositor
Electron dose ( $e^-/\text{\AA}^2$ )	49.35	Depositor
Minimum defocus (nm)	250	Depositor
Maximum defocus (nm)	1500	Depositor
Magnification	Not provided	
Image detector	FEI FALCON IV (4k x 4k)	Depositor
Maximum map value	25.614	Depositor
Minimum map value	-6.558	Depositor
Average map value	-0.007	Depositor
Map value standard deviation	1.074	Depositor
Recommended contour level	1.6	Depositor
Map size (Å)	333.72, 333.72, 333.72	wwPDB
Map dimensions	324, 324, 324	wwPDB
Map angles (°)	90.0, 90.0, 90.0	wwPDB
Pixel spacing (Å)	1.03, 1.03, 1.03	Depositor

## 5 Model quality [i](#)

### 5.1 Standard geometry [i](#)

The Z score for a bond length (or angle) is the number of standard deviations the observed value is removed from the expected value. A bond length (or angle) with  $|Z| > 5$  is considered an outlier worth inspection. RMSZ is the root-mean-square of all Z scores of the bond lengths (or angles).

Mol	Chain	Bond lengths		Bond angles	
		RMSZ	# Z  >5	RMSZ	# Z  >5
1	K1	0.28	0/1588	0.54	0/2144
1	K2	0.30	0/1588	0.55	0/2144
1	K3	0.29	0/1588	0.53	0/2144
1	K4	0.29	0/1588	0.53	0/2144
1	K5	0.30	0/1588	0.56	0/2144
2	C1	0.26	0/2976	0.54	0/3996
2	C2	0.27	0/2976	0.55	1/3996 (0.0%)
2	C3	0.26	0/2976	0.53	0/3996
2	C4	0.28	0/2976	0.56	0/3996
2	C5	0.28	0/2976	0.59	0/3996
3	B1	0.30	0/2654	0.56	0/3597
3	B2	0.29	0/2654	0.56	0/3597
3	B3	0.30	0/2654	0.56	1/3597 (0.0%)
3	B4	0.29	0/2654	0.56	0/3597
3	B5	0.29	0/2654	0.57	0/3597
4	G1	0.27	0/486	0.53	0/656
4	G2	0.27	0/486	0.61	0/656
4	G3	0.28	0/486	0.62	1/656 (0.2%)
4	G4	0.26	0/486	0.53	0/656
4	G5	0.27	0/486	0.58	0/656
All	All	0.28	0/38520	0.55	3/51965 (0.0%)

Chiral center outliers are detected by calculating the chiral volume of a chiral center and verifying if the center is modelled as a planar moiety or with the opposite hand. A planarity outlier is detected by checking planarity of atoms in a peptide group, atoms in a mainchain group or atoms of a sidechain that are expected to be planar.

Mol	Chain	#Chirality outliers	#Planarity outliers
1	K4	0	1
1	K5	0	1
All	All	0	2

There are no bond length outliers.

All (3) bond angle outliers are listed below:

Mol	Chain	Res	Type	Atoms	Z	Observed(°)	Ideal(°)
4	G3	38	MET	CA-CB-CG	5.43	122.53	113.30
3	B3	312	ASP	CB-CG-OD2	5.36	123.12	118.30
2	C2	66	LEU	CA-CB-CG	5.09	127.02	115.30

There are no chirality outliers.

All (2) planarity outliers are listed below:

Mol	Chain	Res	Type	Group
1	K4	72	ARG	Sidechain
1	K5	94	ARG	Sidechain

## 5.2 Too-close contacts [i](#)

In the following table, the Non-H and H(model) columns list the number of non-hydrogen atoms and hydrogen atoms in the chain respectively. The H(added) column lists the number of hydrogen atoms added and optimized by MolProbity. The Clashes column lists the number of clashes within the asymmetric unit, whereas Symm-Clashes lists symmetry-related clashes.

Mol	Chain	Non-H	H(model)	H(added)	Clashes	Symm-Clashes
1	K1	1559	0	1531	43	0
1	K2	1559	0	1531	43	0
1	K3	1559	0	1531	37	0
1	K4	1559	0	1531	46	0
1	K5	1559	0	1531	57	0
2	C1	2932	0	2918	100	0
2	C2	2932	0	2918	72	0
2	C3	2932	0	2918	70	0
2	C4	2932	0	2918	96	0
2	C5	2932	0	2918	99	0
3	B1	2607	0	2510	78	0
3	B2	2607	0	2510	90	0
3	B3	2607	0	2510	80	0
3	B4	2607	0	2510	83	0
3	B5	2607	0	2510	88	0
4	G1	480	0	488	18	0
4	G2	480	0	488	25	0
4	G3	480	0	488	16	0
4	G4	480	0	488	14	0
4	G5	480	0	488	14	0
All	All	37890	0	37235	1096	0

The all-atom clashscore is defined as the number of clashes found per 1000 atoms (including hydrogen atoms). The all-atom clashscore for this structure is 15.

All (1096) close contacts within the same asymmetric unit are listed below, sorted by their clash magnitude.

Atom-1	Atom-2	Interatomic distance (Å)	Clash overlap (Å)
3:B3:79:LEU:HG	3:B3:95:LEU:HD11	1.60	0.84
2:C4:266:ARG:HA	2:C4:270:SER:HB2	1.61	0.83
3:B1:79:LEU:HG	3:B1:95:LEU:HD11	1.60	0.81
2:C5:181:GLY:HA2	2:C5:184:ARG:HD2	1.63	0.81
1:K4:64:ARG:HH21	1:K4:106:LEU:HA	1.46	0.80
3:B3:104:ALA:HB3	3:B3:113:ALA:HB3	1.64	0.79
1:K2:72:ARG:HH12	1:K2:77:ASP:HB2	1.47	0.78
2:C2:202:GLU:HA	2:C2:206:GLU:HB3	1.65	0.78
3:B5:65:THR:HG21	3:B5:107:PRO:HA	1.67	0.77
2:C2:266:ARG:O	2:C2:266:ARG:NH1	2.19	0.76
3:B1:198:LEU:HB3	3:B1:210:LEU:HD11	1.68	0.76
2:C5:90:ARG:HH21	2:C5:157:ILE:HD13	1.51	0.76
2:C4:202:GLU:HA	2:C4:206:GLU:HB3	1.67	0.76
2:C2:308:ASN:HA	2:C2:311:LYS:HD3	1.68	0.75
3:B4:114:CYS:SG	3:B4:122:SER:OG	2.45	0.75
3:B2:104:ALA:HB3	3:B2:113:ALA:HB3	1.68	0.74
2:C1:120:ARG:HE	2:C1:139:VAL:HG23	1.53	0.74
2:C1:77:LEU:HD22	2:C1:123:LEU:HD22	1.70	0.73
1:K4:175:MET:O	3:B4:132:ASN:ND2	2.21	0.72
3:B3:44:GLN:O	3:B3:46:ARG:NH1	2.22	0.72
2:C5:313:MET:SD	2:C5:313:MET:N	2.63	0.72
3:B2:46:ARG:HH12	3:B2:47:THR:HG22	1.54	0.72
3:B4:168:LEU:HB3	3:B4:178:THR:HB	1.71	0.72
3:B4:104:ALA:HB3	3:B4:113:ALA:HB3	1.71	0.72
2:C3:106:ASN:HA	2:C3:189:MET:HE1	1.71	0.72
2:C5:166:LEU:HD22	2:C5:212:MET:HG2	1.70	0.72
3:B2:79:LEU:HG	3:B2:95:LEU:HD21	1.72	0.72
2:C4:184:ARG:NH1	2:C4:251:CYS:O	2.23	0.71
2:C5:191:MET:HB3	2:C5:198:ARG:HD3	1.72	0.71
1:K3:80:LEU:HD23	2:C3:54:PHE:HB3	1.72	0.71
2:C4:185:ASN:O	2:C4:189:MET:HG3	1.91	0.71
2:C1:100:ASN:HD22	2:C1:103:GLN:HB3	1.56	0.70
1:K2:198:GLN:HE21	1:K2:199:ALA:H	1.39	0.69
2:C5:182:ALA:HA	2:C5:185:ASN:HD21	1.57	0.69
1:K3:71:TYR:O	1:K3:75:GLN:NE2	2.26	0.69
3:B4:5:ASP:OD2	3:B4:6:GLN:N	2.26	0.69
1:K5:67:LYS:HD2	1:K5:132:THR:H	1.55	0.69

*Continued on next page...*

*Continued from previous page...*

Atom-1	Atom-2	Interatomic distance (Å)	Clash overlap (Å)
3:B3:227:SER:HB2	3:B3:246:ASP:HB2	1.74	0.69
3:B5:44:GLN:O	3:B5:46:ARG:NH1	2.24	0.69
2:C3:184:ARG:CZ	2:C3:184:ARG:HA	2.22	0.68
1:K1:184:LEU:HD11	1:K1:201:PHE:HB3	1.75	0.68
2:C3:248:VAL:HG21	2:C3:257:GLU:HA	1.74	0.68
3:B2:198:LEU:HD12	3:B2:210:LEU:HG	1.75	0.68
3:B5:105:TYR:HE1	3:B5:109:GLY:HA2	1.58	0.67
2:C5:52:LEU:HD13	2:C5:57:LEU:HD11	1.77	0.67
2:C2:77:LEU:HD22	2:C2:123:LEU:HD22	1.76	0.67
3:B2:295:ASN:HD21	3:B2:304:ARG:HG3	1.59	0.67
4:G1:25:ILE:O	4:G1:27:ARG:NH1	2.28	0.67
1:K3:105:TYR:HB2	1:K3:111:LEU:HB3	1.76	0.66
2:C2:25:MET:SD	2:C2:25:MET:N	2.63	0.66
3:B4:199:PHE:HD2	3:B4:213:VAL:HG12	1.60	0.66
2:C2:185:ASN:O	2:C2:189:MET:HB2	1.95	0.66
2:C2:217:PHE:HB3	2:C2:268:LEU:HD21	1.76	0.66
1:K1:223:LYS:HD2	1:K1:226:ILE:HD11	1.78	0.66
1:K5:58:THR:O	1:K5:61:THR:OG1	2.13	0.66
2:C4:184:ARG:NH2	2:C4:253:ASP:OD1	2.29	0.66
3:B4:101:MET:SD	3:B4:116:GLY:HA2	2.36	0.66
3:B5:280:LYS:HD3	4:G5:48:ASP:HA	1.78	0.66
2:C4:60:ASN:O	2:C4:64:MET:HG3	1.95	0.66
3:B3:198:LEU:HB3	3:B3:210:LEU:HD11	1.77	0.66
3:B5:153:ASP:OD1	3:B5:155:ASN:N	2.29	0.66
2:C5:233:TYR:HE2	2:C5:276:ILE:HD11	1.61	0.66
3:B1:199:PHE:HD2	3:B1:213:VAL:HG12	1.60	0.66
3:B4:266:HIS:NE2	3:B4:268:ASN:OD1	2.28	0.65
1:K3:152:VAL:HG11	1:K3:156:HIS:CD2	2.31	0.65
1:K5:184:LEU:HD11	1:K5:201:PHE:HB3	1.77	0.65
3:B2:250:CYS:HB3	3:B2:264:TYR:HB2	1.78	0.65
2:C5:109:TRP:HZ2	2:C5:192:ILE:HD11	1.62	0.65
2:C4:38:LYS:HD2	2:C4:80:VAL:HG21	1.78	0.65
2:C1:185:ASN:O	2:C1:188:GLN:NE2	2.30	0.65
3:B4:271:CYS:HB3	3:B4:290:ASP:HB2	1.79	0.65
4:G1:9:ILE:HD12	4:G1:10:ALA:N	2.13	0.64
2:C3:25:MET:SD	2:C3:25:MET:N	2.70	0.64
3:B2:38:ASP:O	3:B2:283:ARG:NH2	2.31	0.64
3:B2:325:MET:HA	4:G2:49:PRO:HG2	1.79	0.64
4:G2:59:ASN:OD1	4:G2:62:ARG:N	2.29	0.64
2:C5:365:LEU:HD12	2:C5:368:GLN:HE21	1.62	0.64
3:B2:212:ASP:OD2	3:B2:219:ARG:NH2	2.28	0.64

*Continued on next page...*



*Continued from previous page...*

Atom-1	Atom-2	Interatomic distance (Å)	Clash overlap (Å)
4:G5:8:SER:O	4:G5:11:GLN:NE2	2.29	0.64
1:K4:45:TRP:CD1	1:K4:58:THR:HA	2.32	0.64
1:K3:152:VAL:HG13	1:K3:155:LYS:HA	1.79	0.64
2:C5:53:SER:OG	2:C5:55:GLU:OE2	2.14	0.64
2:C2:78:ARG:HG3	2:C2:146:ILE:HD11	1.78	0.64
3:B4:38:ASP:O	3:B4:283:ARG:NH2	2.31	0.64
1:K1:72:ARG:NH2	2:C1:118:MET:SD	2.70	0.64
2:C3:33:ILE:HD11	2:C3:60:ASN:HA	1.80	0.64
2:C5:356:LEU:HB3	2:C5:367:LYS:HZ1	1.63	0.64
3:B2:321:THR:OG1	3:B2:323:ASP:OD1	2.10	0.64
2:C2:94:LEU:HD21	2:C2:154:TYR:HE1	1.63	0.64
2:C4:254:LYS:HE3	2:C4:254:LYS:HA	1.79	0.64
3:B2:46:ARG:NH1	3:B2:47:THR:H	1.96	0.64
3:B2:265:SER:HA	3:B2:269:ILE:HD11	1.81	0.63
2:C1:340:ASP:HA	2:C1:344:GLY:HA3	1.80	0.63
3:B1:32:GLN:OE1	3:B1:32:GLN:N	2.30	0.63
1:K3:51:GLY:HA3	1:K3:96:PRO:HD3	1.79	0.63
2:C3:277:VAL:HG23	2:C3:278:GLU:HG3	1.81	0.63
1:K4:62:LEU:HA	1:K4:106:LEU:HD11	1.81	0.63
3:B4:198:LEU:HD12	3:B4:210:LEU:HG	1.79	0.62
1:K5:105:TYR:O	1:K5:109:GLY:N	2.28	0.62
2:C5:181:GLY:O	2:C5:185:ASN:ND2	2.33	0.62
2:C4:173:ARG:HH12	2:C4:213:SER:HA	1.63	0.62
3:B3:42:ARG:NH1	3:B3:305:ALA:O	2.32	0.62
4:G5:18:GLN:HA	4:G5:21:MET:SD	2.40	0.62
2:C2:59:ARG:O	2:C2:63:THR:HG23	2.00	0.62
2:C3:79:GLU:HB2	4:G4:2:ALA:HB3	1.82	0.62
3:B1:16:ASN:OD1	3:B1:19:ARG:NH2	2.32	0.62
2:C4:249:MET:HA	2:C4:254:LYS:NZ	2.14	0.62
3:B2:101:MET:SD	3:B2:101:MET:N	2.73	0.62
1:K5:67:LYS:HD2	1:K5:132:THR:N	2.13	0.62
3:B1:101:MET:SD	3:B1:116:GLY:HA2	2.40	0.62
1:K4:132:THR:HA	1:K4:135:ILE:HD12	1.81	0.62
1:K5:223:LYS:HA	1:K5:226:ILE:HD12	1.81	0.62
2:C3:167:ASP:O	2:C3:171:ARG:HG2	1.99	0.62
2:C4:44:ILE:HD11	2:C4:118:MET:HB3	1.82	0.62
1:K3:198:GLN:OE1	3:B3:52:ARG:NH1	2.33	0.62
2:C1:260:ILE:O	2:C1:264:VAL:HG23	2.00	0.62
3:B1:164:THR:H	3:B1:186:ASP:HA	1.65	0.62
2:C1:181:GLY:HA2	2:C1:184:ARG:NE	2.15	0.61
1:K2:155:LYS:O	1:K2:209:LEU:N	2.32	0.61

*Continued on next page...*

*Continued from previous page...*

Atom-1	Atom-2	Interatomic distance (Å)	Clash overlap (Å)
3:B4:262:MET:HE1	3:B4:300:LEU:HA	1.82	0.61
2:C2:212:MET:SD	2:C2:213:SER:N	2.73	0.61
3:B2:169:TRP:HA	3:B2:176:GLN:HA	1.80	0.61
3:B2:128:THR:HG22	3:B2:130:GLU:H	1.66	0.61
1:K1:95:ASP:OD2	1:K1:97:THR:OG1	2.17	0.61
2:C1:45:GLN:HB3	2:C1:84:HIS:CD2	2.35	0.61
2:C1:71:GLU:HG2	2:C1:72:LYS:HD3	1.83	0.61
2:C2:306:VAL:HG23	2:C2:308:ASN:H	1.65	0.61
3:B1:46:ARG:HH22	3:B1:47:THR:HG22	1.65	0.61
1:K3:62:LEU:HA	1:K3:106:LEU:HD13	1.82	0.61
3:B2:146:LEU:HD13	3:B2:161:SER:HB3	1.82	0.61
3:B2:215:GLU:OE2	3:B2:215:GLU:N	2.34	0.61
3:B4:57:LYS:HB3	3:B4:332:TRP:CD1	2.36	0.61
3:B5:313:ASN:OD1	3:B5:314:ARG:N	2.33	0.61
2:C1:29:TYR:O	2:C1:33:ILE:HG23	2.00	0.61
3:B1:101:MET:SD	3:B1:101:MET:N	2.73	0.61
1:K4:48:LEU:HD11	1:K4:92:ILE:HG12	1.82	0.60
2:C3:60:ASN:O	2:C3:64:MET:HG3	2.01	0.60
3:B5:100:VAL:HA	3:B5:116:GLY:HA3	1.82	0.60
2:C2:112:HIS:ND1	2:C2:113:GLN:OE1	2.34	0.60
4:G1:4:ASN:ND2	4:G1:9:ILE:HG12	2.17	0.60
2:C5:263:VAL:HA	2:C5:266:ARG:HD3	1.84	0.60
1:K1:167:GLU:OE2	1:K1:170:GLN:NE2	2.26	0.60
2:C4:118:MET:O	2:C4:122:ILE:HD12	2.00	0.60
3:B1:297:TRP:HE3	3:B1:304:ARG:HA	1.65	0.60
3:B4:39:PRO:HA	3:B4:301:LYS:HE3	1.82	0.60
3:B5:199:PHE:HD2	3:B5:213:VAL:HG12	1.65	0.60
1:K2:162:GLN:NE2	1:K2:199:ALA:HA	2.16	0.60
3:B4:212:ASP:OD1	3:B4:214:ARG:NH2	2.33	0.60
1:K4:107:ARG:O	2:C3:59:ARG:NH1	2.34	0.60
4:G1:14:LYS:NZ	4:G1:18:GLN:HB2	2.17	0.60
2:C5:297:GLY:O	2:C5:301:LYS:HG2	2.01	0.60
3:B5:75:GLN:O	3:B5:98:SER:OG	2.18	0.60
1:K4:181:PHE:HZ	1:K4:184:LEU:HB2	1.67	0.59
1:K5:49:ASN:HB3	1:K5:91:LEU:HA	1.83	0.59
2:C1:61:ALA:O	2:C1:65:VAL:HG13	2.01	0.59
2:C4:64:MET:HB2	2:C4:73:LEU:HD11	1.83	0.59
3:B1:280:LYS:HB2	3:B1:324:GLY:HA3	1.85	0.59
3:B3:81:ILE:HD12	3:B3:91:HIS:HB2	1.84	0.59
4:G5:14:LYS:HD2	4:G5:15:LEU:N	2.16	0.59
2:C5:160:HIS:HA	2:C5:163:GLN:HE21	1.67	0.59

*Continued on next page...*

*Continued from previous page...*

Atom-1	Atom-2	Interatomic distance (Å)	Clash overlap (Å)
3:B1:42:ARG:HH11	3:B1:42:ARG:HA	1.67	0.59
2:C4:94:LEU:HD21	2:C4:154:TYR:HE1	1.66	0.59
3:B2:29:THR:HB	3:B2:32:GLN:HG2	1.83	0.59
2:C1:82:THR:O	2:C1:86:ILE:HG12	2.03	0.59
2:C3:253:ASP:HB3	2:C3:256:THR:HG23	1.85	0.59
2:C5:82:THR:O	2:C5:86:ILE:HG12	2.03	0.59
3:B3:297:TRP:HA	3:B3:305:ALA:H	1.67	0.59
2:C5:293:THR:HG23	2:C5:359:SER:HB2	1.84	0.59
3:B2:165:THR:HG22	3:B2:167:ALA:H	1.67	0.59
2:C1:317:MET:HE3	2:C1:321:LEU:HB2	1.84	0.59
2:C4:184:ARG:CZ	2:C4:184:ARG:HA	2.33	0.58
3:B5:101:MET:N	3:B5:101:MET:SD	2.77	0.58
1:K1:83:ASP:HA	1:K1:91:LEU:H	1.67	0.58
2:C5:62:TYR:CE1	2:C5:125:TYR:HB2	2.38	0.58
1:K3:65:ASP:OD2	1:K3:67:LYS:NZ	2.36	0.58
1:K4:229:GLU:OE2	1:K4:233:ARG:NH1	2.35	0.58
3:B1:46:ARG:NH1	3:B1:47:THR:H	2.01	0.58
1:K3:104:ASN:O	1:K3:108:HIS:ND1	2.34	0.58
2:C5:294:GLU:OE1	2:C5:294:GLU:N	2.35	0.58
3:B2:152:LEU:HD11	3:B2:168:LEU:HD11	1.84	0.58
2:C5:90:ARG:HA	2:C5:90:ARG:CZ	2.34	0.58
2:C5:362:ASN:HA	2:C5:367:LYS:HE3	1.85	0.58
3:B2:123:ILE:HD11	3:B2:151:PHE:HE1	1.68	0.58
3:B5:101:MET:SD	3:B5:116:GLY:HA2	2.43	0.58
4:G1:14:LYS:HZ3	4:G1:18:GLN:HB2	1.68	0.58
1:K2:64:ARG:HD3	1:K2:106:LEU:HD12	1.86	0.57
1:K2:198:GLN:NE2	1:K2:199:ALA:H	1.99	0.57
1:K5:72:ARG:NE	1:K5:77:ASP:OD1	2.37	0.57
3:B3:325:MET:HE3	4:G3:49:PRO:HB3	1.86	0.57
3:B4:57:LYS:HD3	3:B4:332:TRP:CD2	2.39	0.57
2:C5:352:PHE:O	2:C5:356:LEU:HG	2.04	0.57
3:B2:123:ILE:HD11	3:B2:151:PHE:CE1	2.39	0.57
2:C1:234:ILE:HG23	2:C1:302:LEU:HD22	1.87	0.57
2:C3:78:ARG:HG2	2:C3:142:LEU:HD21	1.86	0.57
3:B5:104:ALA:HB3	3:B5:113:ALA:HB3	1.86	0.57
4:G2:16:VAL:O	4:G2:20:LYS:HG2	2.05	0.57
2:C1:185:ASN:HA	2:C1:188:GLN:HE21	1.69	0.57
2:C4:109:TRP:CH2	2:C4:192:ILE:HD11	2.38	0.57
2:C4:241:ILE:O	2:C4:245:ILE:HG12	2.04	0.57
4:G5:22:GLU:HA	4:G5:25:ILE:HD12	1.84	0.57
2:C3:247:ARG:O	2:C3:251:CYS:N	2.23	0.57

*Continued on next page...*

*Continued from previous page...*

Atom-1	Atom-2	Interatomic distance (Å)	Clash overlap (Å)
3:B2:44:GLN:OE1	3:B2:44:GLN:N	2.34	0.57
2:C1:241:ILE:O	2:C1:245:ILE:HG12	2.05	0.57
2:C5:59:ARG:O	2:C5:63:THR:OG1	2.21	0.57
2:C5:249:MET:HE2	2:C5:249:MET:N	2.18	0.57
2:C1:230:ALA:O	2:C1:234:ILE:HG12	2.04	0.57
1:K5:60:GLN:HA	1:K5:63:CYS:HB2	1.85	0.57
2:C5:34:TRP:HZ2	2:C5:76:GLY:HA3	1.69	0.57
1:K4:101:PRO:HB2	1:K4:122:VAL:HG21	1.86	0.57
2:C3:79:GLU:O	2:C3:83:GLU:HG2	2.05	0.56
3:B5:107:PRO:HD3	3:B5:151:PHE:HB3	1.87	0.56
1:K4:167:GLU:O	1:K4:171:MET:HG3	2.04	0.56
2:C4:365:LEU:O	2:C4:369:THR:HG22	2.05	0.56
2:C5:356:LEU:HD22	2:C5:367:LYS:HZ2	1.70	0.56
3:B3:137:ARG:NH1	3:B3:138:GLU:OE1	2.39	0.56
1:K1:70:LEU:HD23	1:K1:73:LEU:HD12	1.87	0.56
1:K4:93:ASP:OD2	1:K5:58:THR:OG1	2.22	0.56
2:C4:159:ASP:OD1	2:C4:160:HIS:N	2.39	0.56
2:C4:321:LEU:HD13	2:C4:352:PHE:HE2	1.71	0.56
2:C5:132:GLN:CD	2:C5:132:GLN:H	2.08	0.56
3:B3:325:MET:HG2	4:G3:60:PRO:HD2	1.88	0.56
3:B5:57:LYS:HB3	3:B5:332:TRP:CD1	2.39	0.56
4:G2:56:ALA:HA	4:G2:59:ASN:HD21	1.69	0.56
1:K5:147:SER:HA	1:K5:150:SER:HB2	1.86	0.56
2:C2:172:GLU:HG3	2:C2:177:VAL:HG13	1.86	0.56
3:B4:164:THR:HA	3:B4:187:VAL:HG23	1.88	0.56
2:C1:166:LEU:HD23	2:C1:169:ILE:HD11	1.87	0.56
3:B3:108:SER:OG	3:B3:110:ASN:ND2	2.39	0.56
3:B5:12:GLU:O	3:B5:15:LYS:HG2	2.04	0.56
4:G2:8:SER:HB2	4:G2:11:GLN:HE21	1.69	0.56
1:K4:95:ASP:OD2	1:K4:97:THR:OG1	2.19	0.56
2:C2:233:TYR:OH	2:C2:268:LEU:O	2.23	0.56
1:K5:168:LEU:HD11	1:K5:184:LEU:HD21	1.88	0.56
2:C2:168:MET:HA	2:C2:171:ARG:HG2	1.87	0.56
3:B2:124:TYR:HD2	3:B2:135:VAL:HA	1.71	0.56
2:C3:54:PHE:CE2	2:C3:58:TYR:HE1	2.23	0.56
1:K3:44:LYS:NZ	1:K3:60:GLN:OE1	2.39	0.56
2:C1:180:ARG:O	2:C1:184:ARG:HG3	2.06	0.56
3:B3:57:LYS:HB3	3:B3:332:TRP:CD1	2.41	0.56
2:C3:244:GLU:HG3	2:C3:264:VAL:HG21	1.88	0.55
2:C5:34:TRP:CZ3	2:C5:73:LEU:HD13	2.42	0.55
3:B5:47:THR:HA	3:B5:338:ILE:O	2.06	0.55

*Continued on next page...*

*Continued from previous page...*

Atom-1	Atom-2	Interatomic distance (Å)	Clash overlap (Å)
2:C1:33:ILE:HD11	2:C1:64:MET:HB2	1.88	0.55
2:C1:349:LYS:NZ	2:C1:353:ASP:OD1	2.37	0.55
3:B3:250:CYS:O	3:B3:264:TYR:N	2.39	0.55
3:B3:251:ARG:HB3	3:B3:260:GLU:HG3	1.88	0.55
2:C4:79:GLU:O	2:C4:83:GLU:HG3	2.07	0.55
3:B5:215:GLU:OE2	3:B5:216:GLY:N	2.40	0.55
4:G5:34:ALA:O	4:G5:38:MET:HG3	2.06	0.55
1:K2:50:VAL:O	1:K2:96:PRO:HG3	2.07	0.55
1:K5:66:PRO:HA	1:K5:71:TYR:CD2	2.42	0.55
3:B3:101:MET:SD	3:B3:116:GLY:HA2	2.47	0.55
1:K4:223:LYS:HA	1:K4:226:ILE:HD12	1.87	0.55
2:C1:284:LEU:HD13	2:C1:299:MET:SD	2.46	0.55
3:B4:266:HIS:O	3:B4:269:ILE:HG13	2.07	0.55
3:B1:57:LYS:HB3	3:B1:332:TRP:CD1	2.42	0.55
3:B4:160:SER:HB3	3:B4:190:LEU:HD13	1.88	0.55
4:G2:20:LYS:HB2	4:G2:21:MET:CE	2.37	0.55
4:G3:2:ALA:HA	4:G3:6:THR:H	1.70	0.55
1:K3:168:LEU:HD11	1:K3:184:LEU:HD21	1.89	0.55
2:C2:164:THR:HG22	2:C2:168:MET:HE3	1.89	0.55
2:C3:167:ASP:O	2:C3:171:ARG:NH1	2.39	0.55
2:C4:190:LEU:HG	2:C4:201:TYR:HA	1.89	0.55
2:C5:61:ALA:O	2:C5:65:VAL:HG23	2.07	0.55
2:C5:284:LEU:HD13	2:C5:299:MET:HG3	1.88	0.55
3:B1:198:LEU:HD23	3:B1:212:ASP:HA	1.89	0.55
1:K3:104:ASN:HB3	1:K3:108:HIS:HE1	1.71	0.54
2:C1:230:ALA:HB3	2:C1:282:SER:HB3	1.89	0.54
2:C2:87:ASN:OD1	2:C2:88:LYS:N	2.40	0.54
2:C5:86:ILE:HA	2:C5:90:ARG:HG2	1.88	0.54
1:K5:181:PHE:HA	1:K5:205:VAL:HG12	1.89	0.54
2:C2:293:THR:O	2:C2:359:SER:OG	2.23	0.54
2:C4:319:SER:HA	2:C4:322:ARG:HD2	1.88	0.54
2:C5:263:VAL:O	2:C5:266:ARG:HG2	2.07	0.54
3:B2:252:LEU:O	3:B2:261:LEU:N	2.39	0.54
1:K3:197:ASP:OD1	1:K3:198:GLN:NE2	2.40	0.54
2:C2:81:VAL:O	2:C2:85:LEU:HG	2.07	0.54
1:K5:155:LYS:HA	1:K5:209:LEU:HB2	1.89	0.54
3:B2:121:CYS:HB3	3:B2:139:LEU:HB2	1.88	0.54
3:B2:142:HIS:HE2	3:B2:159:THR:HG1	1.52	0.54
4:G4:25:ILE:O	4:G4:27:ARG:NH1	2.40	0.54
1:K2:184:LEU:HD11	1:K2:201:PHE:HB3	1.89	0.54
3:B2:168:LEU:O	3:B2:177:THR:N	2.27	0.54

*Continued on next page...*

*Continued from previous page...*

Atom-1	Atom-2	Interatomic distance (Å)	Clash overlap (Å)
3:B5:250:CYS:SG	3:B5:251:ARG:N	2.80	0.54
3:B4:121:CYS:HB3	3:B4:139:LEU:HB2	1.88	0.54
1:K1:210:HIS:H	1:K5:151:GLN:HB3	1.72	0.54
3:B3:256:ARG:HH21	4:G3:33:ALA:HA	1.71	0.54
2:C1:181:GLY:HA2	2:C1:184:ARG:HE	1.73	0.54
2:C5:185:ASN:HA	2:C5:188:GLN:HE21	1.73	0.54
3:B4:49:ARG:HB2	3:B4:338:ILE:HB	1.89	0.54
1:K4:80:LEU:HB2	1:K4:90:TYR:CE2	2.43	0.54
2:C4:40:ALA:O	2:C4:44:ILE:HG22	2.08	0.54
3:B3:112:VAL:HB	3:B3:126:LEU:HD11	1.89	0.54
3:B3:200:VAL:HG13	3:B3:232:ILE:HG21	1.90	0.54
3:B3:271:CYS:HB3	3:B3:290:ASP:HB2	1.90	0.54
3:B5:75:GLN:OE1	3:B5:75:GLN:N	2.33	0.54
3:B3:229:ILE:HG23	3:B3:243:THR:HG23	1.90	0.54
4:G3:34:ALA:HA	4:G3:37:LEU:HD12	1.89	0.54
3:B2:159:THR:O	3:B2:159:THR:OG1	2.25	0.53
1:K4:105:TYR:HB2	1:K4:111:LEU:HB3	1.90	0.53
2:C1:87:ASN:OD1	2:C1:88:LYS:N	2.41	0.53
2:C3:221:SER:HB3	2:C3:268:LEU:HG	1.89	0.53
2:C3:282:SER:O	2:C3:286:HIS:ND1	2.41	0.53
3:B2:320:VAL:HG12	3:B2:327:VAL:HB	1.90	0.53
3:B4:54:HIS:ND1	3:B4:74:SER:HB3	2.24	0.53
3:B4:269:ILE:HG12	3:B4:304:ARG:HH22	1.73	0.53
3:B5:79:LEU:HD21	3:B5:114:CYS:SG	2.48	0.53
3:B5:106:ALA:HB2	3:B5:111:TYR:HB2	1.89	0.53
1:K1:113:ILE:HG22	1:K1:122:VAL:HG11	1.91	0.53
2:C4:126:MET:O	2:C4:131:VAL:HG23	2.08	0.53
2:C5:80:VAL:HA	2:C5:83:GLU:OE2	2.07	0.53
3:B2:188:MET:SD	3:B2:230:ASN:HA	2.48	0.53
3:B5:253:PHE:HA	3:B5:260:GLU:HA	1.90	0.53
2:C5:34:TRP:CZ2	2:C5:76:GLY:HA3	2.44	0.53
1:K4:183:GLN:NE2	1:K4:184:LEU:O	2.41	0.53
1:K5:179:TRP:CE2	1:K5:207:LYS:HD2	2.43	0.53
2:C2:63:THR:HA	2:C2:66:LEU:HG	1.91	0.53
2:C4:124:MET:HB3	2:C4:128:ARG:NH1	2.23	0.53
3:B1:297:TRP:CE3	3:B1:304:ARG:HA	2.43	0.53
3:B5:54:HIS:CD2	3:B5:80:ILE:HD12	2.43	0.53
1:K1:164:GLN:HE22	1:K1:167:GLU:HB2	1.73	0.53
1:K2:95:ASP:HB3	1:K2:98:TYR:HB2	1.90	0.53
1:K5:93:ASP:O	1:K5:94:ARG:HB2	2.08	0.53
3:B5:331:SER:HB2	3:B5:333:ASP:OD1	2.09	0.53

*Continued on next page...*



*Continued from previous page...*

Atom-1	Atom-2	Interatomic distance (Å)	Clash overlap (Å)
2:C1:34:TRP:HB2	2:C1:64:MET:CE	2.39	0.53
2:C1:365:LEU:O	2:C1:369:THR:HG23	2.09	0.53
2:C2:173:ARG:HE	2:C2:247:ARG:HH21	1.55	0.53
2:C3:245:ILE:HA	2:C3:248:VAL:HG12	1.91	0.53
2:C3:260:ILE:O	2:C3:263:VAL:HB	2.09	0.53
2:C2:169:ILE:HG21	2:C2:209:PHE:HE1	1.73	0.53
2:C3:233:TYR:OH	2:C3:268:LEU:O	2.27	0.53
2:C3:237:VAL:HG12	2:C3:268:LEU:HD23	1.91	0.53
2:C5:63:THR:HG22	2:C5:67:HIS:NE2	2.23	0.53
3:B3:101:MET:SD	3:B3:101:MET:N	2.82	0.53
3:B4:197:ARG:O	3:B4:214:ARG:NH2	2.31	0.53
1:K5:128:PHE:HE1	2:C5:59:ARG:HG3	1.74	0.53
2:C1:166:LEU:HD22	2:C1:212:MET:HG2	1.91	0.53
2:C3:53:SER:HB3	2:C3:56:GLU:HB2	1.90	0.53
2:C5:120:ARG:O	2:C5:123:LEU:N	2.36	0.53
3:B1:57:LYS:HD3	3:B1:332:TRP:CD2	2.44	0.53
4:G1:46:LYS:HD2	4:G1:47:GLU:N	2.23	0.53
1:K1:165:GLU:OE1	1:K1:165:GLU:N	2.24	0.53
1:K5:98:TYR:CZ	1:K5:121:GLY:HA3	2.44	0.53
2:C1:164:THR:O	2:C1:168:MET:HE2	2.09	0.53
2:C5:184:ARG:NE	2:C5:250:HIS:O	2.37	0.53
3:B3:124:TYR:HD1	3:B3:135:VAL:HA	1.74	0.53
1:K1:178:GLY:HA3	1:K5:152:VAL:HG23	1.89	0.52
2:C1:210:LEU:HD21	2:C1:259:PRO:HB2	1.91	0.52
2:C1:324:GLN:HB3	2:C1:348:LEU:HD21	1.92	0.52
2:C3:228:ASN:HB3	2:C3:232:VAL:HG13	1.92	0.52
2:C3:356:LEU:HD13	2:C3:367:LYS:HG2	1.91	0.52
2:C4:300:TYR:O	2:C4:304:SER:N	2.41	0.52
2:C5:58:TYR:O	2:C5:62:TYR:HD2	1.91	0.52
3:B1:107:PRO:HD3	3:B1:151:PHE:HB3	1.91	0.52
3:B4:266:HIS:CD2	3:B4:268:ASN:H	2.27	0.52
1:K5:179:TRP:HA	1:K5:207:LYS:HB3	1.92	0.52
2:C1:217:PHE:CE2	2:C1:264:VAL:HG22	2.44	0.52
2:C1:256:THR:O	2:C1:260:ILE:HG22	2.09	0.52
3:B2:47:THR:HA	3:B2:338:ILE:O	2.08	0.52
4:G2:55:PRO:HD2	4:G2:58:GLU:HB2	1.91	0.52
4:G3:34:ALA:O	4:G3:38:MET:HE2	2.09	0.52
2:C4:110:ASN:O	2:C4:114:THR:HG23	2.09	0.52
4:G4:48:ASP:HB3	4:G4:51:LEU:HB2	1.90	0.52
1:K3:152:VAL:HG11	1:K3:156:HIS:HD2	1.74	0.52
1:K5:93:ASP:HB3	2:C5:59:ARG:CZ	2.40	0.52

*Continued on next page...*

*Continued from previous page...*

Atom-1	Atom-2	Interatomic distance (Å)	Clash overlap (Å)
2:C1:234:ILE:HD11	2:C1:276:ILE:HG21	1.91	0.52
2:C5:182:ALA:HA	2:C5:185:ASN:ND2	2.23	0.52
3:B2:313:ASN:OD1	3:B2:314:ARG:N	2.40	0.52
3:B5:38:ASP:O	3:B5:301:LYS:NZ	2.39	0.52
1:K2:50:VAL:HG11	1:K2:99:PHE:HB2	1.92	0.52
1:K5:132:THR:HA	1:K5:135:ILE:HD12	1.91	0.52
2:C4:338:PRO:HA	2:C4:341:TYR:HB3	1.92	0.52
3:B5:153:ASP:HB3	3:B5:156:GLN:HB2	1.91	0.52
1:K3:123:LEU:O	1:K3:127:GLU:HG2	2.09	0.52
2:C3:217:PHE:CE2	2:C3:264:VAL:HG22	2.45	0.52
3:B5:278:PHE:HB3	3:B5:282:GLY:HA2	1.91	0.52
1:K2:114:ASN:H	1:K2:117:LEU:HD12	1.73	0.52
2:C2:169:ILE:HD12	2:C2:205:PHE:HZ	1.75	0.52
2:C4:297:GLY:O	2:C4:301:LYS:HG2	2.10	0.52
2:C5:373:ASP:HA	2:C5:376:TYR:CD2	2.44	0.52
3:B3:183:HIS:HE1	3:B3:209:LYS:HB2	1.74	0.52
3:B4:14:LEU:HB3	4:G4:19:LEU:HB3	1.91	0.52
3:B4:45:MET:HB3	3:B4:339:TRP:HB3	1.90	0.52
2:C3:62:TYR:O	2:C3:66:LEU:HG	2.10	0.52
3:B1:5:ASP:HA	3:B1:8:ARG:NE	2.25	0.52
3:B2:4:LEU:HB3	3:B2:8:ARG:HH21	1.75	0.52
1:K3:230:ARG:HH21	3:B3:314:ARG:HH12	1.58	0.52
2:C1:248:VAL:HA	2:C1:252:LEU:HD12	1.92	0.52
2:C1:258:GLU:O	2:C1:262:LYS:HG2	2.10	0.52
3:B1:56:ALA:HB3	3:B1:74:SER:HB2	1.92	0.52
3:B1:250:CYS:HB3	3:B1:264:TYR:HB2	1.91	0.52
4:G1:35:ALA:HA	4:G1:38:MET:SD	2.50	0.52
4:G4:45:ALA:HB3	4:G4:46:LYS:NZ	2.25	0.52
1:K4:64:ARG:HD3	2:C3:59:ARG:HH22	1.74	0.52
2:C3:303:PHE:HA	2:C3:306:VAL:HG22	1.92	0.52
2:C5:317:MET:SD	2:C5:318:SER:N	2.83	0.52
3:B4:321:THR:OG1	3:B4:325:MET:N	2.43	0.52
1:K1:69:PHE:HB3	1:K1:129:TYR:CD1	2.44	0.51
2:C1:75:THR:O	2:C1:79:GLU:HG2	2.10	0.51
2:C1:239:ALA:HA	2:C1:242:ASN:HD21	1.75	0.51
2:C3:248:VAL:HA	2:C3:252:LEU:HB2	1.90	0.51
2:C4:85:LEU:HD21	2:C4:151:VAL:HG23	1.92	0.51
3:B4:48:ARG:N	3:B4:338:ILE:O	2.42	0.51
1:K2:72:ARG:HH12	1:K2:77:ASP:CB	2.20	0.51
2:C1:264:VAL:HG13	2:C1:268:LEU:HD12	1.91	0.51
2:C2:173:ARG:NH2	2:C2:244:GLU:OE2	2.43	0.51

*Continued on next page...*



Continued from previous page...

Atom-1	Atom-2	Interatomic distance (Å)	Clash overlap (Å)
2:C1:34:TRP:HB2	2:C1:64:MET:HE1	1.92	0.51
2:C3:312:THR:HA	2:C3:315:GLU:HG2	1.91	0.51
3:B1:129:ARG:NH2	3:B5:119:ASN:OD1	2.43	0.51
2:C2:85:LEU:HD13	2:C2:147:PHE:CD1	2.46	0.51
2:C4:126:MET:HE1	2:C4:139:VAL:HB	1.92	0.51
1:K4:183:GLN:HB3	1:K4:204:VAL:HB	1.92	0.51
2:C4:33:ILE:HG23	2:C4:64:MET:SD	2.50	0.51
2:C4:225:LEU:HD21	2:C4:276:ILE:HG12	1.91	0.51
2:C4:364:ARG:HA	2:C4:367:LYS:HE2	1.92	0.51
3:B1:5:ASP:OD1	3:B1:6:GLN:N	2.43	0.51
2:C1:98:ASN:OD1	2:C1:99:ASN:N	2.44	0.51
3:B3:124:TYR:CD1	3:B3:135:VAL:HA	2.46	0.51
3:B4:249:THR:HG22	3:B4:265:SER:HB2	1.93	0.51
1:K1:103:LEU:HG	1:K1:107:ARG:HD2	1.91	0.51
2:C4:59:ARG:O	2:C4:63:THR:HG22	2.10	0.51
2:C4:109:TRP:CZ3	2:C4:189:MET:HG2	2.46	0.51
3:B3:43:ILE:HB	3:B3:45:MET:HE1	1.92	0.51
3:B3:331:SER:HB2	3:B3:333:ASP:OD1	2.11	0.51
1:K5:131:ILE:HG22	1:K5:134:LEU:H	1.75	0.51
2:C4:257:GLU:O	2:C4:261:VAL:HG23	2.10	0.51
2:C5:120:ARG:NH1	2:C5:120:ARG:HB2	2.26	0.51
2:C5:248:VAL:HG21	2:C5:260:ILE:HD13	1.93	0.51
2:C5:356:LEU:HD11	2:C5:370:ILE:HD13	1.93	0.51
3:B3:29:THR:HB	3:B3:32:GLN:HG2	1.92	0.51
3:B3:61:MET:HG2	3:B3:317:CYS:HB3	1.92	0.51
3:B3:114:CYS:SG	3:B3:122:SER:HB2	2.51	0.51
3:B4:119:ASN:HB3	3:B4:142:HIS:O	2.11	0.51
3:B2:67:SER:HB2	3:B2:321:THR:HB	1.91	0.50
2:C1:85:LEU:HA	2:C1:89:VAL:HB	1.92	0.50
2:C4:248:VAL:HG22	2:C4:252:LEU:HD12	1.92	0.50
2:C5:168:MET:SD	2:C5:168:MET:N	2.85	0.50
3:B1:323:ASP:N	3:B1:323:ASP:OD1	2.44	0.50
3:B2:321:THR:HG23	3:B2:326:ALA:O	2.12	0.50
3:B4:199:PHE:CD2	3:B4:213:VAL:HG12	2.44	0.50
1:K4:42:VAL:HG22	1:K4:59:ARG:HD3	1.93	0.50
1:K5:108:HIS:CE1	1:K5:110:LYS:HB2	2.47	0.50
2:C5:202:GLU:HA	2:C5:206:GLU:HB3	1.94	0.50
3:B1:254:ASP:HB3	3:B1:257:ALA:HB3	1.94	0.50
3:B3:56:ALA:HB3	3:B3:74:SER:HB2	1.93	0.50
3:B1:54:HIS:CD2	3:B1:80:ILE:HD12	2.45	0.50
3:B5:212:ASP:OD1	3:B5:214:ARG:NE	2.32	0.50

Continued on next page...

*Continued from previous page...*

Atom-1	Atom-2	Interatomic distance (Å)	Clash overlap (Å)
4:G5:11:GLN:HA	4:G5:14:LYS:HG3	1.92	0.50
1:K1:56:LEU:HB2	1:K5:52:GLY:HA2	1.93	0.50
3:B2:14:LEU:HD11	4:G2:20:LYS:NZ	2.26	0.50
2:C1:69:HIS:CD2	2:C1:72:LYS:HE3	2.47	0.50
2:C4:218:GLN:O	2:C4:222:GLN:HG2	2.12	0.50
1:K1:98:TYR:HE2	1:K2:112:VAL:HG11	1.75	0.50
2:C4:218:GLN:O	2:C4:221:SER:OG	2.29	0.50
2:C5:225:LEU:HD21	2:C5:275:THR:HG21	1.93	0.50
3:B3:254:ASP:HB3	3:B3:257:ALA:HB3	1.93	0.50
4:G5:21:MET:O	4:G5:25:ILE:HG13	2.12	0.50
1:K5:128:PHE:CE1	2:C5:59:ARG:HG3	2.46	0.50
2:C1:97:LEU:HD22	2:C1:160:HIS:CE1	2.46	0.50
2:C5:233:TYR:CE2	2:C5:276:ILE:HD11	2.45	0.50
3:B2:5:ASP:OD1	3:B2:6:GLN:N	2.44	0.50
3:B2:166:CYS:SG	3:B2:187:VAL:HG11	2.52	0.50
3:B4:209:LYS:HB3	3:B4:218:CYS:SG	2.52	0.50
3:B5:46:ARG:HE	3:B5:48:ARG:NH2	2.09	0.50
1:K2:104:ASN:HB3	1:K2:108:HIS:HE1	1.77	0.50
3:B2:30:LEU:HD23	4:G2:35:ALA:HB2	1.94	0.50
3:B3:150:ARG:O	3:B3:157:ILE:HG13	2.12	0.50
3:B3:328:ALA:HB1	3:B3:336:LEU:HD21	1.94	0.50
3:B4:65:THR:OG1	3:B4:107:PRO:O	2.30	0.50
1:K4:130:ASN:HB2	2:C4:128:ARG:NE	2.27	0.49
3:B5:160:SER:HA	3:B5:166:CYS:HA	1.94	0.49
4:G2:56:ALA:HA	4:G2:59:ASN:ND2	2.26	0.49
2:C3:184:ARG:O	2:C3:188:GLN:HG2	2.11	0.49
2:C5:79:GLU:O	2:C5:83:GLU:HG3	2.12	0.49
2:C5:279:MET:HG3	2:C5:282:SER:OG	2.12	0.49
3:B4:130:GLU:CD	3:B4:130:GLU:H	2.15	0.49
3:B2:148:CYS:SG	3:B2:150:ARG:NH1	2.85	0.49
1:K3:96:PRO:HA	1:K3:99:PHE:HB3	1.94	0.49
2:C2:98:ASN:OD1	2:C2:99:ASN:N	2.45	0.49
3:B2:168:LEU:HD23	3:B2:177:THR:HB	1.93	0.49
3:B3:250:CYS:HB3	3:B3:264:TYR:HB2	1.93	0.49
3:B4:78:LYS:HA	3:B4:95:LEU:HD23	1.94	0.49
3:B4:215:GLU:N	3:B4:215:GLU:OE1	2.46	0.49
1:K1:132:THR:HA	1:K1:135:ILE:HD12	1.95	0.49
2:C1:25:MET:SD	2:C1:25:MET:N	2.86	0.49
2:C4:109:TRP:HH2	2:C4:192:ILE:HD11	1.77	0.49
3:B1:67:SER:HB2	3:B1:321:THR:HB	1.93	0.49
2:C5:33:ILE:HG23	2:C5:64:MET:HE1	1.94	0.49

*Continued on next page...*

*Continued from previous page...*

Atom-1	Atom-2	Interatomic distance (Å)	Clash overlap (Å)
3:B1:104:ALA:HB3	3:B1:113:ALA:HB3	1.94	0.49
1:K1:113:ILE:HD13	1:K1:119:GLU:HB3	1.95	0.49
2:C4:206:GLU:OE1	2:C4:207:ALA:N	2.45	0.49
4:G2:4:ASN:OD1	4:G2:9:ILE:HG12	2.11	0.49
1:K1:158:TYR:CE1	1:K2:181:PHE:HB3	2.48	0.49
1:K3:49:ASN:HB3	1:K3:91:LEU:HD23	1.94	0.49
2:C1:62:TYR:CZ	2:C1:125:TYR:HB2	2.47	0.49
2:C5:207:ALA:O	2:C5:210:LEU:HG	2.13	0.49
2:C5:230:ALA:O	2:C5:234:ILE:HG12	2.13	0.49
3:B1:223:THR:HG22	3:B1:224:GLY:H	1.77	0.49
4:G3:54:VAL:HG12	4:G3:58:GLU:HB3	1.95	0.49
1:K5:157:VAL:HB	1:K5:209:LEU:HD11	1.94	0.49
3:B3:42:ARG:HH22	3:B3:306:GLY:HA2	1.78	0.49
3:B5:222:PHE:HB3	3:B5:253:PHE:CD1	2.48	0.49
4:G5:4:ASN:ND2	4:G5:7:ALA:HA	2.28	0.49
2:C2:242:ASN:O	2:C2:245:ILE:HG13	2.13	0.48
4:G4:17:GLU:O	4:G4:20:LYS:N	2.46	0.48
3:B2:31:SER:H	4:G2:34:ALA:HB1	1.77	0.48
3:B3:262:MET:SD	3:B3:302:ALA:HB2	2.53	0.48
1:K2:64:ARG:NH2	1:K2:109:GLY:HA2	2.29	0.48
1:K5:120:GLU:H	1:K5:120:GLU:CD	2.17	0.48
2:C3:247:ARG:HG3	2:C3:251:CYS:HB3	1.94	0.48
3:B5:124:TYR:HA	3:B5:135:VAL:HA	1.94	0.48
4:G4:42:GLU:O	4:G4:46:LYS:NZ	2.42	0.48
2:C3:171:ARG:HE	2:C3:174:LYS:HE2	1.79	0.48
2:C4:137:GLU:HB3	2:C4:141:ASN:OD1	2.13	0.48
2:C5:34:TRP:HZ3	2:C5:73:LEU:HD13	1.76	0.48
1:K2:183:GLN:OE1	1:K2:185:VAL:HG13	2.13	0.48
1:K2:192:ASN:CG	1:K2:193:TYR:H	2.17	0.48
1:K3:164:GLN:HA	1:K3:200:GLU:HB3	1.96	0.48
2:C1:246:GLU:HG2	2:C1:250:HIS:CE1	2.48	0.48
3:B5:183:HIS:CE1	3:B5:209:LYS:HB2	2.49	0.48
2:C1:185:ASN:CA	2:C1:188:GLN:HE21	2.26	0.48
2:C2:284:LEU:HG	2:C2:317:MET:HE1	1.94	0.48
2:C5:79:GLU:HG3	2:C5:80:VAL:N	2.29	0.48
1:K2:160:VAL:HG22	1:K2:204:VAL:HG22	1.95	0.48
2:C3:30:VAL:HA	2:C3:33:ILE:HG22	1.96	0.48
2:C3:75:THR:HA	2:C3:78:ARG:HE	1.78	0.48
2:C4:123:LEU:HB3	2:C4:126:MET:HE3	1.96	0.48
2:C4:168:MET:SD	2:C4:171:ARG:NH2	2.87	0.48
4:G1:16:VAL:O	4:G1:20:LYS:HG2	2.14	0.48

*Continued on next page...*

*Continued from previous page...*

Atom-1	Atom-2	Interatomic distance (Å)	Clash overlap (Å)
1:K2:148:LYS:HA	1:K2:212:THR:HG21	1.95	0.48
2:C4:75:THR:O	2:C4:79:GLU:HG2	2.14	0.48
2:C5:353:ASP:HA	2:C5:356:LEU:HD12	1.96	0.48
3:B2:200:VAL:HG12	3:B2:234:PHE:CE2	2.48	0.48
3:B3:298:ASP:HB3	3:B3:301:LYS:HB2	1.96	0.48
3:B4:230:ASN:H	3:B4:245:SER:HA	1.79	0.48
1:K2:130:ASN:ND2	2:C2:58:TYR:OH	2.46	0.48
3:B4:166:CYS:SG	3:B4:187:VAL:HG11	2.54	0.48
1:K1:49:ASN:HB3	1:K1:91:LEU:HA	1.96	0.48
1:K4:84:LYS:HE3	1:K4:91:LEU:HD11	1.96	0.48
2:C1:173:ARG:HH12	2:C1:213:SER:HA	1.79	0.48
2:C4:28:LYS:NZ	2:C4:32:SER:OG	2.35	0.48
2:C4:94:LEU:HD21	2:C4:154:TYR:CE1	2.48	0.48
2:C5:35:ASP:OD2	2:C5:36:LEU:N	2.47	0.48
3:B3:47:THR:HA	3:B3:338:ILE:O	2.14	0.48
1:K2:44:LYS:HD2	1:K2:44:LYS:HA	1.64	0.47
1:K4:158:TYR:CE1	1:K5:181:PHE:HB3	2.49	0.47
1:K5:132:THR:HB	2:C5:128:ARG:HH21	1.79	0.47
2:C3:273:MET:O	2:C3:277:VAL:HG13	2.14	0.47
3:B5:200:VAL:CG1	3:B5:232:ILE:HG21	2.44	0.47
1:K3:167:GLU:HA	1:K3:170:GLN:NE2	2.28	0.47
2:C2:210:LEU:HD21	2:C2:259:PRO:HB2	1.95	0.47
2:C5:113:GLN:NE2	2:C5:140:TYR:OH	2.47	0.47
2:C5:363:ASP:HB3	2:C5:366:PHE:CE1	2.49	0.47
3:B2:26:ALA:HA	4:G2:30:VAL:HG23	1.95	0.47
3:B3:203:ALA:HB3	3:B3:205:ASP:OD1	2.14	0.47
1:K4:80:LEU:HD12	2:C4:55:GLU:HG2	1.96	0.47
1:K4:165:GLU:HB3	1:K4:201:PHE:HE2	1.80	0.47
2:C1:253:ASP:OD1	2:C1:256:THR:HG23	2.14	0.47
2:C4:80:VAL:HA	2:C4:83:GLU:OE2	2.15	0.47
2:C4:234:ILE:HD11	2:C4:276:ILE:HG21	1.96	0.47
3:B3:66:ASP:OD1	3:B3:66:ASP:N	2.46	0.47
1:K1:66:PRO:HA	1:K1:71:TYR:CD1	2.50	0.47
1:K5:221:SER:O	1:K5:225:LYS:HG2	2.14	0.47
2:C1:96:SER:O	2:C1:97:LEU:HD23	2.15	0.47
2:C1:188:GLN:O	2:C1:192:ILE:HG22	2.15	0.47
2:C1:212:MET:SD	2:C1:213:SER:N	2.87	0.47
3:B3:200:VAL:HG12	3:B3:234:PHE:CE1	2.49	0.47
2:C1:110:ASN:OD1	2:C1:111:ASP:N	2.47	0.47
2:C2:168:MET:SD	2:C2:183:ILE:HG12	2.54	0.47
2:C3:180:ARG:O	2:C3:184:ARG:HG2	2.14	0.47

*Continued on next page...*

*Continued from previous page...*

Atom-1	Atom-2	Interatomic distance (Å)	Clash overlap (Å)
2:C4:249:MET:HE2	2:C4:249:MET:N	2.30	0.47
3:B5:215:GLU:OE2	3:B5:217:MET:HG3	2.15	0.47
3:B5:309:ALA:HB3	3:B5:339:TRP:HH2	1.79	0.47
4:G1:48:ASP:HB3	4:G1:51:LEU:HD12	1.97	0.47
1:K2:133:SER:HA	2:C1:24:THR:HA	1.97	0.47
2:C1:65:VAL:HG12	2:C1:73:LEU:HD12	1.96	0.47
2:C1:110:ASN:O	2:C1:114:THR:HG22	2.15	0.47
2:C2:295:ASP:O	2:C2:299:MET:HG2	2.14	0.47
2:C5:25:MET:SD	2:C5:26:ASP:N	2.88	0.47
3:B1:69:LEU:HD22	3:B1:90:VAL:HG21	1.97	0.47
3:B1:70:LEU:HG	3:B1:82:TRP:HB2	1.96	0.47
3:B1:242:ALA:HA	3:B1:252:LEU:HA	1.95	0.47
3:B5:71:VAL:HG12	3:B5:81:ILE:HG12	1.97	0.47
4:G1:54:VAL:HB	4:G1:58:GLU:HG2	1.97	0.47
1:K3:150:SER:HB2	1:K4:210:HIS:ND1	2.29	0.47
2:C1:321:LEU:HD13	2:C1:352:PHE:CD2	2.50	0.47
2:C2:313:MET:HG3	2:C2:366:PHE:HZ	1.78	0.47
3:B1:19:ARG:O	3:B1:23:LYS:HE3	2.14	0.47
3:B1:38:ASP:O	3:B1:283:ARG:NH2	2.48	0.47
3:B1:54:HIS:ND1	3:B1:74:SER:HB3	2.30	0.47
3:B1:168:LEU:HB2	3:B1:180:PHE:HE2	1.79	0.47
3:B2:235:PHE:CG	3:B2:236:PRO:HD2	2.49	0.47
3:B3:148:CYS:O	3:B3:160:SER:OG	2.18	0.47
3:B4:57:LYS:HD3	3:B4:332:TRP:CG	2.49	0.47
3:B4:262:MET:SD	3:B4:302:ALA:HB2	2.54	0.47
3:B5:254:ASP:HB2	3:B5:261:LEU:HG	1.95	0.47
4:G3:54:VAL:O	4:G3:62:ARG:NH2	2.48	0.47
4:G4:1:MET:HG2	4:G4:4:ASN:HB2	1.95	0.47
4:G5:58:GLU:N	4:G5:58:GLU:OE1	2.48	0.47
2:C2:173:ARG:NE	2:C2:247:ARG:HH21	2.13	0.47
2:C2:374:PHE:HA	2:C2:377:PHE:CE1	2.50	0.47
2:C3:166:LEU:HA	2:C3:169:ILE:HG22	1.97	0.47
2:C5:241:ILE:O	2:C5:245:ILE:HG12	2.15	0.47
3:B2:57:LYS:HB3	3:B2:332:TRP:CD1	2.50	0.47
3:B2:230:ASN:ND2	3:B2:273:ILE:O	2.42	0.47
4:G2:11:GLN:HA	4:G2:14:LYS:HG3	1.97	0.47
1:K3:223:LYS:HD2	1:K3:226:ILE:HD12	1.97	0.47
2:C3:313:MET:HG2	2:C3:366:PHE:HE2	1.79	0.47
2:C5:169:ILE:HG12	2:C5:209:PHE:HE1	1.79	0.47
3:B1:143:THR:OG1	3:B1:163:ASP:HB3	2.15	0.47
3:B3:102:THR:HB	3:B3:148:CYS:HA	1.96	0.47

*Continued on next page...*

*Continued from previous page...*

Atom-1	Atom-2	Interatomic distance (Å)	Clash overlap (Å)
3:B3:182:GLY:O	3:B3:209:LYS:NZ	2.48	0.47
3:B4:16:ASN:HA	3:B4:19:ARG:HE	1.80	0.47
1:K4:93:ASP:HB2	2:C4:59:ARG:HH12	1.79	0.47
1:K5:66:PRO:O	1:K5:68:SER:N	2.48	0.47
1:K5:162:GLN:NE2	1:K5:199:ALA:HA	2.30	0.47
2:C2:173:ARG:HE	2:C2:247:ARG:HE	1.62	0.47
2:C4:212:MET:HA	2:C4:215:GLU:HG3	1.97	0.47
3:B4:79:LEU:HD12	3:B4:93:ILE:HD11	1.97	0.47
3:B4:288:GLY:HA2	3:B4:294:CYS:HB2	1.97	0.47
3:B5:200:VAL:HG21	3:B5:241:PHE:CZ	2.51	0.47
1:K5:179:TRP:CH2	3:B5:94:PRO:HB2	2.50	0.46
2:C1:120:ARG:NE	2:C1:139:VAL:HG23	2.27	0.46
2:C1:164:THR:O	2:C1:168:MET:HG2	2.16	0.46
2:C2:313:MET:O	2:C2:317:MET:HE2	2.15	0.46
2:C4:82:THR:O	2:C4:86:ILE:HG12	2.15	0.46
3:B1:145:TYR:O	3:B1:162:GLY:N	2.48	0.46
1:K1:98:TYR:CZ	1:K1:121:GLY:HA3	2.50	0.46
1:K2:98:TYR:CE2	1:K2:121:GLY:HA3	2.50	0.46
1:K3:132:THR:HA	1:K3:135:ILE:HG22	1.96	0.46
1:K5:123:LEU:O	1:K5:127:GLU:HG2	2.15	0.46
2:C1:153:ARG:NH1	2:C1:200:VAL:HG12	2.30	0.46
2:C1:245:ILE:O	2:C1:249:MET:HE2	2.15	0.46
2:C3:133:GLN:HE22	3:B4:141:GLY:C	2.18	0.46
2:C3:184:ARG:NH2	2:C3:188:GLN:OE1	2.49	0.46
3:B5:57:LYS:HB3	3:B5:332:TRP:CG	2.51	0.46
1:K2:104:ASN:HB3	1:K2:108:HIS:CE1	2.50	0.46
1:K3:223:LYS:HA	1:K3:226:ILE:HD12	1.97	0.46
2:C1:283:GLY:O	2:C1:287:MET:HE3	2.16	0.46
3:B2:7:LEU:HD13	4:G2:12:ALA:HB3	1.97	0.46
3:B4:76:ASP:O	3:B4:98:SER:OG	2.31	0.46
3:B5:53:GLY:H	3:B5:82:TRP:HH2	1.62	0.46
3:B5:254:ASP:HB3	3:B5:257:ALA:HB3	1.98	0.46
1:K1:107:ARG:HG2	2:C5:59:ARG:HH12	1.81	0.46
1:K4:119:GLU:CD	1:K4:119:GLU:H	2.19	0.46
3:B1:256:ARG:HH22	4:G1:33:ALA:HA	1.81	0.46
3:B3:18:ILE:HD12	4:G3:27:ARG:HH22	1.81	0.46
2:C4:151:VAL:HG13	2:C4:157:ILE:HD13	1.96	0.46
2:C4:261:VAL:O	2:C4:264:VAL:HB	2.14	0.46
2:C4:322:ARG:HA	2:C4:377:PHE:CE2	2.50	0.46
2:C5:274:LYS:O	2:C5:278:GLU:HG3	2.15	0.46
3:B1:79:LEU:HD21	3:B1:114:CYS:SG	2.55	0.46

*Continued on next page...*

*Continued from previous page...*

Atom-1	Atom-2	Interatomic distance (Å)	Clash overlap (Å)
3:B2:34:THR:O	3:B2:301:LYS:NZ	2.47	0.46
3:B4:101:MET:SD	3:B4:101:MET:N	2.89	0.46
4:G4:33:ALA:O	4:G4:37:LEU:HG	2.15	0.46
1:K2:195:ASN:O	1:K2:196:GLU:HB2	2.15	0.46
1:K4:105:TYR:CG	1:K4:134:LEU:HD13	2.51	0.46
2:C3:130:TYR:CZ	2:C3:136:VAL:HG21	2.51	0.46
3:B1:56:ALA:HB1	3:B1:75:GLN:HB3	1.97	0.46
2:C2:266:ARG:O	2:C2:270:SER:HB3	2.16	0.46
3:B2:5:ASP:O	3:B2:8:ARG:HG2	2.16	0.46
3:B3:252:LEU:O	3:B3:261:LEU:N	2.48	0.46
1:K4:72:ARG:HA	1:K4:72:ARG:HD2	1.66	0.46
1:K5:57:THR:HG21	1:K5:62:LEU:HD21	1.97	0.46
2:C2:180:ARG:HA	2:C2:183:ILE:HD12	1.98	0.46
2:C4:71:GLU:OE1	2:C4:71:GLU:N	2.44	0.46
2:C5:71:GLU:H	2:C5:71:GLU:CD	2.19	0.46
3:B1:63:TRP:NE1	3:B1:319:GLY:O	2.49	0.46
3:B1:203:ALA:HB3	3:B1:205:ASP:OD1	2.16	0.46
3:B2:118:ASP:OD1	3:B2:118:ASP:N	2.49	0.46
3:B3:297:TRP:HA	3:B3:304:ARG:HA	1.98	0.46
3:B4:54:HIS:CD2	3:B4:80:ILE:HD12	2.51	0.46
3:B5:79:LEU:HG	3:B5:95:LEU:HD11	1.98	0.46
3:B5:210:LEU:O	3:B5:219:ARG:N	2.49	0.46
1:K1:223:LYS:HA	1:K1:226:ILE:HG12	1.98	0.46
1:K5:104:ASN:HD22	1:K5:112:VAL:HG11	1.81	0.46
3:B1:30:LEU:O	3:B1:34:THR:HG22	2.16	0.46
3:B2:209:LYS:HD3	3:B2:211:TRP:CZ2	2.51	0.46
3:B4:252:LEU:O	3:B4:261:LEU:N	2.43	0.46
4:G1:13:ARG:O	4:G1:17:GLU:HG2	2.16	0.46
1:K5:108:HIS:O	1:K5:108:HIS:ND1	2.49	0.45
2:C3:30:VAL:O	2:C3:33:ILE:HG22	2.16	0.45
3:B1:128:THR:HG22	3:B1:130:GLU:H	1.81	0.45
3:B4:54:HIS:HE2	3:B4:82:TRP:HE1	1.64	0.45
3:B4:250:CYS:HB3	3:B4:264:TYR:HB2	1.98	0.45
1:K3:95:ASP:OD2	1:K3:97:THR:OG1	2.22	0.45
1:K5:106:LEU:HD12	1:K5:106:LEU:O	2.16	0.45
1:K5:132:THR:HG22	2:C5:128:ARG:HE	1.81	0.45
2:C1:245:ILE:O	2:C1:249:MET:HG2	2.17	0.45
2:C2:85:LEU:HD13	2:C2:147:PHE:HD1	1.80	0.45
3:B1:321:THR:HG23	3:B1:326:ALA:O	2.16	0.45
4:G4:41:CYS:SG	4:G4:42:GLU:N	2.89	0.45
1:K2:153:PRO:HG3	1:K3:180:LYS:HG3	1.98	0.45

*Continued on next page...*



*Continued from previous page...*

Atom-1	Atom-2	Interatomic distance (Å)	Clash overlap (Å)
1:K4:98:TYR:CZ	1:K4:121:GLY:HA3	2.51	0.45
2:C5:112:HIS:HE1	2:C5:144:LEU:HD12	1.82	0.45
2:C5:185:ASN:HA	2:C5:188:GLN:NE2	2.31	0.45
3:B1:143:THR:OG1	3:B1:162:GLY:O	2.35	0.45
3:B2:101:MET:SD	3:B2:116:GLY:HA2	2.56	0.45
4:G3:1:MET:H3	4:G3:7:ALA:HB2	1.81	0.45
2:C2:176:GLU:OE2	2:C2:176:GLU:N	2.50	0.45
2:C2:259:PRO:O	2:C2:263:VAL:HG23	2.17	0.45
2:C3:44:ILE:HG21	2:C3:118:MET:HE1	1.98	0.45
3:B1:286:LEU:HD12	3:B1:287:ALA:N	2.32	0.45
1:K5:218:SER:HA	3:B1:129:ARG:HB2	1.97	0.45
2:C2:208:PRO:HA	2:C2:211:GLU:HG3	1.98	0.45
2:C4:138:ASN:OD1	2:C4:141:ASN:ND2	2.50	0.45
3:B1:186:ASP:OD1	3:B1:186:ASP:N	2.46	0.45
3:B5:71:VAL:HG13	3:B5:105:TYR:CD2	2.51	0.45
1:K2:162:GLN:HE22	1:K2:199:ALA:HA	1.80	0.45
2:C2:186:ALA:HA	2:C2:189:MET:SD	2.57	0.45
2:C3:97:LEU:HD12	2:C3:97:LEU:O	2.16	0.45
2:C3:131:VAL:HG12	2:C3:136:VAL:HG23	1.99	0.45
3:B2:123:ILE:HG22	3:B2:137:ARG:HB2	1.98	0.45
3:B4:325:MET:HA	4:G4:49:PRO:HB2	1.97	0.45
1:K4:154:VAL:HA	1:K4:213:PRO:HG2	1.98	0.45
2:C1:152:VAL:HG21	2:C1:193:LEU:HD13	1.99	0.45
2:C4:210:LEU:HD21	2:C4:259:PRO:HB2	1.99	0.45
3:B2:293:ASN:HB2	3:B2:309:ALA:HA	1.99	0.45
3:B3:57:LYS:HD3	3:B3:332:TRP:CD2	2.51	0.45
2:C1:85:LEU:HD13	2:C1:150:GLN:HB2	1.98	0.45
2:C1:231:SER:O	2:C1:235:LYS:HG2	2.16	0.45
2:C3:248:VAL:HG13	2:C3:249:MET:SD	2.56	0.45
2:C4:260:ILE:O	2:C4:264:VAL:N	2.45	0.45
2:C4:317:MET:HE1	2:C4:352:PHE:CZ	2.51	0.45
2:C5:326:LYS:HZ2	2:C5:377:PHE:HB3	1.82	0.45
3:B1:155:ASN:HA	3:B1:171:ILE:HB	1.99	0.45
3:B3:278:PHE:HB3	3:B3:282:GLY:HA2	1.99	0.45
3:B5:235:PHE:CG	3:B5:236:PRO:HD2	2.52	0.45
2:C1:171:ARG:HA	2:C1:174:LYS:HD2	1.99	0.45
2:C1:202:GLU:HG3	2:C1:207:ALA:HB2	1.99	0.45
2:C1:277:VAL:O	2:C1:284:LEU:N	2.50	0.45
2:C5:33:ILE:HD11	2:C5:60:ASN:CG	2.37	0.45
3:B3:9:GLN:O	3:B3:13:GLN:HG2	2.17	0.45
3:B5:242:ALA:HB2	3:B5:278:PHE:CZ	2.52	0.45

*Continued on next page...*



*Continued from previous page...*

Atom-1	Atom-2	Interatomic distance (Å)	Clash overlap (Å)
2:C4:216:PHE:HA	2:C4:219:MET:SD	2.57	0.45
3:B3:155:ASN:OD1	3:B3:172:GLU:HG2	2.16	0.45
3:B3:168:LEU:HG	3:B3:177:THR:HB	1.98	0.45
3:B4:245:SER:OG	3:B4:246:ASP:N	2.50	0.45
3:B5:162:GLY:HA2	3:B5:186:ASP:OD1	2.16	0.45
3:B5:297:TRP:CE3	3:B5:304:ARG:HA	2.52	0.45
1:K2:179:TRP:CH2	3:B2:94:PRO:HB2	2.51	0.44
1:K2:194:GLY:HA3	1:K2:200:GLU:CD	2.37	0.44
1:K4:121:GLY:O	1:K4:124:GLU:HG3	2.17	0.44
2:C3:225:LEU:HD13	2:C3:275:THR:HG21	1.99	0.44
3:B1:189:SER:HB2	3:B1:230:ASN:O	2.17	0.44
3:B3:121:CYS:HB3	3:B3:139:LEU:HB2	1.98	0.44
3:B4:203:ALA:HB3	3:B4:205:ASP:OD1	2.17	0.44
1:K1:98:TYR:HE1	1:K1:117:LEU:HB3	1.82	0.44
1:K2:211:ASN:O	1:K2:215:GLY:N	2.50	0.44
1:K1:159:ARG:NH2	3:B1:97:SER:O	2.50	0.44
1:K2:107:ARG:O	2:C1:59:ARG:NE	2.50	0.44
1:K4:110:LYS:HD2	1:K4:110:LYS:HA	1.83	0.44
2:C2:313:MET:HG3	2:C2:366:PHE:CZ	2.52	0.44
3:B4:266:HIS:HD2	3:B4:267:ASP:N	2.15	0.44
1:K3:169:THR:O	1:K3:173:SER:OG	2.26	0.44
2:C2:167:ASP:OD1	2:C2:168:MET:N	2.51	0.44
2:C2:313:MET:O	2:C2:317:MET:HG2	2.18	0.44
2:C4:324:GLN:O	2:C4:328:LEU:HG	2.17	0.44
3:B1:42:ARG:HA	3:B1:42:ARG:NH1	2.33	0.44
3:B1:182:GLY:O	3:B1:209:LYS:HE3	2.18	0.44
3:B5:197:ARG:O	3:B5:198:LEU:HD13	2.17	0.44
4:G3:17:GLU:O	4:G3:20:LYS:HB2	2.18	0.44
1:K3:83:ASP:N	1:K3:90:TYR:HD1	2.16	0.44
1:K5:81:ASP:HB3	2:C5:53:SER:HB2	2.00	0.44
2:C1:92:ASP:HA	2:C1:95:ASN:ND2	2.32	0.44
2:C4:100:ASN:HD22	2:C4:103:GLN:HB2	1.82	0.44
2:C4:261:VAL:HA	2:C4:264:VAL:HB	1.99	0.44
3:B3:14:LEU:O	3:B3:18:ILE:HG12	2.17	0.44
2:C1:100:ASN:HB2	2:C1:103:GLN:HB3	1.98	0.44
2:C5:127:ASP:O	2:C5:132:GLN:NE2	2.50	0.44
3:B4:213:VAL:HG22	3:B4:214:ARG:NH1	2.32	0.44
3:B5:252:LEU:O	3:B5:261:LEU:N	2.51	0.44
1:K4:107:ARG:HA	2:C3:59:ARG:HH12	1.83	0.44
2:C3:230:ALA:O	2:C3:234:ILE:HG12	2.17	0.44
2:C4:166:LEU:HD22	2:C4:212:MET:HG2	1.98	0.44

*Continued on next page...*

*Continued from previous page...*

Atom-1	Atom-2	Interatomic distance (Å)	Clash overlap (Å)
2:C5:166:LEU:O	2:C5:169:ILE:HG22	2.18	0.44
2:C5:266:ARG:HG3	2:C5:267:GLU:OE2	2.18	0.44
3:B1:22:ARG:NH2	4:G1:22:GLU:OE2	2.50	0.44
3:B1:51:LEU:HB3	3:B1:82:TRP:CE3	2.53	0.44
3:B2:124:TYR:HE2	3:B2:135:VAL:HG23	1.82	0.44
3:B2:325:MET:HE1	4:G2:60:PRO:HD2	1.99	0.44
3:B4:59:TYR:CE1	3:B4:101:MET:HB3	2.53	0.44
1:K3:219:GLU:OE2	3:B4:129:ARG:HG3	2.18	0.44
2:C4:102:LEU:HD22	2:C4:182:ALA:HB1	2.00	0.44
2:C4:184:ARG:NH1	2:C4:184:ARG:HA	2.33	0.44
3:B2:48:ARG:HB3	4:G2:62:ARG:HB2	1.98	0.44
3:B3:222:PHE:HB3	3:B3:253:PHE:CD1	2.52	0.44
3:B4:123:ILE:O	3:B4:136:SER:OG	2.31	0.44
3:B5:235:PHE:CD1	3:B5:236:PRO:HD2	2.53	0.44
3:B5:315:VAL:HA	3:B5:331:SER:HA	2.00	0.44
1:K1:44:LYS:HA	1:K1:44:LYS:HD2	1.80	0.44
1:K1:50:VAL:HA	1:K1:92:ILE:HG23	2.00	0.44
1:K3:106:LEU:HD23	1:K3:106:LEU:HA	1.78	0.44
2:C2:61:ALA:O	2:C2:65:VAL:HG23	2.18	0.44
2:C2:89:VAL:O	2:C2:93:VAL:HG23	2.18	0.44
2:C2:187:CYS:SG	2:C2:252:LEU:HA	2.58	0.44
2:C2:243:GLU:O	2:C2:247:ARG:NH1	2.51	0.44
2:C4:109:TRP:CE3	2:C4:189:MET:HG2	2.53	0.44
3:B1:225:HIS:CE1	3:B1:251:ARG:HG3	2.53	0.44
3:B2:137:ARG:NH1	3:B2:138:GLU:H	2.16	0.44
3:B2:289:TYR:HB3	3:B2:291:ASP:H	1.83	0.44
3:B3:296:VAL:O	3:B3:305:ALA:N	2.50	0.44
1:K3:185:VAL:HG21	1:K4:184:LEU:HD23	1.99	0.43
1:K5:94:ARG:HH12	1:K5:125:GLU:HA	1.81	0.43
2:C3:123:LEU:HB3	2:C3:126:MET:HG3	2.00	0.43
3:B2:57:LYS:HD3	3:B2:332:TRP:CD2	2.53	0.43
3:B3:256:ARG:NH2	4:G3:33:ALA:HA	2.33	0.43
3:B5:105:TYR:CE1	3:B5:109:GLY:HA2	2.47	0.43
3:B5:254:ASP:HB2	3:B5:261:LEU:CG	2.48	0.43
3:B1:57:LYS:O	3:B1:75:GLN:N	2.51	0.43
3:B4:79:LEU:HB2	3:B4:93:ILE:HG12	1.99	0.43
3:B5:197:ARG:HB3	3:B5:214:ARG:HD2	2.00	0.43
1:K1:105:TYR:CD1	1:K1:134:LEU:HD13	2.54	0.43
1:K3:81:ASP:OD1	1:K3:81:ASP:N	2.50	0.43
1:K5:123:LEU:HA	1:K5:138:VAL:HG11	1.99	0.43
2:C1:287:MET:HE3	2:C1:287:MET:H	1.83	0.43

*Continued on next page...*

*Continued from previous page...*

Atom-1	Atom-2	Interatomic distance (Å)	Clash overlap (Å)
3:B4:4:LEU:HG	3:B4:8:ARG:HH12	1.82	0.43
3:B5:82:TRP:CD1	3:B5:82:TRP:N	2.86	0.43
4:G2:17:GLU:O	4:G2:21:MET:HE3	2.17	0.43
2:C1:90:ARG:NH2	2:C1:150:GLN:O	2.38	0.43
2:C2:34:TRP:CH2	2:C2:72:LYS:HB3	2.53	0.43
3:B3:199:PHE:HD1	3:B3:213:VAL:HG12	1.83	0.43
3:B3:321:THR:OG1	3:B3:325:MET:N	2.51	0.43
4:G2:22:GLU:O	4:G2:27:ARG:NH2	2.52	0.43
1:K4:64:ARG:NH2	1:K4:106:LEU:HA	2.26	0.43
2:C1:60:ASN:O	2:C1:64:MET:HB2	2.19	0.43
2:C2:286:HIS:HA	2:C2:289:LYS:HE3	2.00	0.43
2:C4:85:LEU:HG	2:C4:89:VAL:HB	1.99	0.43
2:C5:90:ARG:HH21	2:C5:157:ILE:CD1	2.25	0.43
3:B5:283:ARG:HH21	3:B5:301:LYS:NZ	2.16	0.43
2:C2:278:GLU:OE1	2:C2:286:HIS:NE2	2.52	0.43
3:B2:285:LEU:O	3:B2:296:VAL:HA	2.18	0.43
3:B2:292:PHE:HE1	3:B2:313:ASN:HA	1.84	0.43
3:B3:121:CYS:HB2	3:B3:146:LEU:HD21	2.00	0.43
3:B3:230:ASN:ND2	3:B3:273:ILE:O	2.44	0.43
3:B3:327:VAL:HG13	3:B3:339:TRP:HB2	2.00	0.43
3:B4:266:HIS:HB3	3:B4:269:ILE:HG12	2.01	0.43
3:B5:56:ALA:HB1	3:B5:75:GLN:HE22	1.83	0.43
1:K1:233:ARG:HH12	3:B2:85:TYR:HB2	1.83	0.43
2:C3:73:LEU:HD23	2:C3:73:LEU:HA	1.84	0.43
2:C4:321:LEU:HD13	2:C4:352:PHE:CE2	2.53	0.43
3:B3:212:ASP:OD1	3:B3:214:ARG:NH2	2.50	0.43
3:B4:162:GLY:HA2	3:B4:186:ASP:OD1	2.18	0.43
3:B5:127:LYS:HA	3:B5:127:LYS:HD3	1.89	0.43
4:G4:45:ALA:HB3	4:G4:46:LYS:HZ2	1.84	0.43
1:K1:233:ARG:HD3	3:B2:68:ARG:CZ	2.49	0.43
1:K5:210:HIS:O	1:K5:213:PRO:HD2	2.19	0.43
2:C1:287:MET:HA	2:C1:290:ASN:HB2	2.01	0.43
2:C4:248:VAL:HA	2:C4:252:LEU:HB2	2.00	0.43
3:B1:106:ALA:HB2	3:B1:111:TYR:HB2	2.00	0.43
3:B2:123:ILE:O	3:B2:136:SER:OG	2.27	0.43
3:B3:49:ARG:HB2	3:B3:338:ILE:HB	2.01	0.43
3:B3:121:CYS:HB3	3:B3:139:LEU:HD12	2.01	0.43
3:B5:284:LEU:HD21	4:G5:51:LEU:HG	2.01	0.43
2:C3:266:ARG:HD2	2:C3:270:SER:OG	2.19	0.43
2:C4:287:MET:HE2	2:C4:287:MET:HA	2.00	0.43
3:B1:178:THR:O	3:B1:178:THR:OG1	2.34	0.43

*Continued on next page...*

*Continued from previous page...*

Atom-1	Atom-2	Interatomic distance (Å)	Clash overlap (Å)
3:B2:27:ASP:H	4:G2:30:VAL:HB	1.84	0.43
3:B4:189:SER:OG	3:B4:231:ALA:HA	2.18	0.43
3:B4:228:ASP:OD1	3:B4:228:ASP:N	2.52	0.43
1:K1:155:LYS:HD3	1:K1:211:ASN:HB3	2.00	0.43
2:C2:209:PHE:HA	2:C2:212:MET:HG3	2.01	0.43
2:C2:344:GLY:HA2	2:C2:347:ASP:HB2	2.01	0.43
2:C3:159:ASP:OD2	2:C3:159:ASP:N	2.51	0.43
2:C3:173:ARG:NH2	2:C3:213:SER:OG	2.50	0.43
2:C5:234:ILE:HG13	2:C5:299:MET:CE	2.49	0.43
3:B1:222:PHE:HB3	3:B1:253:PHE:CD1	2.52	0.43
3:B2:61:MET:HB2	3:B2:61:MET:HE3	1.55	0.43
3:B2:294:CYS:SG	3:B2:308:LEU:HB2	2.59	0.43
2:C3:248:VAL:HB	2:C3:260:ILE:HD11	2.01	0.42
2:C4:138:ASN:O	2:C4:142:LEU:HB2	2.18	0.42
2:C5:320:TYR:O	2:C5:323:GLU:HG2	2.19	0.42
3:B2:124:TYR:CE2	3:B2:135:VAL:HG23	2.55	0.42
3:B5:5:ASP:O	3:B5:8:ARG:HG2	2.18	0.42
1:K2:61:THR:CG2	1:K2:107:ARG:HE	2.32	0.42
2:C3:258:GLU:HG2	2:C3:259:PRO:HD3	1.99	0.42
2:C4:85:LEU:HD22	2:C4:150:GLN:HB3	2.01	0.42
3:B5:72:SER:HB3	3:B5:336:LEU:HD21	2.01	0.42
3:B5:233:CYS:SG	3:B5:277:SER:HA	2.59	0.42
4:G3:5:ASN:OD1	4:G3:5:ASN:O	2.36	0.42
1:K4:128:PHE:HA	2:C4:62:TYR:CZ	2.55	0.42
1:K4:140:ASP:OD1	1:K4:143:ARG:NH2	2.53	0.42
2:C1:276:ILE:HD12	2:C1:303:PHE:CE2	2.54	0.42
3:B2:198:LEU:HD13	3:B2:211:TRP:O	2.20	0.42
3:B4:183:HIS:CE1	3:B4:209:LYS:HG3	2.54	0.42
4:G2:14:LYS:HD2	4:G2:15:LEU:N	2.33	0.42
1:K2:54:TYR:OH	1:K2:84:LYS:HD2	2.19	0.42
1:K3:209:LEU:HD22	1:K3:214:TYR:HE2	1.84	0.42
1:K5:50:VAL:HG13	1:K5:94:ARG:O	2.20	0.42
2:C1:273:MET:HA	2:C1:303:PHE:CZ	2.54	0.42
2:C4:77:LEU:HD22	2:C4:123:LEU:HD22	2.01	0.42
2:C4:300:TYR:HD2	2:C4:301:LYS:HZ2	1.68	0.42
3:B2:262:MET:SD	3:B2:302:ALA:HB2	2.59	0.42
3:B4:331:SER:HB2	3:B4:333:ASP:OD1	2.19	0.42
3:B5:197:ARG:O	3:B5:213:VAL:HG22	2.19	0.42
3:B5:309:ALA:HB3	3:B5:339:TRP:CH2	2.54	0.42
4:G2:59:ASN:ND2	4:G2:62:ARG:O	2.53	0.42
1:K1:97:THR:OG1	1:K1:98:TYR:N	2.51	0.42

*Continued on next page...*

*Continued from previous page...*

Atom-1	Atom-2	Interatomic distance (Å)	Clash overlap (Å)
1:K2:134:LEU:O	1:K2:138:VAL:HG23	2.19	0.42
2:C1:270:SER:HB2	2:C1:306:VAL:HG21	2.00	0.42
2:C2:168:MET:HA	2:C2:171:ARG:HE	1.84	0.42
2:C5:100:ASN:O	2:C5:100:ASN:ND2	2.52	0.42
3:B2:42:ARG:NH1	3:B2:306:GLY:HA2	2.34	0.42
3:B2:51:LEU:HB3	3:B2:82:TRP:CE2	2.54	0.42
3:B3:63:TRP:NE1	3:B3:319:GLY:O	2.48	0.42
3:B3:261:LEU:HD12	3:B3:261:LEU:HA	1.92	0.42
3:B4:277:SER:OG	3:B4:286:LEU:HB2	2.19	0.42
3:B5:60:ALA:HB2	3:B5:101:MET:O	2.20	0.42
3:B5:74:SER:OG	3:B5:76:ASP:OD2	2.27	0.42
4:G1:22:GLU:O	4:G1:27:ARG:NH2	2.53	0.42
1:K1:116:ASP:O	1:K2:114:ASN:HB3	2.19	0.42
2:C1:217:PHE:CZ	2:C1:264:VAL:HG22	2.55	0.42
2:C1:219:MET:SD	2:C1:220:GLU:N	2.92	0.42
2:C2:62:TYR:O	2:C2:66:LEU:HG	2.19	0.42
2:C2:356:LEU:HA	2:C2:360:PHE:HB2	2.00	0.42
2:C3:241:ILE:O	2:C3:245:ILE:HG12	2.20	0.42
2:C4:29:TYR:O	2:C4:33:ILE:HG22	2.20	0.42
2:C4:33:ILE:HD11	2:C4:60:ASN:ND2	2.34	0.42
2:C4:253:ASP:HB2	2:C4:256:THR:HG23	2.02	0.42
2:C5:45:GLN:HB3	2:C5:84:HIS:CD2	2.54	0.42
2:C5:360:PHE:HD2	2:C5:366:PHE:CD1	2.37	0.42
3:B3:193:ALA:HB2	3:B3:234:PHE:CE2	2.55	0.42
1:K5:130:ASN:OD1	1:K5:130:ASN:O	2.38	0.42
3:B4:10:GLU:O	3:B4:13:GLN:HG3	2.19	0.42
4:G1:11:GLN:O	4:G1:15:LEU:HG	2.19	0.42
2:C3:233:TYR:HA	2:C3:236:LYS:HZ3	1.85	0.42
4:G3:1:MET:N	4:G3:7:ALA:HB2	2.35	0.42
2:C1:373:ASP:HB3	2:C1:377:PHE:CE2	2.53	0.42
2:C2:231:SER:HB3	2:C2:295:ASP:OD2	2.18	0.42
3:B2:142:HIS:NE2	3:B2:159:THR:OG1	2.41	0.42
3:B5:54:HIS:ND1	3:B5:78:LYS:HE3	2.34	0.42
1:K3:171:MET:SD	1:K3:172:VAL:HG23	2.60	0.42
1:K5:94:ARG:NH1	1:K5:125:GLU:HA	2.35	0.42
2:C3:120:ARG:HD3	2:C3:140:TYR:CD2	2.55	0.42
2:C4:64:MET:CE	2:C4:73:LEU:HD21	2.50	0.42
2:C5:218:GLN:HG2	2:C5:267:GLU:OE1	2.20	0.42
3:B1:166:CYS:SG	3:B1:187:VAL:HG11	2.60	0.42
3:B2:3:GLU:OE1	3:B2:6:GLN:HB3	2.20	0.42
3:B5:130:GLU:OE1	3:B5:134:ARG:NH1	2.52	0.42

*Continued on next page...*

*Continued from previous page...*

Atom-1	Atom-2	Interatomic distance (Å)	Clash overlap (Å)
4:G3:17:GLU:O	4:G3:21:MET:SD	2.78	0.42
1:K1:181:PHE:HZ	1:K1:184:LEU:HB2	1.84	0.41
1:K4:110:LYS:HD2	1:K4:137:LEU:HD21	2.02	0.41
1:K4:165:GLU:O	1:K4:168:LEU:HB2	2.20	0.41
2:C5:53:SER:HB3	2:C5:56:GLU:HG3	2.01	0.41
2:C5:78:ARG:O	2:C5:82:THR:OG1	2.33	0.41
3:B1:199:PHE:CD2	3:B1:213:VAL:HG12	2.49	0.41
3:B3:68:ARG:HD2	3:B3:85:TYR:CD2	2.55	0.41
3:B5:51:LEU:HD23	3:B5:82:TRP:CD2	2.54	0.41
3:B5:146:LEU:HD13	3:B5:161:SER:HB3	2.02	0.41
3:B5:286:LEU:HD12	3:B5:286:LEU:H	1.84	0.41
1:K1:168:LEU:HD11	1:K1:184:LEU:HD21	2.02	0.41
1:K2:176:SER:HB2	1:K2:179:TRP:CD1	2.55	0.41
2:C1:62:TYR:O	2:C1:66:LEU:HG	2.20	0.41
2:C3:123:LEU:HB2	2:C3:139:VAL:HG21	2.02	0.41
2:C3:172:GLU:HB3	2:C3:247:ARG:HH12	1.84	0.41
2:C3:287:MET:HA	2:C3:292:LYS:NZ	2.35	0.41
3:B1:84:SER:HB2	4:G1:61:PHE:HE1	1.85	0.41
3:B1:153:ASP:HB3	3:B1:156:GLN:HB2	2.02	0.41
3:B1:156:GLN:HA	3:B1:156:GLN:OE1	2.19	0.41
3:B1:313:ASN:OD1	3:B1:314:ARG:N	2.46	0.41
3:B2:14:LEU:HD11	4:G2:20:LYS:HZ2	1.85	0.41
3:B2:42:ARG:CZ	3:B2:306:GLY:HA2	2.50	0.41
1:K1:226:ILE:O	1:K1:230:ARG:HG3	2.20	0.41
2:C1:152:VAL:O	2:C1:158:ARG:HB2	2.20	0.41
2:C2:259:PRO:O	2:C2:262:LYS:HG2	2.20	0.41
2:C3:64:MET:HG3	2:C3:64:MET:H	1.64	0.41
2:C4:100:ASN:O	2:C4:104:THR:HG23	2.21	0.41
2:C4:302:LEU:HD12	2:C4:305:ARG:HH11	1.85	0.41
3:B1:3:GLU:HB3	4:G1:9:ILE:HG21	2.02	0.41
3:B1:4:LEU:O	3:B1:8:ARG:HG2	2.20	0.41
3:B4:286:LEU:HD12	3:B4:286:LEU:H	1.85	0.41
1:K2:84:LYS:HZ3	1:K2:89:ALA:HB3	1.84	0.41
2:C2:164:THR:HA	2:C2:167:ASP:OD2	2.19	0.41
2:C4:116:MET:HG3	2:C4:140:TYR:CE1	2.56	0.41
2:C4:234:ILE:HG13	2:C4:299:MET:SD	2.60	0.41
2:C5:276:ILE:HA	2:C5:279:MET:CE	2.50	0.41
3:B1:148:CYS:O	3:B1:160:SER:OG	2.27	0.41
3:B5:298:ASP:HB3	3:B5:301:LYS:HB2	2.02	0.41
3:B5:321:THR:OG1	3:B5:325:MET:N	2.53	0.41
1:K5:94:ARG:NH2	1:K5:125:GLU:OE1	2.54	0.41

*Continued on next page...*



*Continued from previous page...*

Atom-1	Atom-2	Interatomic distance (Å)	Clash overlap (Å)
2:C1:184:ARG:O	2:C1:188:GLN:HG3	2.21	0.41
2:C2:293:THR:HG23	2:C2:355:PHE:HD1	1.86	0.41
2:C5:121:ASP:HA	2:C5:124:MET:SD	2.61	0.41
3:B1:286:LEU:HD23	3:B1:327:VAL:HG21	2.01	0.41
3:B4:59:TYR:CD1	3:B4:101:MET:HB3	2.56	0.41
1:K2:182:GLU:HG3	1:K2:206:SER:HB3	2.02	0.41
2:C1:287:MET:HG3	2:C1:295:ASP:HB2	2.03	0.41
2:C2:109:TRP:CE2	2:C2:189:MET:HE2	2.56	0.41
2:C2:322:ARG:O	2:C2:326:LYS:HG2	2.20	0.41
3:B1:90:VAL:HG12	3:B1:91:HIS:ND1	2.36	0.41
3:B2:147:SER:CB	3:B2:188:MET:HA	2.51	0.41
3:B2:292:PHE:CE1	3:B2:313:ASN:HA	2.56	0.41
3:B4:37:ILE:HD13	4:G4:38:MET:SD	2.61	0.41
3:B4:245:SER:HB3	3:B4:247:ASP:OD1	2.21	0.41
4:G5:5:ASN:OD1	4:G5:5:ASN:O	2.38	0.41
4:G5:14:LYS:HA	4:G5:17:GLU:OE1	2.21	0.41
1:K5:67:LYS:O	1:K5:67:LYS:HG2	2.21	0.41
2:C1:212:MET:HA	2:C1:215:GLU:HG3	2.02	0.41
2:C2:116:MET:HE2	2:C2:140:TYR:HA	2.03	0.41
2:C5:243:GLU:HA	2:C5:246:GLU:HG2	2.03	0.41
3:B3:57:LYS:O	3:B3:75:GLN:N	2.52	0.41
3:B5:79:LEU:HD23	3:B5:79:LEU:HA	1.84	0.41
3:B5:226:GLU:CD	3:B5:226:GLU:H	2.24	0.41
1:K1:221:SER:O	1:K1:225:LYS:HG2	2.21	0.41
2:C1:71:GLU:OE2	2:C1:71:GLU:N	2.38	0.41
2:C2:286:HIS:O	2:C2:289:LYS:HG2	2.21	0.41
3:B1:29:THR:HG21	3:B1:262:MET:SD	2.60	0.41
3:B3:29:THR:O	3:B3:33:ILE:HG13	2.20	0.41
3:B4:79:LEU:HG	3:B4:95:LEU:HD21	2.02	0.41
3:B5:51:LEU:HD23	3:B5:82:TRP:CE3	2.55	0.41
3:B5:325:MET:CE	4:G5:59:ASN:HB3	2.51	0.41
1:K1:99:PHE:CZ	1:K1:103:LEU:HD22	2.55	0.41
1:K2:133:SER:HB3	2:C1:25:MET:SD	2.60	0.41
1:K3:127:GLU:OE1	1:K3:135:ILE:HD13	2.21	0.41
1:K5:67:LYS:HE2	1:K5:67:LYS:HB3	1.77	0.41
1:K5:179:TRP:NE1	1:K5:207:LYS:HD2	2.36	0.41
2:C1:125:TYR:HD1	2:C1:128:ARG:HG3	1.85	0.41
2:C1:238:GLU:HG2	2:C1:302:LEU:HD13	2.03	0.41
2:C1:248:VAL:HG21	2:C1:260:ILE:HG21	2.03	0.41
2:C1:366:PHE:O	2:C1:370:ILE:HG23	2.20	0.41
2:C2:188:GLN:O	2:C2:192:ILE:HG12	2.21	0.41

*Continued on next page...*

*Continued from previous page...*

Atom-1	Atom-2	Interatomic distance (Å)	Clash overlap (Å)
2:C2:317:MET:HB3	2:C2:352:PHE:HE2	1.85	0.41
2:C4:45:GLN:HE22	2:C4:80:VAL:HG12	1.85	0.41
2:C4:277:VAL:HG12	2:C4:278:GLU:HG2	2.01	0.41
2:C5:169:ILE:HG12	2:C5:209:PHE:CE1	2.56	0.41
3:B1:226:GLU:OE1	3:B1:226:GLU:N	2.40	0.41
3:B2:183:HIS:HE1	3:B2:207:SER:O	2.04	0.41
3:B2:283:ARG:HH22	3:B2:301:LYS:HE2	1.85	0.41
3:B3:5:ASP:HA	3:B3:8:ARG:HG2	2.03	0.41
3:B3:6:GLN:HG3	3:B3:7:LEU:HD23	2.03	0.41
3:B3:262:MET:HE2	3:B3:262:MET:HB2	1.89	0.41
3:B4:214:ARG:HB2	3:B4:215:GLU:OE1	2.21	0.41
3:B4:233:CYS:SG	3:B4:277:SER:HA	2.61	0.41
3:B4:294:CYS:SG	3:B4:308:LEU:HB2	2.61	0.41
4:G2:20:LYS:HB2	4:G2:21:MET:HE2	2.00	0.41
1:K4:119:GLU:HA	1:K4:122:VAL:HG12	2.02	0.41
2:C1:109:TRP:HZ3	2:C1:112:HIS:HD1	1.68	0.41
2:C2:169:ILE:HG21	2:C2:209:PHE:CE1	2.54	0.41
2:C3:168:MET:HA	2:C3:171:ARG:HG2	2.03	0.41
2:C3:230:ALA:HB3	2:C3:287:MET:HE1	2.02	0.41
2:C5:310:LEU:HA	2:C5:313:MET:HG2	2.02	0.41
3:B3:318:LEU:HD21	3:B3:329:THR:HG22	2.03	0.41
3:B4:31:SER:HB2	3:B4:300:LEU:O	2.22	0.41
3:B4:54:HIS:NE2	3:B4:80:ILE:HD12	2.35	0.41
3:B5:262:MET:HG3	3:B5:263:THR:N	2.35	0.41
1:K2:77:ASP:OD1	1:K2:77:ASP:N	2.53	0.40
1:K2:133:SER:HB3	2:C1:25:MET:H	1.86	0.40
1:K3:123:LEU:HB2	1:K3:138:VAL:HG11	2.03	0.40
1:K4:148:LYS:HB2	1:K4:213:PRO:HB3	2.03	0.40
1:K4:157:VAL:HB	1:K4:209:LEU:HD11	2.03	0.40
2:C1:258:GLU:HB3	2:C1:259:PRO:HD3	2.02	0.40
2:C5:234:ILE:HG23	2:C5:302:LEU:HD22	2.04	0.40
3:B2:277:SER:OG	3:B2:286:LEU:HB2	2.20	0.40
3:B4:287:ALA:O	3:B4:294:CYS:HB2	2.21	0.40
3:B5:245:SER:OG	3:B5:246:ASP:N	2.54	0.40
1:K1:133:SER:O	1:K1:137:LEU:HG	2.21	0.40
1:K1:209:LEU:HD21	3:B1:96:ARG:HG3	2.03	0.40
1:K5:58:THR:HB	1:K5:61:THR:HG23	2.04	0.40
2:C1:221:SER:HB3	2:C1:268:LEU:HD23	2.04	0.40
2:C3:188:GLN:HA	2:C3:191:MET:SD	2.61	0.40
2:C4:116:MET:HE1	2:C4:139:VAL:O	2.22	0.40
2:C5:116:MET:HE3	2:C5:139:VAL:HG12	2.02	0.40

*Continued on next page...*



*Continued from previous page...*

Atom-1	Atom-2	Interatomic distance (Å)	Clash overlap (Å)
3:B2:77:GLY:O	3:B2:95:LEU:HB2	2.21	0.40
3:B2:90:VAL:HG12	3:B2:91:HIS:CE1	2.56	0.40
3:B4:102:THR:O	3:B4:114:CYS:HA	2.21	0.40
3:B5:228:ASP:OD1	3:B5:228:ASP:N	2.53	0.40
4:G1:38:MET:O	4:G1:42:GLU:HG2	2.21	0.40
1:K1:179:TRP:CH2	3:B1:94:PRO:HB2	2.57	0.40
1:K4:151:GLN:O	1:K5:208:GLU:HB2	2.20	0.40
2:C2:171:ARG:HA	2:C2:174:LYS:HE2	2.02	0.40
2:C5:314:CYS:HG	2:C5:366:PHE:HD2	1.69	0.40
3:B2:22:ARG:O	3:B2:26:ALA:N	2.54	0.40
3:B5:51:LEU:HB3	3:B5:82:TRP:CZ3	2.56	0.40
4:G4:18:GLN:HE21	4:G4:22:GLU:HG3	1.85	0.40
1:K1:175:MET:SD	1:K1:179:TRP:HB2	2.60	0.40
1:K5:103:LEU:O	1:K5:107:ARG:HD3	2.21	0.40
2:C1:352:PHE:N	2:C1:352:PHE:CD1	2.90	0.40
2:C4:100:ASN:ND2	2:C4:103:GLN:HB2	2.37	0.40
2:C4:250:HIS:CD2	2:C4:250:HIS:N	2.88	0.40
2:C5:160:HIS:O	2:C5:163:GLN:NE2	2.54	0.40
2:C5:300:TYR:HE1	2:C5:310:LEU:HD22	1.85	0.40
3:B2:295:ASN:ND2	3:B2:304:ARG:HG3	2.33	0.40
3:B4:60:ALA:HB2	3:B4:101:MET:O	2.21	0.40
3:B4:89:LYS:HD2	3:B4:89:LYS:N	2.36	0.40
3:B5:53:GLY:N	3:B5:82:TRP:HH2	2.20	0.40
3:B5:213:VAL:CG2	3:B5:214:ARG:HD3	2.51	0.40
4:G2:29:LYS:HA	4:G2:29:LYS:HD3	1.84	0.40
4:G3:59:ASN:HD21	4:G3:62:ARG:HG3	1.86	0.40
1:K2:147:SER:O	1:K2:151:GLN:N	2.52	0.40
1:K4:49:ASN:HB2	1:K4:91:LEU:HA	2.03	0.40
2:C4:94:LEU:HA	2:C4:97:LEU:HD21	2.04	0.40
3:B1:32:GLN:NE2	3:B1:33:ILE:HG12	2.37	0.40
3:B2:197:ARG:O	3:B2:198:LEU:HD22	2.20	0.40
3:B3:222:PHE:CE2	3:B3:258:ASP:HA	2.55	0.40
3:B3:308:LEU:HD23	3:B3:308:LEU:HA	1.95	0.40
3:B5:189:SER:HB2	3:B5:230:ASN:O	2.22	0.40

There are no symmetry-related clashes.

## 5.3 Torsion angles [i](#)

### 5.3.1 Protein backbone [i](#)

In the following table, the Percentiles column shows the percent Ramachandran outliers of the chain as a percentile score with respect to all PDB entries followed by that with respect to all EM entries.

The Analysed column shows the number of residues for which the backbone conformation was analysed, and the total number of residues.

Mol	Chain	Analysed	Favoured	Allowed	Outliers	Percentiles	
1	K1	192/233 (82%)	185 (96%)	7 (4%)	0	100	100
1	K2	192/233 (82%)	178 (93%)	13 (7%)	1 (0%)	29	66
1	K3	192/233 (82%)	186 (97%)	5 (3%)	1 (0%)	29	66
1	K4	192/233 (82%)	177 (92%)	15 (8%)	0	100	100
1	K5	192/233 (82%)	180 (94%)	10 (5%)	2 (1%)	15	52
2	C1	356/381 (93%)	342 (96%)	14 (4%)	0	100	100
2	C2	356/381 (93%)	339 (95%)	17 (5%)	0	100	100
2	C3	356/381 (93%)	347 (98%)	9 (2%)	0	100	100
2	C4	356/381 (93%)	343 (96%)	13 (4%)	0	100	100
2	C5	356/381 (93%)	341 (96%)	15 (4%)	0	100	100
3	B1	337/340 (99%)	319 (95%)	18 (5%)	0	100	100
3	B2	337/340 (99%)	313 (93%)	24 (7%)	0	100	100
3	B3	337/340 (99%)	317 (94%)	19 (6%)	1 (0%)	41	74
3	B4	337/340 (99%)	317 (94%)	20 (6%)	0	100	100
3	B5	337/340 (99%)	320 (95%)	17 (5%)	0	100	100
4	G1	61/71 (86%)	57 (93%)	4 (7%)	0	100	100
4	G2	61/71 (86%)	57 (93%)	3 (5%)	1 (2%)	9	44
4	G3	61/71 (86%)	58 (95%)	3 (5%)	0	100	100
4	G4	61/71 (86%)	56 (92%)	5 (8%)	0	100	100
4	G5	61/71 (86%)	57 (93%)	4 (7%)	0	100	100
All	All	4730/5125 (92%)	4489 (95%)	235 (5%)	6 (0%)	54	83

All (6) Ramachandran outliers are listed below:

Mol	Chain	Res	Type
1	K5	67	LYS

*Continued on next page...*

*Continued from previous page...*

Mol	Chain	Res	Type
1	K5	94	ARG
4	G2	51	LEU
1	K2	130	ASN
1	K3	154	VAL
3	B3	28	ALA

### 5.3.2 Protein sidechains [i](#)

In the following table, the Percentiles column shows the percent sidechain outliers of the chain as a percentile score with respect to all PDB entries followed by that with respect to all EM entries.

The Analysed column shows the number of residues for which the sidechain conformation was analysed, and the total number of residues.

Mol	Chain	Analysed	Rotameric	Outliers	Percentiles
1	K1	175/199 (88%)	171 (98%)	4 (2%)	50 71
1	K2	175/199 (88%)	171 (98%)	4 (2%)	50 71
1	K3	175/199 (88%)	168 (96%)	7 (4%)	31 59
1	K4	175/199 (88%)	170 (97%)	5 (3%)	42 66
1	K5	175/199 (88%)	169 (97%)	6 (3%)	37 64
2	C1	326/346 (94%)	317 (97%)	9 (3%)	43 67
2	C2	326/346 (94%)	312 (96%)	14 (4%)	29 58
2	C3	326/346 (94%)	317 (97%)	9 (3%)	43 67
2	C4	326/346 (94%)	321 (98%)	5 (2%)	65 80
2	C5	326/346 (94%)	313 (96%)	13 (4%)	31 59
3	B1	282/283 (100%)	278 (99%)	4 (1%)	67 81
3	B2	282/283 (100%)	275 (98%)	7 (2%)	47 70
3	B3	282/283 (100%)	276 (98%)	6 (2%)	53 73
3	B4	282/283 (100%)	278 (99%)	4 (1%)	67 81
3	B5	282/283 (100%)	275 (98%)	7 (2%)	47 70
4	G1	51/58 (88%)	49 (96%)	2 (4%)	32 60
4	G2	51/58 (88%)	48 (94%)	3 (6%)	19 51
4	G3	51/58 (88%)	51 (100%)	0	100 100
4	G4	51/58 (88%)	49 (96%)	2 (4%)	32 60
4	G5	51/58 (88%)	48 (94%)	3 (6%)	19 51

*Continued on next page...*

*Continued from previous page...*

Mol	Chain	Analysed	Rotameric	Outliers	Percentiles
All	All	4170/4430 (94%)	4056 (97%)	114 (3%)	48 68

All (114) residues with a non-rotameric sidechain are listed below:

Mol	Chain	Res	Type
1	K1	71	TYR
1	K1	162	GLN
1	K1	164	GLN
1	K1	171	MET
1	K2	44	LYS
1	K2	77	ASP
1	K2	84	LYS
1	K2	90	TYR
1	K3	71	TYR
1	K3	90	TYR
1	K3	111	LEU
1	K3	151	GLN
1	K3	162	GLN
1	K3	171	MET
1	K3	219	GLU
1	K4	165	GLU
1	K4	167	GLU
1	K4	171	MET
1	K4	191	TYR
1	K4	193	TYR
1	K5	67	LYS
1	K5	93	ASP
1	K5	94	ARG
1	K5	107	ARG
1	K5	130	ASN
1	K5	171	MET
2	C1	59	ARG
2	C1	126	MET
2	C1	140	TYR
2	C1	201	TYR
2	C1	209	PHE
2	C1	219	MET
2	C1	287	MET
2	C1	298	CYS
2	C1	374	PHE
2	C2	25	MET
2	C2	28	LYS

*Continued on next page...*

*Continued from previous page...*

<b>Mol</b>	<b>Chain</b>	<b>Res</b>	<b>Type</b>
2	C2	52	LEU
2	C2	54	PHE
2	C2	109	TRP
2	C2	154	TYR
2	C2	160	HIS
2	C2	191	MET
2	C2	212	MET
2	C2	215	GLU
2	C2	219	MET
2	C2	247	ARG
2	C2	273	MET
2	C2	299	MET
2	C3	28	LYS
2	C3	64	MET
2	C3	66	LEU
2	C3	130	TYR
2	C3	140	TYR
2	C3	159	ASP
2	C3	184	ARG
2	C3	191	MET
2	C3	273	MET
2	C4	62	TYR
2	C4	116	MET
2	C4	118	MET
2	C4	191	MET
2	C4	219	MET
2	C5	25	MET
2	C5	26	ASP
2	C5	118	MET
2	C5	126	MET
2	C5	188	GLN
2	C5	242	ASN
2	C5	287	MET
2	C5	300	TYR
2	C5	317	MET
2	C5	322	ARG
2	C5	360	PHE
2	C5	364	ARG
2	C5	366	PHE
3	B1	45	MET
3	B1	101	MET
3	B1	105	TYR

*Continued on next page...*

*Continued from previous page...*

<b>Mol</b>	<b>Chain</b>	<b>Res</b>	<b>Type</b>
3	B1	214	ARG
3	B2	55	LEU
3	B2	61	MET
3	B2	101	MET
3	B2	105	TYR
3	B2	168	LEU
3	B2	217	MET
3	B2	292	PHE
3	B3	46	ARG
3	B3	101	MET
3	B3	102	THR
3	B3	105	TYR
3	B3	169	TRP
3	B3	312	ASP
3	B4	46	ARG
3	B4	269	ILE
3	B4	270	ILE
3	B4	286	LEU
3	B5	214	ARG
3	B5	217	MET
3	B5	226	GLU
3	B5	262	MET
3	B5	286	LEU
3	B5	293	ASN
3	B5	323	ASP
4	G1	3	SER
4	G1	46	LYS
4	G2	1	MET
4	G2	5	ASN
4	G2	14	LYS
4	G4	1	MET
4	G4	11	GLN
4	G5	5	ASN
4	G5	14	LYS
4	G5	21	MET

Sometimes sidechains can be flipped to improve hydrogen bonding and reduce clashes. All (26) such sidechains are listed below:

<b>Mol</b>	<b>Chain</b>	<b>Res</b>	<b>Type</b>
1	K2	130	ASN
1	K2	162	GLN
1	K2	192	ASN

*Continued on next page...*

*Continued from previous page...*

Mol	Chain	Res	Type
1	K2	198	GLN
1	K3	156	HIS
1	K4	162	GLN
1	K4	192	ASN
1	K4	210	HIS
1	K5	104	ASN
1	K5	162	GLN
2	C1	100	ASN
2	C1	106	ASN
2	C1	188	GLN
2	C3	185	ASN
2	C3	218	GLN
2	C3	222	GLN
2	C4	286	HIS
2	C4	290	ASN
2	C5	113	GLN
2	C5	163	GLN
2	C5	185	ASN
2	C5	368	GLN
3	B3	110	ASN
3	B3	155	ASN
4	G2	11	GLN
4	G4	18	GLN

### 5.3.3 RNA [i](#)

There are no RNA molecules in this entry.

### 5.4 Non-standard residues in protein, DNA, RNA chains [i](#)

There are no non-standard protein/DNA/RNA residues in this entry.

### 5.5 Carbohydrates [i](#)

There are no monosaccharides in this entry.

### 5.6 Ligand geometry [i](#)

There are no ligands in this entry.

## 5.7 Other polymers [i](#)

There are no such residues in this entry.

## 5.8 Polymer linkage issues [i](#)

There are no chain breaks in this entry.



## 6 Map visualisation [i](#)

This section contains visualisations of the EMDB entry EMD-41996. These allow visual inspection of the internal detail of the map and identification of artifacts.

Images derived from a raw map, generated by summing the deposited half-maps, are presented below the corresponding image components of the primary map to allow further visual inspection and comparison with those of the primary map.

### 6.1 Orthogonal projections [i](#)

#### 6.1.1 Primary map

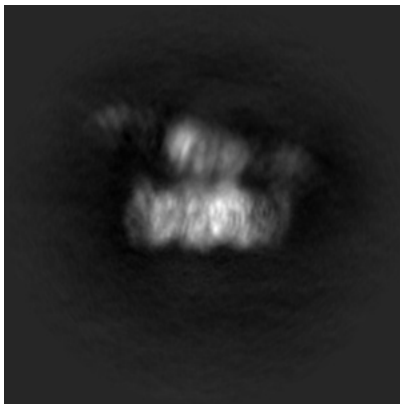

X

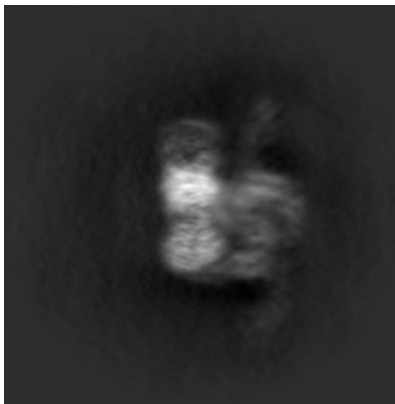

Y

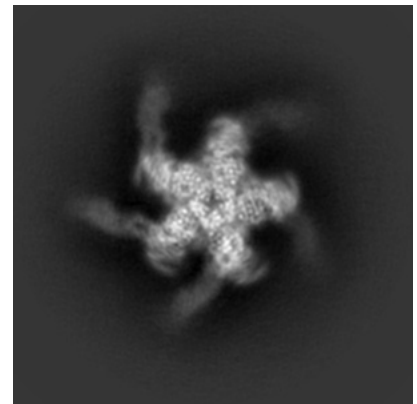

Z

#### 6.1.2 Raw map

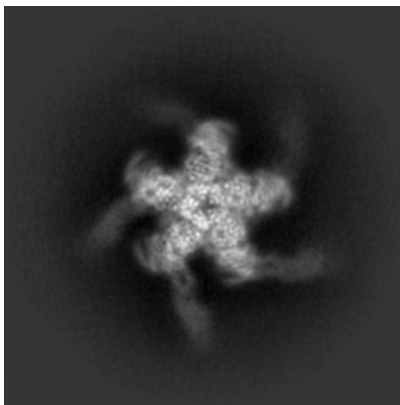

X

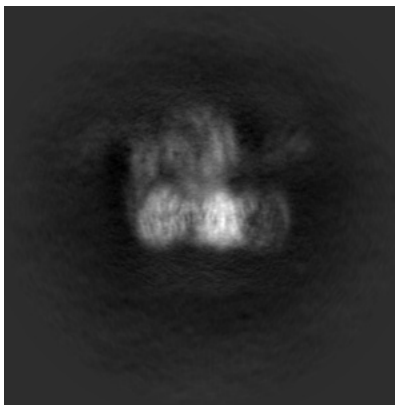

Y

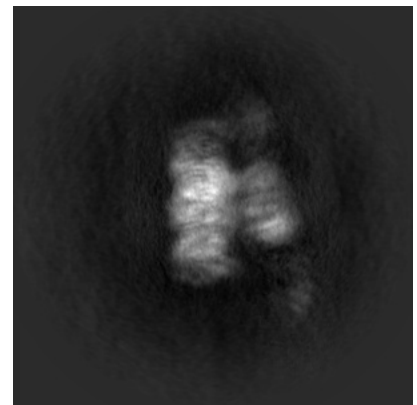

Z

The images above show the map projected in three orthogonal directions.

## 6.2 Central slices [i](#)

### 6.2.1 Primary map

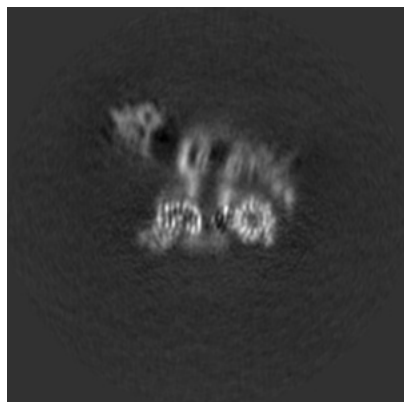

X Index: 162

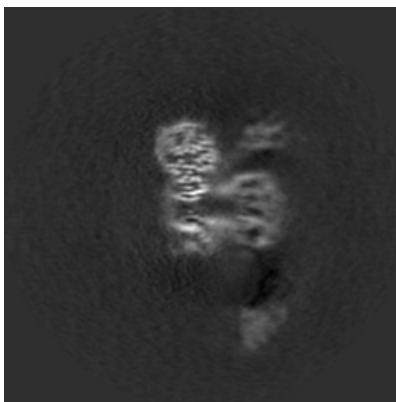

Y Index: 162

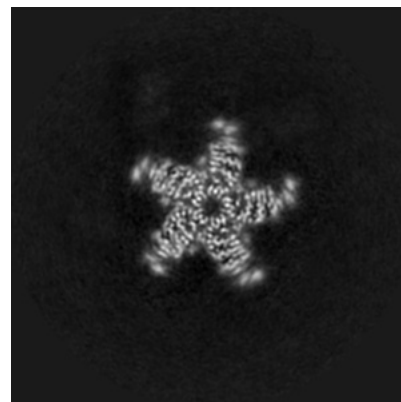

Z Index: 162

### 6.2.2 Raw map

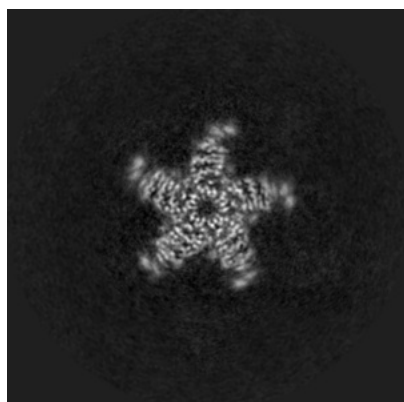

X Index: 162

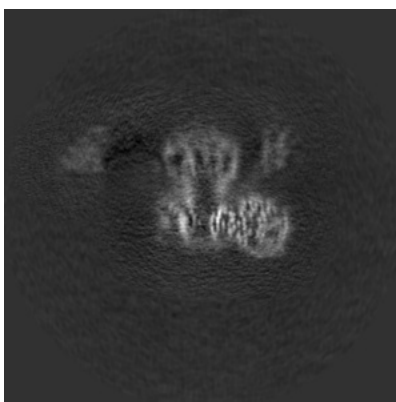

Y Index: 162

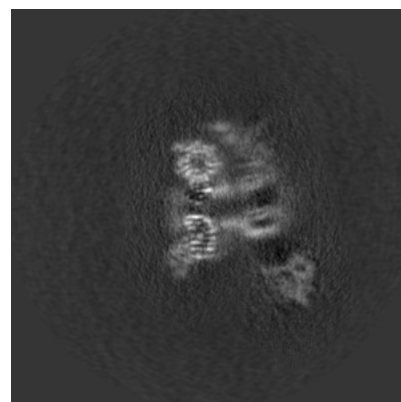

Z Index: 162

The images above show central slices of the map in three orthogonal directions.

## 6.3 Largest variance slices [i](#)

### 6.3.1 Primary map

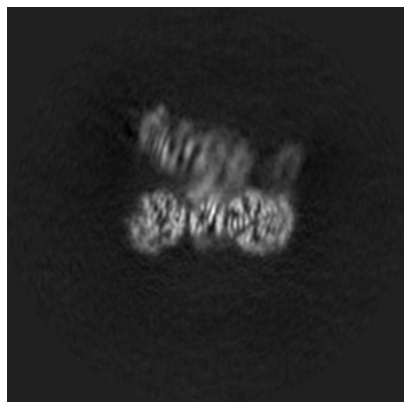

X Index: 176

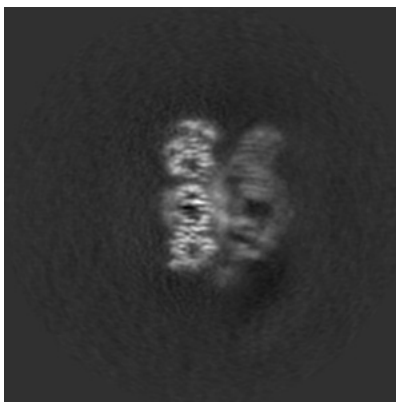

Y Index: 173

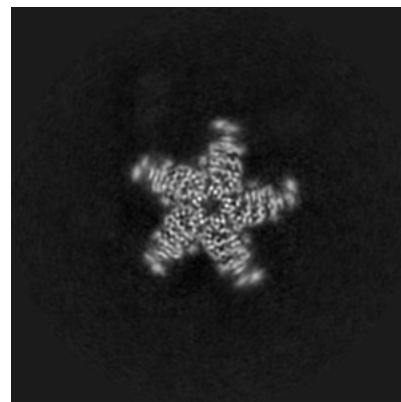

Z Index: 160

### 6.3.2 Raw map

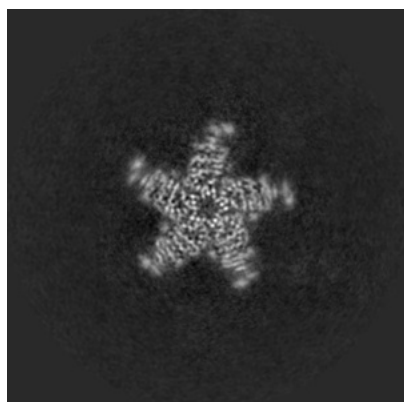

X Index: 160

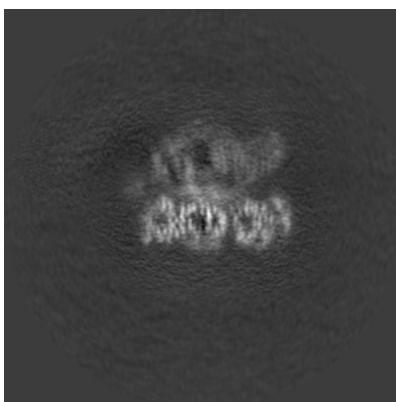

Y Index: 173

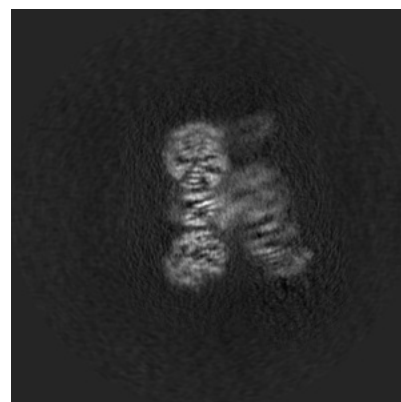

Z Index: 176

The images above show the largest variance slices of the map in three orthogonal directions.

## 6.4 Orthogonal standard-deviation projections (False-color) [i](#)

### 6.4.1 Primary map

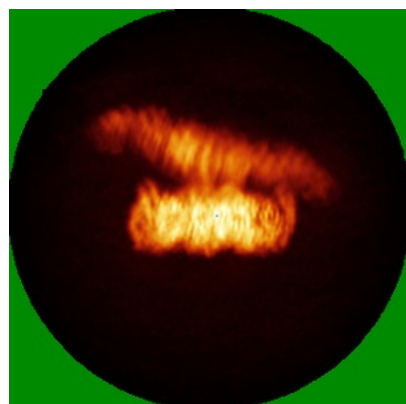

X

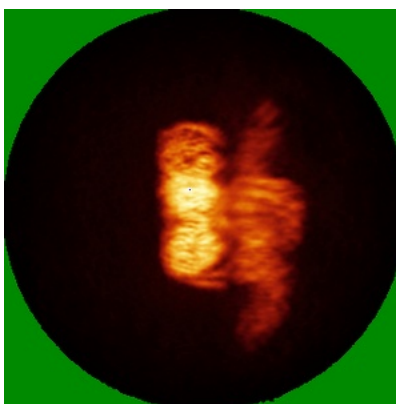

Y

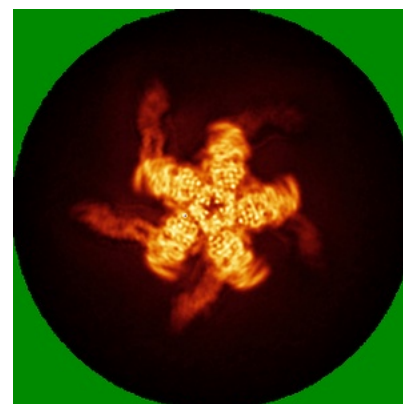

Z

### 6.4.2 Raw map

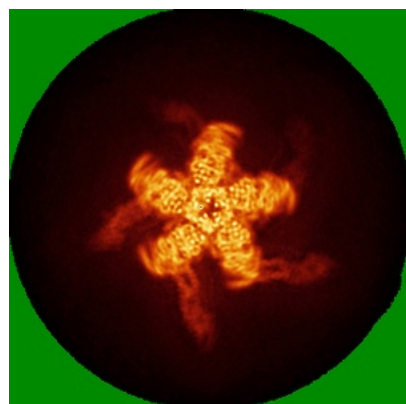

X

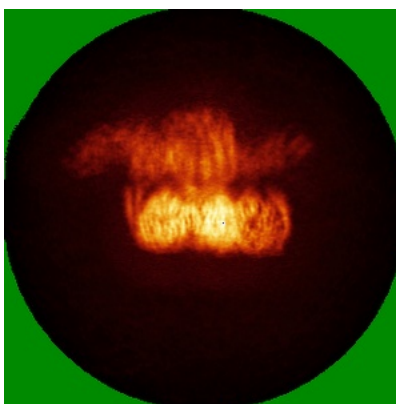

Y

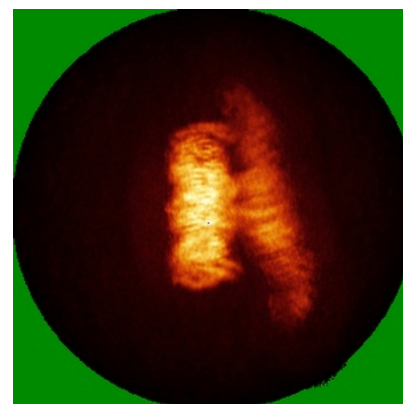

Z

The images above show the map standard deviation projections with false color in three orthogonal directions. Minimum values are shown in green, max in blue, and dark to light orange shades represent small to large values respectively.

## 6.5 Orthogonal surface views [i](#)

### 6.5.1 Primary map



The images above show the 3D surface view of the map at the recommended contour level 1.6. These images, in conjunction with the slice images, may facilitate assessment of whether an appropriate contour level has been provided.

### 6.5.2 Raw map

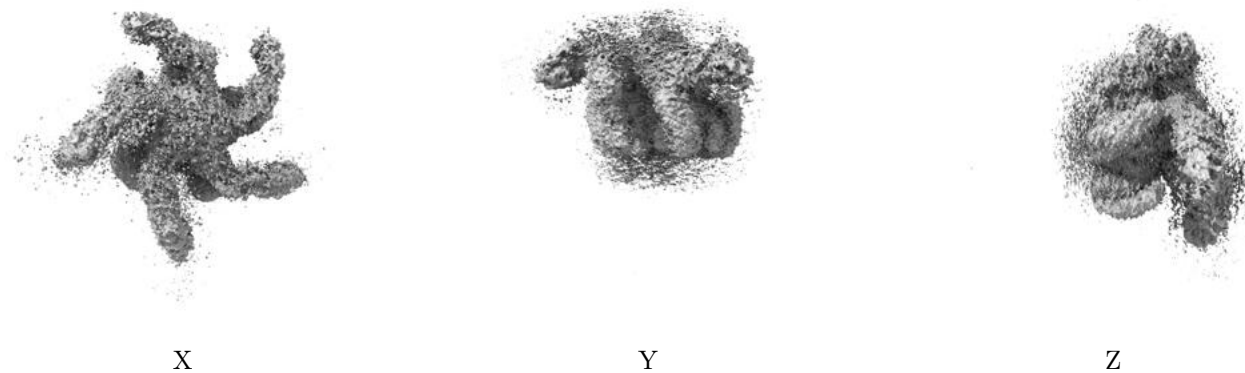

These images show the 3D surface of the raw map. The raw map's contour level was selected so that its surface encloses the same volume as the primary map does at its recommended contour level.

## 6.6 Mask visualisation [i](#)

This section shows the 3D surface view of the primary map at 50% transparency overlaid with the specified mask at 0% transparency

A mask typically either:

- Encompasses the whole structure
- Separates out a domain, a functional unit, a monomer or an area of interest from a larger structure

### 6.6.1 emd\_41996\_msk\_1.map [i](#)

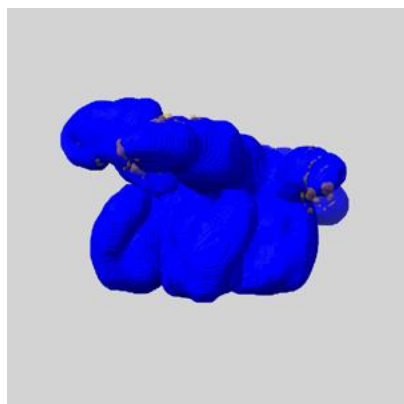

X

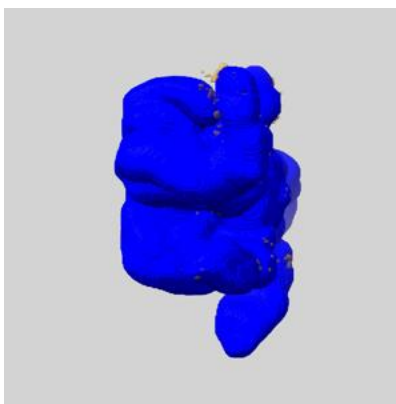

Y

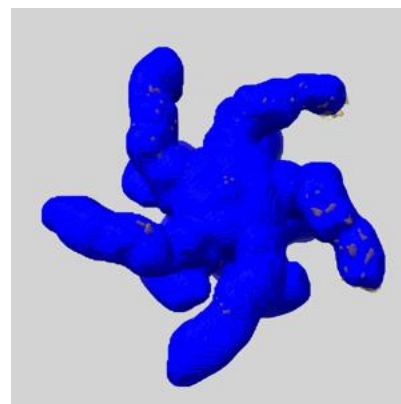

Z

## 7 Map analysis [i](#)

This section contains the results of statistical analysis of the map.

### 7.1 Map-value distribution [i](#)

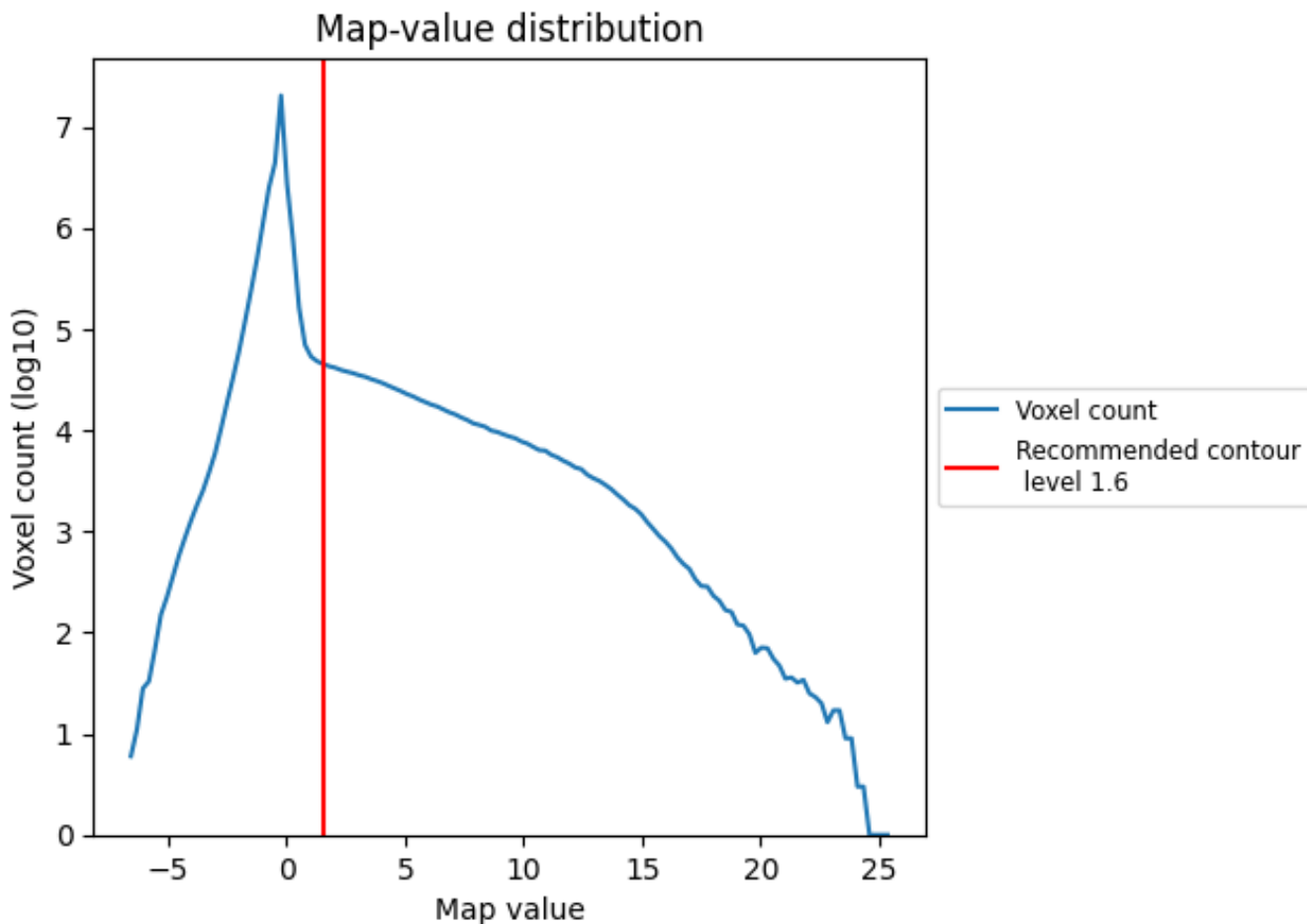

The map-value distribution is plotted in 128 intervals along the x-axis. The y-axis is logarithmic. A spike in this graph at zero usually indicates that the volume has been masked.

## 7.2 Volume estimate [i](#)

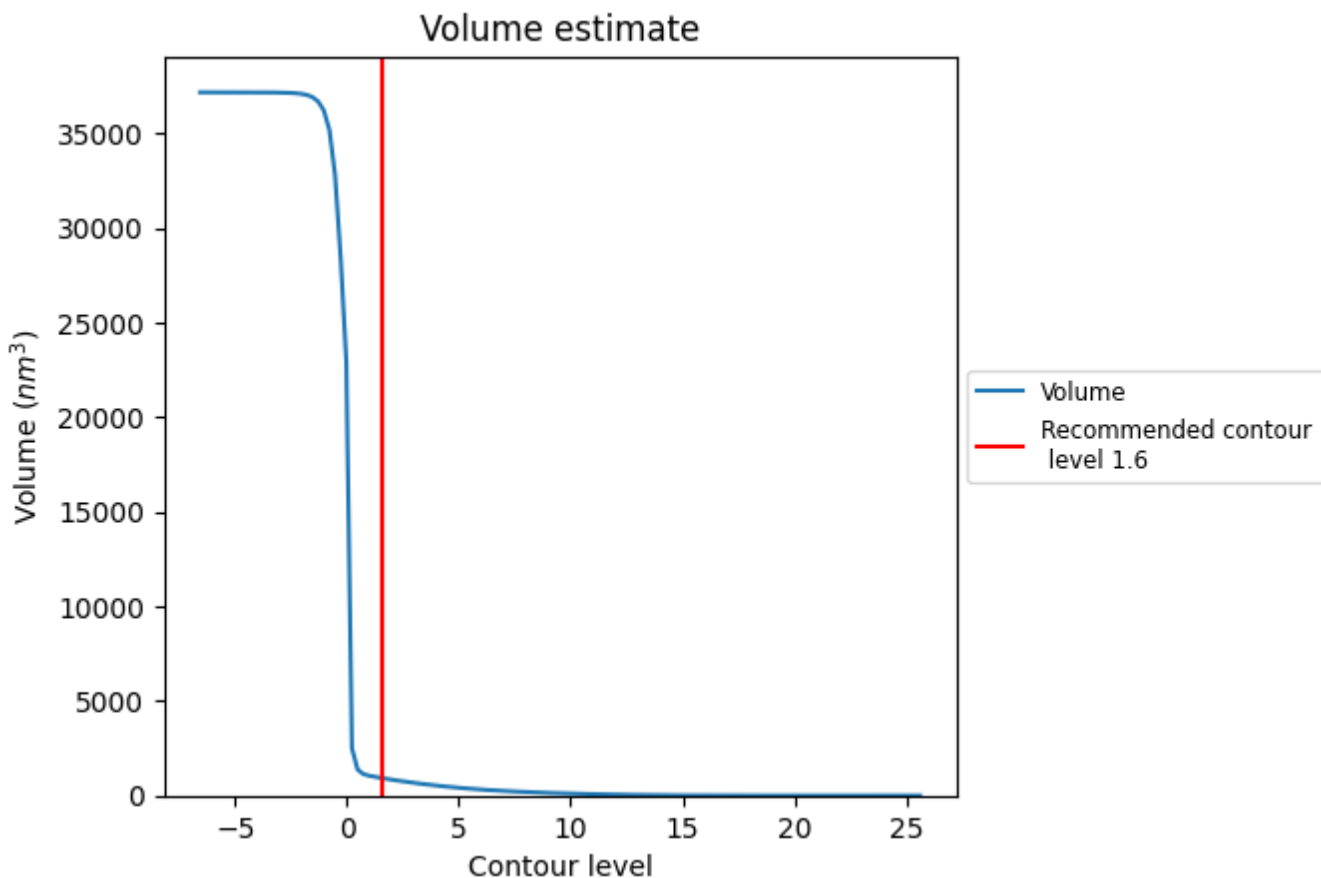

The volume at the recommended contour level is 917 nm<sup>3</sup>; this corresponds to an approximate mass of 828 kDa.

The volume estimate graph shows how the enclosed volume varies with the contour level. The recommended contour level is shown as a vertical line and the intersection between the line and the curve gives the volume of the enclosed surface at the given level.



### 7.3 Rotationally averaged power spectrum i

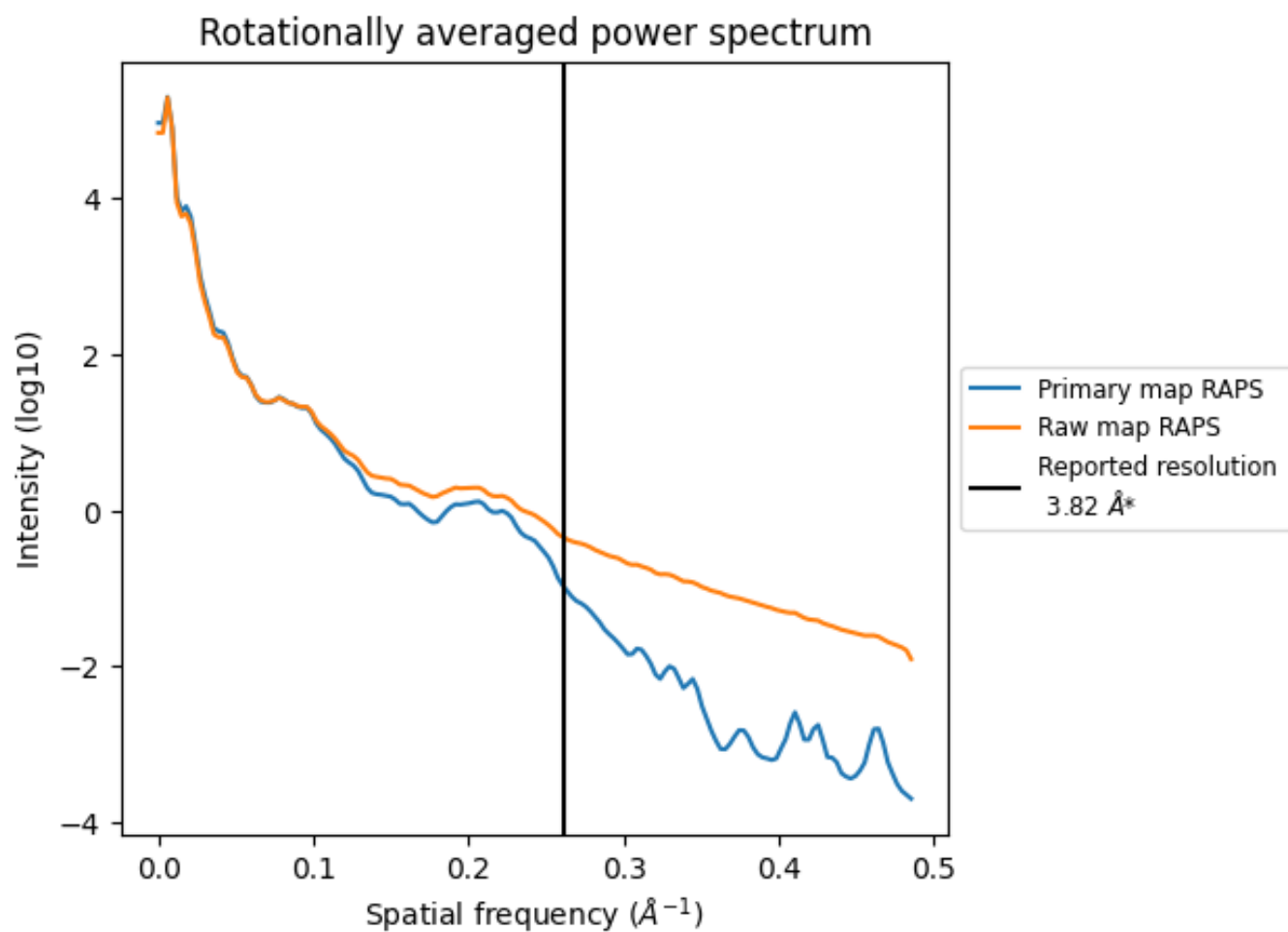

\*Reported resolution corresponds to spatial frequency of 0.262 Å<sup>-1</sup>

## 8 Fourier-Shell correlation [i](#)

Fourier-Shell Correlation (FSC) is the most commonly used method to estimate the resolution of single-particle and subtomogram-averaged maps. The shape of the curve depends on the imposed symmetry, mask and whether or not the two 3D reconstructions used were processed from a common reference. The reported resolution is shown as a black line. A curve is displayed for the half-bit criterion in addition to lines showing the 0.143 gold standard cut-off and 0.5 cut-off.

### 8.1 FSC [i](#)

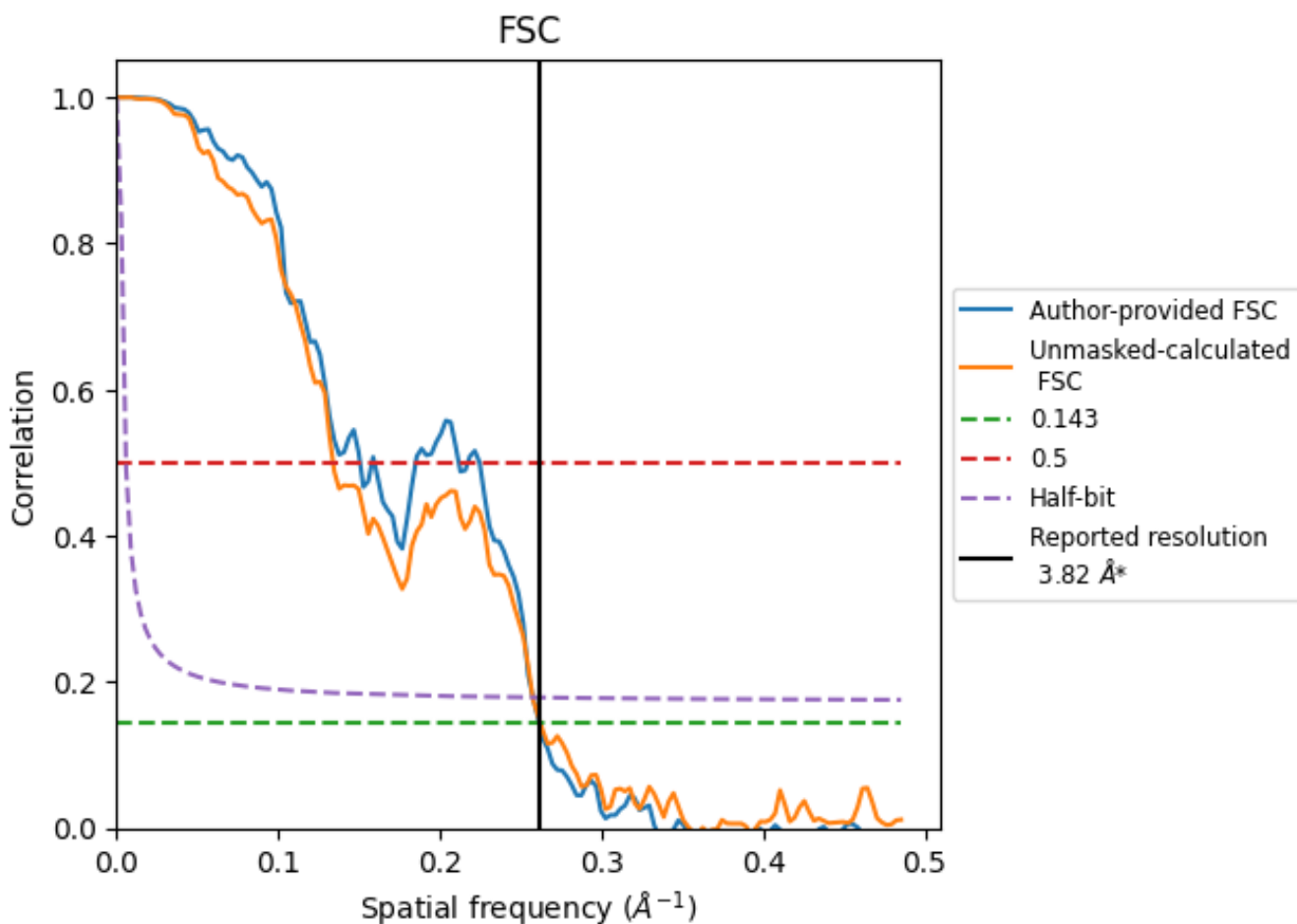

\*Reported resolution corresponds to spatial frequency of  $0.262 \text{\AA}^{-1}$

## 8.2 Resolution estimates [i](#)

Resolution estimate (Å)	Estimation criterion (FSC cut-off)		
	0.143	0.5	Half-bit
Reported by author	3.82	-	-
Author-provided FSC curve	3.82	6.64	3.88
Unmasked-calculated*	3.81	7.46	3.88

\*Resolution estimate based on FSC curve calculated by comparison of deposited half-maps.

## 9 Map-model fit [i](#)

This section contains information regarding the fit between EMDB map EMD-41996 and PDB model 8U81. Per-residue inclusion information can be found in section 3 on page 6.

### 9.1 Map-model overlay [i](#)

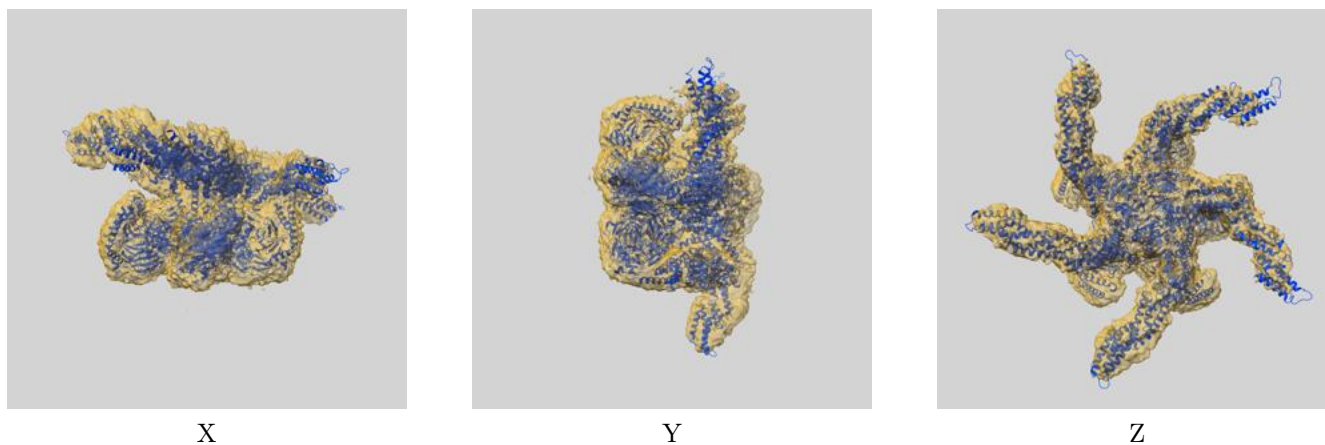

The images above show the 3D surface view of the map at the recommended contour level 1.6 at 50% transparency in yellow overlaid with a ribbon representation of the model coloured in blue. These images allow for the visual assessment of the quality of fit between the atomic model and the map.

## 9.2 Q-score mapped to coordinate model [i](#)

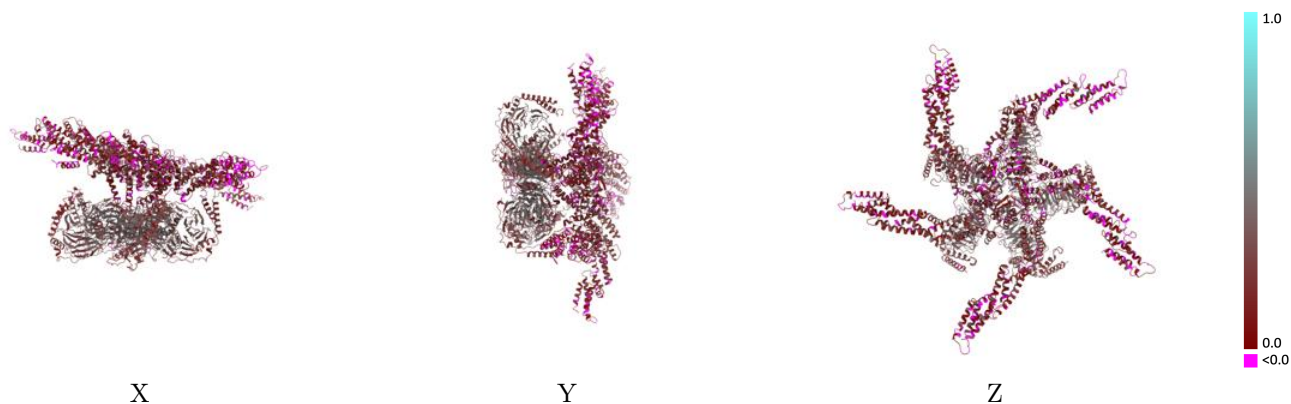

The images above show the model with each residue coloured according to its Q-score. This shows their resolvability in the map with higher Q-score values reflecting better resolvability. Please note: Q-score is calculating the resolvability of atoms, and thus high values are only expected at resolutions at which atoms can be resolved. Low Q-score values may therefore be expected for many entries.

## 9.3 Atom inclusion mapped to coordinate model [i](#)

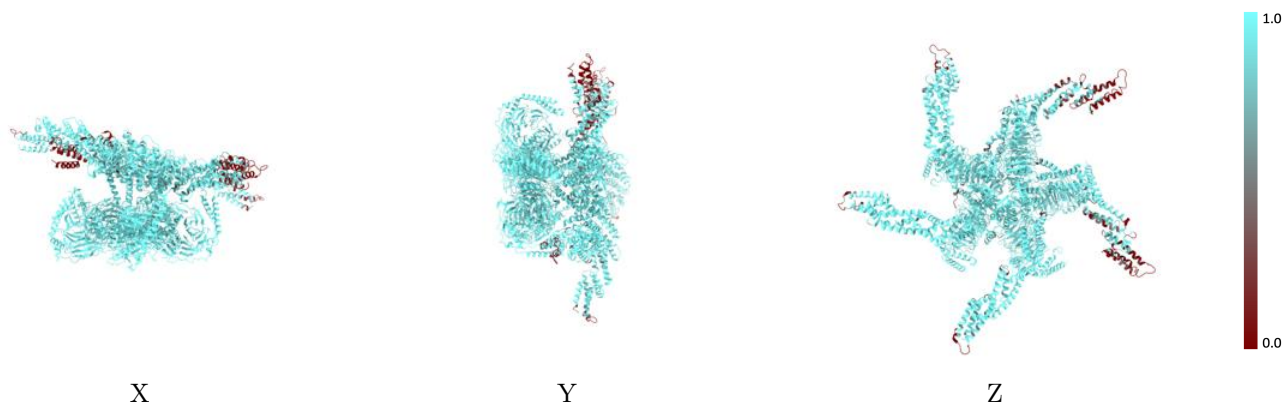

The images above show the model with each residue coloured according to its atom inclusion. This shows to what extent they are inside the map at the recommended contour level (1.6).



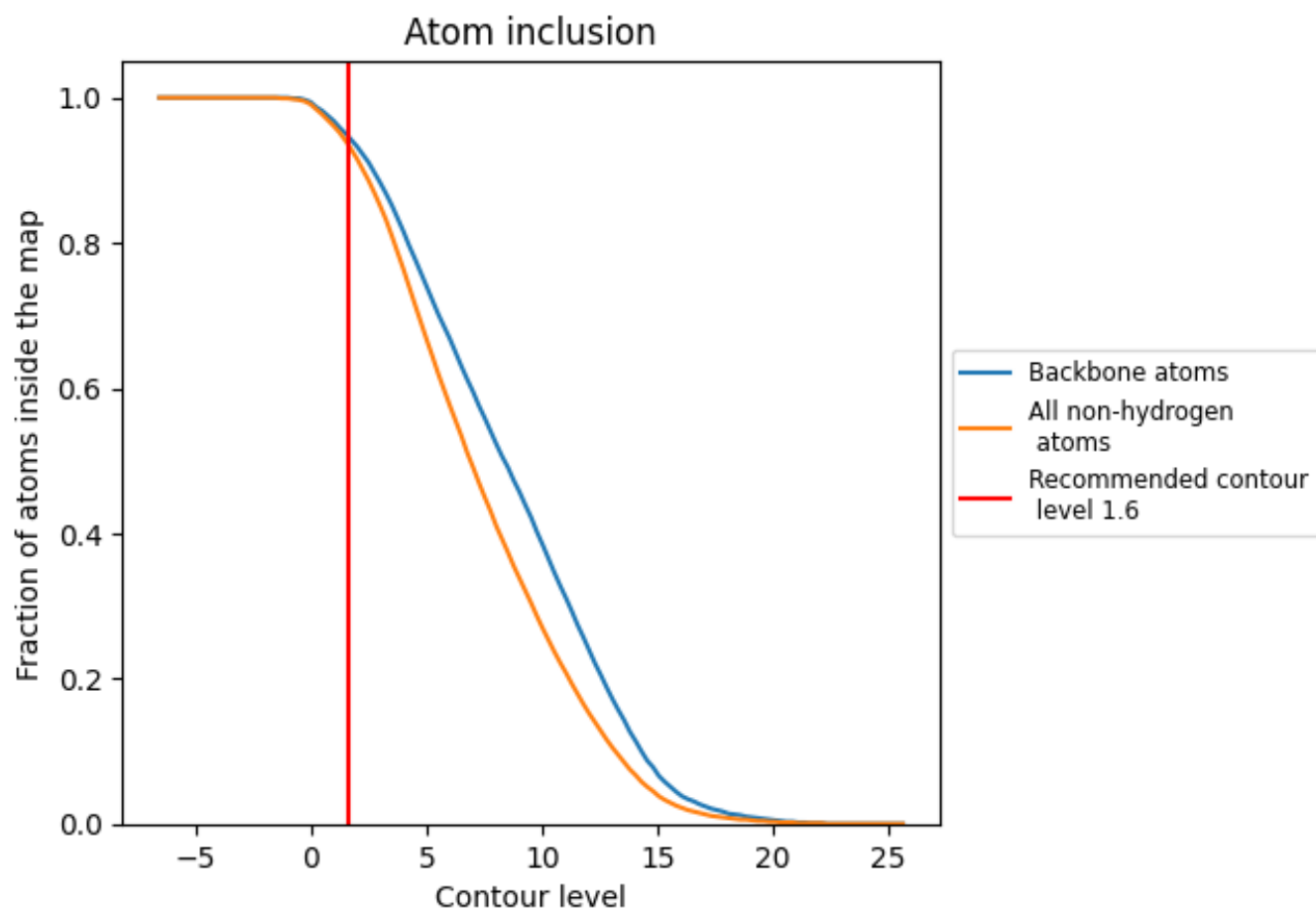







































## 9.4 Atom inclusion [i](#)



At the recommended contour level, 95% of all backbone atoms, 94% of all non-hydrogen atoms, are inside the map.

## 9.5 Map-model fit summary

The table lists the average atom inclusion at the recommended contour level (1.6) and Q-score for the entire model and for each chain.

Chain	Atom inclusion	Q-score
All	 0.9360	 0.2280
B1	 0.9990	 0.3420
B2	 1.0000	 0.3330
B3	 0.9990	 0.3340
B4	 0.9990	 0.3290
B5	 1.0000	 0.3380
C1	 0.9280	 0.1550
C2	 0.7360	 0.1030
C3	 0.6910	 0.1120
C4	 0.8970	 0.1550
C5	 0.9350	 0.1710
G1	 1.0000	 0.2650
G2	 0.9920	 0.2270
G3	 1.0000	 0.2500
G4	 1.0000	 0.2230
G5	 0.9960	 0.2370
K1	 0.9940	 0.2360
K2	 0.9980	 0.2040
K3	 0.9980	 0.1980
K4	 0.9940	 0.2050
K5	 0.9900	 0.2190

