



Full wwPDB EM Validation Report ⓘ

Jul 10, 2024 – 02:04 am BST

PDB ID : 7QJ2
EMDB ID : EMD-14007
Title : Structure of recombinant human gamma-Tubulin Ring Complex 8-spoked assembly intermediate (spokes 5-12)
Authors : Zupa, E.; Pfeffer, S.
Deposited on : 2021-12-16
Resolution : 8.60 Å (reported)
Based on initial models : 6V6S, 7AS4, 6L81, 6X0U

This is a Full wwPDB EM Validation Report for a publicly released PDB entry.

We welcome your comments at validation@mail.wwpdb.org

A user guide is available at

<https://www.wwpdb.org/validation/2017/EMValidationReportHelp>

with specific help available everywhere you see the ⓘ symbol.

The types of validation reports are described at

<http://www.wwpdb.org/validation/2017/FAQs#types>.

The following versions of software and data (see [references ⓘ](#)) were used in the production of this report:

EMDB validation analysis : 0.0.1.dev92
MolProbity : 4.02b-467
Percentile statistics : 20191225.v01 (using entries in the PDB archive December 25th 2019)
MapQ : 1.9.13
Ideal geometry (proteins) : Engh & Huber (2001)
Ideal geometry (DNA, RNA) : Parkinson et al. (1996)
Validation Pipeline (wwPDB-VP) : 2.37.1

1 Overall quality at a glance i

The following experimental techniques were used to determine the structure:

ELECTRON MICROSCOPY

The reported resolution of this entry is 8.60 Å.

Percentile scores (ranging between 0-100) for global validation metrics of the entry are shown in the following graphic. The table shows the number of entries on which the scores are based.

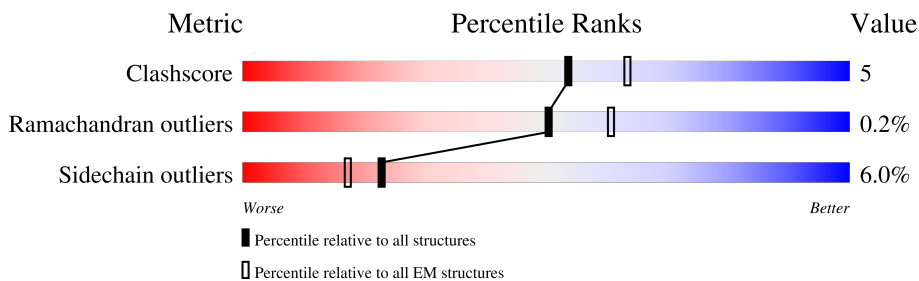

Metric	Whole archive (#Entries)	EM structures (#Entries)
Clashscore	158937	4297
Ramachandran outliers	154571	4023
Sidechain outliers	154315	3826

The table below summarises the geometric issues observed across the polymeric chains and their fit to the map. The red, orange, yellow and green segments of the bar indicate the fraction of residues that contain outliers for ≥ 3 , 2, 1 and 0 types of geometric quality criteria respectively. A grey segment represents the fraction of residues that are not modelled. The numeric value for each fraction is indicated below the corresponding segment, with a dot representing fractions $\leq 5\%$. The upper red bar (where present) indicates the fraction of residues that have poor fit to the EM map (all-atom inclusion $< 40\%$). The numeric value is given above the bar.

Mol	Chain	Length	Quality of chain
1	J	1024	
1	l	1024	
2	F	907	
2	H	907	
2	a	907	
2	j	907	
3	b	82	
3	k	82	

Continued on next page...

Continued from previous page...

Mol	Chain	Length	Quality of chain
3	m	82	 67% 11% 21%
4	E	902	 23% 59% 11% 29%
4	G	902	 61% 9% 29%
5	I	667	 68% 10% 22%
5	K	667	 72% 11% 16%
6	L	1819	 27% 69%
7	S	451	 57% 69% 20% 7%
7	T	451	 8% 69% 20% 7%
7	U	451	 70% 20% 7%
7	V	451	 69% 20% 7%
7	W	451	 70% 19% 7%
7	X	451	 70% 19% 7%
7	Y	451	 69% 20% 7%
7	Z	451	 69% 20% 7%

2 Entry composition [i](#)

There are 7 unique types of molecules in this entry. The entry contains 69095 atoms, of which 0 are hydrogens and 0 are deuteriums.

In the tables below, the AltConf column contains the number of residues with at least one atom in alternate conformation and the Trace column contains the number of residues modelled with at most 2 atoms.

- Molecule 1 is a protein called Gamma-tubulin complex component 5.

Mol	Chain	Residues	Atoms					AltConf	Trace
			Total	C	N	O	S		
1	l	108	Total 847	C 539	N 150	O 157	S 1	0	0
1	J	534	Total 4429	C 2893	N 737	O 776	S 23	0	0

- Molecule 2 is a protein called Gamma-tubulin complex component 3.

Mol	Chain	Residues	Atoms					AltConf	Trace
			Total	C	N	O	S		
2	j	99	Total 803	C 509	N 148	O 144	S 2	0	0
2	F	599	Total 4941	C 3151	N 871	O 894	S 25	0	0
2	H	594	Total 4907	C 3130	N 864	O 888	S 25	0	0
2	a	116	Total 933	C 591	N 171	O 169	S 2	0	0

- Molecule 3 is a protein called Mitotic-spindle organizing protein 1.

Mol	Chain	Residues	Atoms					AltConf	Trace
			Total	C	N	O	S		
3	m	65	Total 484	C 299	N 85	O 96	S 4	0	0
3	k	65	Total 484	C 299	N 85	O 96	S 4	0	0
3	b	65	Total 484	C 299	N 85	O 96	S 4	0	0

- Molecule 4 is a protein called Gamma-tubulin complex component 2.

Mol	Chain	Residues	Atoms					AltConf	Trace
			Total	C	N	O	S		
4	E	638	Total 5202	C 3354	N 873	O 942	S 33	0	0

Continued on next page...

Continued from previous page...

Mol	Chain	Residues	Atoms					AltConf	Trace
			Total	C	N	O	S		
4	G	640	5206	3354	875	944	33	0	0

- Molecule 5 is a protein called Gamma-tubulin complex component 4.

Mol	Chain	Residues	Atoms					AltConf	Trace
			Total	C	N	O	S		
5	I	521	4225	2737	720	750	18	0	0
5	K	562	4579	2964	781	816	18	0	0

- Molecule 6 is a protein called Gamma-tubulin complex component 6.

Mol	Chain	Residues	Atoms					AltConf	Trace
			Total	C	N	O	S		
6	L	566	4587	3000	773	789	25	0	0

- Molecule 7 is a protein called Tubulin gamma-1 chain.

Mol	Chain	Residues	Atoms					AltConf	Trace
			Total	C	N	O	S		
7	S	420	3373	2134	586	638	15	0	0
7	T	420	3373	2134	586	638	15	0	0
7	U	420	3373	2134	586	638	15	0	0
7	V	420	3373	2134	586	638	15	0	0
7	W	420	3373	2134	586	638	15	0	0
7	X	420	3373	2134	586	638	15	0	0
7	Y	420	3373	2134	586	638	15	0	0
7	Z	420	3373	2134	586	638	15	0	0

3 Residue-property plots

These plots are drawn for all protein, RNA, DNA and oligosaccharide chains in the entry. The first graphic for a chain summarises the proportions of the various outlier classes displayed in the second graphic. The second graphic shows the sequence view annotated by issues in geometry and atom inclusion in map density. Residues are color-coded according to the number of geometric quality criteria for which they contain at least one outlier: green = 0, yellow = 1, orange = 2 and red = 3 or more. A red diamond above a residue indicates a poor fit to the EM map for this residue (all-atom inclusion < 40%). Stretches of 2 or more consecutive residues without any outlier are shown as a green connector. Residues present in the sample, but not in the model, are shown in grey.

- Molecule 1: Gamma-tubulin complex component 5

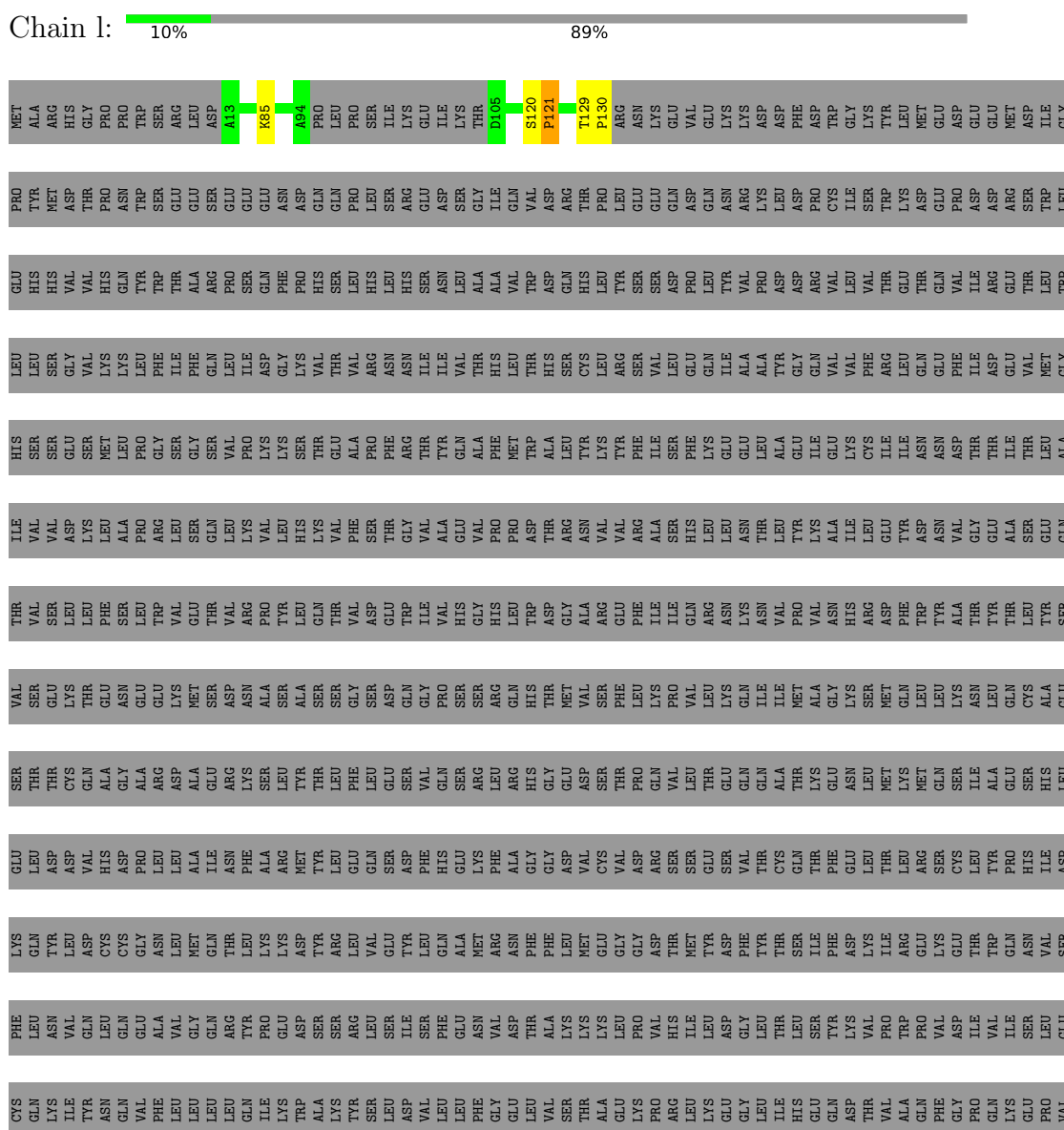

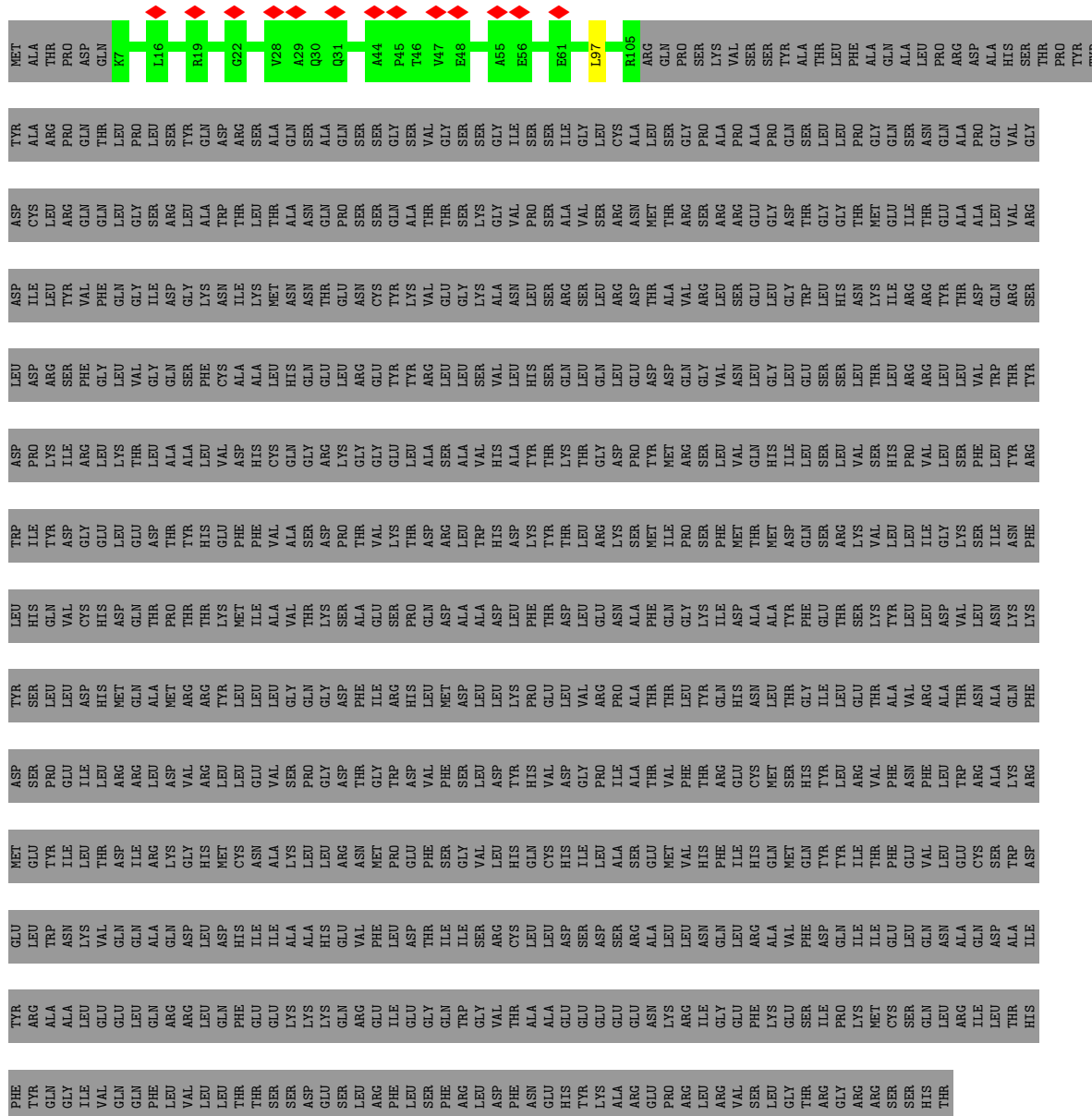

● Molecule 2: Gamma-tubulin complex component 3

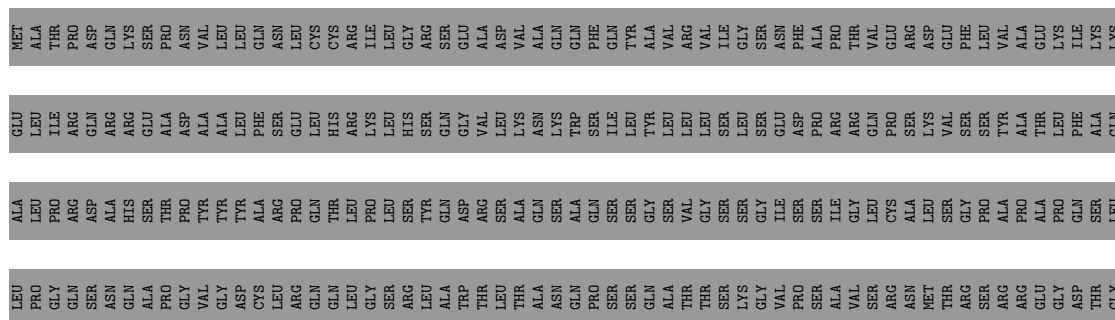

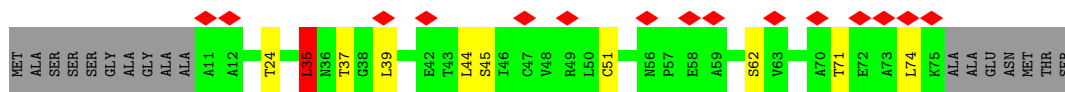

• Molecule 3: Mitotic-spindle organizing protein 1

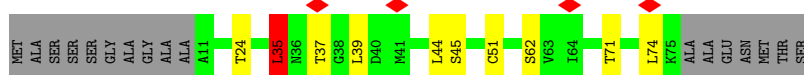

• Molecule 4: Gamma-tubulin complex component 2

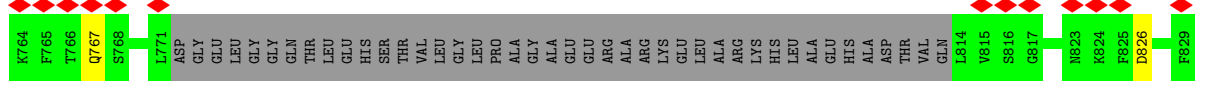
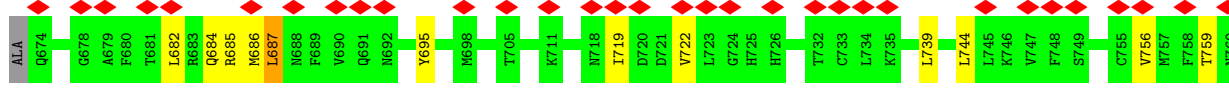
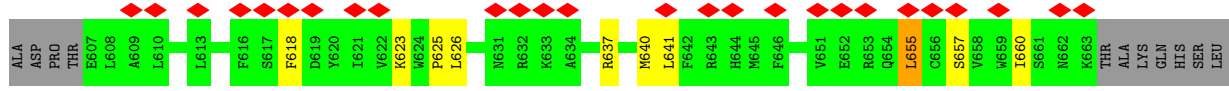
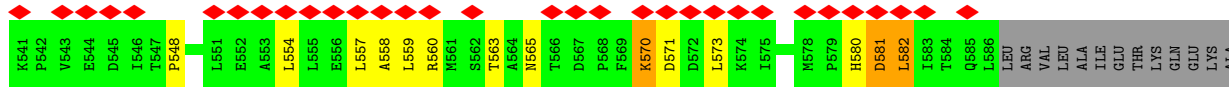
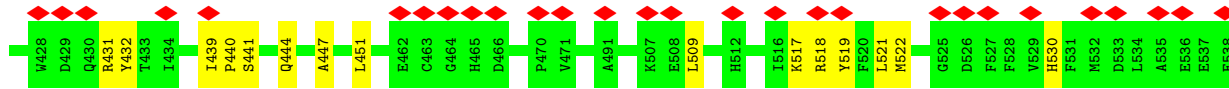
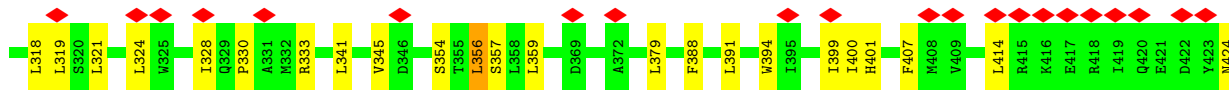
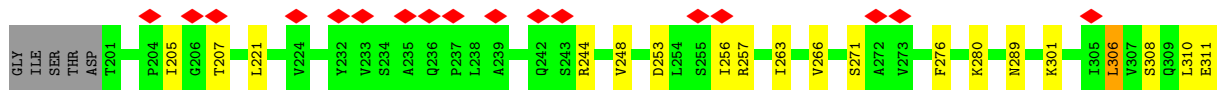
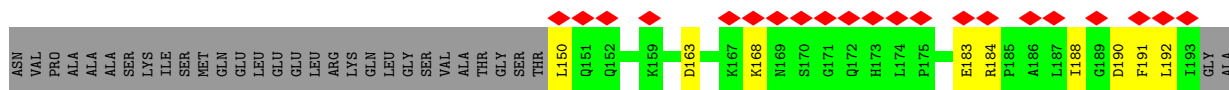
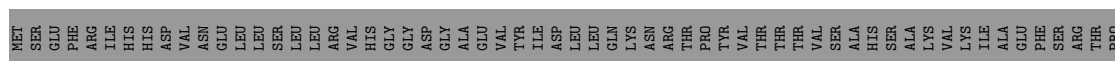

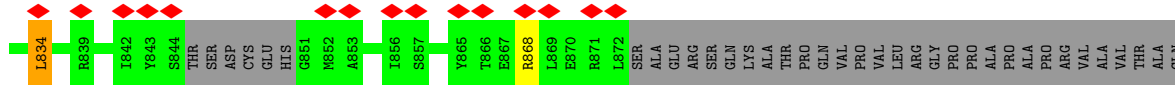

- Molecule 4: Gamma-tubulin complex component 2

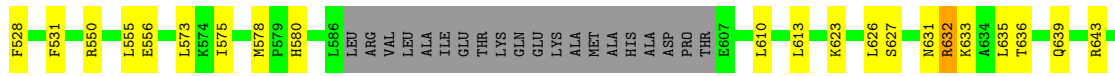
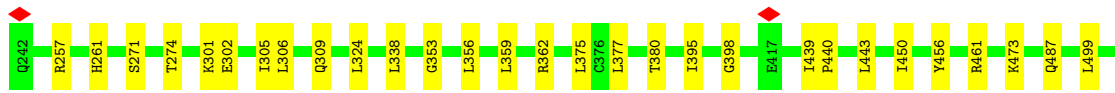
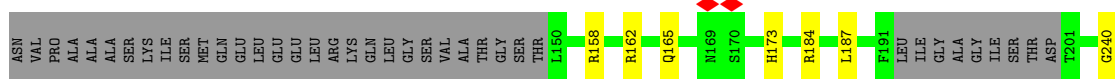

- Molecule 5: Gamma-tubulin complex component 4

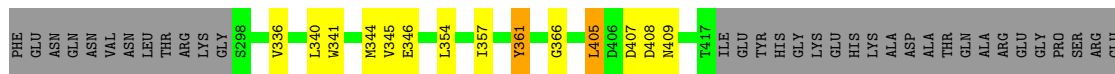
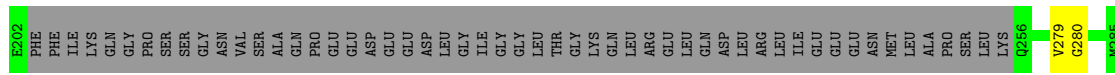
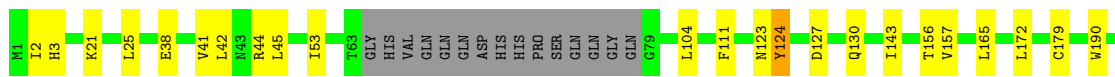

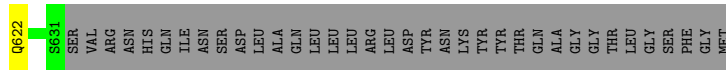

● Molecule 5: Gamma-tubulin complex component 4

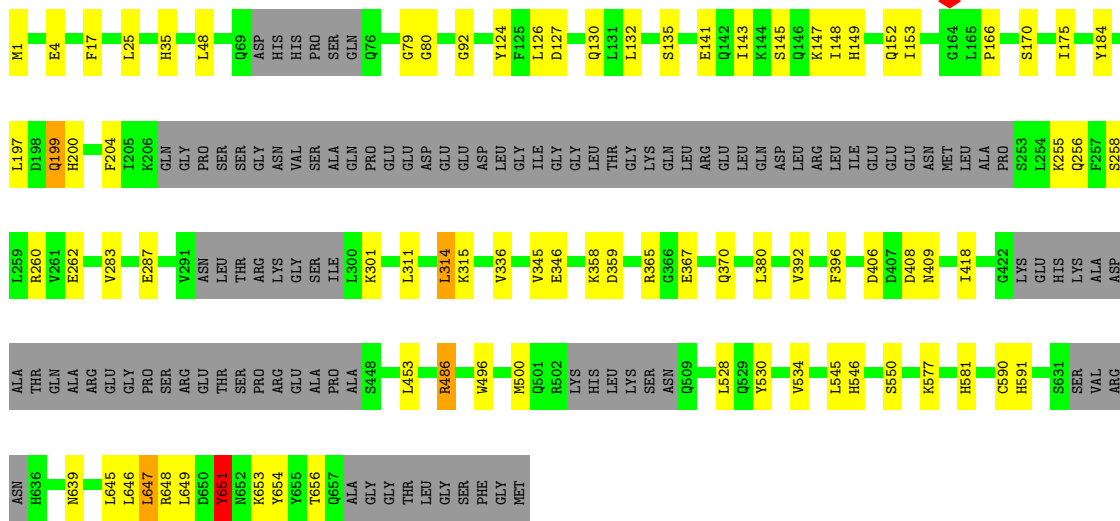

● Molecule 6: Gamma-tubulin complex component 6

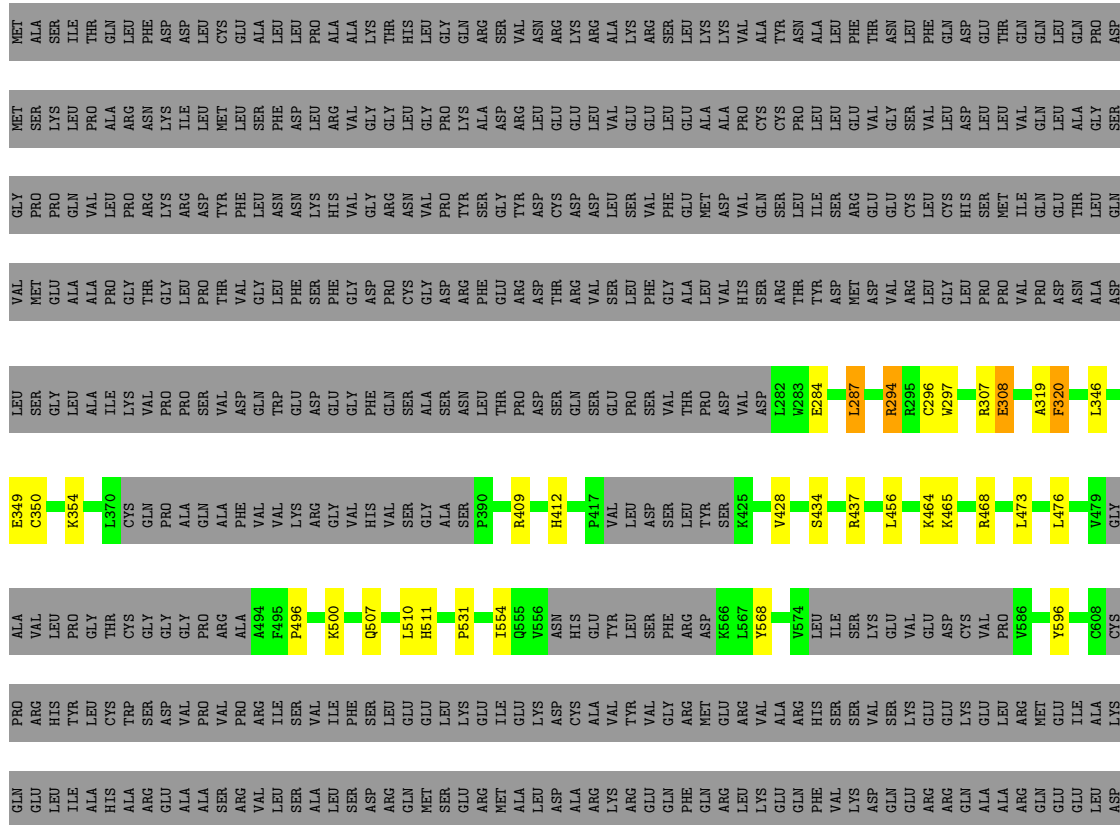

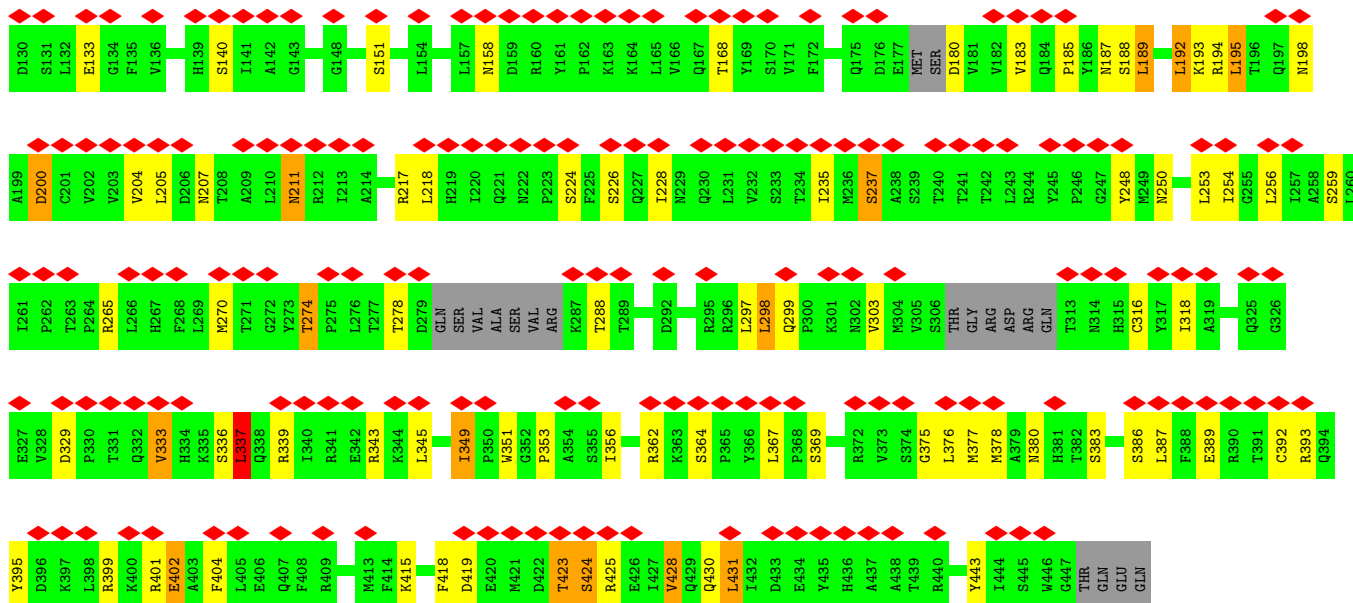

• Molecule 7: Tubulin gamma-1 chain

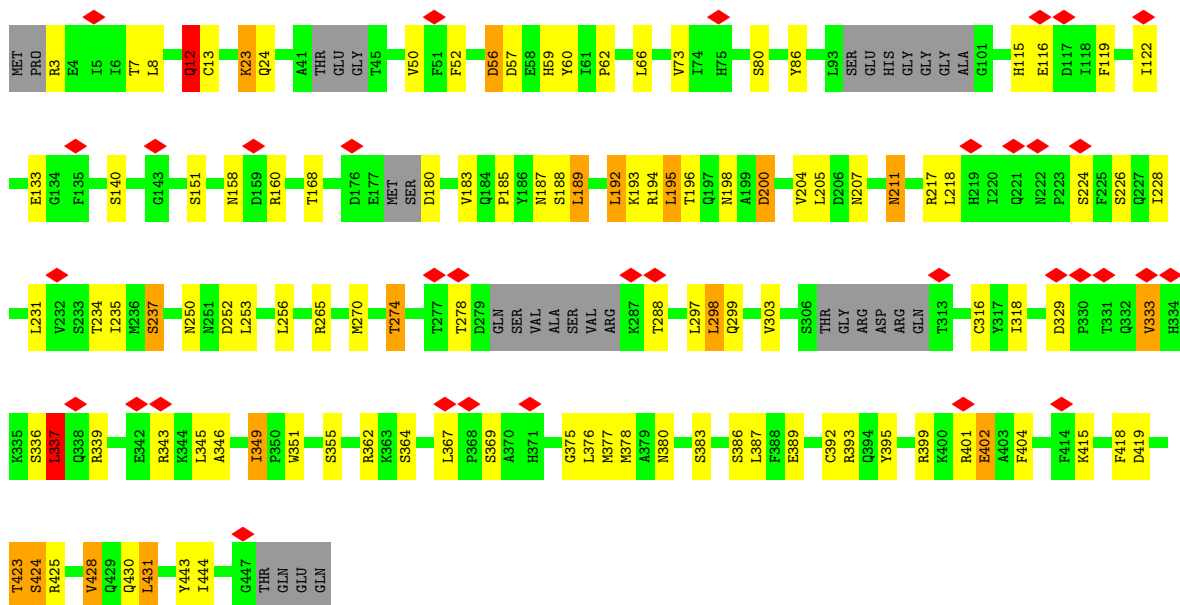

• Molecule 7: Tubulin gamma-1 chain



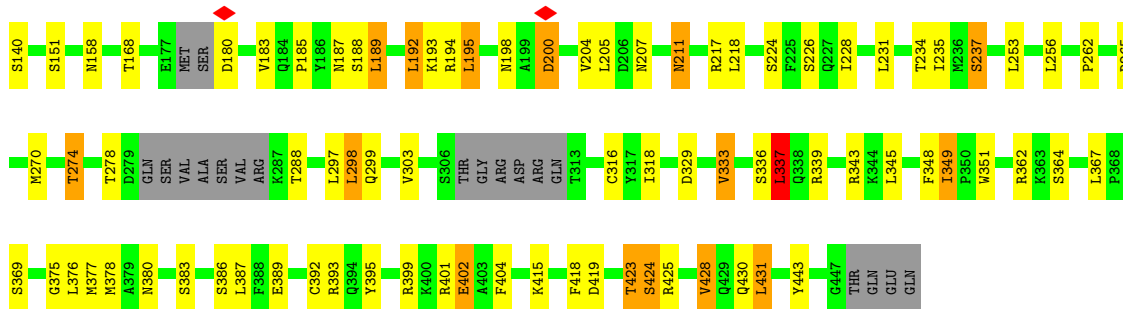

• Molecule 7: Tubulin gamma-1 chain

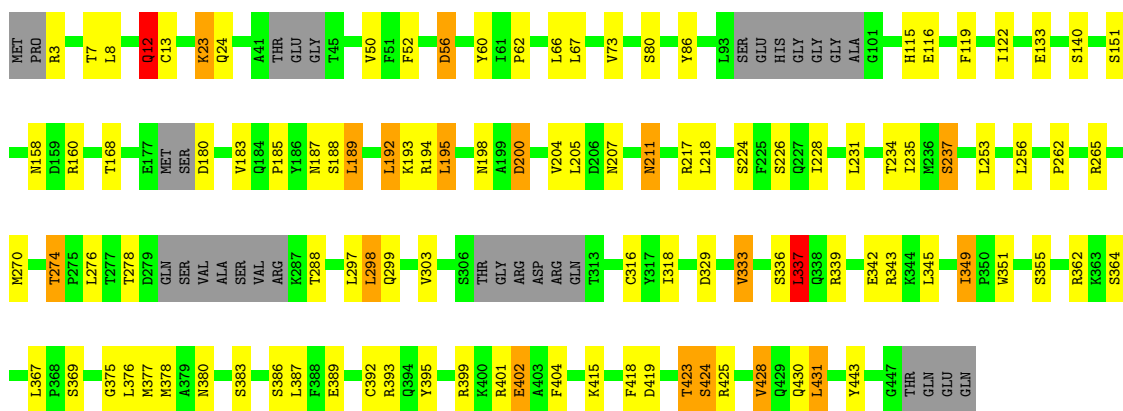

• Molecule 7: Tubulin gamma-1 chain

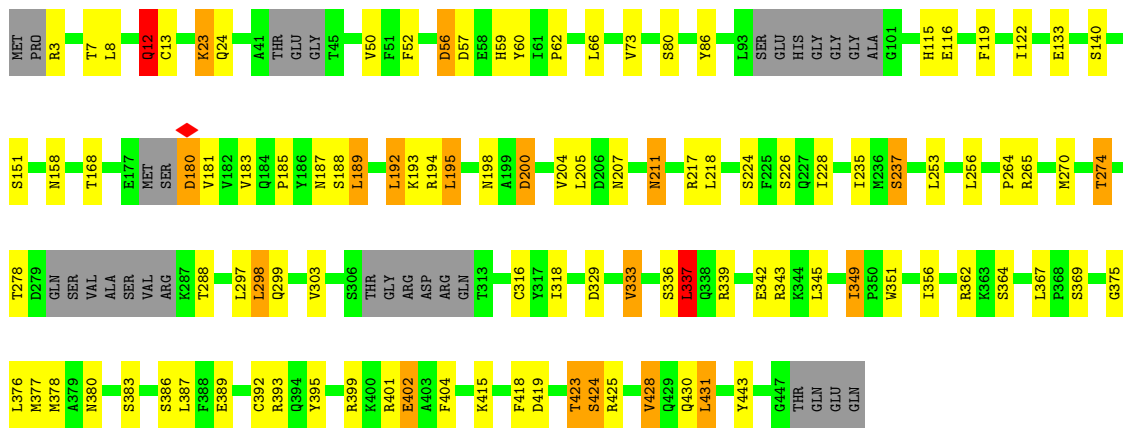

• Molecule 7: Tubulin gamma-1 chain



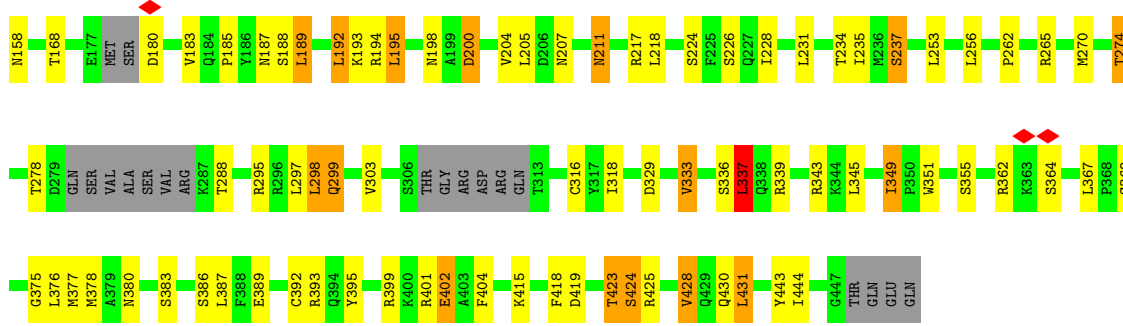

• Molecule 7: Tubulin gamma-1 chain

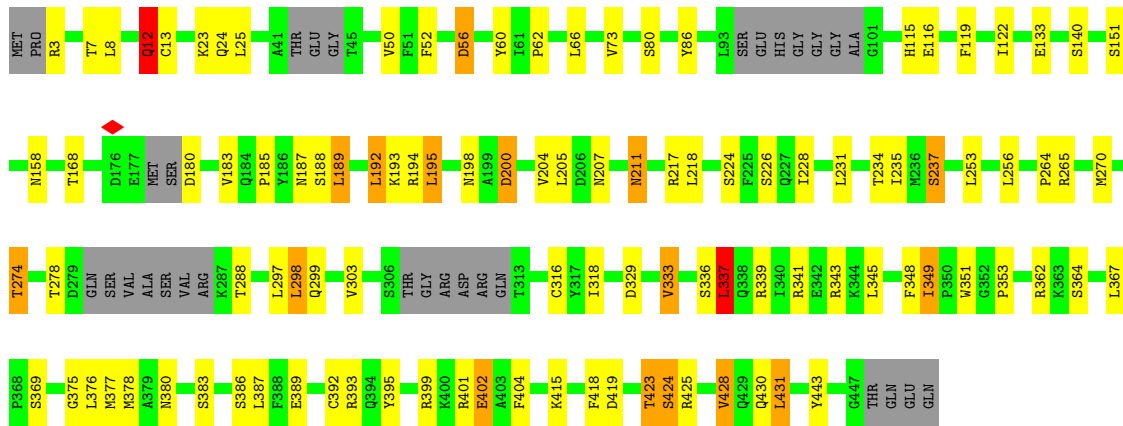

• Molecule 7: Tubulin gamma-1 chain

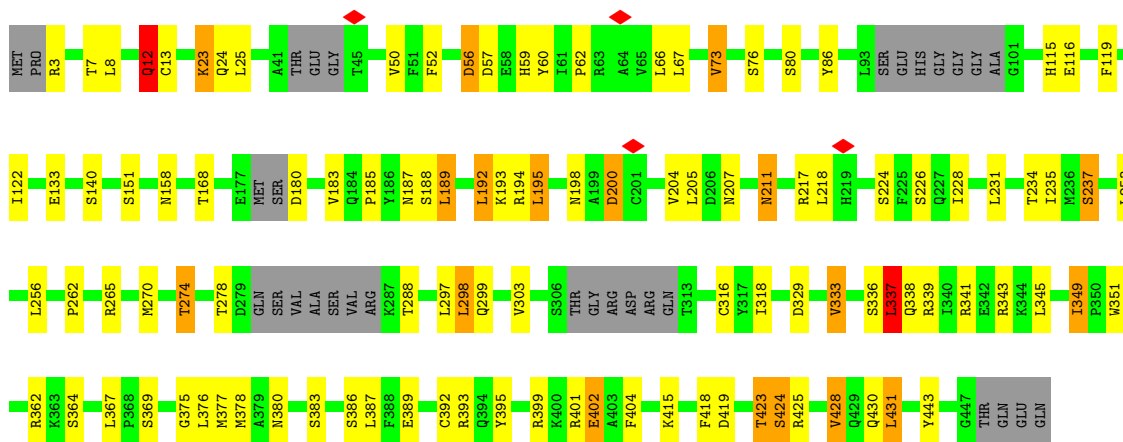

4 Experimental information

Property	Value	Source
EM reconstruction method	SINGLE PARTICLE	Depositor
Imposed symmetry	POINT, Not provided	
Number of particles used	10965	Depositor
Resolution determination method	FSC 0.143 CUT-OFF	Depositor
CTF correction method	PHASE FLIPPING AND AMPLITUDE CORRECTION	Depositor
Microscope	FEI TITAN KRIOS	Depositor
Voltage (kV)	300	Depositor
Electron dose ($e^-/\text{\AA}^2$)	35	Depositor
Minimum defocus (nm)	2000	Depositor
Maximum defocus (nm)	2500	Depositor
Magnification	Not provided	
Image detector	GATAN K3 (6k x 4k)	Depositor
Maximum map value	0.239	Depositor
Minimum map value	-0.083	Depositor
Average map value	0.001	Depositor
Map value standard deviation	0.007	Depositor
Recommended contour level	0.0287	Depositor
Map size (Å)	532.0, 532.0, 532.0	wwPDB
Map dimensions	200, 200, 200	wwPDB
Map angles (°)	90.0, 90.0, 90.0	wwPDB
Pixel spacing (Å)	2.66, 2.66, 2.66	Depositor

5 Model quality i

5.1 Standard geometry i

The Z score for a bond length (or angle) is the number of standard deviations the observed value is removed from the expected value. A bond length (or angle) with $|Z| > 5$ is considered an outlier worth inspection. RMSZ is the root-mean-square of all Z scores of the bond lengths (or angles).

Mol	Chain	Bond lengths		Bond angles	
		RMSZ	# Z >5	RMSZ	# Z >5
1	J	0.47	3/4525 (0.1%)	0.68	3/6119 (0.0%)
1	l	0.35	0/863	0.64	2/1166 (0.2%)
2	F	0.37	0/5044	0.66	4/6809 (0.1%)
2	H	0.40	0/5009	0.64	5/6761 (0.1%)
2	a	0.35	0/948	0.60	0/1277
2	j	0.38	0/815	0.63	1/1096 (0.1%)
3	b	0.35	0/484	0.79	1/653 (0.2%)
3	k	0.36	0/484	0.79	1/653 (0.2%)
3	m	0.36	0/484	0.79	1/653 (0.2%)
4	E	0.38	0/5311	0.66	8/7169 (0.1%)
4	G	0.37	0/5315	0.62	2/7175 (0.0%)
5	I	0.49	3/4322 (0.1%)	0.70	5/5853 (0.1%)
5	K	0.44	1/4683 (0.0%)	0.69	7/6338 (0.1%)
6	L	0.40	0/4697	0.69	5/6348 (0.1%)
7	S	0.35	0/3441	0.65	4/4661 (0.1%)
7	T	0.35	0/3441	0.65	4/4661 (0.1%)
7	U	0.35	0/3441	0.65	4/4661 (0.1%)
7	V	0.35	0/3441	0.65	4/4661 (0.1%)
7	W	0.35	0/3441	0.65	4/4661 (0.1%)
7	X	0.35	0/3441	0.65	4/4661 (0.1%)
7	Y	0.35	0/3441	0.65	4/4661 (0.1%)
7	Z	0.35	0/3441	0.65	4/4661 (0.1%)
All	All	0.39	7/70512 (0.0%)	0.66	77/95358 (0.1%)

Chiral center outliers are detected by calculating the chiral volume of a chiral center and verifying if the center is modelled as a planar moiety or with the opposite hand. A planarity outlier is detected by checking planarity of atoms in a peptide group, atoms in a mainchain group or atoms of a sidechain that are expected to be planar.

Mol	Chain	#Chirality outliers	#Planarity outliers
1	J	0	3
2	F	0	1
2	H	0	1

Continued on next page...

Continued from previous page...

Mol	Chain	#Chirality outliers	#Planarity outliers
3	b	0	1
3	k	0	1
3	m	0	1
4	E	0	3
4	G	0	3
5	I	0	3
5	K	0	2
6	L	0	1
All	All	0	20

All (7) bond length outliers are listed below:

Mol	Chain	Res	Type	Atoms	Z	Observed(Å)	Ideal(Å)
1	J	225	TRP	CD2-CE2	9.78	1.53	1.41
1	J	225	TRP	CZ3-CH2	8.23	1.53	1.40
5	I	361	TYR	CD2-CE2	-6.99	1.28	1.39
5	I	530	TYR	CD2-CE2	-6.02	1.30	1.39
5	I	124	TYR	CD1-CE1	-5.77	1.30	1.39
1	J	225	TRP	CG-CD2	5.50	1.52	1.43
5	K	651	TYR	CE2-CZ	-5.18	1.31	1.38

All (77) bond angle outliers are listed below:

Mol	Chain	Res	Type	Atoms	Z	Observed(°)	Ideal(°)
7	T	337	LEU	CA-CB-CG	12.16	143.28	115.30
7	U	337	LEU	CA-CB-CG	12.16	143.26	115.30
7	Y	337	LEU	CA-CB-CG	12.14	143.22	115.30
7	V	337	LEU	CA-CB-CG	12.14	143.21	115.30
7	S	337	LEU	CA-CB-CG	12.13	143.21	115.30
7	W	337	LEU	CA-CB-CG	12.13	143.20	115.30
7	X	337	LEU	CA-CB-CG	12.13	143.19	115.30
7	Z	337	LEU	CA-CB-CG	12.13	143.19	115.30
6	L	1800	LEU	CA-CB-CG	7.96	133.61	115.30
1	J	238	LEU	CA-CB-CG	7.71	133.04	115.30
7	V	195	LEU	CA-CB-CG	7.63	132.86	115.30
7	U	195	LEU	CA-CB-CG	7.63	132.85	115.30
7	S	195	LEU	CA-CB-CG	7.62	132.83	115.30
7	T	195	LEU	CA-CB-CG	7.61	132.81	115.30
7	W	195	LEU	CA-CB-CG	7.61	132.81	115.30
7	Z	195	LEU	CA-CB-CG	7.61	132.81	115.30
7	X	195	LEU	CA-CB-CG	7.61	132.80	115.30
7	Y	195	LEU	CA-CB-CG	7.60	132.78	115.30

Continued on next page...

Continued from previous page...

Mol	Chain	Res	Type	Atoms	Z	Observed(°)	Ideal(°)
6	L	1765	MET	CG-SD-CE	7.21	111.73	100.20
2	H	581	LEU	CA-CB-CG	7.20	131.87	115.30
1	l	121	PRO	N-CA-CB	6.93	111.61	103.30
2	j	97	LEU	CB-CG-CD2	-6.78	99.48	111.00
5	K	645	LEU	CA-CB-CG	6.66	130.61	115.30
2	F	621	LEU	CA-CB-CG	6.45	130.13	115.30
5	I	601	LEU	CA-CB-CG	6.42	130.06	115.30
5	I	475	TYR	CB-CG-CD2	-6.18	117.29	121.00
5	K	651	TYR	CA-CB-CG	6.15	125.09	113.40
4	E	655	LEU	CA-CB-CG	6.15	129.44	115.30
2	H	797	LEU	CA-CB-CG	6.14	129.42	115.30
4	G	324	LEU	CA-CB-CG	6.09	129.32	115.30
4	E	744	LEU	CA-CB-CG	6.03	129.16	115.30
1	l	130	PRO	N-CA-CB	6.01	110.51	103.30
6	L	287	LEU	CA-CB-CG	5.98	129.05	115.30
6	L	1800	LEU	CB-CG-CD2	-5.89	100.98	111.00
7	W	402	GLU	CA-CB-CG	5.89	126.36	113.40
7	X	402	GLU	CA-CB-CG	5.88	126.33	113.40
7	V	402	GLU	CA-CB-CG	5.87	126.32	113.40
7	S	402	GLU	CA-CB-CG	5.87	126.31	113.40
7	Y	402	GLU	CA-CB-CG	5.87	126.31	113.40
7	Z	402	GLU	CA-CB-CG	5.87	126.31	113.40
2	F	306	ARG	NE-CZ-NH1	5.87	123.23	120.30
7	T	402	GLU	CA-CB-CG	5.86	126.30	113.40
7	U	402	GLU	CA-CB-CG	5.86	126.28	113.40
2	F	873	LEU	CA-CB-CG	5.85	128.76	115.30
6	L	287	LEU	CB-CG-CD1	-5.78	101.18	111.00
4	E	356	LEU	CA-CB-CG	5.74	128.49	115.30
5	I	475	TYR	CA-CB-CG	5.73	124.28	113.40
7	W	12	GLN	CA-CB-CG	5.71	125.97	113.40
7	X	12	GLN	CA-CB-CG	5.71	125.96	113.40
7	Z	12	GLN	CA-CB-CG	5.71	125.96	113.40
7	S	12	GLN	CA-CB-CG	5.71	125.96	113.40
5	K	647	LEU	CB-CG-CD1	-5.71	101.30	111.00
7	T	12	GLN	CA-CB-CG	5.70	125.94	113.40
7	V	12	GLN	CA-CB-CG	5.70	125.93	113.40
7	Y	12	GLN	CA-CB-CG	5.70	125.93	113.40
7	U	12	GLN	CA-CB-CG	5.69	125.93	113.40
5	K	314	LEU	CA-CB-CG	5.65	128.30	115.30
1	J	237	HIS	C-N-CA	5.61	135.72	121.70
4	E	834	LEU	CB-CG-CD2	-5.59	101.49	111.00
2	H	701	LEU	CA-CB-CG	5.50	127.95	115.30

Continued on next page...

Continued from previous page...

Mol	Chain	Res	Type	Atoms	Z	Observed(°)	Ideal(°)
1	J	440	LEU	CA-CB-CG	5.46	127.86	115.30
2	H	581	LEU	CB-CG-CD1	5.44	120.24	111.00
3	b	35	LEU	CA-CB-CG	-5.44	102.79	115.30
3	k	35	LEU	CA-CB-CG	-5.43	102.81	115.30
3	m	35	LEU	CA-CB-CG	-5.42	102.82	115.30
5	I	361	TYR	CZ-CE2-CD2	5.35	124.62	119.80
4	G	833	LEU	CA-CB-CG	5.34	127.59	115.30
5	I	475	TYR	CB-CG-CD1	5.24	124.14	121.00
4	E	150	LEU	CA-CB-CG	5.23	127.32	115.30
2	H	600	ILE	CG1-CB-CG2	-5.20	99.97	111.40
5	K	199	GLN	C-N-CA	5.18	134.66	121.70
5	K	486	ARG	NE-CZ-NH2	5.16	122.88	120.30
2	F	287	LEU	CA-CB-CG	5.14	127.13	115.30
5	K	545	LEU	CA-CB-CG	5.12	127.07	115.30
4	E	687	LEU	CB-CG-CD2	-5.08	102.37	111.00
4	E	306	LEU	CA-CB-CG	5.07	126.96	115.30
4	E	655	LEU	CB-CG-CD1	-5.03	102.45	111.00

There are no chirality outliers.

All (20) planarity outliers are listed below:

Mol	Chain	Res	Type	Group
4	E	318	LEU	Peptide
4	E	424	ASN	Peptide
4	E	580	HIS	Peptide
2	F	626	LEU	Peptide
4	G	240	GLY	Peptide
4	G	580	HIS	Peptide
4	G	866	THR	Peptide
2	H	454	VAL	Peptide
5	I	407	ASP	Peptide
5	I	507	SER	Peptide
5	I	508	ASN	Peptide
1	J	235	SER	Peptide
1	J	236	LEU	Mainchain
1	J	256	LEU	Peptide
5	K	406	ASP	Peptide
5	K	408	ASP	Peptide
6	L	346	LEU	Peptide
3	b	35	LEU	Peptide
3	k	35	LEU	Peptide
3	m	35	LEU	Peptide

5.2 Too-close contacts [i](#)

In the following table, the Non-H and H(model) columns list the number of non-hydrogen atoms and hydrogen atoms in the chain respectively. The H(added) column lists the number of hydrogen atoms added and optimized by MolProbity. The Clashes column lists the number of clashes within the asymmetric unit, whereas Symm-Clashes lists symmetry-related clashes.

Mol	Chain	Non-H	H(model)	H(added)	Clashes	Symm-Clashes
1	J	4429	0	4482	31	0
1	l	847	0	789	0	0
2	F	4941	0	4935	54	0
2	H	4907	0	4896	54	0
2	a	933	0	953	0	0
2	j	803	0	831	0	0
3	b	484	0	512	0	0
3	k	484	0	512	0	0
3	m	484	0	512	0	0
4	E	5202	0	5241	63	0
4	G	5206	0	5230	48	0
5	I	4225	0	4259	38	0
5	K	4579	0	4586	49	0
6	L	4587	0	4636	47	0
7	S	3373	0	3325	48	0
7	T	3373	0	3325	49	0
7	U	3373	0	3325	44	0
7	V	3373	0	3325	48	0
7	W	3373	0	3325	50	0
7	X	3373	0	3325	48	0
7	Y	3373	0	3325	49	0
7	Z	3373	0	3325	47	0
All	All	69095	0	68974	716	0

The all-atom clashscore is defined as the number of clashes found per 1000 atoms (including hydrogen atoms). The all-atom clashscore for this structure is 5.

All (716) close contacts within the same asymmetric unit are listed below, sorted by their clash magnitude.

Atom-1	Atom-2	Interatomic distance (Å)	Clash overlap (Å)
7:Z:207:ASN:O	7:Z:211:ASN:HB2	1.65	0.96
7:W:207:ASN:O	7:W:211:ASN:HB2	1.65	0.96
7:X:207:ASN:O	7:X:211:ASN:HB2	1.65	0.96
7:Y:207:ASN:O	7:Y:211:ASN:HB2	1.65	0.96
7:S:207:ASN:O	7:S:211:ASN:HB2	1.65	0.95

Continued on next page...

Continued from previous page...

Atom-1	Atom-2	Interatomic distance (Å)	Clash overlap (Å)
7:T:207:ASN:O	7:T:211:ASN:HB2	1.66	0.95
7:V:207:ASN:O	7:V:211:ASN:HB2	1.65	0.95
7:W:56:ASP:HB3	7:X:295:ARG:HG2	1.47	0.95
5:I:361:TYR:HE2	5:I:475:TYR:HB3	1.33	0.94
7:U:207:ASN:O	7:U:211:ASN:HB2	1.65	0.93
1:J:242:LEU:HD13	1:J:305:LEU:H	1.52	0.73
1:J:832:LYS:HA	1:J:835:LYS:HG2	1.69	0.73
2:F:879:ARG:O	7:T:355:SER:OG	2.08	0.71
7:W:56:ASP:HA	7:X:295:ARG:HD3	1.73	0.70
5:I:361:TYR:CE2	5:I:475:TYR:HB3	2.22	0.70
2:H:669:ARG:HA	2:H:672:ARG:HE	1.56	0.70
6:L:409:ARG:HD3	6:L:412:HIS:HE1	1.56	0.70
5:K:199:GLN:O	5:K:200:HIS:ND1	2.25	0.69
2:H:724:PHE:HA	2:H:728:GLU:HG2	1.75	0.69
1:J:892:HIS:HE1	7:X:355:SER:HB2	1.59	0.67
6:L:1738:LYS:O	6:L:1742:GLN:NE2	2.24	0.67
5:I:357:ILE:O	5:I:361:TYR:HB3	1.95	0.66
2:F:692:ARG:NH1	7:T:196:THR:O	2.29	0.66
2:H:372:TYR:HA	2:H:375:LYS:HE2	1.78	0.66
6:L:568:TYR:HB2	6:L:1602:TRP:HE1	1.59	0.66
7:T:158:ASN:HD21	7:T:198:ASN:HD22	1.44	0.66
5:K:500:MET:HG2	7:Y:264:PRO:HB3	1.78	0.65
5:K:653:LYS:HG2	7:Y:353:PRO:HG3	1.78	0.65
7:V:158:ASN:HD21	7:V:198:ASN:HD22	1.44	0.65
4:G:359:LEU:HB3	4:G:380:THR:HG22	1.76	0.65
7:X:158:ASN:HD21	7:X:198:ASN:HD22	1.44	0.65
5:K:48:LEU:HD21	5:K:130:GLN:HA	1.78	0.65
7:U:158:ASN:HD21	7:U:198:ASN:HD22	1.44	0.65
7:V:274:THR:HG1	7:V:375:GLY:H	1.44	0.65
4:E:570:LYS:HD2	4:E:571:ASP:HB2	1.80	0.64
4:E:623:LYS:HG3	4:E:625:PRO:HD2	1.79	0.64
1:J:825:PHE:O	1:J:828:LEU:HB3	1.98	0.64
7:Z:158:ASN:HD21	7:Z:198:ASN:HD22	1.44	0.64
5:I:341:TRP:HD1	5:I:557:ILE:HD11	1.63	0.64
7:S:274:THR:HG1	7:S:375:GLY:H	1.44	0.64
2:H:431:TYR:HA	2:H:434:ILE:HG22	1.80	0.63
5:K:649:LEU:HB3	7:Y:341:ARG:HH21	1.63	0.63
7:W:158:ASN:HD21	7:W:198:ASN:HD22	1.44	0.63
5:I:42:LEU:HA	5:I:45:LEU:HD12	1.79	0.63
4:E:660:ILE:HG23	7:S:254:ILE:HD12	1.80	0.63
4:E:559:LEU:HD21	4:E:570:LYS:HD3	1.79	0.63

Continued on next page...

Continued from previous page...

Atom-1	Atom-2	Interatomic distance (Å)	Clash overlap (Å)
7:Y:158:ASN:HD21	7:Y:198:ASN:HD22	1.44	0.63
7:S:158:ASN:HD21	7:S:198:ASN:HD22	1.44	0.63
5:K:590:CYS:SG	5:K:591:HIS:N	2.70	0.63
6:L:1800:LEU:HD13	7:Z:341:ARG:HG3	1.80	0.63
6:L:350:CYS:SG	6:L:354:LYS:NZ	2.72	0.62
2:F:681:ARG:NH2	2:F:709:SER:OG	2.32	0.62
4:E:188:ILE:HG22	4:E:190:ASP:H	1.63	0.62
4:E:432:TYR:HB3	4:E:451:LEU:HD11	1.80	0.62
2:H:588:PRO:HA	2:H:633:THR:HA	1.81	0.62
7:X:274:THR:HG1	7:X:375:GLY:H	1.44	0.62
4:G:767:GLN:HA	4:G:770:LYS:HG2	1.80	0.62
1:J:412:LEU:HA	1:J:415:VAL:HG22	1.82	0.61
7:S:298:LEU:HD13	7:S:345:LEU:HD23	1.83	0.61
7:W:298:LEU:HD13	7:W:345:LEU:HD23	1.83	0.61
7:Z:274:THR:HG1	7:Z:375:GLY:H	1.49	0.61
2:H:651:VAL:HG23	2:H:748:ILE:HG12	1.83	0.61
7:U:298:LEU:HD13	7:U:345:LEU:HD23	1.82	0.61
2:F:721:TYR:O	2:F:725:GLU:HB2	2.01	0.61
5:I:41:VAL:HG13	5:I:44:ARG:HH22	1.65	0.61
7:Y:395:TYR:OH	7:Y:399:ARG:NH1	2.34	0.61
2:F:740:GLN:HE21	2:F:746:HIS:HE1	1.48	0.61
7:S:395:TYR:OH	7:S:399:ARG:NH1	2.34	0.61
2:F:763:LEU:HG	2:F:768:SER:HB2	1.82	0.60
7:V:298:LEU:HD13	7:V:345:LEU:HD23	1.82	0.60
7:Y:274:THR:HG1	7:Y:375:GLY:H	1.44	0.60
7:Z:395:TYR:OH	7:Z:399:ARG:NH1	2.34	0.60
4:E:517:LYS:HG3	4:E:521:LEU:HD12	1.83	0.60
4:E:530:HIS:HB3	4:E:558:ALA:HB1	1.83	0.60
2:F:620:ARG:HH11	2:F:644:VAL:HA	1.67	0.60
1:J:828:LEU:HG	1:J:832:LYS:HZ1	1.65	0.60
7:V:395:TYR:OH	7:V:399:ARG:NH1	2.34	0.60
2:H:869:SER:HB3	2:H:873:LEU:HG	1.84	0.60
7:T:395:TYR:OH	7:T:399:ARG:NH1	2.34	0.60
5:K:392:VAL:O	5:K:396:PHE:HB2	2.02	0.60
7:U:395:TYR:OH	7:U:399:ARG:NH1	2.34	0.60
7:W:395:TYR:OH	7:W:399:ARG:NH1	2.34	0.60
6:L:1675:TYR:HB2	6:L:1801:ARG:HG3	1.83	0.60
7:T:298:LEU:HD13	7:T:345:LEU:HD23	1.82	0.60
7:Y:298:LEU:HD13	7:Y:345:LEU:HD23	1.82	0.60
6:L:1686:CYS:HA	6:L:1689:ARG:HH21	1.67	0.60
7:X:395:TYR:OH	7:X:399:ARG:NH1	2.34	0.60

Continued on next page...

Continued from previous page...

Atom-1	Atom-2	Interatomic distance (Å)	Clash overlap (Å)
7:Z:298:LEU:HD13	7:Z:345:LEU:HD23	1.83	0.60
4:E:319:LEU:HD21	4:E:324:LEU:HD13	1.84	0.59
2:H:562:MET:HA	2:H:566:LEU:HD13	1.83	0.59
7:W:274:THR:HG1	7:W:375:GLY:H	1.48	0.59
7:X:298:LEU:HD13	7:X:345:LEU:HD23	1.83	0.59
2:F:684:HIS:HE2	2:F:704:CYS:HG	1.50	0.59
4:G:865:TYR:H	4:G:868:ARG:HH12	1.50	0.59
5:I:499:GLN:HA	7:W:264:PRO:HB3	1.84	0.59
5:I:143:ILE:HD11	5:I:156:THR:HG21	1.85	0.59
2:F:680:ILE:HD11	2:F:786:GLN:HE21	1.67	0.59
4:G:770:LYS:HZ3	4:G:771:LEU:HD23	1.68	0.59
6:L:1801:ARG:HH22	7:Z:337:LEU:HD21	1.68	0.59
7:U:274:THR:HG1	7:U:375:GLY:H	1.49	0.58
7:S:217:ARG:HG3	7:S:218:LEU:HG	1.85	0.58
6:L:1732:ILE:HG23	6:L:1772:PHE:HE1	1.68	0.58
7:U:217:ARG:HG3	7:U:218:LEU:HG	1.85	0.58
7:W:217:ARG:HG3	7:W:218:LEU:HG	1.85	0.58
7:Z:217:ARG:HG3	7:Z:218:LEU:HG	1.85	0.58
7:V:217:ARG:HG3	7:V:218:LEU:HG	1.85	0.58
7:X:217:ARG:HG3	7:X:218:LEU:HG	1.85	0.58
7:T:217:ARG:HG3	7:T:218:LEU:HG	1.85	0.58
7:T:274:THR:HG1	7:T:375:GLY:H	1.50	0.58
4:E:563:THR:OG1	7:S:45:THR:OG1	2.20	0.58
7:Y:217:ARG:HG3	7:Y:218:LEU:HG	1.85	0.58
7:V:185:PRO:O	7:V:189:LEU:HB2	2.05	0.57
7:X:185:PRO:O	7:X:189:LEU:HB2	2.05	0.57
7:Y:185:PRO:O	7:Y:189:LEU:HB2	2.05	0.57
2:H:600:ILE:HA	7:W:342:GLU:HG2	1.87	0.57
7:S:185:PRO:O	7:S:189:LEU:HB2	2.05	0.57
7:T:185:PRO:O	7:T:189:LEU:HB2	2.05	0.57
5:K:79:GLY:HA3	5:K:149:HIS:HA	1.86	0.57
7:Z:336:SER:HA	7:Z:339:ARG:HD2	1.87	0.57
5:I:586:ILE:HD13	5:I:622:GLN:HE21	1.70	0.57
7:U:185:PRO:O	7:U:189:LEU:HB2	2.05	0.57
1:J:493:ILE:HG12	1:J:548:MET:HA	1.87	0.56
2:F:364:LEU:HD22	2:F:370:TRP:HE1	1.70	0.56
5:K:197:LEU:HD13	6:L:510:LEU:HB3	1.86	0.56
4:G:527:PHE:O	4:G:531:PHE:HB2	2.05	0.56
7:W:185:PRO:O	7:W:189:LEU:HB2	2.05	0.56
7:W:336:SER:HA	7:W:339:ARG:HD2	1.87	0.56
7:X:336:SER:HA	7:X:339:ARG:HD2	1.87	0.56

Continued on next page...

Continued from previous page...

Atom-1	Atom-2	Interatomic distance (Å)	Clash overlap (Å)
4:E:655:LEU:HD22	4:E:687:LEU:HD13	1.87	0.56
4:G:528:PHE:HA	4:G:531:PHE:HB3	1.87	0.56
7:V:336:SER:HA	7:V:339:ARG:HD2	1.87	0.56
7:Z:185:PRO:O	7:Z:189:LEU:HB2	2.05	0.56
2:F:876:LEU:HD12	2:F:879:ARG:HD3	1.86	0.56
7:U:336:SER:HA	7:U:339:ARG:HD2	1.87	0.56
7:S:336:SER:HA	7:S:339:ARG:HD2	1.87	0.56
1:J:307:HIS:H	1:J:310:LEU:HD12	1.71	0.56
2:H:326:ALA:HB2	5:I:165:LEU:HG	1.89	0.55
4:E:356:LEU:HG	4:E:440:PRO:HB3	1.88	0.55
5:K:283:VAL:O	5:K:287:GLU:HB2	2.07	0.55
4:E:439:ILE:HG22	4:E:441:SER:H	1.71	0.55
7:Y:336:SER:HA	7:Y:339:ARG:HD2	1.87	0.55
7:T:336:SER:HA	7:T:339:ARG:HD2	1.87	0.55
2:H:635:TRP:HE3	2:H:672:ARG:HH11	1.55	0.55
4:E:530:HIS:CE1	7:S:47:ARG:HH21	2.25	0.55
5:I:38:GLU:O	5:I:41:VAL:HB	2.07	0.55
4:E:301:LYS:HG2	2:F:369:VAL:HG23	1.89	0.55
6:L:473:LEU:HA	6:L:476:LEU:HD13	1.89	0.54
4:G:527:PHE:O	4:G:531:PHE:CB	2.56	0.54
2:H:364:LEU:HB2	2:H:370:TRP:HE1	1.73	0.54
7:Z:183:VAL:HG13	7:Z:187:ASN:HD21	1.73	0.54
4:E:205:ILE:HG23	4:E:207:THR:H	1.72	0.54
2:F:751:HIS:O	2:F:754:PHE:HB3	2.07	0.54
4:G:353:GLY:HA2	4:G:356:LEU:HD12	1.89	0.54
2:F:568:LEU:HD22	2:F:667:LEU:HG	1.89	0.54
5:I:555:GLU:HA	5:I:558:ARG:HD2	1.89	0.54
7:V:119:PHE:HA	7:V:122:ILE:HD12	1.90	0.54
7:Y:119:PHE:HA	7:Y:122:ILE:HD12	1.90	0.54
7:X:119:PHE:HA	7:X:122:ILE:HD12	1.90	0.54
7:Y:183:VAL:HG13	7:Y:187:ASN:HD21	1.73	0.54
4:G:550:ARG:NH2	7:V:342:GLU:OE2	2.40	0.54
5:K:143:ILE:HD12	5:K:153:ILE:HG23	1.90	0.54
7:S:119:PHE:HA	7:S:122:ILE:HD12	1.90	0.54
7:W:183:VAL:HG13	7:W:187:ASN:HD21	1.73	0.54
5:K:204:PHE:HA	5:K:260:ARG:HB2	1.90	0.54
6:L:349:GLU:HG3	6:L:456:LEU:HG	1.90	0.53
7:T:183:VAL:HG13	7:T:187:ASN:HD21	1.73	0.53
4:G:302:GLU:HA	4:G:305:ILE:HD12	1.91	0.53
4:G:555:LEU:HD22	4:G:575:ILE:HD11	1.91	0.53
7:T:119:PHE:HA	7:T:122:ILE:HD12	1.90	0.53

Continued on next page...

Continued from previous page...

Atom-1	Atom-2	Interatomic distance (Å)	Clash overlap (Å)
7:X:183:VAL:HG13	7:X:187:ASN:HD21	1.73	0.53
6:L:1590:VAL:HG11	6:L:1733:PHE:HB3	1.90	0.53
7:V:3:ARG:HB2	7:V:133:GLU:HB2	1.91	0.53
7:V:183:VAL:HG13	7:V:187:ASN:HD21	1.73	0.53
7:S:3:ARG:HB2	7:S:133:GLU:HB2	1.91	0.53
7:U:183:VAL:HG13	7:U:187:ASN:HD21	1.73	0.53
2:H:325:CYS:HA	2:H:328:LEU:HD12	1.91	0.53
7:W:56:ASP:OD2	7:X:299:GLN:HG3	2.09	0.53
7:Z:3:ARG:HB2	7:Z:133:GLU:HB2	1.91	0.53
5:K:80:GLY:HA3	5:K:147:LYS:HA	1.90	0.53
4:E:253:ASP:HB3	4:E:256:ILE:HD12	1.91	0.53
6:L:507:GLN:O	6:L:511:HIS:HB2	2.08	0.53
7:T:3:ARG:HB2	7:T:133:GLU:HB2	1.91	0.53
2:H:297:LEU:HD21	2:H:375:LYS:HG2	1.91	0.53
6:L:409:ARG:HA	6:L:412:HIS:CE1	2.44	0.53
4:E:183:GLU:OE2	4:E:184:ARG:NH1	2.42	0.53
7:S:183:VAL:HG13	7:S:187:ASN:HD21	1.73	0.53
7:T:12:GLN:OE1	7:T:13:CYS:N	2.42	0.53
4:G:301:LYS:NZ	2:H:369:VAL:O	2.42	0.52
4:E:359:LEU:HD21	4:E:379:LEU:HB3	1.91	0.52
7:U:119:PHE:HA	7:U:122:ILE:HD12	1.90	0.52
7:Z:119:PHE:HA	7:Z:122:ILE:HD12	1.90	0.52
7:U:12:GLN:OE1	7:U:13:CYS:N	2.42	0.52
7:W:119:PHE:HA	7:W:122:ILE:HD12	1.90	0.52
1:J:210:PRO:HB2	1:J:213:ARG:HB3	1.91	0.52
7:V:12:GLN:OE1	7:V:13:CYS:N	2.43	0.52
7:Y:3:ARG:HB2	7:Y:133:GLU:HB2	1.91	0.52
4:E:684:GLN:NE2	7:S:259:SER:O	2.43	0.52
7:X:3:ARG:HB2	7:X:133:GLU:HB2	1.91	0.52
6:L:1597:ARG:O	6:L:1599:LYS:NZ	2.42	0.52
7:U:401:ARG:HD3	7:U:404:PHE:HE2	1.75	0.52
7:X:12:GLN:OE1	7:X:13:CYS:N	2.42	0.52
7:X:401:ARG:HD3	7:X:404:PHE:HE2	1.75	0.52
2:F:744:LEU:HD12	2:F:747:ILE:HD12	1.91	0.52
5:I:514:LYS:HG3	5:I:516:ARG:H	1.75	0.52
6:L:1612:CYS:SG	6:L:1705:HIS:NE2	2.77	0.52
7:V:401:ARG:HD3	7:V:404:PHE:HE2	1.75	0.52
7:W:3:ARG:HB2	7:W:133:GLU:HB2	1.91	0.52
2:F:883:ASN:ND2	7:T:346:ALA:O	2.43	0.52
5:K:651:TYR:CD2	7:Y:348:PHE:HB3	2.45	0.52
7:S:401:ARG:HD3	7:S:404:PHE:HE2	1.75	0.52

Continued on next page...

Continued from previous page...

Atom-1	Atom-2	Interatomic distance (Å)	Clash overlap (Å)
7:Z:12:GLN:OE1	7:Z:13:CYS:N	2.42	0.52
7:S:12:GLN:OE1	7:S:13:CYS:N	2.42	0.51
7:T:401:ARG:HD3	7:T:404:PHE:HE2	1.75	0.51
7:Y:12:GLN:OE1	7:Y:13:CYS:N	2.43	0.51
2:F:283:LEU:HD21	2:F:286:SER:HB2	1.91	0.51
6:L:1724:PRO:HA	6:L:1727:ASN:HB3	1.91	0.51
7:V:13:CYS:HB2	7:V:140:SER:HB2	1.93	0.51
7:Y:401:ARG:HD3	7:Y:404:PHE:HE2	1.75	0.51
7:Z:13:CYS:HB2	7:Z:140:SER:HB2	1.93	0.51
1:J:381:GLU:HA	1:J:384:LYS:HD2	1.92	0.51
7:W:13:CYS:HB2	7:W:140:SER:HB2	1.93	0.51
7:W:401:ARG:HD3	7:W:404:PHE:HE2	1.75	0.51
4:G:306:LEU:HA	4:G:309:GLN:HE21	1.75	0.51
7:Z:401:ARG:HD3	7:Z:404:PHE:HE2	1.75	0.51
1:J:953:ALA:HA	1:J:956:LYS:HG2	1.93	0.51
5:K:418:ILE:HD13	5:K:453:LEU:HD23	1.93	0.51
7:U:3:ARG:HB2	7:U:133:GLU:HB2	1.91	0.51
7:U:13:CYS:HB2	7:U:140:SER:HB2	1.93	0.51
7:X:13:CYS:HB2	7:X:140:SER:HB2	1.93	0.51
2:H:655:GLU:O	2:H:658:SER:OG	2.28	0.51
7:W:12:GLN:OE1	7:W:13:CYS:N	2.42	0.51
6:L:1677:ALA:HA	6:L:1681:LEU:HD12	1.93	0.51
4:E:444:GLN:HA	4:E:447:ALA:HB2	1.92	0.50
4:E:522:MET:HB2	7:S:248:TYR:CE1	2.45	0.50
2:H:270:ASN:H	2:H:273:ASN:HB2	1.75	0.50
2:H:868:SER:HB3	2:H:873:LEU:HD12	1.92	0.50
2:F:703:GLN:HE22	7:T:444:ILE:HG23	1.76	0.50
7:U:265:ARG:HH11	7:U:431:LEU:HD12	1.77	0.50
5:K:648:ARG:NH1	5:K:654:TYR:OH	2.43	0.50
7:Z:383:SER:O	7:Z:386:SER:OG	2.27	0.50
2:F:860:GLN:HA	2:F:863:VAL:HG12	1.94	0.50
5:K:380:LEU:HD22	5:K:453:LEU:HD21	1.94	0.50
7:X:265:ARG:HH11	7:X:431:LEU:HD12	1.77	0.50
2:F:717:GLN:HB3	2:F:879:ARG:HE	1.77	0.50
4:G:377:LEU:O	4:G:380:THR:OG1	2.30	0.50
7:V:265:ARG:HH11	7:V:431:LEU:HD12	1.77	0.50
7:Y:188:SER:O	7:Y:192:LEU:HB2	2.12	0.50
7:S:13:CYS:HB2	7:S:140:SER:HB2	1.93	0.50
7:V:188:SER:O	7:V:192:LEU:HB2	2.12	0.50
4:E:560:ARG:HA	4:E:565:ASN:HD22	1.77	0.50
2:H:477:MET:HG3	2:H:481:ARG:HE	1.77	0.50

Continued on next page...

Continued from previous page...

Atom-1	Atom-2	Interatomic distance (Å)	Clash overlap (Å)
2:H:666:PHE:HD2	2:H:667:LEU:HD12	1.76	0.50
5:I:553:ASP:O	5:I:556:SER:OG	2.27	0.50
1:J:829:LEU:HA	1:J:832:LYS:HG2	1.94	0.50
7:W:265:ARG:HH11	7:W:431:LEU:HD12	1.77	0.50
7:Y:13:CYS:HB2	7:Y:140:SER:HB2	1.93	0.50
4:G:709:LEU:HG	4:G:713:LEU:HD23	1.94	0.50
7:T:383:SER:O	7:T:386:SER:OG	2.27	0.50
7:Y:265:ARG:HH11	7:Y:431:LEU:HD12	1.77	0.50
4:G:456:TYR:HB3	4:G:499:LEU:HG	1.94	0.49
2:H:601:LEU:HD22	2:H:623:VAL:HG13	1.93	0.49
7:W:188:SER:O	7:W:192:LEU:HB2	2.12	0.49
4:G:824:LYS:HA	4:G:827:LYS:HE2	1.94	0.49
7:S:265:ARG:HH11	7:S:431:LEU:HD12	1.77	0.49
7:T:13:CYS:HB2	7:T:140:SER:HB2	1.93	0.49
7:T:188:SER:O	7:T:192:LEU:HB2	2.12	0.49
7:V:428:VAL:HA	7:V:431:LEU:HB2	1.94	0.49
7:X:428:VAL:HA	7:X:431:LEU:HB2	1.95	0.49
4:E:763:GLN:HG2	4:E:767:GLN:HE21	1.77	0.49
7:S:151:SER:HB2	7:S:194:ARG:HG2	1.95	0.49
7:S:428:VAL:HA	7:S:431:LEU:HB2	1.95	0.49
7:T:265:ARG:HH11	7:T:431:LEU:HD12	1.77	0.49
4:E:191:PHE:HD2	2:F:289:ASP:HB3	1.77	0.49
2:F:621:LEU:HB2	2:F:640:LEU:HD12	1.94	0.49
5:I:354:LEU:HA	5:I:357:ILE:HD12	1.93	0.49
7:S:389:GLU:O	7:S:393:ARG:N	2.45	0.49
7:T:428:VAL:HA	7:T:431:LEU:HB2	1.95	0.49
7:U:428:VAL:HA	7:U:431:LEU:HB2	1.95	0.49
7:V:151:SER:HB2	7:V:194:ARG:HG2	1.95	0.49
7:Z:265:ARG:HH11	7:Z:431:LEU:HD12	1.77	0.49
4:E:573:LEU:HD13	4:E:618:PHE:HB3	1.94	0.49
5:K:370:GLN:HB2	5:K:486:ARG:HE	1.78	0.49
6:L:1630:MET:SD	6:L:1630:MET:N	2.86	0.49
6:L:1680:ILE:HD11	6:L:1716:GLY:HA3	1.95	0.49
7:Z:151:SER:HB2	7:Z:194:ARG:HG2	1.95	0.49
7:T:389:GLU:O	7:T:393:ARG:N	2.45	0.49
7:Z:188:SER:O	7:Z:192:LEU:HB2	2.12	0.49
7:Z:389:GLU:O	7:Z:393:ARG:N	2.45	0.49
2:F:433:TRP:CD1	2:F:483:VAL:HG22	2.47	0.49
1:J:289:LEU:HA	1:J:294:VAL:HA	1.93	0.49
7:U:383:SER:O	7:U:386:SER:OG	2.27	0.49
7:V:383:SER:O	7:V:386:SER:OG	2.27	0.49

Continued on next page...

Continued from previous page...

Atom-1	Atom-2	Interatomic distance (Å)	Clash overlap (Å)
7:W:151:SER:HB2	7:W:194:ARG:HG2	1.95	0.49
4:E:682:LEU:HD21	4:E:826:ASP:HA	1.95	0.49
2:H:702:HIS:HD2	2:H:703:GLN:HE22	1.60	0.49
7:X:188:SER:O	7:X:192:LEU:HB2	2.12	0.49
2:H:333:ARG:HG2	5:I:124:TYR:CE1	2.48	0.48
7:W:428:VAL:HA	7:W:431:LEU:HB2	1.95	0.48
7:Y:151:SER:HB2	7:Y:194:ARG:HG2	1.95	0.48
7:Y:428:VAL:HA	7:Y:431:LEU:HB2	1.95	0.48
4:E:719:ILE:HA	4:E:722:VAL:HG22	1.95	0.48
1:J:942:LEU:HG	1:J:947:VAL:HG12	1.94	0.48
7:S:188:SER:O	7:S:192:LEU:HB2	2.12	0.48
7:X:151:SER:HB2	7:X:194:ARG:HG2	1.95	0.48
4:G:610:LEU:HB3	4:G:613:LEU:HD12	1.95	0.48
5:K:184:TYR:HB3	5:K:311:LEU:HD21	1.95	0.48
4:E:276:PHE:CE1	4:E:280:LYS:HG3	2.48	0.48
2:H:624:ARG:HB2	2:H:641:ASP:HB2	1.95	0.48
5:K:1:MET:SD	5:K:1:MET:N	2.86	0.48
7:U:419:ASP:O	7:U:423:THR:OG1	2.32	0.48
4:G:338:LEU:HD21	4:G:375:LEU:HD21	1.94	0.48
5:K:653:LYS:O	5:K:656:THR:OG1	2.28	0.48
6:L:284:GLU:HA	6:L:287:LEU:HB2	1.95	0.48
2:F:608:THR:OG1	2:F:609:ASN:N	2.47	0.48
2:F:807:GLU:HA	2:F:810:LYS:HE3	1.96	0.48
5:I:190:TRP:CE2	5:I:280:GLY:HA3	2.49	0.48
6:L:1800:LEU:HD21	7:Z:338:GLN:HA	1.95	0.48
7:U:188:SER:O	7:U:192:LEU:HB2	2.12	0.48
7:X:200:ASP:OD1	7:X:200:ASP:N	2.47	0.48
7:Y:200:ASP:OD1	7:Y:200:ASP:N	2.47	0.48
5:K:255:LYS:HZ3	5:K:258:SER:HB3	1.78	0.48
7:S:200:ASP:N	7:S:200:ASP:OD1	2.47	0.48
7:U:200:ASP:N	7:U:200:ASP:OD1	2.47	0.48
7:Y:389:GLU:O	7:Y:393:ARG:N	2.45	0.48
2:F:684:HIS:NE2	2:F:704:CYS:SG	2.84	0.47
6:L:1503:LEU:HG	6:L:1604:LEU:HD21	1.96	0.47
7:Z:419:ASP:O	7:Z:423:THR:OG1	2.32	0.47
2:H:776:ARG:HE	2:H:779:PHE:HD2	1.62	0.47
5:I:526:ASP:OD2	5:I:529:GLN:NE2	2.47	0.47
6:L:409:ARG:HD3	6:L:412:HIS:CE1	2.43	0.47
7:V:200:ASP:OD1	7:V:200:ASP:N	2.47	0.47
7:V:419:ASP:O	7:V:423:THR:OG1	2.32	0.47
7:Z:428:VAL:HA	7:Z:431:LEU:HB2	1.95	0.47

Continued on next page...

Continued from previous page...

Atom-1	Atom-2	Interatomic distance (Å)	Clash overlap (Å)
5:K:651:TYR:CG	7:Y:348:PHE:HB3	2.50	0.47
2:F:549:LEU:HB3	2:F:555:LEU:HD23	1.96	0.47
2:H:709:SER:HA	2:H:712:VAL:HG22	1.96	0.47
7:V:24:GLN:NE2	7:V:237:SER:OG	2.48	0.47
7:Y:24:GLN:NE2	7:Y:237:SER:OG	2.48	0.47
4:E:414:LEU:HD13	4:E:431:ARG:HA	1.97	0.47
5:K:358:LYS:NZ	5:K:359:ASP:OD1	2.47	0.47
7:U:151:SER:HB2	7:U:194:ARG:HG2	1.95	0.47
7:W:24:GLN:NE2	7:W:237:SER:OG	2.48	0.47
2:F:553:TYR:HB3	2:F:648:ILE:HD11	1.95	0.47
6:L:496:PRO:HB3	6:L:500:LYS:HG2	1.97	0.47
7:T:151:SER:HB2	7:T:194:ARG:HG2	1.95	0.47
7:W:200:ASP:N	7:W:200:ASP:OD1	2.47	0.47
7:W:419:ASP:O	7:W:423:THR:OG1	2.32	0.47
7:Z:24:GLN:NE2	7:Z:237:SER:OG	2.48	0.47
7:S:235:ILE:HA	7:S:376:LEU:HD21	1.97	0.47
7:V:235:ILE:HA	7:V:376:LEU:HD21	1.97	0.47
7:X:389:GLU:O	7:X:393:ARG:N	2.45	0.47
4:E:394:TRP:HB2	4:E:400:ILE:HG22	1.96	0.47
4:G:623:LYS:O	4:G:627:SER:N	2.48	0.47
5:I:2:ILE:HD12	5:I:111:PHE:HB3	1.96	0.47
5:I:498:LEU:HA	5:I:502:ARG:HB2	1.97	0.47
1:J:879:GLN:HG2	1:J:880:ILE:HD12	1.96	0.47
7:X:419:ASP:O	7:X:423:THR:OG1	2.32	0.47
7:Z:200:ASP:N	7:Z:200:ASP:OD1	2.47	0.47
2:H:568:LEU:HD23	2:H:574:ILE:HG21	1.97	0.47
7:S:419:ASP:O	7:S:423:THR:OG1	2.32	0.47
7:W:389:GLU:O	7:W:393:ARG:N	2.45	0.47
4:G:184:ARG:HD3	4:G:187:LEU:HD11	1.96	0.46
4:G:556:GLU:HB3	7:V:339:ARG:HE	1.80	0.46
4:G:815:VAL:HA	4:G:818:PHE:HB3	1.97	0.46
2:H:626:LEU:H	2:H:637:VAL:HG13	1.79	0.46
1:J:885:LEU:HD13	7:X:444:ILE:HG23	1.97	0.46
7:T:200:ASP:OD1	7:T:200:ASP:N	2.47	0.46
7:U:24:GLN:NE2	7:U:237:SER:OG	2.48	0.46
7:Y:419:ASP:O	7:Y:423:THR:OG1	2.32	0.46
4:G:158:ARG:HD2	4:G:162:ARG:HE	1.81	0.46
7:T:24:GLN:NE2	7:T:237:SER:OG	2.48	0.46
7:T:419:ASP:O	7:T:423:THR:OG1	2.32	0.46
7:X:24:GLN:NE2	7:X:237:SER:OG	2.48	0.46
1:J:215:TRP:HE1	6:L:319:ALA:HB2	1.79	0.46

Continued on next page...

Continued from previous page...

Atom-1	Atom-2	Interatomic distance (Å)	Clash overlap (Å)
7:W:343:ARG:HA	7:W:343:ARG:HD2	1.67	0.46
7:X:235:ILE:HA	7:X:376:LEU:HD21	1.97	0.46
4:E:685:ARG:HE	7:S:353:PRO:HG2	1.80	0.46
7:S:24:GLN:NE2	7:S:237:SER:OG	2.48	0.46
7:T:193:LYS:HB2	7:T:424:SER:HB2	1.98	0.46
2:F:717:GLN:HB3	2:F:879:ARG:HG3	1.98	0.46
4:G:578:MET:HG3	4:G:643:ARG:HD3	1.97	0.46
1:J:288:GLN:HE22	1:J:297:ARG:HB2	1.80	0.46
7:W:235:ILE:HA	7:W:376:LEU:HD21	1.97	0.46
7:U:193:LYS:HB2	7:U:424:SER:HB2	1.98	0.46
7:V:193:LYS:HB2	7:V:424:SER:HB2	1.98	0.46
7:V:343:ARG:HD2	7:V:343:ARG:HA	1.67	0.46
7:Y:235:ILE:HA	7:Y:376:LEU:HD21	1.97	0.46
4:E:266:VAL:HG21	4:E:328:ILE:HD13	1.97	0.46
7:V:389:GLU:O	7:V:393:ARG:N	2.45	0.46
7:W:351:TRP:CZ2	7:W:443:TYR:HB3	2.51	0.46
6:L:1653:VAL:HA	6:L:1656:ARG:NH1	2.31	0.46
4:G:165:GLN:HE22	4:G:173:HIS:H	1.64	0.46
5:I:45:LEU:HD21	5:I:123:ASN:HB2	1.98	0.46
5:I:366:GLY:HA2	5:I:486:ARG:HH22	1.80	0.46
5:K:647:LEU:HD11	7:Y:337:LEU:HD11	1.96	0.46
7:S:351:TRP:CZ2	7:S:443:TYR:HB3	2.51	0.46
7:T:235:ILE:HA	7:T:376:LEU:HD21	1.97	0.46
7:U:333:VAL:O	7:U:337:LEU:HB3	2.16	0.46
7:U:351:TRP:CZ2	7:U:443:TYR:HB3	2.51	0.46
7:Y:333:VAL:O	7:Y:337:LEU:HB3	2.16	0.46
7:Y:351:TRP:CZ2	7:Y:443:TYR:HB3	2.51	0.46
7:Z:343:ARG:HA	7:Z:343:ARG:HD2	1.67	0.46
7:T:351:TRP:CZ2	7:T:443:TYR:HB3	2.51	0.46
7:V:333:VAL:O	7:V:337:LEU:HB3	2.16	0.46
7:Z:193:LYS:HB2	7:Z:424:SER:HB2	1.98	0.46
4:E:341:LEU:O	4:E:345:VAL:HG22	2.16	0.45
4:E:657:SER:HA	4:E:660:ILE:HG12	1.98	0.45
5:K:496:TRP:O	5:K:500:MET:HB2	2.15	0.45
7:V:351:TRP:CZ2	7:V:443:TYR:HB3	2.51	0.45
7:W:333:VAL:O	7:W:337:LEU:HB3	2.16	0.45
7:X:351:TRP:CZ2	7:X:443:TYR:HB3	2.51	0.45
7:W:383:SER:O	7:W:386:SER:OG	2.27	0.45
7:X:193:LYS:HB2	7:X:424:SER:HB2	1.98	0.45
7:X:343:ARG:HA	7:X:343:ARG:HD2	1.67	0.45
2:F:320:VAL:HG13	2:F:396:LEU:HD23	1.99	0.45

Continued on next page...

Continued from previous page...

Atom-1	Atom-2	Interatomic distance (Å)	Clash overlap (Å)
2:H:879:ARG:NH2	7:V:355:SER:OG	2.49	0.45
6:L:1615:LYS:HB2	6:L:1709:LEU:HD21	1.97	0.45
7:T:333:VAL:O	7:T:337:LEU:HB3	2.16	0.45
7:U:56:ASP:OD2	7:V:276:LEU:N	2.44	0.45
7:Y:193:LYS:HB2	7:Y:424:SER:HB2	1.98	0.45
7:Z:333:VAL:O	7:Z:337:LEU:HB3	2.16	0.45
4:G:440:PRO:HD2	4:G:443:LEU:HD13	1.98	0.45
6:L:296:CYS:SG	6:L:297:TRP:N	2.89	0.45
7:S:193:LYS:HB2	7:S:424:SER:HB2	1.98	0.45
7:Z:235:ILE:HA	7:Z:376:LEU:HD21	1.97	0.45
2:F:433:TRP:HD1	2:F:483:VAL:HG22	1.82	0.45
7:S:333:VAL:O	7:S:337:LEU:HB3	2.16	0.45
7:Z:351:TRP:CZ2	7:Z:443:TYR:HB3	2.51	0.45
2:F:566:LEU:HD11	2:F:660:TYR:HB3	1.99	0.45
2:H:717:GLN:HE22	2:H:879:ARG:CZ	2.29	0.45
7:S:383:SER:O	7:S:386:SER:OG	2.27	0.45
4:E:695:TYR:OH	7:S:250:ASN:ND2	2.50	0.45
2:F:447:PHE:HE2	2:F:484:LEU:HB2	1.82	0.45
5:K:92:GLY:HA3	5:K:175:ILE:HG23	1.97	0.45
4:E:834:LEU:HD21	4:E:868:ARG:HB3	1.99	0.45
4:G:852:MET:SD	4:G:852:MET:N	2.81	0.45
6:L:464:LYS:HZ1	6:L:468:ARG:HB3	1.81	0.45
7:S:67:LEU:HD23	7:S:67:LEU:HA	1.85	0.45
7:Z:67:LEU:HD23	7:Z:67:LEU:HA	1.85	0.45
4:G:821:THR:HA	4:G:824:LYS:HG2	1.98	0.45
2:H:249:ALA:HA	2:H:252:ARG:HH11	1.81	0.45
2:H:455:LYS:H	2:H:455:LYS:HG2	1.48	0.45
5:K:143:ILE:HD13	5:K:148:ILE:HD12	1.99	0.45
7:X:333:VAL:O	7:X:337:LEU:HB3	2.16	0.45
4:E:248:VAL:HG11	4:E:257:ARG:HG3	1.99	0.45
5:I:491:GLU:HA	5:I:494:HIS:CD2	2.52	0.45
7:U:62:PRO:HD2	7:U:86:TYR:HB3	1.99	0.45
7:U:235:ILE:HA	7:U:376:LEU:HD21	1.97	0.45
7:V:318:ILE:HB	7:V:380:ASN:HB3	1.99	0.45
7:Y:318:ILE:HB	7:Y:380:ASN:HB3	1.99	0.45
2:F:672:ARG:O	2:F:676:ILE:HG12	2.16	0.44
4:G:632:ARG:O	4:G:636:THR:OG1	2.28	0.44
7:T:318:ILE:HB	7:T:380:ASN:HB3	1.99	0.44
7:U:389:GLU:O	7:U:393:ARG:N	2.45	0.44
7:W:193:LYS:HB2	7:W:424:SER:HB2	1.98	0.44
7:Z:62:PRO:HD2	7:Z:86:TYR:HB3	2.00	0.44

Continued on next page...

Continued from previous page...

Atom-1	Atom-2	Interatomic distance (Å)	Clash overlap (Å)
2:H:475:MET:HB3	2:H:475:MET:HE2	1.72	0.44
5:I:484:SER:HB3	5:I:587:LEU:HD11	2.00	0.44
6:L:1502:GLU:HG2	6:L:1503:LEU:HD22	1.98	0.44
6:L:1522:GLU:H	6:L:1525:GLN:HG2	1.82	0.44
7:T:62:PRO:HD2	7:T:86:TYR:HB3	2.00	0.44
7:U:349:ILE:HD11	7:U:351:TRP:CE2	2.53	0.44
2:F:268:MET:HG3	2:F:276:LYS:H	1.83	0.44
2:F:865:LEU:HD12	2:F:873:LEU:HD12	1.99	0.44
5:I:405:LEU:HD11	5:I:409:ASN:HB3	1.99	0.44
5:K:301:LYS:HZ1	5:K:336:VAL:HG12	1.82	0.44
5:K:546:HIS:O	5:K:550:SER:OG	2.26	0.44
6:L:294:ARG:HH21	6:L:308:GLU:HA	1.83	0.44
7:W:62:PRO:HD2	7:W:86:TYR:HB3	1.99	0.44
4:E:388:PHE:HA	4:E:391:LEU:HD12	2.00	0.44
2:H:493:LEU:HD13	2:H:545:LEU:HD22	2.00	0.44
2:H:737:LYS:HG3	2:H:750:ALA:HB1	1.99	0.44
5:K:184:TYR:HD1	5:K:315:LYS:HG3	1.82	0.44
5:K:345:VAL:HG23	5:K:346:GLU:HG3	1.99	0.44
6:L:1632:ALA:HB1	6:L:1740:ARG:HD2	1.98	0.44
7:S:343:ARG:HA	7:S:343:ARG:HD2	1.67	0.44
7:U:318:ILE:HB	7:U:380:ASN:HB3	1.99	0.44
7:W:318:ILE:HB	7:W:380:ASN:HB3	2.00	0.44
7:Y:343:ARG:HD2	7:Y:343:ARG:HA	1.67	0.44
4:E:221:LEU:HD22	4:E:263:ILE:HD11	1.99	0.44
4:E:522:MET:SD	7:S:248:TYR:OH	2.68	0.44
5:I:3:HIS:HB2	6:L:297:TRP:CZ2	2.53	0.44
5:I:610:ALA:O	5:I:613:SER:OG	2.30	0.44
5:K:152:GLN:NE2	5:K:262:GLU:O	2.51	0.44
7:T:160:ARG:HE	7:T:160:ARG:HB3	1.59	0.44
7:T:343:ARG:HD2	7:T:343:ARG:HA	1.67	0.44
7:V:349:ILE:HD11	7:V:351:TRP:CE2	2.53	0.44
7:X:349:ILE:HD11	7:X:351:TRP:CE2	2.53	0.44
7:Z:23:LYS:HB3	7:Z:23:LYS:HE3	1.83	0.44
4:E:341:LEU:HD13	4:E:341:LEU:HA	1.79	0.44
2:H:668:TRP:O	2:H:672:ARG:HG3	2.17	0.44
5:I:340:LEU:O	5:I:344:MET:HB2	2.18	0.44
5:K:132:LEU:O	5:K:135:SER:OG	2.33	0.44
6:L:1786:LEU:O	6:L:1792:GLN:NE2	2.44	0.44
2:F:554:SER:O	2:F:554:SER:OG	2.29	0.44
4:G:711:LYS:HB3	4:G:711:LYS:HE3	1.81	0.44
1:J:369:TYR:OH	5:K:127:ASP:O	2.34	0.44

Continued on next page...

Continued from previous page...

Atom-1	Atom-2	Interatomic distance (Å)	Clash overlap (Å)
2:F:254:ILE:HD12	2:F:257:VAL:HB	2.00	0.44
2:F:451:ASP:H	2:F:463:LYS:HA	1.82	0.44
5:I:279:VAL:HG13	5:I:336:VAL:HG11	1.99	0.44
7:W:349:ILE:HD11	7:W:351:TRP:CE2	2.53	0.44
7:Y:349:ILE:HD11	7:Y:351:TRP:CE2	2.53	0.44
2:F:692:ARG:NH1	7:T:265:ARG:HG2	2.33	0.44
5:I:498:LEU:HD21	7:W:264:PRO:HD3	1.99	0.44
1:J:242:LEU:HA	1:J:245:VAL:HG22	1.99	0.44
7:T:349:ILE:HD11	7:T:351:TRP:CE2	2.53	0.44
7:Z:349:ILE:HD11	7:Z:351:TRP:CE2	2.53	0.44
4:E:518:ARG:HG2	4:E:519:TYR:CD1	2.53	0.43
5:I:157:VAL:HG13	5:I:172:LEU:HG	2.00	0.43
7:S:349:ILE:HD11	7:S:351:TRP:CE2	2.53	0.43
7:T:23:LYS:HB3	7:T:23:LYS:HE3	1.83	0.43
7:Z:318:ILE:HB	7:Z:380:ASN:HB3	1.99	0.43
4:E:641:LEU:HD23	4:E:739:LEU:HD23	2.00	0.43
7:W:3:ARG:HE	7:W:3:ARG:HB3	1.73	0.43
7:X:318:ILE:HB	7:X:380:ASN:HB3	1.99	0.43
4:E:581:ASP:HB3	4:E:582:LEU:H	1.57	0.43
5:I:578:PRO:HA	5:I:581:HIS:CD2	2.53	0.43
7:T:231:LEU:O	7:T:234:THR:OG1	2.32	0.43
7:U:3:ARG:HE	7:U:3:ARG:HB3	1.73	0.43
4:E:391:LEU:HG	4:E:407:PHE:HE1	1.84	0.43
2:F:339:LEU:HA	2:F:342:LEU:HD12	2.00	0.43
2:F:740:GLN:HE21	2:F:746:HIS:CE1	2.31	0.43
6:L:1607:VAL:HA	6:L:1702:GLN:HG2	2.00	0.43
7:S:318:ILE:HB	7:S:380:ASN:HB3	1.99	0.43
1:J:684:GLU:HG2	1:J:688:ARG:HB2	2.00	0.43
2:H:334:GLU:H	2:H:334:GLU:HG3	1.64	0.43
7:V:115:HIS:NE2	7:V:116:GLU:OE2	2.52	0.43
7:Z:265:ARG:HH12	7:Z:430:GLN:HB2	1.84	0.43
4:E:163:ASP:OD1	4:E:163:ASP:N	2.51	0.43
4:E:308:SER:O	4:E:311:GLU:HG2	2.18	0.43
2:F:876:LEU:O	2:F:879:ARG:HG2	2.19	0.43
4:G:271:SER:O	4:G:274:THR:HB	2.19	0.43
4:G:635:LEU:HG	4:G:639:GLN:HE21	1.84	0.43
7:X:62:PRO:HD2	7:X:86:TYR:HB3	2.00	0.43
7:Y:115:HIS:NE2	7:Y:116:GLU:OE2	2.52	0.43
2:F:338:LEU:HD11	2:F:377:ARG:HH22	1.83	0.43
5:K:646:LEU:HB3	7:Y:341:ARG:HD2	2.01	0.43
7:T:265:ARG:HH12	7:T:430:GLN:HB2	1.84	0.43

Continued on next page...

Continued from previous page...

Atom-1	Atom-2	Interatomic distance (Å)	Clash overlap (Å)
7:U:115:HIS:NE2	7:U:116:GLU:OE2	2.52	0.43
7:U:265:ARG:HH12	7:U:430:GLN:HB2	1.84	0.43
7:V:62:PRO:HD2	7:V:86:TYR:HB3	2.00	0.43
1:J:898:HIS:HA	1:J:901:ILE:HG12	2.00	0.43
5:K:17:PHE:HB3	5:K:25:LEU:HD22	2.01	0.43
6:L:1522:GLU:HA	6:L:1525:GLN:HB2	2.01	0.43
7:S:62:PRO:HD2	7:S:86:TYR:HB3	1.99	0.43
7:X:23:LYS:HB3	7:X:23:LYS:HE3	1.83	0.43
4:E:554:LEU:HD13	4:E:557:LEU:HD21	1.99	0.43
2:H:581:LEU:HD13	2:H:600:ILE:HD11	2.01	0.43
1:J:739:TYR:CG	1:J:832:LYS:HD3	2.54	0.43
7:W:265:ARG:HH12	7:W:430:GLN:HB2	1.84	0.43
2:F:433:TRP:HZ2	2:F:484:LEU:HD12	1.84	0.42
2:H:794:ARG:HH22	2:H:797:LEU:HD11	1.83	0.42
7:V:52:PHE:HB3	7:V:60:TYR:HB3	2.01	0.42
7:V:231:LEU:O	7:V:234:THR:OG1	2.32	0.42
7:Z:52:PHE:HB3	7:Z:60:TYR:HB3	2.01	0.42
5:K:311:LEU:HA	5:K:314:LEU:HG	2.00	0.42
7:S:115:HIS:NE2	7:S:116:GLU:OE2	2.52	0.42
7:X:52:PHE:HB3	7:X:60:TYR:HB3	2.01	0.42
7:X:265:ARG:HH12	7:X:430:GLN:HB2	1.84	0.42
7:Z:231:LEU:O	7:Z:234:THR:OG1	2.32	0.42
1:J:312:SER:O	1:J:315:GLU:HG2	2.19	0.42
7:T:52:PHE:HB3	7:T:60:TYR:HB3	2.01	0.42
2:H:330:GLN:HE22	2:H:421:LEU:HD11	1.85	0.42
5:K:166:PRO:O	5:K:170:SER:OG	2.29	0.42
7:S:52:PHE:HB3	7:S:60:TYR:HB3	2.01	0.42
7:W:356:ILE:HD13	7:W:356:ILE:HA	1.83	0.42
7:Y:62:PRO:HD2	7:Y:86:TYR:HB3	2.00	0.42
5:I:21:LYS:HD3	5:I:21:LYS:HA	1.77	0.42
5:K:365:ARG:NH1	5:K:367:GLU:OE1	2.51	0.42
6:L:1555:SER:HA	6:L:1558:LEU:HD12	2.02	0.42
7:S:274:THR:HG23	7:S:297:LEU:HB2	2.02	0.42
7:S:415:LYS:HG3	7:S:418:PHE:H	1.84	0.42
7:T:115:HIS:NE2	7:T:116:GLU:OE2	2.52	0.42
7:U:415:LYS:HG3	7:U:418:PHE:H	1.84	0.42
7:V:274:THR:HG23	7:V:297:LEU:HB2	2.02	0.42
7:V:415:LYS:HG3	7:V:418:PHE:H	1.84	0.42
7:X:115:HIS:NE2	7:X:116:GLU:OE2	2.52	0.42
7:Y:3:ARG:HE	7:Y:3:ARG:HB3	1.73	0.42
7:Y:265:ARG:HH12	7:Y:430:GLN:HB2	1.84	0.42

Continued on next page...

Continued from previous page...

Atom-1	Atom-2	Interatomic distance (Å)	Clash overlap (Å)
7:Z:274:THR:HG23	7:Z:297:LEU:HB2	2.02	0.42
7:Z:415:LYS:HG3	7:Z:418:PHE:H	1.84	0.42
4:E:548:PRO:HB2	2:F:874:ARG:HH22	1.85	0.42
4:G:675:TRP:HB2	4:G:676:PHE:H	1.65	0.42
4:G:684:GLN:HE21	4:G:688:ASN:HD21	1.68	0.42
2:H:635:TRP:CE3	2:H:672:ARG:HD3	2.54	0.42
7:W:115:HIS:NE2	7:W:116:GLU:OE2	2.52	0.42
7:X:274:THR:HG23	7:X:297:LEU:HB2	2.02	0.42
7:X:415:LYS:HG3	7:X:418:PHE:H	1.84	0.42
4:E:637:ARG:HA	4:E:640:MET:HG2	2.02	0.42
4:G:439:ILE:HA	4:G:440:PRO:HD3	1.89	0.42
7:U:343:ARG:HD2	7:U:343:ARG:HA	1.67	0.42
7:V:67:LEU:HD23	7:V:67:LEU:HA	1.85	0.42
7:V:265:ARG:HH12	7:V:430:GLN:HB2	1.84	0.42
5:K:1:MET:N	6:L:320:PHE:HB2	2.35	0.42
7:Y:415:LYS:HG3	7:Y:418:PHE:H	1.85	0.42
7:Z:115:HIS:NE2	7:Z:116:GLU:OE2	2.52	0.42
4:E:509:LEU:HD13	4:E:626:LEU:HD22	2.02	0.42
6:L:1607:VAL:HG13	6:L:1702:GLN:HG2	2.00	0.42
6:L:1767:GLN:HE21	6:L:1771:THR:HG23	1.84	0.42
7:W:23:LYS:HB3	7:W:23:LYS:HE3	1.83	0.42
2:F:677:LEU:HD12	2:F:680:ILE:HD12	2.02	0.42
4:G:362:ARG:HD2	4:G:362:ARG:HA	1.85	0.42
4:G:473:LYS:HG3	4:G:487:GLN:NE2	2.35	0.42
2:H:603:THR:OG1	7:W:342:GLU:HB3	2.19	0.42
7:U:231:LEU:O	7:U:234:THR:OG1	2.32	0.42
2:F:255:LEU:HD22	2:F:346:LEU:HD13	2.02	0.41
2:F:743:ASP:N	2:F:743:ASP:OD1	2.53	0.41
1:J:376:LYS:HD3	5:K:124:TYR:HB2	2.02	0.41
6:L:428:VAL:HG12	6:L:531:PRO:HD2	2.02	0.41
7:S:265:ARG:HH12	7:S:430:GLN:HB2	1.84	0.41
7:T:415:LYS:HG3	7:T:418:PHE:H	1.84	0.41
7:U:274:THR:HG23	7:U:297:LEU:HB2	2.02	0.41
7:X:56:ASP:OD1	7:X:56:ASP:N	2.53	0.41
2:H:664:PHE:O	2:H:668:TRP:HB2	2.20	0.41
2:H:722:ILE:HA	2:H:726:VAL:HG22	2.02	0.41
7:X:383:SER:O	7:X:386:SER:OG	2.27	0.41
4:E:306:LEU:O	4:E:310:LEU:HG	2.19	0.41
4:G:555:LEU:HD11	4:G:573:LEU:HD11	2.01	0.41
4:G:650:HIS:HD2	4:G:653:ARG:HH11	1.69	0.41
2:H:538:TYR:O	2:H:542:SER:OG	2.28	0.41

Continued on next page...

Continued from previous page...

Atom-1	Atom-2	Interatomic distance (Å)	Clash overlap (Å)
5:I:127:ASP:HA	5:I:130:GLN:HG3	2.02	0.41
1:J:287:PHE:H	1:J:296:VAL:HA	1.86	0.41
7:T:252:ASP:OD1	7:T:252:ASP:N	2.47	0.41
4:E:399:ILE:HD12	4:E:401:HIS:HE1	1.85	0.41
1:J:271:ILE:HD13	1:J:393:ILE:HG22	2.03	0.41
5:K:255:LYS:HG3	5:K:256:GLN:H	1.85	0.41
7:S:56:ASP:OD1	7:S:56:ASP:N	2.53	0.41
7:T:56:ASP:OD1	7:T:56:ASP:N	2.53	0.41
7:W:56:ASP:OD1	7:W:56:ASP:N	2.53	0.41
7:X:231:LEU:O	7:X:234:THR:OG1	2.32	0.41
4:E:168:LYS:HD2	4:E:168:LYS:HA	1.94	0.41
4:E:756:VAL:HA	4:E:759:THR:HG22	2.01	0.41
5:I:487:ARG:HE	5:I:488:VAL:HG13	1.85	0.41
5:K:48:LEU:HD13	5:K:126:LEU:HG	2.03	0.41
7:W:52:PHE:HB3	7:W:60:TYR:HB3	2.01	0.41
4:E:244:ARG:NH1	4:E:271:SER:OG	2.54	0.41
4:E:280:LYS:HB3	4:E:289:ASN:ND2	2.35	0.41
2:F:305:ARG:NE	2:F:306:ARG:HH22	2.18	0.41
4:G:861:PHE:CD2	7:U:348:PHE:HD1	2.39	0.41
5:K:370:GLN:HB2	5:K:486:ARG:HH21	1.84	0.41
7:S:356:ILE:HD13	7:S:356:ILE:HA	1.83	0.41
7:U:52:PHE:HB3	7:U:60:TYR:HB3	2.01	0.41
7:W:274:THR:HG23	7:W:297:LEU:HB2	2.02	0.41
7:Y:56:ASP:OD1	7:Y:56:ASP:N	2.53	0.41
7:Y:274:THR:HG23	7:Y:297:LEU:HB2	2.02	0.41
2:F:568:LEU:HG	2:F:574:ILE:HG13	2.03	0.41
4:G:257:ARG:O	4:G:261:HIS:ND1	2.48	0.41
4:G:623:LYS:H	4:G:626:LEU:HB2	1.86	0.41
2:H:783:ILE:HD12	2:H:783:ILE:HA	1.92	0.41
5:I:25:LEU:HD11	5:I:53:ILE:HD12	2.02	0.41
5:I:582:CYS:O	5:I:586:ILE:HG12	2.21	0.41
1:J:892:HIS:CE1	7:X:355:SER:HB2	2.47	0.41
7:T:274:THR:HG23	7:T:297:LEU:HB2	2.02	0.41
7:Z:73:VAL:O	7:Z:76:SER:OG	2.34	0.41
2:H:526:LEU:HD23	2:H:526:LEU:HA	1.88	0.41
2:H:677:LEU:HG	2:H:712:VAL:HG12	2.02	0.41
5:I:345:VAL:HG23	5:I:346:GLU:HG3	2.03	0.41
7:V:262:PRO:HG3	7:V:318:ILE:HG21	2.03	0.41
7:W:57:ASP:HB3	7:W:59:HIS:CE1	2.56	0.41
7:Y:399:ARG:HD2	7:Y:399:ARG:HA	1.91	0.41
4:E:354:SER:O	4:E:357:SER:OG	2.33	0.41

Continued on next page...

Continued from previous page...

Atom-1	Atom-2	Interatomic distance (Å)	Clash overlap (Å)
2:F:720:TYR:OH	7:T:250:ASN:ND2	2.54	0.41
2:F:887:LYS:HE2	2:F:887:LYS:HB3	1.60	0.41
4:G:631:ASN:HD21	4:G:633:LYS:HG2	1.86	0.41
2:H:726:VAL:HG12	2:H:761:ARG:HB3	2.03	0.41
5:K:530:TYR:O	5:K:534:VAL:HG23	2.21	0.41
6:L:434:SER:HB3	6:L:437:ARG:HH21	1.86	0.41
7:S:424:SER:O	7:S:428:VAL:HG13	2.21	0.41
7:U:57:ASP:HB3	7:U:59:HIS:CE1	2.56	0.41
7:U:262:PRO:HG3	7:U:318:ILE:HG21	2.03	0.41
7:V:56:ASP:OD1	7:V:56:ASP:N	2.53	0.41
7:V:424:SER:O	7:V:428:VAL:HG13	2.21	0.41
7:X:424:SER:O	7:X:428:VAL:HG13	2.21	0.41
7:Y:231:LEU:O	7:Y:234:THR:OG1	2.32	0.41
7:Y:383:SER:O	7:Y:386:SER:OG	2.27	0.41
7:Z:56:ASP:OD1	7:Z:56:ASP:N	2.53	0.41
4:E:330:PRO:HA	4:E:333:ARG:HE	1.85	0.41
4:G:395:ILE:HD11	4:G:450:ILE:HG23	2.03	0.41
2:H:758:ILE:HA	2:H:758:ILE:HD13	1.85	0.41
1:J:831:ILE:HG21	1:J:901:ILE:HD11	2.02	0.41
5:K:577:LYS:O	5:K:581:HIS:HB2	2.21	0.41
7:T:57:ASP:HB3	7:T:59:HIS:CE1	2.56	0.41
2:F:605:VAL:HG13	2:F:610:ALA:HB3	2.03	0.40
5:K:141:GLU:O	5:K:145:SER:OG	2.30	0.40
5:K:528:LEU:HD23	5:K:528:LEU:HA	1.80	0.40
7:W:180:ASP:HB3	7:W:181:VAL:H	1.74	0.40
7:Z:57:ASP:HB3	7:Z:59:HIS:CE1	2.56	0.40
7:Z:262:PRO:HG3	7:Z:318:ILE:HG21	2.03	0.40
4:G:398:GLY:HA3	4:G:461:ARG:HH22	1.85	0.40
2:H:594:GLN:HG3	2:H:623:VAL:HG23	2.03	0.40
1:J:283:LYS:HA	1:J:283:LYS:HD2	1.85	0.40
7:T:424:SER:O	7:T:428:VAL:HG13	2.21	0.40
7:W:424:SER:O	7:W:428:VAL:HG13	2.21	0.40
7:Y:24:GLN:HG2	7:Y:25:LEU:HD12	2.04	0.40
7:Y:52:PHE:HB3	7:Y:60:TYR:HB3	2.01	0.40
2:H:300:LEU:HB2	2:H:378:LEU:HD21	2.04	0.40
2:H:427:LEU:HA	2:H:430:LEU:HG	2.02	0.40
6:L:554:ILE:HD13	6:L:596:TYR:HB2	2.04	0.40
7:V:23:LYS:HB3	7:V:23:LYS:HE3	1.83	0.40
7:W:415:LYS:HG3	7:W:418:PHE:H	1.85	0.40
7:X:3:ARG:HE	7:X:3:ARG:HB3	1.73	0.40
4:E:192:LEU:HA	4:E:192:LEU:HD13	1.91	0.40

Continued on next page...

Continued from previous page...

Atom-1	Atom-2	Interatomic distance (Å)	Clash overlap (Å)
4:G:747:VAL:H	4:G:747:VAL:HG22	1.69	0.40
2:H:446:PHE:O	2:H:467:ARG:NH1	2.54	0.40
7:U:56:ASP:OD1	7:U:56:ASP:N	2.53	0.40
7:U:424:SER:O	7:U:428:VAL:HG13	2.21	0.40
7:V:160:ARG:HE	7:V:160:ARG:HB3	1.59	0.40
7:V:395:TYR:O	7:V:399:ARG:N	2.52	0.40
7:Y:424:SER:O	7:Y:428:VAL:HG13	2.21	0.40
7:Z:24:GLN:HG2	7:Z:25:LEU:HD12	2.04	0.40
4:E:321:LEU:HD12	4:E:321:LEU:HA	1.91	0.40
4:E:655:LEU:HD11	4:E:686:MET:HG3	2.03	0.40
4:G:257:ARG:HG2	4:G:261:HIS:CE1	2.56	0.40
1:J:828:LEU:HG	1:J:832:LYS:NZ	2.35	0.40
6:L:1739:PHE:HA	6:L:1765:MET:SD	2.60	0.40
7:X:262:PRO:HG3	7:X:318:ILE:HG21	2.03	0.40

There are no symmetry-related clashes.

5.3 Torsion angles [i](#)

5.3.1 Protein backbone [i](#)

In the following table, the Percentiles column shows the percent Ramachandran outliers of the chain as a percentile score with respect to all PDB entries followed by that with respect to all EM entries.

The Analysed column shows the number of residues for which the backbone conformation was analysed, and the total number of residues.

Mol	Chain	Analysed	Favoured	Allowed	Outliers	Percentiles	
1	J	506/1024 (49%)	472 (93%)	30 (6%)	4 (1%)	19	60
1	l	104/1024 (10%)	94 (90%)	7 (7%)	3 (3%)	4	29
2	F	591/907 (65%)	555 (94%)	36 (6%)	0	100	100
2	H	584/907 (64%)	565 (97%)	18 (3%)	1 (0%)	47	81
2	a	112/907 (12%)	106 (95%)	6 (5%)	0	100	100
2	j	97/907 (11%)	95 (98%)	2 (2%)	0	100	100
3	b	63/82 (77%)	60 (95%)	3 (5%)	0	100	100
3	k	63/82 (77%)	60 (95%)	3 (5%)	0	100	100
3	m	63/82 (77%)	60 (95%)	3 (5%)	0	100	100

Continued on next page...

Continued from previous page...

Mol	Chain	Analysed	Favoured	Allowed	Outliers	Percentiles	
4	E	626/902 (69%)	590 (94%)	34 (5%)	2 (0%)	41	77
4	G	628/902 (70%)	593 (94%)	33 (5%)	2 (0%)	41	77
5	I	511/667 (77%)	481 (94%)	27 (5%)	3 (1%)	25	66
5	K	548/667 (82%)	536 (98%)	11 (2%)	1 (0%)	47	81
6	L	540/1819 (30%)	505 (94%)	33 (6%)	2 (0%)	34	72
7	S	408/451 (90%)	392 (96%)	16 (4%)	0	100	100
7	T	408/451 (90%)	392 (96%)	16 (4%)	0	100	100
7	U	408/451 (90%)	392 (96%)	16 (4%)	0	100	100
7	V	408/451 (90%)	392 (96%)	16 (4%)	0	100	100
7	W	408/451 (90%)	392 (96%)	16 (4%)	0	100	100
7	X	408/451 (90%)	392 (96%)	16 (4%)	0	100	100
7	Y	408/451 (90%)	392 (96%)	16 (4%)	0	100	100
7	Z	408/451 (90%)	392 (96%)	16 (4%)	0	100	100
All	All	8300/14487 (57%)	7908 (95%)	374 (4%)	18 (0%)	50	81

All (18) Ramachandran outliers are listed below:

Mol	Chain	Res	Type
1	l	120	SER
1	l	121	PRO
4	E	581	ASP
2	H	455	LYS
5	I	408	ASP
5	I	508	ASN
1	J	236	LEU
1	J	238	LEU
1	J	257	TYR
5	K	409	ASN
6	L	308	GLU
4	G	241	ARG
5	I	405	LEU
1	l	129	THR
4	E	582	LEU
4	G	864	PHE
6	L	307	ARG
1	J	258	VAL

5.3.2 Protein sidechains [i](#)

In the following table, the Percentiles column shows the percent sidechain outliers of the chain as a percentile score with respect to all PDB entries followed by that with respect to all EM entries.

The Analysed column shows the number of residues for which the sidechain conformation was analysed, and the total number of residues.

Mol	Chain	Analysed	Rotameric	Outliers	Percentiles	
1	J	498/933 (53%)	496 (100%)	2 (0%)	91	94
1	l	84/933 (9%)	83 (99%)	1 (1%)	71	83
2	F	542/798 (68%)	540 (100%)	2 (0%)	91	94
2	H	539/798 (68%)	537 (100%)	2 (0%)	91	94
2	a	101/798 (13%)	100 (99%)	1 (1%)	76	86
2	j	88/798 (11%)	88 (100%)	0	100	100
3	b	53/62 (86%)	43 (81%)	10 (19%)	1	8
3	k	53/62 (86%)	43 (81%)	10 (19%)	1	8
3	m	53/62 (86%)	43 (81%)	10 (19%)	1	8
4	E	574/791 (73%)	573 (100%)	1 (0%)	93	96
4	G	572/791 (72%)	567 (99%)	5 (1%)	78	87
5	I	472/594 (80%)	468 (99%)	4 (1%)	81	89
5	K	509/594 (86%)	505 (99%)	4 (1%)	81	89
6	L	501/1546 (32%)	496 (99%)	5 (1%)	76	86
7	S	376/400 (94%)	326 (87%)	50 (13%)	4	18
7	T	376/400 (94%)	326 (87%)	50 (13%)	4	18
7	U	376/400 (94%)	326 (87%)	50 (13%)	4	18
7	V	376/400 (94%)	326 (87%)	50 (13%)	4	18
7	W	376/400 (94%)	326 (87%)	50 (13%)	4	18
7	X	376/400 (94%)	326 (87%)	50 (13%)	4	18
7	Y	376/400 (94%)	326 (87%)	50 (13%)	4	18
7	Z	376/400 (94%)	326 (87%)	50 (13%)	4	18
All	All	7647/12760 (60%)	7190 (94%)	457 (6%)	23	44

All (457) residues with a non-rotameric sidechain are listed below:

Mol	Chain	Res	Type
1	l	85	LYS
3	m	24	THR
3	m	35	LEU
3	m	37	THR
3	m	39	LEU
3	m	44	LEU
3	m	45	SER
3	m	51	CYS
3	m	62	SER
3	m	71	THR
3	m	74	LEU
3	k	24	THR
3	k	35	LEU
3	k	37	THR
3	k	39	LEU
3	k	44	LEU
3	k	45	SER
3	k	51	CYS
3	k	62	SER
3	k	71	THR
3	k	74	LEU
4	E	570	LYS
2	F	290	THR
2	F	293	ARG
4	G	632	ARG
4	G	675	TRP
4	G	750	LYS
4	G	852	MET
4	G	862	ASN
2	H	551	LYS
2	H	656	CYS
5	I	104	LEU
5	I	179	CYS
5	I	475	TYR
5	I	498	LEU
1	J	238	LEU
1	J	372	PHE
5	K	4	GLU
5	K	35	HIS
5	K	639	ASN
5	K	651	TYR
6	L	294	ARG
6	L	320	PHE

Continued on next page...

Continued from previous page...

Mol	Chain	Res	Type
6	L	465	LYS
6	L	1553	VAL
6	L	1800	LEU
3	b	24	THR
3	b	35	LEU
3	b	37	THR
3	b	39	LEU
3	b	44	LEU
3	b	45	SER
3	b	51	CYS
3	b	62	SER
3	b	71	THR
3	b	74	LEU
2	a	50	ASP
7	S	7	THR
7	S	8	LEU
7	S	12	GLN
7	S	23	LYS
7	S	50	VAL
7	S	56	ASP
7	S	66	LEU
7	S	73	VAL
7	S	80	SER
7	S	168	THR
7	S	180	ASP
7	S	189	LEU
7	S	192	LEU
7	S	195	LEU
7	S	200	ASP
7	S	204	VAL
7	S	205	LEU
7	S	211	ASN
7	S	224	SER
7	S	226	SER
7	S	228	ILE
7	S	237	SER
7	S	253	LEU
7	S	256	LEU
7	S	270	MET
7	S	274	THR
7	S	278	THR
7	S	288	THR

Continued on next page...

Continued from previous page...

Mol	Chain	Res	Type
7	S	298	LEU
7	S	299	GLN
7	S	303	VAL
7	S	316	CYS
7	S	329	ASP
7	S	333	VAL
7	S	337	LEU
7	S	349	ILE
7	S	362	ARG
7	S	364	SER
7	S	367	LEU
7	S	369	SER
7	S	377	MET
7	S	378	MET
7	S	387	LEU
7	S	392	CYS
7	S	402	GLU
7	S	423	THR
7	S	424	SER
7	S	425	ARG
7	S	428	VAL
7	S	431	LEU
7	T	7	THR
7	T	8	LEU
7	T	12	GLN
7	T	23	LYS
7	T	50	VAL
7	T	56	ASP
7	T	66	LEU
7	T	73	VAL
7	T	80	SER
7	T	168	THR
7	T	180	ASP
7	T	189	LEU
7	T	192	LEU
7	T	195	LEU
7	T	200	ASP
7	T	204	VAL
7	T	205	LEU
7	T	211	ASN
7	T	224	SER
7	T	226	SER

Continued on next page...

Continued from previous page...

Mol	Chain	Res	Type
7	T	228	ILE
7	T	237	SER
7	T	253	LEU
7	T	256	LEU
7	T	270	MET
7	T	274	THR
7	T	278	THR
7	T	288	THR
7	T	298	LEU
7	T	299	GLN
7	T	303	VAL
7	T	316	CYS
7	T	329	ASP
7	T	333	VAL
7	T	337	LEU
7	T	349	ILE
7	T	362	ARG
7	T	364	SER
7	T	367	LEU
7	T	369	SER
7	T	377	MET
7	T	378	MET
7	T	387	LEU
7	T	392	CYS
7	T	402	GLU
7	T	423	THR
7	T	424	SER
7	T	425	ARG
7	T	428	VAL
7	T	431	LEU
7	U	7	THR
7	U	8	LEU
7	U	12	GLN
7	U	23	LYS
7	U	50	VAL
7	U	56	ASP
7	U	66	LEU
7	U	73	VAL
7	U	80	SER
7	U	168	THR
7	U	180	ASP
7	U	189	LEU

Continued on next page...

Continued from previous page...

Mol	Chain	Res	Type
7	U	192	LEU
7	U	195	LEU
7	U	200	ASP
7	U	204	VAL
7	U	205	LEU
7	U	211	ASN
7	U	224	SER
7	U	226	SER
7	U	228	ILE
7	U	237	SER
7	U	253	LEU
7	U	256	LEU
7	U	270	MET
7	U	274	THR
7	U	278	THR
7	U	288	THR
7	U	298	LEU
7	U	299	GLN
7	U	303	VAL
7	U	316	CYS
7	U	329	ASP
7	U	333	VAL
7	U	337	LEU
7	U	349	ILE
7	U	362	ARG
7	U	364	SER
7	U	367	LEU
7	U	369	SER
7	U	377	MET
7	U	378	MET
7	U	387	LEU
7	U	392	CYS
7	U	402	GLU
7	U	423	THR
7	U	424	SER
7	U	425	ARG
7	U	428	VAL
7	U	431	LEU
7	V	7	THR
7	V	8	LEU
7	V	12	GLN
7	V	23	LYS

Continued on next page...

Continued from previous page...

Mol	Chain	Res	Type
7	V	50	VAL
7	V	56	ASP
7	V	66	LEU
7	V	73	VAL
7	V	80	SER
7	V	168	THR
7	V	180	ASP
7	V	189	LEU
7	V	192	LEU
7	V	195	LEU
7	V	200	ASP
7	V	204	VAL
7	V	205	LEU
7	V	211	ASN
7	V	224	SER
7	V	226	SER
7	V	228	ILE
7	V	237	SER
7	V	253	LEU
7	V	256	LEU
7	V	270	MET
7	V	274	THR
7	V	278	THR
7	V	288	THR
7	V	298	LEU
7	V	299	GLN
7	V	303	VAL
7	V	316	CYS
7	V	329	ASP
7	V	333	VAL
7	V	337	LEU
7	V	349	ILE
7	V	362	ARG
7	V	364	SER
7	V	367	LEU
7	V	369	SER
7	V	377	MET
7	V	378	MET
7	V	387	LEU
7	V	392	CYS
7	V	402	GLU
7	V	423	THR

Continued on next page...

Continued from previous page...

Mol	Chain	Res	Type
7	V	424	SER
7	V	425	ARG
7	V	428	VAL
7	V	431	LEU
7	W	7	THR
7	W	8	LEU
7	W	12	GLN
7	W	23	LYS
7	W	50	VAL
7	W	56	ASP
7	W	66	LEU
7	W	73	VAL
7	W	80	SER
7	W	168	THR
7	W	180	ASP
7	W	189	LEU
7	W	192	LEU
7	W	195	LEU
7	W	200	ASP
7	W	204	VAL
7	W	205	LEU
7	W	211	ASN
7	W	224	SER
7	W	226	SER
7	W	228	ILE
7	W	237	SER
7	W	253	LEU
7	W	256	LEU
7	W	270	MET
7	W	274	THR
7	W	278	THR
7	W	288	THR
7	W	298	LEU
7	W	299	GLN
7	W	303	VAL
7	W	316	CYS
7	W	329	ASP
7	W	333	VAL
7	W	337	LEU
7	W	349	ILE
7	W	362	ARG
7	W	364	SER

Continued on next page...

Continued from previous page...

Mol	Chain	Res	Type
7	W	367	LEU
7	W	369	SER
7	W	377	MET
7	W	378	MET
7	W	387	LEU
7	W	392	CYS
7	W	402	GLU
7	W	423	THR
7	W	424	SER
7	W	425	ARG
7	W	428	VAL
7	W	431	LEU
7	X	7	THR
7	X	8	LEU
7	X	12	GLN
7	X	23	LYS
7	X	50	VAL
7	X	56	ASP
7	X	66	LEU
7	X	73	VAL
7	X	80	SER
7	X	168	THR
7	X	180	ASP
7	X	189	LEU
7	X	192	LEU
7	X	195	LEU
7	X	200	ASP
7	X	204	VAL
7	X	205	LEU
7	X	211	ASN
7	X	224	SER
7	X	226	SER
7	X	228	ILE
7	X	237	SER
7	X	253	LEU
7	X	256	LEU
7	X	270	MET
7	X	274	THR
7	X	278	THR
7	X	288	THR
7	X	298	LEU
7	X	299	GLN

Continued on next page...

Continued from previous page...

Mol	Chain	Res	Type
7	X	303	VAL
7	X	316	CYS
7	X	329	ASP
7	X	333	VAL
7	X	337	LEU
7	X	349	ILE
7	X	362	ARG
7	X	364	SER
7	X	367	LEU
7	X	369	SER
7	X	377	MET
7	X	378	MET
7	X	387	LEU
7	X	392	CYS
7	X	402	GLU
7	X	423	THR
7	X	424	SER
7	X	425	ARG
7	X	428	VAL
7	X	431	LEU
7	Y	7	THR
7	Y	8	LEU
7	Y	12	GLN
7	Y	23	LYS
7	Y	50	VAL
7	Y	56	ASP
7	Y	66	LEU
7	Y	73	VAL
7	Y	80	SER
7	Y	168	THR
7	Y	180	ASP
7	Y	189	LEU
7	Y	192	LEU
7	Y	195	LEU
7	Y	200	ASP
7	Y	204	VAL
7	Y	205	LEU
7	Y	211	ASN
7	Y	224	SER
7	Y	226	SER
7	Y	228	ILE
7	Y	237	SER

Continued on next page...

Continued from previous page...

Mol	Chain	Res	Type
7	Y	253	LEU
7	Y	256	LEU
7	Y	270	MET
7	Y	274	THR
7	Y	278	THR
7	Y	288	THR
7	Y	298	LEU
7	Y	299	GLN
7	Y	303	VAL
7	Y	316	CYS
7	Y	329	ASP
7	Y	333	VAL
7	Y	337	LEU
7	Y	349	ILE
7	Y	362	ARG
7	Y	364	SER
7	Y	367	LEU
7	Y	369	SER
7	Y	377	MET
7	Y	378	MET
7	Y	387	LEU
7	Y	392	CYS
7	Y	402	GLU
7	Y	423	THR
7	Y	424	SER
7	Y	425	ARG
7	Y	428	VAL
7	Y	431	LEU
7	Z	7	THR
7	Z	8	LEU
7	Z	12	GLN
7	Z	23	LYS
7	Z	50	VAL
7	Z	56	ASP
7	Z	66	LEU
7	Z	73	VAL
7	Z	80	SER
7	Z	168	THR
7	Z	180	ASP
7	Z	189	LEU
7	Z	192	LEU
7	Z	195	LEU

Continued on next page...

Continued from previous page...

Mol	Chain	Res	Type
7	Z	200	ASP
7	Z	204	VAL
7	Z	205	LEU
7	Z	211	ASN
7	Z	224	SER
7	Z	226	SER
7	Z	228	ILE
7	Z	237	SER
7	Z	253	LEU
7	Z	256	LEU
7	Z	270	MET
7	Z	274	THR
7	Z	278	THR
7	Z	288	THR
7	Z	298	LEU
7	Z	299	GLN
7	Z	303	VAL
7	Z	316	CYS
7	Z	329	ASP
7	Z	333	VAL
7	Z	337	LEU
7	Z	349	ILE
7	Z	362	ARG
7	Z	364	SER
7	Z	367	LEU
7	Z	369	SER
7	Z	377	MET
7	Z	378	MET
7	Z	387	LEU
7	Z	392	CYS
7	Z	402	GLU
7	Z	423	THR
7	Z	424	SER
7	Z	425	ARG
7	Z	428	VAL
7	Z	431	LEU

Sometimes sidechains can be flipped to improve hydrogen bonding and reduce clashes. All (142) such sidechains are listed below:

Mol	Chain	Res	Type
1	l	15	GLN
2	j	31	GLN

Continued on next page...

Continued from previous page...

Mol	Chain	Res	Type
2	j	65	GLN
3	m	56	ASN
4	E	261	HIS
4	E	309	GLN
4	E	316	GLN
4	E	684	GLN
4	E	718	ASN
4	E	760	ASN
4	E	767	GLN
2	F	416	GLN
2	F	609	ASN
2	F	687	ASN
2	F	703	GLN
2	F	742	GLN
2	F	746	HIS
2	F	786	GLN
2	F	830	ASN
4	G	165	GLN
4	G	169	ASN
4	G	309	GLN
4	G	314	HIS
4	G	329	GLN
4	G	360	HIS
4	G	412	HIS
4	G	436	GLN
4	G	444	GLN
4	G	487	GLN
4	G	512	HIS
4	G	565	ASN
4	G	639	GLN
4	G	650	HIS
4	G	684	GLN
4	G	688	ASN
4	G	718	ASN
2	H	269	ASN
2	H	273	ASN
2	H	330	GLN
2	H	401	HIS
2	H	491	ASN
2	H	702	HIS
2	H	717	GLN
2	H	719	GLN

Continued on next page...

Continued from previous page...

Mol	Chain	Res	Type
5	I	35	HIS
5	I	82	HIS
5	I	123	ASN
5	I	317	GLN
5	I	499	GLN
5	I	581	HIS
5	I	611	GLN
5	I	622	GLN
1	J	222	HIS
1	J	694	HIS
1	J	892	HIS
1	J	895	ASN
5	K	61	GLN
5	K	69	GLN
5	K	102	GLN
5	K	415	HIS
5	K	476	ASN
6	L	343	GLN
6	L	412	HIS
6	L	571	HIS
6	L	1657	GLN
6	L	1767	GLN
6	L	1805	ASN
3	b	56	ASN
2	a	31	GLN
2	a	84	GLN
7	S	24	GLN
7	S	29	HIS
7	S	54	GLN
7	S	59	HIS
7	S	187	ASN
7	S	197	GLN
7	S	198	ASN
7	S	338	GLN
7	S	347	ASN
7	T	24	GLN
7	T	29	HIS
7	T	54	GLN
7	T	59	HIS
7	T	187	ASN
7	T	197	GLN
7	T	198	ASN

Continued on next page...

Continued from previous page...

Mol	Chain	Res	Type
7	T	338	GLN
7	T	347	ASN
7	U	24	GLN
7	U	29	HIS
7	U	54	GLN
7	U	59	HIS
7	U	187	ASN
7	U	197	GLN
7	U	198	ASN
7	U	338	GLN
7	U	347	ASN
7	V	24	GLN
7	V	29	HIS
7	V	54	GLN
7	V	59	HIS
7	V	187	ASN
7	V	197	GLN
7	V	198	ASN
7	V	338	GLN
7	V	347	ASN
7	W	24	GLN
7	W	29	HIS
7	W	54	GLN
7	W	59	HIS
7	W	187	ASN
7	W	197	GLN
7	W	198	ASN
7	W	338	GLN
7	W	347	ASN
7	X	24	GLN
7	X	29	HIS
7	X	54	GLN
7	X	59	HIS
7	X	187	ASN
7	X	197	GLN
7	X	198	ASN
7	X	338	GLN
7	X	347	ASN
7	Y	24	GLN
7	Y	29	HIS
7	Y	54	GLN
7	Y	59	HIS

Continued on next page...

Continued from previous page...

Mol	Chain	Res	Type
7	Y	187	ASN
7	Y	197	GLN
7	Y	198	ASN
7	Y	338	GLN
7	Y	347	ASN
7	Z	24	GLN
7	Z	29	HIS
7	Z	54	GLN
7	Z	59	HIS
7	Z	187	ASN
7	Z	197	GLN
7	Z	198	ASN
7	Z	338	GLN
7	Z	347	ASN

5.3.3 RNA [i](#)

There are no RNA molecules in this entry.

5.4 Non-standard residues in protein, DNA, RNA chains [i](#)

There are no non-standard protein/DNA/RNA residues in this entry.

5.5 Carbohydrates [i](#)

There are no monosaccharides in this entry.

5.6 Ligand geometry [i](#)

There are no ligands in this entry.

5.7 Other polymers [i](#)

There are no such residues in this entry.

5.8 Polymer linkage issues [i](#)

There are no chain breaks in this entry.

6 Map visualisation [i](#)

This section contains visualisations of the EMDB entry EMD-14007. These allow visual inspection of the internal detail of the map and identification of artifacts.

No raw map or half-maps were deposited for this entry and therefore no images, graphs, etc. pertaining to the raw map can be shown.

6.1 Orthogonal projections [i](#)

6.1.1 Primary map

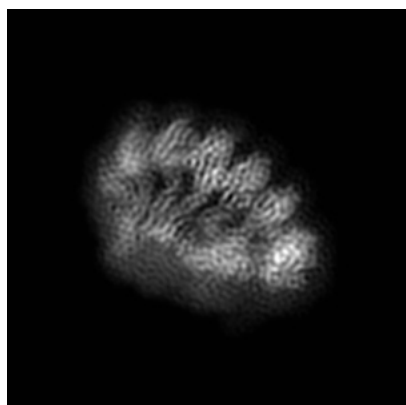

X

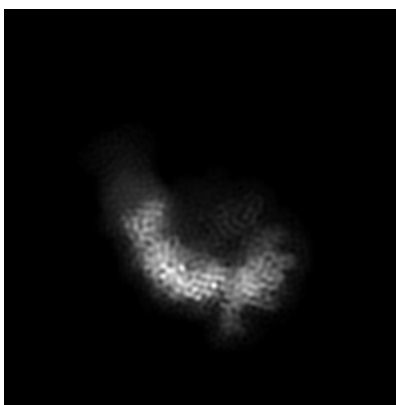

Y

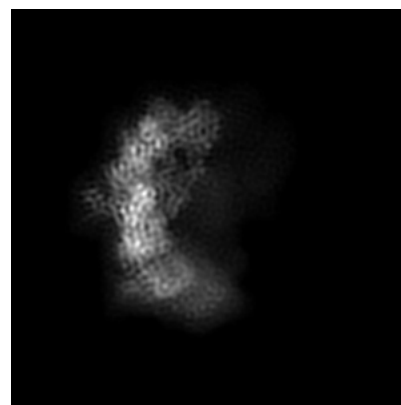

Z

The images above show the map projected in three orthogonal directions.

6.2 Central slices [i](#)

6.2.1 Primary map

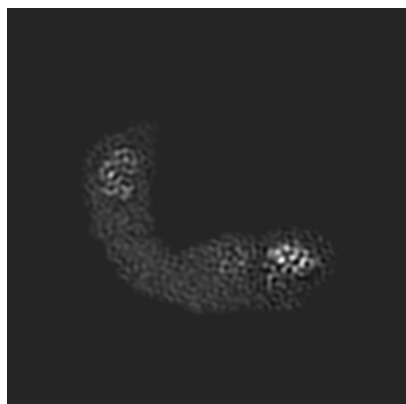

X Index: 100

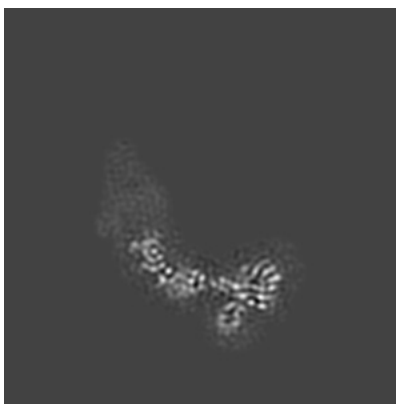

Y Index: 100

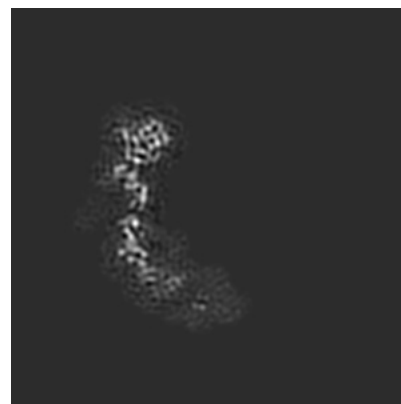

Z Index: 100

The images above show central slices of the map in three orthogonal directions.

6.3 Largest variance slices [i](#)

6.3.1 Primary map



X Index: 62

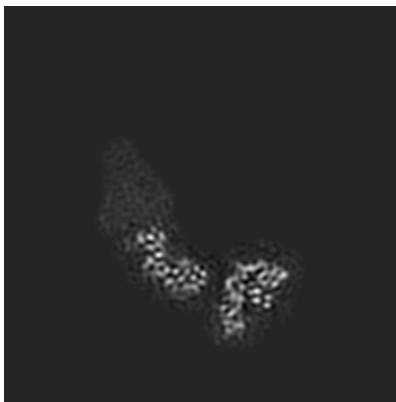

Y Index: 103



Z Index: 81

The images above show the largest variance slices of the map in three orthogonal directions.

6.4 Orthogonal standard-deviation projections (False-color) [i](#)

6.4.1 Primary map

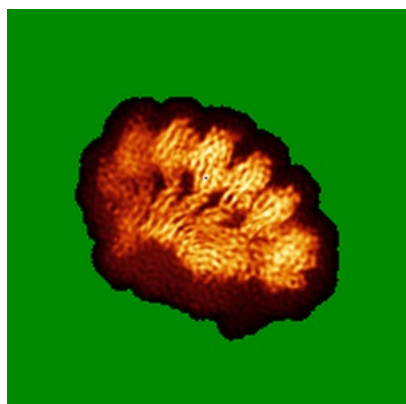

X

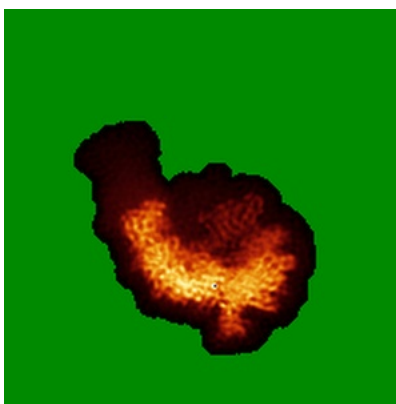

Y

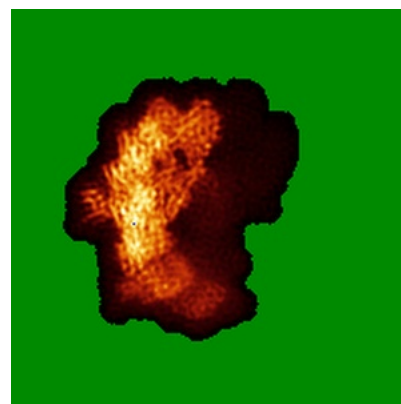

Z

The images above show the map standard deviation projections with false color in three orthogonal directions. Minimum values are shown in green, max in blue, and dark to light orange shades represent small to large values respectively.

6.5 Orthogonal surface views [i](#)

6.5.1 Primary map

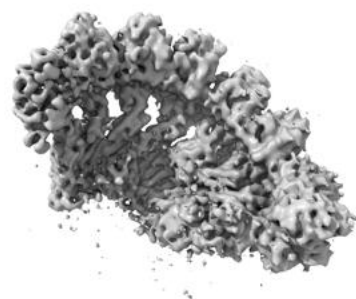

X



Y

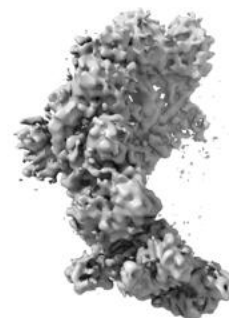

Z

The images above show the 3D surface view of the map at the recommended contour level 0.0287. These images, in conjunction with the slice images, may facilitate assessment of whether an appropriate contour level has been provided.

6.6 Mask visualisation [i](#)

This section was not generated. No masks/segmentation were deposited.

7 Map analysis [i](#)

This section contains the results of statistical analysis of the map.

7.1 Map-value distribution [i](#)

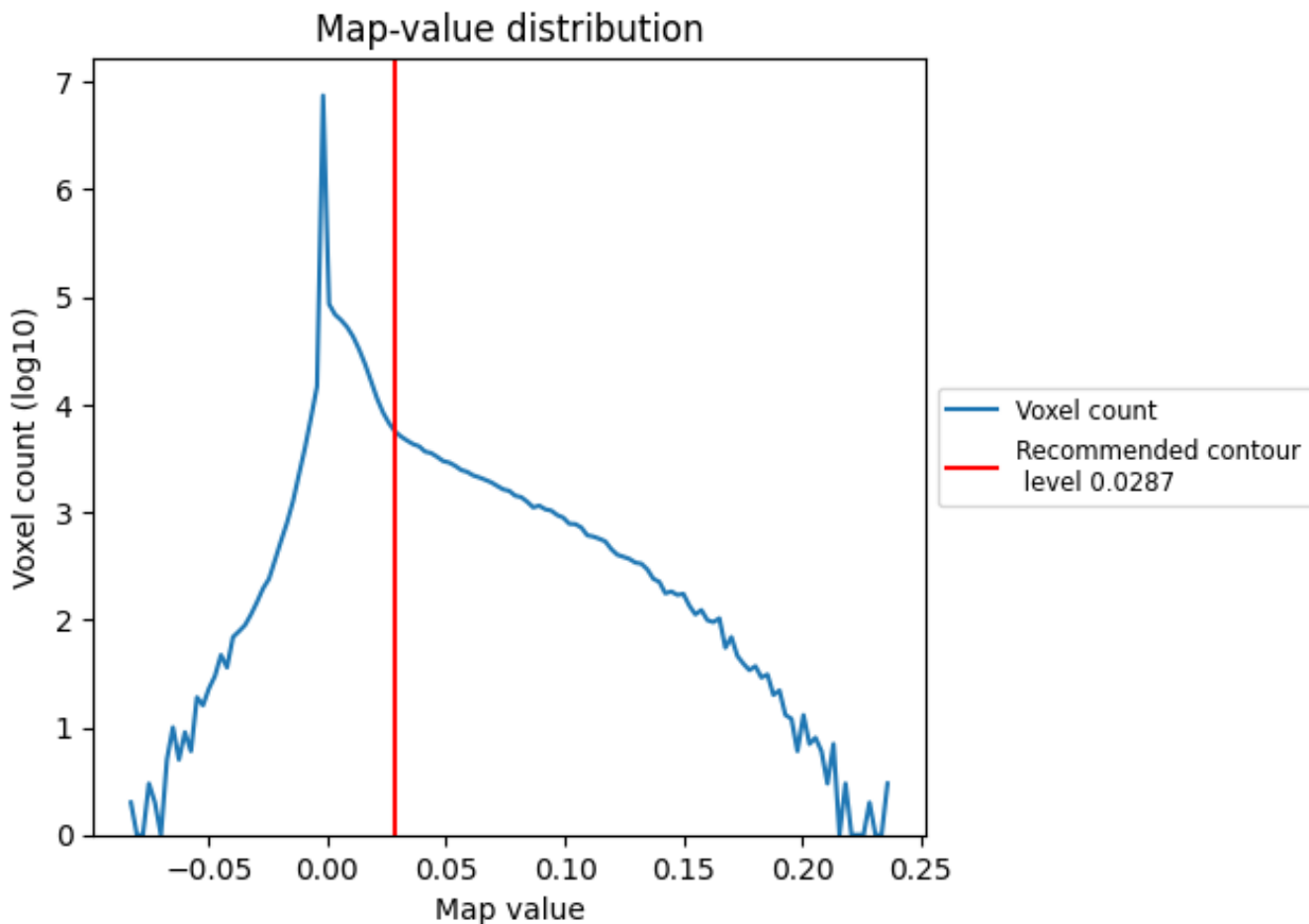

The map-value distribution is plotted in 128 intervals along the x-axis. The y-axis is logarithmic. A spike in this graph at zero usually indicates that the volume has been masked.

7.2 Volume estimate [i](#)

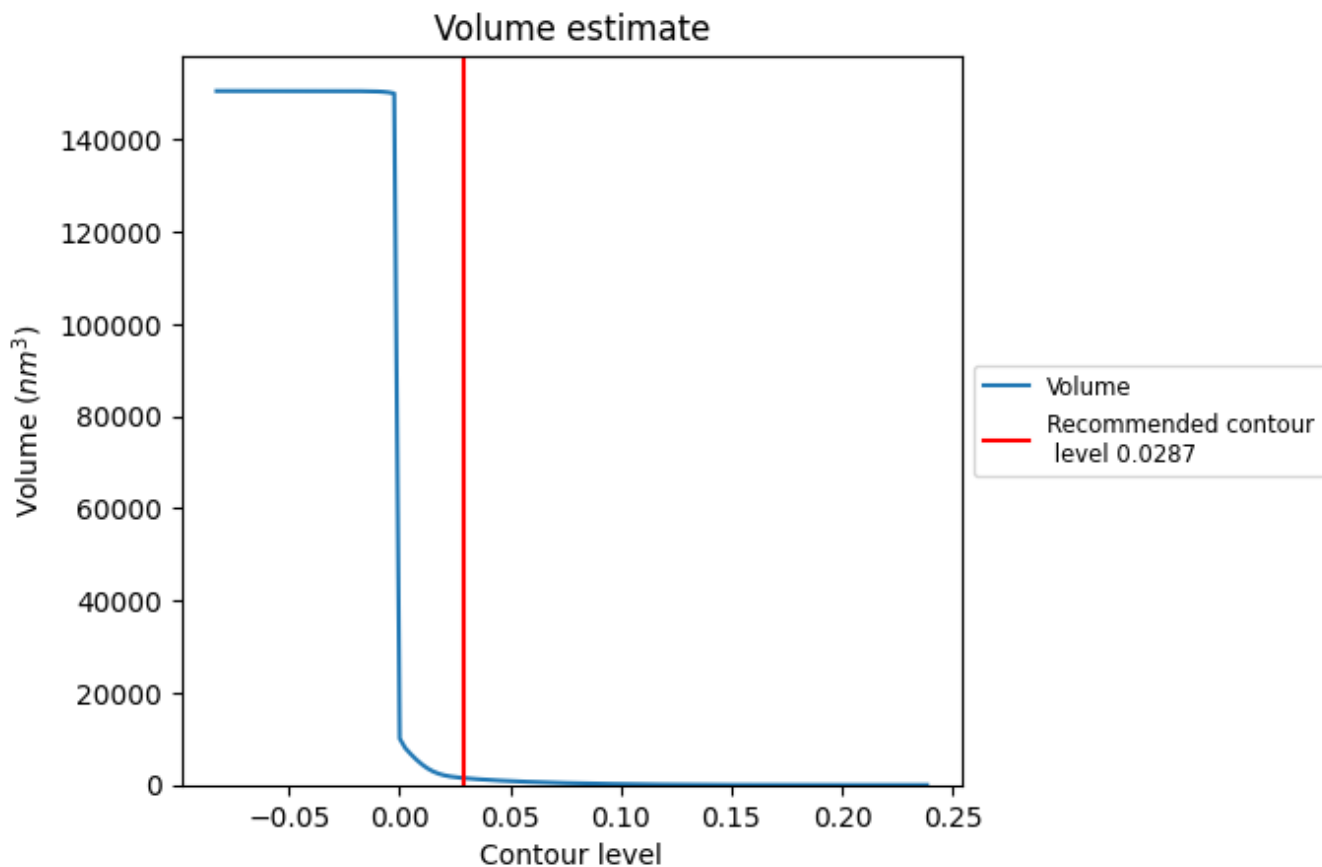

The volume at the recommended contour level is 1509 nm^3 ; this corresponds to an approximate mass of 1363 kDa.

The volume estimate graph shows how the enclosed volume varies with the contour level. The recommended contour level is shown as a vertical line and the intersection between the line and the curve gives the volume of the enclosed surface at the given level.

7.3 Rotationally averaged power spectrum [i](#)

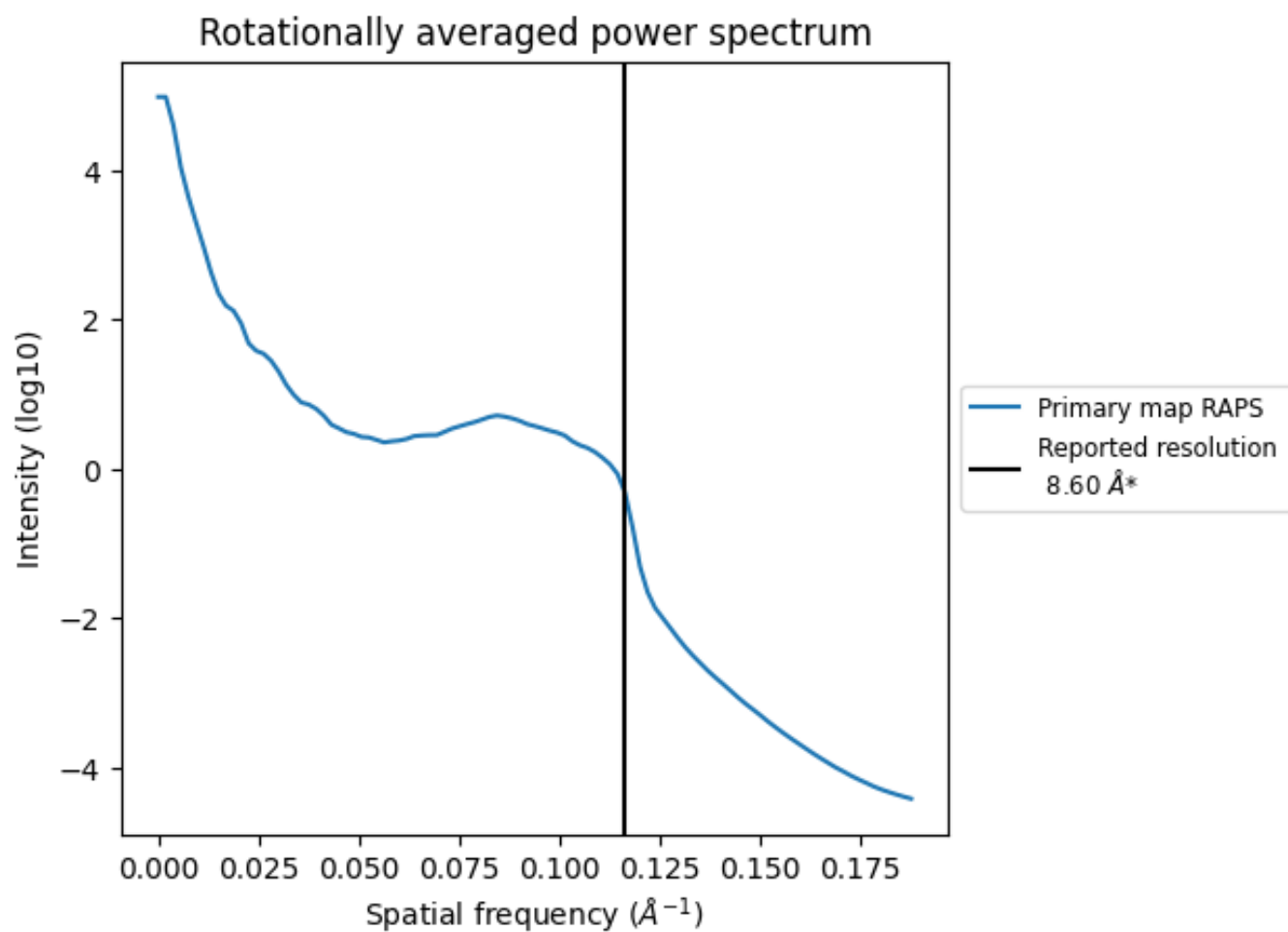

*Reported resolution corresponds to spatial frequency of 0.116 Å⁻¹

8 Fourier-Shell correlation

This section was not generated. No FSC curve or half-maps provided.

9 Map-model fit [i](#)

This section contains information regarding the fit between EMDB map EMD-14007 and PDB model 7QJ2. Per-residue inclusion information can be found in section 3 on page 6.

9.1 Map-model overlay [i](#)

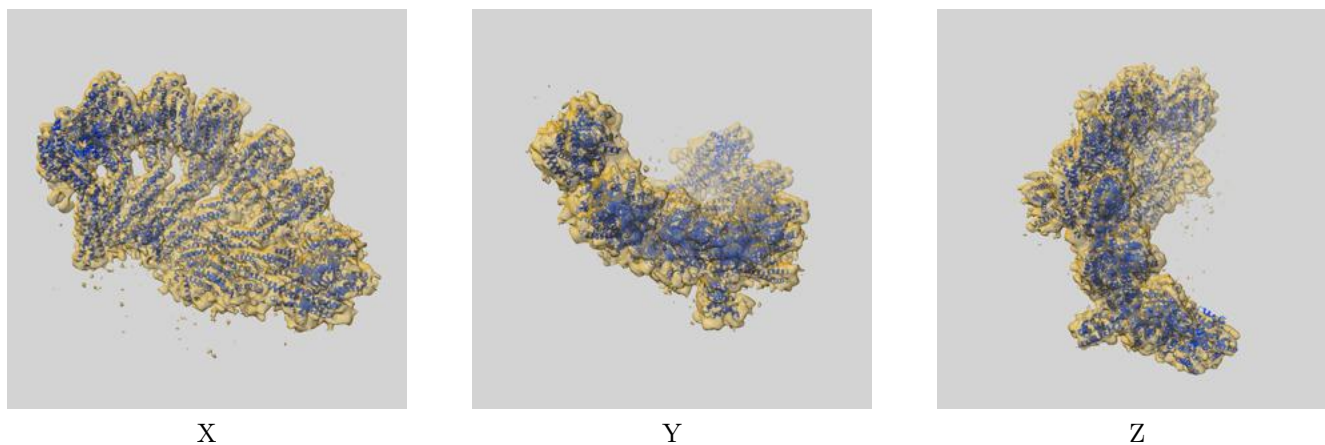

The images above show the 3D surface view of the map at the recommended contour level 0.0287 at 50% transparency in yellow overlaid with a ribbon representation of the model coloured in blue. These images allow for the visual assessment of the quality of fit between the atomic model and the map.

9.2 Q-score mapped to coordinate model [i](#)

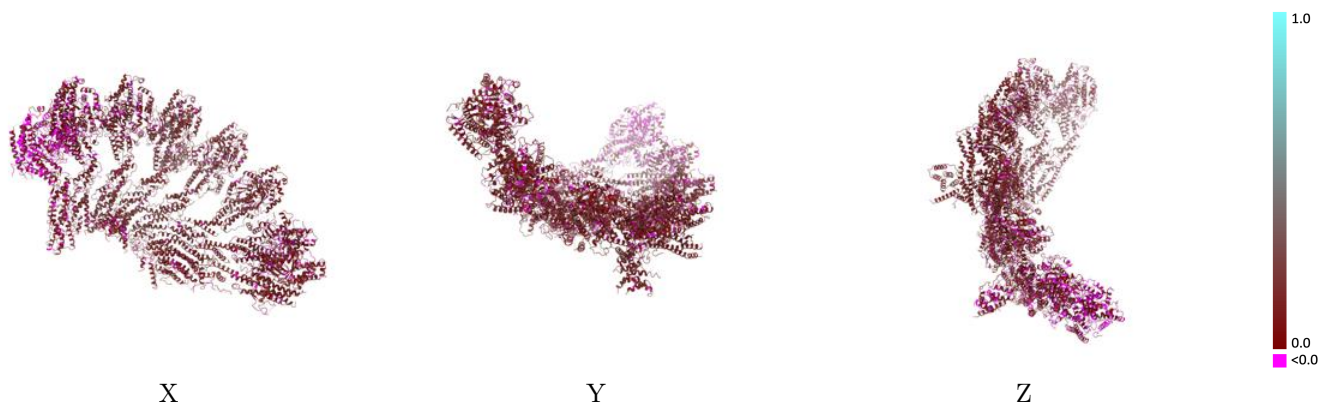

The images above show the model with each residue coloured according to its Q-score. This shows their resolvability in the map with higher Q-score values reflecting better resolvability. Please note: Q-score is calculating the resolvability of atoms, and thus high values are only expected at resolutions at which atoms can be resolved. Low Q-score values may therefore be expected for many entries.

9.3 Atom inclusion mapped to coordinate model [i](#)

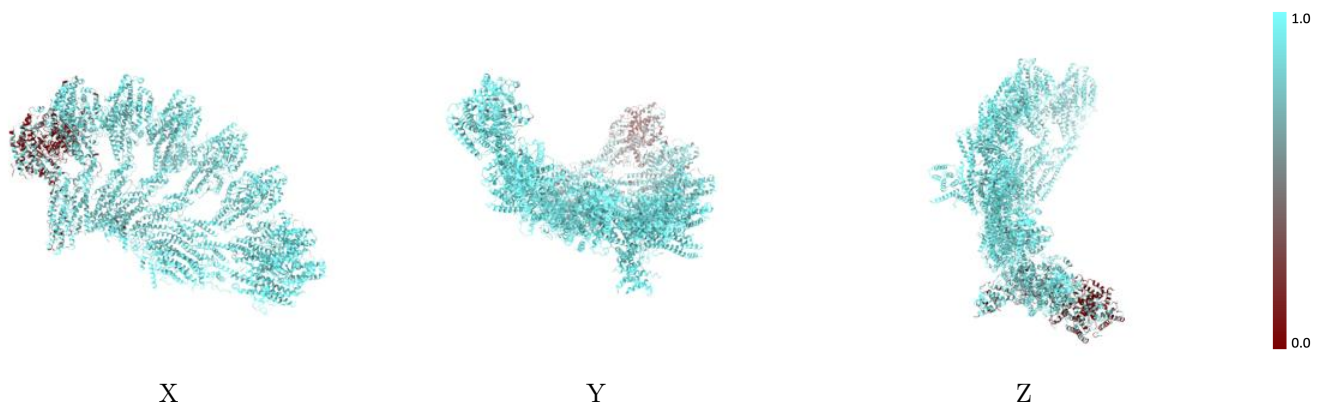

The images above show the model with each residue coloured according to its atom inclusion. This shows to what extent they are inside the map at the recommended contour level (0.0287).



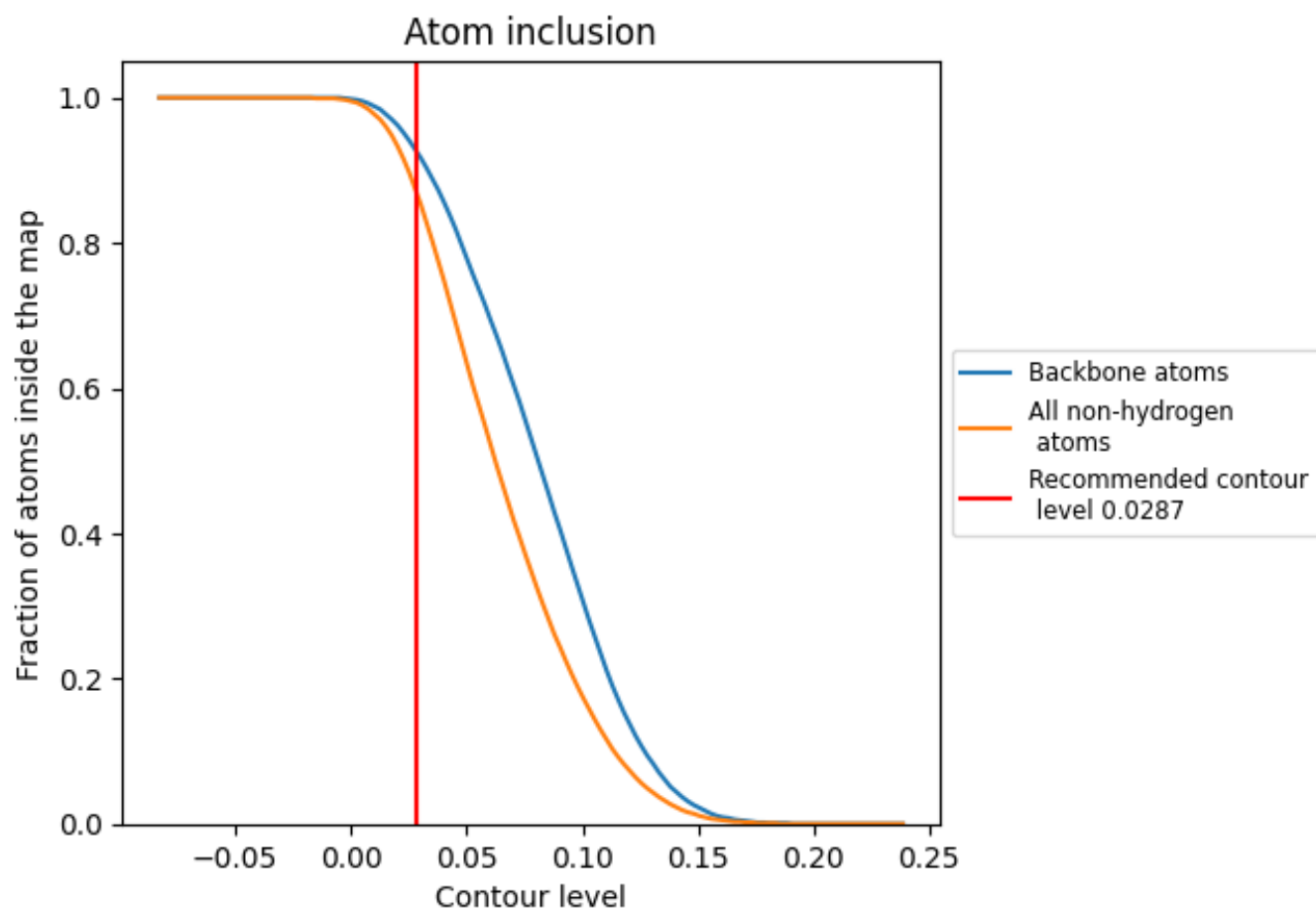











































9.4 Atom inclusion [i](#)



At the recommended contour level, 92% of all backbone atoms, 87% of all non-hydrogen atoms, are inside the map.

9.5 Map-model fit summary

The table lists the average atom inclusion at the recommended contour level (0.0287) and Q-score for the entire model and for each chain.

Chain	Atom inclusion	Q-score
All	 0.8660	 0.1300
E	 0.6140	 0.0890
F	 0.8370	 0.1210
G	 0.9270	 0.1450
H	 0.9320	 0.1530
I	 0.9340	 0.1610
J	 0.9510	 0.1610
K	 0.9520	 0.1500
L	 0.9450	 0.1520
S	 0.3440	 0.0050
T	 0.8210	 0.0870
U	 0.9240	 0.1350
V	 0.9490	 0.1520
W	 0.9500	 0.1410
X	 0.9490	 0.1410
Y	 0.9520	 0.1250
Z	 0.9180	 0.1290
a	 0.7920	 0.1130
b	 0.8000	 0.1340
j	 0.7650	 0.1090
k	 0.6910	 0.1050
l	 0.9460	 0.1660
m	 0.9350	 0.1730

