



## Full wwPDB EM Validation Report ⓘ

Dec 12, 2022 – 07:27 am GMT

PDB ID : 6YBA  
EMDB ID : EMD-10768  
Title : HAdV-F41 Capsid  
Authors : Perez Illana, M.; Martinez, M.; Mangroo, C.; Brown, M.; Marabini, R.; San Martin, C.  
Deposited on : 2020-03-16  
Resolution : 4.00 Å(reported)

This is a Full wwPDB EM Validation Report for a publicly released PDB entry.

We welcome your comments at [validation@mail.wwpdb.org](mailto:validation@mail.wwpdb.org)

A user guide is available at

<https://www.wwpdb.org/validation/2017/EMValidationReportHelp>

with specific help available everywhere you see the ⓘ symbol.

The types of validation reports are described at

<http://www.wwpdb.org/validation/2017/FAQs#types>.

---

The following versions of software and data (see [references ⓘ](#)) were used in the production of this report:

EMDB validation analysis : 0.0.1.dev43  
MolProbity : 4.02b-467  
Percentile statistics : 20191225.v01 (using entries in the PDB archive December 25th 2019)  
MapQ : 1.9.9  
Ideal geometry (proteins) : Engh & Huber (2001)  
Ideal geometry (DNA, RNA) : Parkinson et al. (1996)  
Validation Pipeline (wwPDB-VP) : 2.31.3

# 1 Overall quality at a glance i

The following experimental techniques were used to determine the structure:  
*ELECTRON MICROSCOPY*

The reported resolution of this entry is 4.00 Å.

Percentile scores (ranging between 0-100) for global validation metrics of the entry are shown in the following graphic. The table shows the number of entries on which the scores are based.

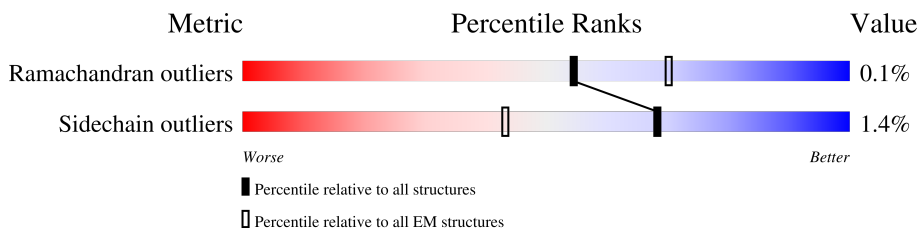

Metric	Whole archive (#Entries)	EM structures (#Entries)
Ramachandran outliers	154571	4023
Sidechain outliers	154315	3826

The table below summarises the geometric issues observed across the polymeric chains and their fit to the map. The red, orange, yellow and green segments of the bar indicate the fraction of residues that contain outliers for  $\geq 3$ , 2, 1 and 0 types of geometric quality criteria respectively. A grey segment represents the fraction of residues that are not modelled. The numeric value for each fraction is indicated below the corresponding segment, with a dot representing fractions  $\leq 5\%$ . The upper red bar (where present) indicates the fraction of residues that have poor fit to the EM map (all-atom inclusion  $< 40\%$ ). The numeric value is given above the bar.

Mol	Chain	Length	Quality of chain
1	A	925	<div style="display: flex; align-items: center;"> <div style="width: 24%; height: 10px; background-color: red; margin-right: 5px;"></div> <div style="width: 76%; height: 10px; background-color: green; margin-right: 5px;"></div> <div style="width: 2%; height: 10px; background-color: yellow; margin-right: 5px;"></div> <div style="width: 2%; height: 10px; background-color: grey;"></div> </div> <p style="text-align: center;">24% <span style="float: right;">96%</span></p>
1	B	925	<div style="display: flex; align-items: center;"> <div style="width: 25%; height: 10px; background-color: red; margin-right: 5px;"></div> <div style="width: 75%; height: 10px; background-color: green; margin-right: 5px;"></div> <div style="width: 2%; height: 10px; background-color: yellow; margin-right: 5px;"></div> <div style="width: 2%; height: 10px; background-color: grey;"></div> </div> <p style="text-align: center;">25% <span style="float: right;">97%</span></p>
1	C	925	<div style="display: flex; align-items: center;"> <div style="width: 23%; height: 10px; background-color: red; margin-right: 5px;"></div> <div style="width: 77%; height: 10px; background-color: green; margin-right: 5px;"></div> <div style="width: 2%; height: 10px; background-color: yellow; margin-right: 5px;"></div> <div style="width: 2%; height: 10px; background-color: grey;"></div> </div> <p style="text-align: center;">23% <span style="float: right;">96%</span></p>
1	D	925	<div style="display: flex; align-items: center;"> <div style="width: 18%; height: 10px; background-color: red; margin-right: 5px;"></div> <div style="width: 82%; height: 10px; background-color: green; margin-right: 5px;"></div> <div style="width: 2%; height: 10px; background-color: yellow; margin-right: 5px;"></div> <div style="width: 2%; height: 10px; background-color: grey;"></div> </div> <p style="text-align: center;">18% <span style="float: right;">96%</span></p>
1	E	925	<div style="display: flex; align-items: center;"> <div style="width: 20%; height: 10px; background-color: red; margin-right: 5px;"></div> <div style="width: 80%; height: 10px; background-color: green; margin-right: 5px;"></div> <div style="width: 2%; height: 10px; background-color: yellow; margin-right: 5px;"></div> <div style="width: 2%; height: 10px; background-color: grey;"></div> </div> <p style="text-align: center;">20% <span style="float: right;">96%</span></p>
1	F	925	<div style="display: flex; align-items: center;"> <div style="width: 20%; height: 10px; background-color: red; margin-right: 5px;"></div> <div style="width: 75%; height: 10px; background-color: green; margin-right: 5px;"></div> <div style="width: 2%; height: 10px; background-color: yellow; margin-right: 5px;"></div> <div style="width: 2%; height: 10px; background-color: grey;"></div> </div> <p style="text-align: center;">20% <span style="float: right;">95%</span></p>
1	G	925	<div style="display: flex; align-items: center;"> <div style="width: 18%; height: 10px; background-color: red; margin-right: 5px;"></div> <div style="width: 82%; height: 10px; background-color: green; margin-right: 5px;"></div> <div style="width: 2%; height: 10px; background-color: yellow; margin-right: 5px;"></div> <div style="width: 2%; height: 10px; background-color: grey;"></div> </div> <p style="text-align: center;">18% <span style="float: right;">95%</span></p>
1	H	925	<div style="display: flex; align-items: center;"> <div style="width: 17%; height: 10px; background-color: red; margin-right: 5px;"></div> <div style="width: 83%; height: 10px; background-color: green; margin-right: 5px;"></div> <div style="width: 2%; height: 10px; background-color: yellow; margin-right: 5px;"></div> <div style="width: 2%; height: 10px; background-color: grey;"></div> </div> <p style="text-align: center;">17% <span style="float: right;">96%</span></p>
1	I	925	<div style="display: flex; align-items: center;"> <div style="width: 18%; height: 10px; background-color: red; margin-right: 5px;"></div> <div style="width: 82%; height: 10px; background-color: green; margin-right: 5px;"></div> <div style="width: 2%; height: 10px; background-color: yellow; margin-right: 5px;"></div> <div style="width: 2%; height: 10px; background-color: grey;"></div> </div> <p style="text-align: center;">18% <span style="float: right;">97%</span></p>

*Continued on next page...*

Continued from previous page...

Mol	Chain	Length	Quality of chain
1	J	925	21% 96%
1	K	925	20% 95%
1	L	925	20% 96%
2	M	508	33% 87% 11%
3	N	579	21% 51% 49%
4	O	233	13% 76% 23%
4	P	233	11% 76% 23%
5	Q	133	13% 36% 62%
5	R	133	14% 36% 62%
5	S	133	12% 36% 62%
5	T	133	8% 36% 62%
6	U	266	9% 11% 89%
6	V	266	5% 11% 89%
6	Y	266	11% 89%
6	u	266	9% 11% 89%
7	W	183	97%
7	w	183	5% 7% 93%

## 2 Entry composition [i](#)

There are 7 unique types of molecules in this entry. The entry contains 98037 atoms, of which 0 are hydrogens and 0 are deuteriums.

In the tables below, the AltConf column contains the number of residues with at least one atom in alternate conformation and the Trace column contains the number of residues modelled with at most 2 atoms.

- Molecule 1 is a protein called Hexon protein.

Mol	Chain	Residues	Atoms					AltConf	Trace
			Total	C	N	O	S		
1	A	912	Total 7244	C 4603	N 1226	O 1379	S 36	0	0
1	B	913	Total 7250	C 4607	N 1227	O 1380	S 36	0	0
1	C	914	Total 7254	C 4610	N 1227	O 1381	S 36	0	0
1	D	908	Total 7214	C 4585	N 1221	O 1372	S 36	0	0
1	E	917	Total 7273	C 4620	N 1231	O 1386	S 36	0	0
1	F	910	Total 7229	C 4595	N 1223	O 1375	S 36	0	0
1	G	910	Total 7229	C 4595	N 1223	O 1375	S 36	0	0
1	H	915	Total 7262	C 4615	N 1228	O 1382	S 37	0	0
1	I	908	Total 7214	C 4585	N 1221	O 1372	S 36	0	0
1	J	914	Total 7254	C 4610	N 1227	O 1381	S 36	0	0
1	K	912	Total 7242	C 4603	N 1225	O 1378	S 36	0	0
1	L	911	Total 7238	C 4601	N 1224	O 1377	S 36	0	0

- Molecule 2 is a protein called Penton protein.

Mol	Chain	Residues	Atoms					AltConf	Trace
			Total	C	N	O	S		
2	M	452	Total 3609	C 2288	N 621	O 688	S 12	0	0

- Molecule 3 is a protein called Pre-hexon-linking protein IIIa.

Mol	Chain	Residues	Atoms					AltConf	Trace
3	N	298	Total	C	N	O	S	0	0
			2315	1447	413	451	4		

- Molecule 4 is a protein called Pre-hexon-linking protein VIII.

Mol	Chain	Residues	Atoms					AltConf	Trace
4	O	180	Total	C	N	O	S	0	0
			1379	865	236	273	5		
4	P	180	Total	C	N	O	S	0	0
			1379	865	236	273	5		

- Molecule 5 is a protein called Hexon-interlacing protein.

Mol	Chain	Residues	Atoms					AltConf	Trace
5	Q	50	Total	C	N	O	S	0	0
			365	232	65	67	1		
5	R	50	Total	C	N	O	S	0	0
			365	232	65	67	1		
5	S	50	Total	C	N	O	S	0	0
			365	232	65	67	1		
5	T	50	Total	C	N	O	S	0	0
			365	232	65	67	1		

- Molecule 6 is a protein called Pre-protein VI.

Mol	Chain	Residues	Atoms					AltConf	Trace
6	U	29	Total	C	N	O	S	0	0
			218	135	42	40	1		
6	V	29	Total	C	N	O	S	0	0
			218	135	42	40	1		
6	Y	29	Total	C	N	O	S	0	0
			218	135	42	40	1		
6	u	29	Total	C	N	O	S	0	0
			218	135	42	40	1		

- Molecule 7 is a protein called Pre-histone-like nucleoprotein.

Mol	Chain	Residues	Atoms					AltConf	Trace
7	W	6	Total	C	N	O	S	0	0
			37	23	6	7	1		
7	w	12	Total	C	N	O	S	0	0
			83	53	15	14	1		

### 3 Residue-property plots [i](#)

These plots are drawn for all protein, RNA, DNA and oligosaccharide chains in the entry. The first graphic for a chain summarises the proportions of the various outlier classes displayed in the second graphic. The second graphic shows the sequence view annotated by issues in geometry and atom inclusion in map density. Residues are color-coded according to the number of geometric quality criteria for which they contain at least one outlier: green = 0, yellow = 1, orange = 2 and red = 3 or more. A red diamond above a residue indicates a poor fit to the EM map for this residue (all-atom inclusion < 40%). Stretches of 2 or more consecutive residues without any outlier are shown as a green connector. Residues present in the sample, but not in the model, are shown in grey.

- Molecule 1: Hexon protein



- Molecule 1: Hexon protein

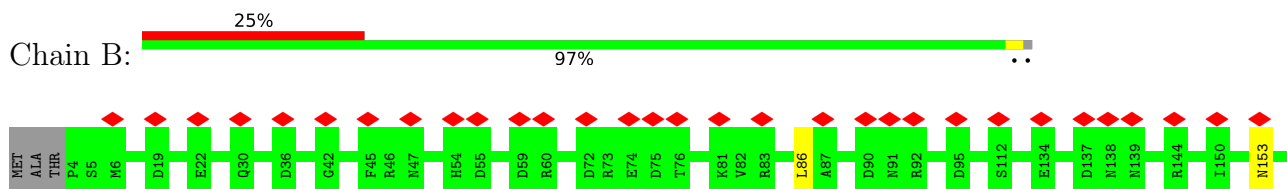



• Molecule 1: Hexon protein



• Molecule 1: Hexon protein

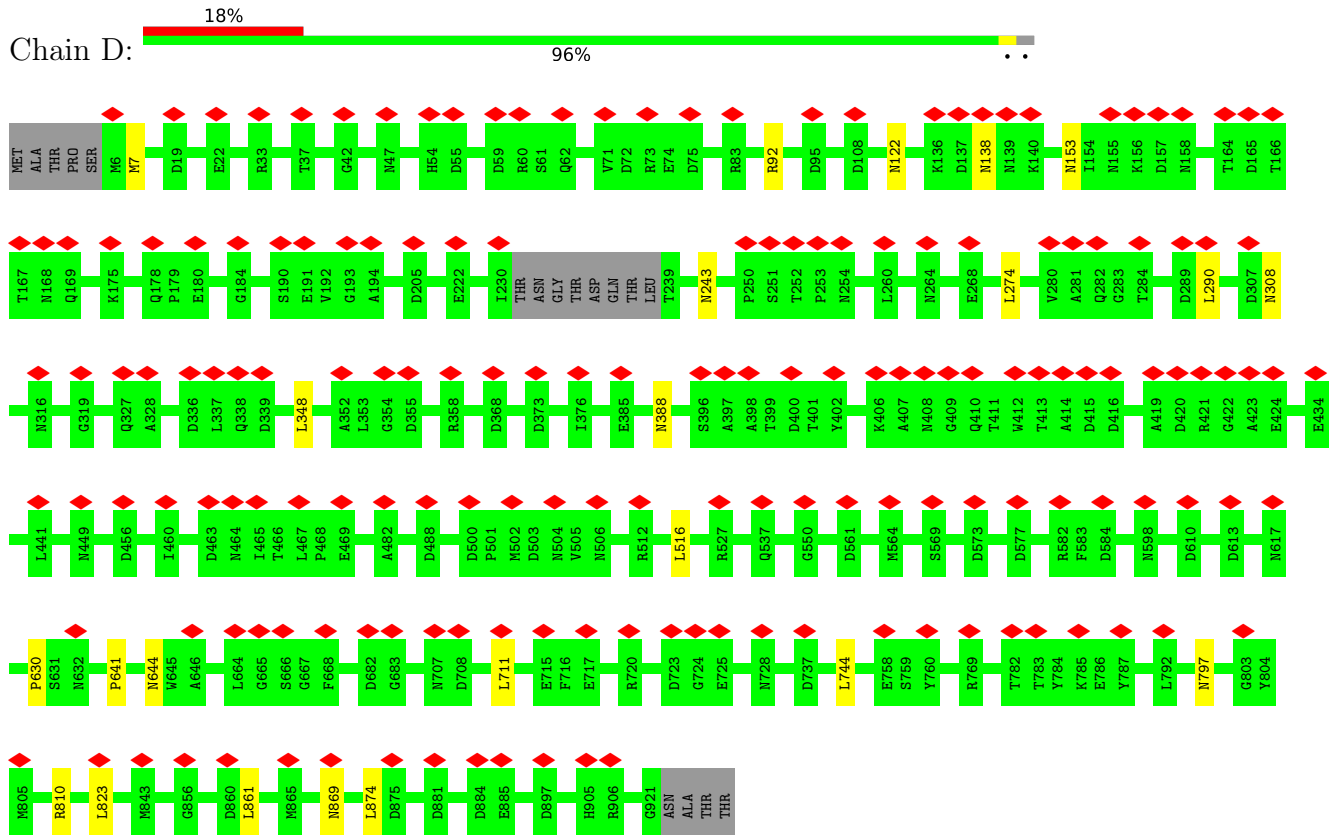

• Molecule 1: Hexon protein

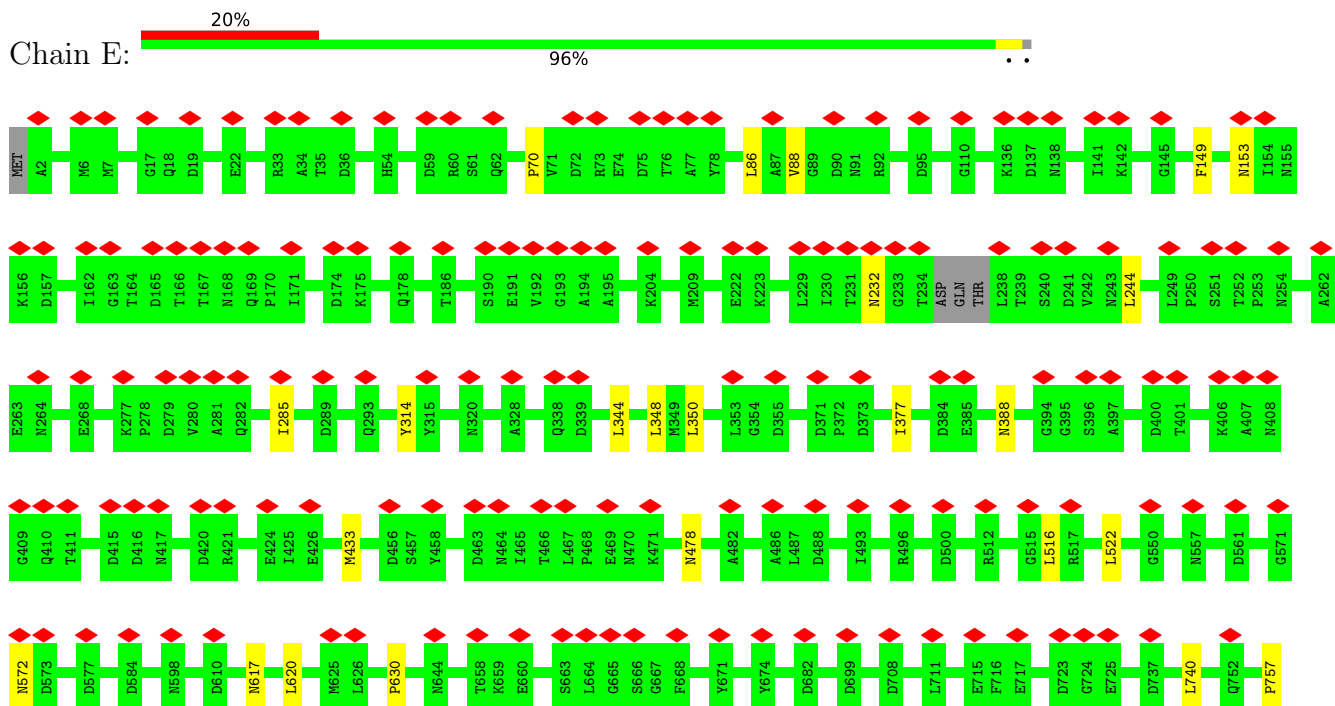



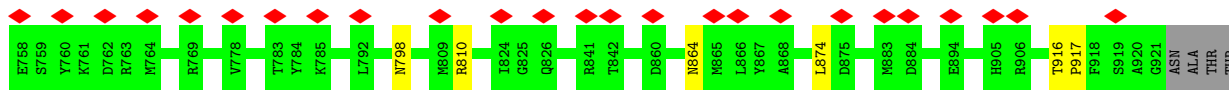

• Molecule 1: Hexon protein

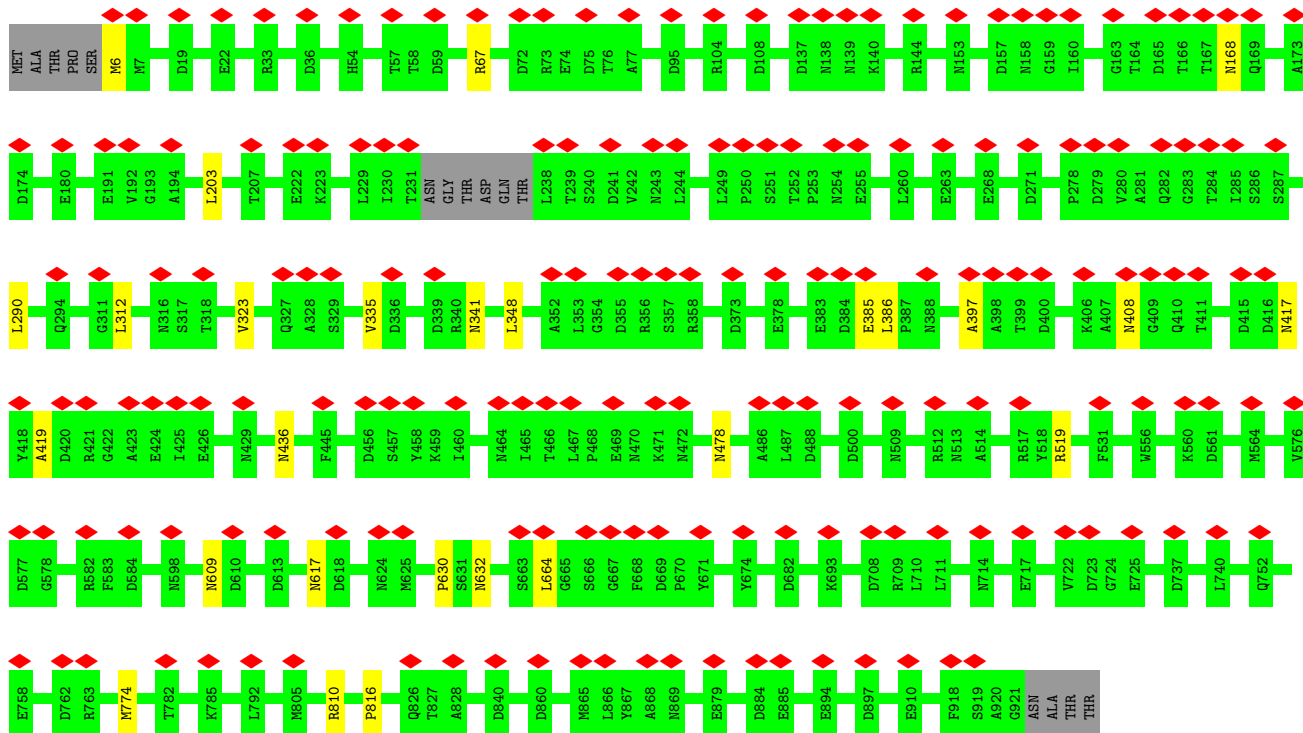
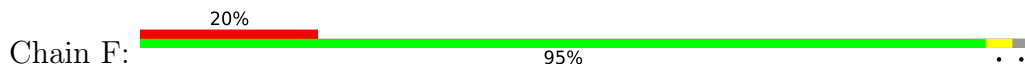

• Molecule 1: Hexon protein

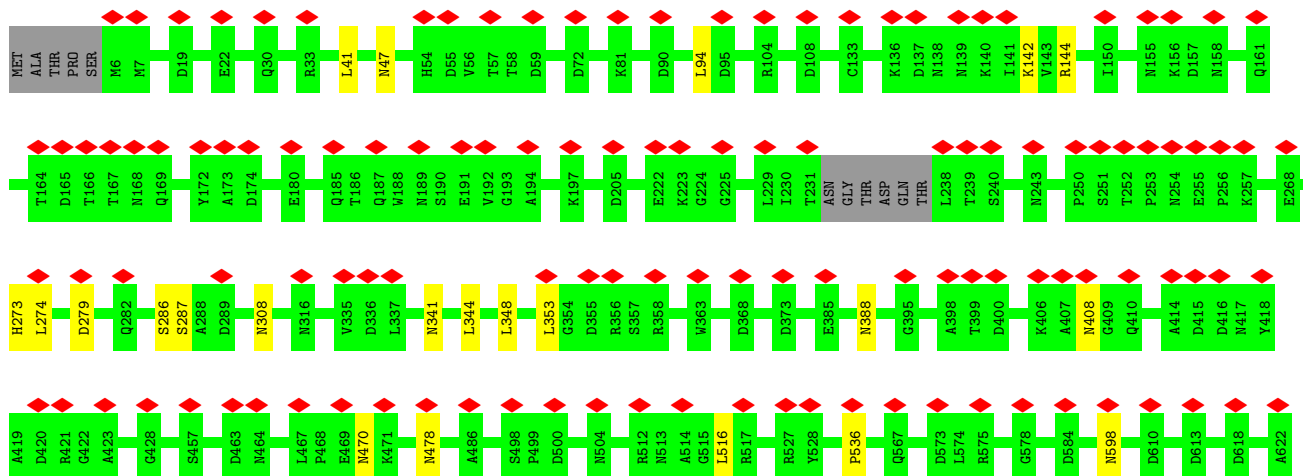

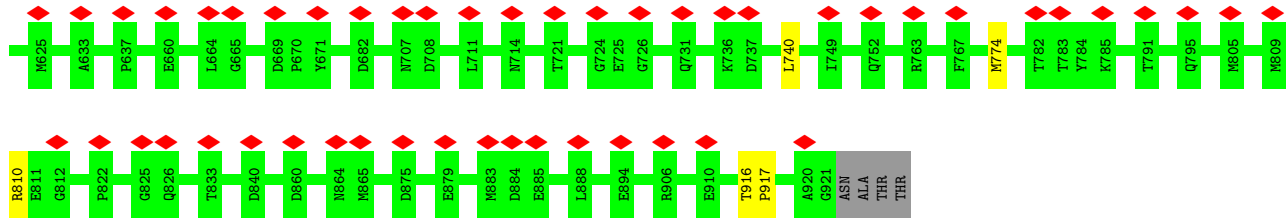

• Molecule 1: Hexon protein



• Molecule 1: Hexon protein

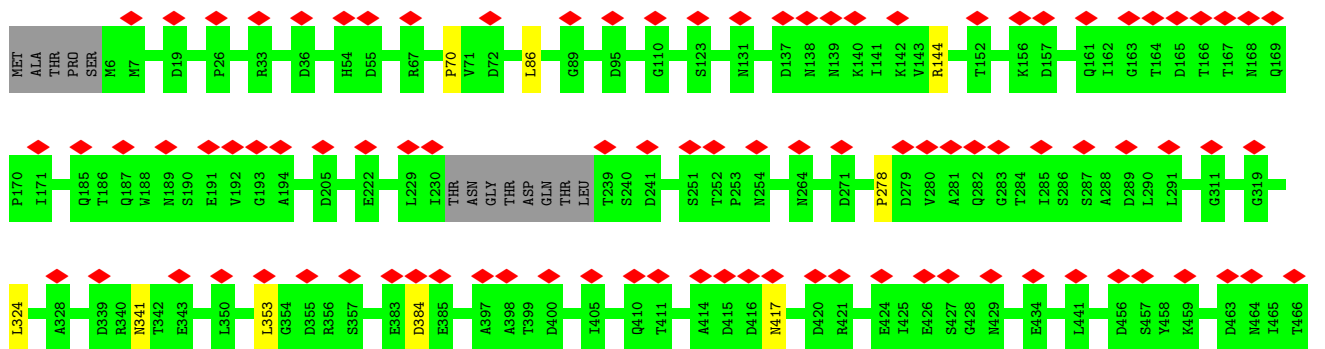

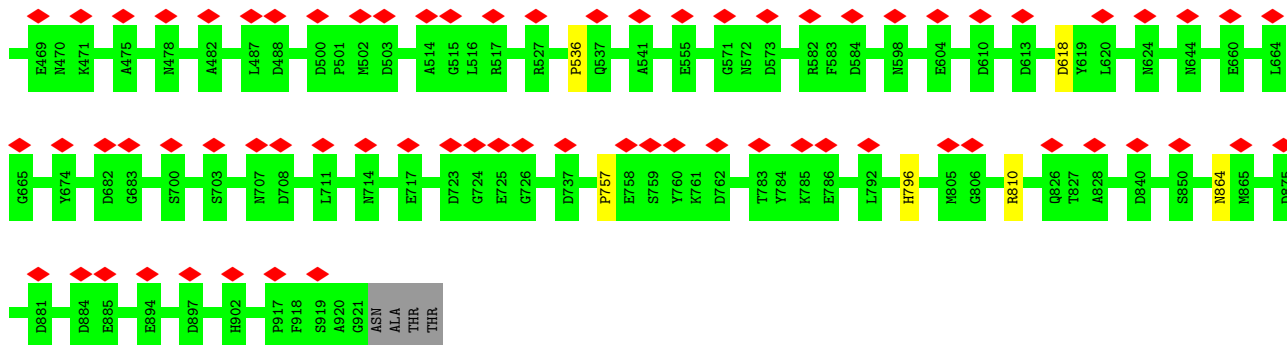

• Molecule 1: Hexon protein

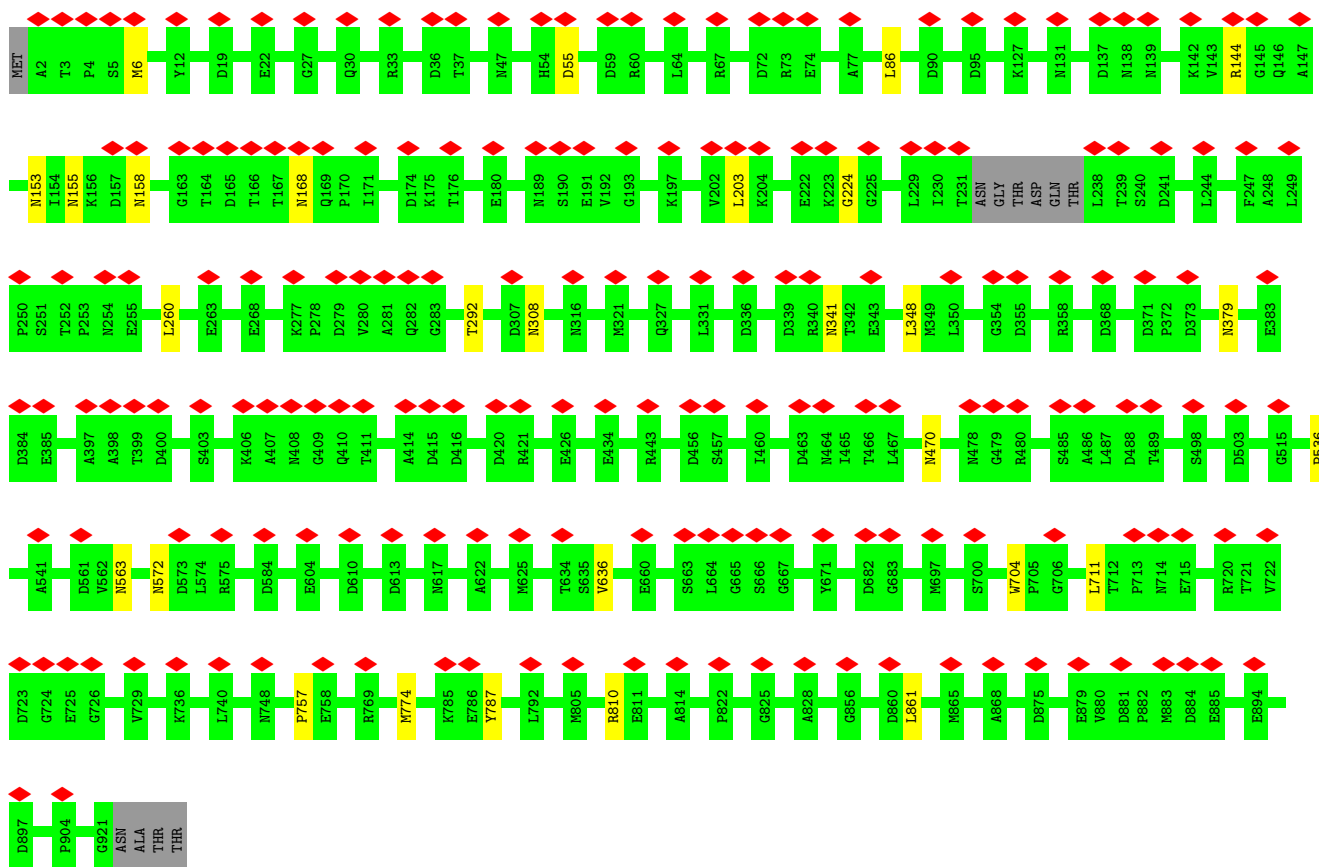

• Molecule 1: Hexon protein

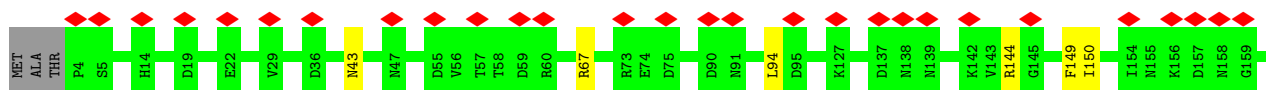

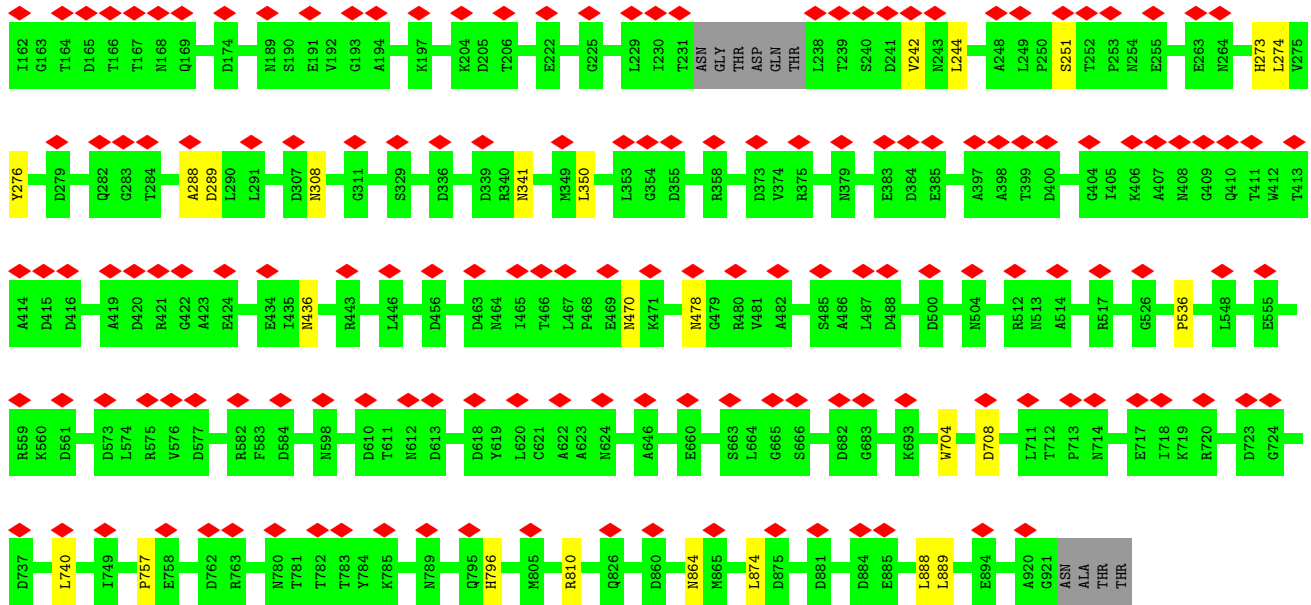

• Molecule 1: Hexon protein

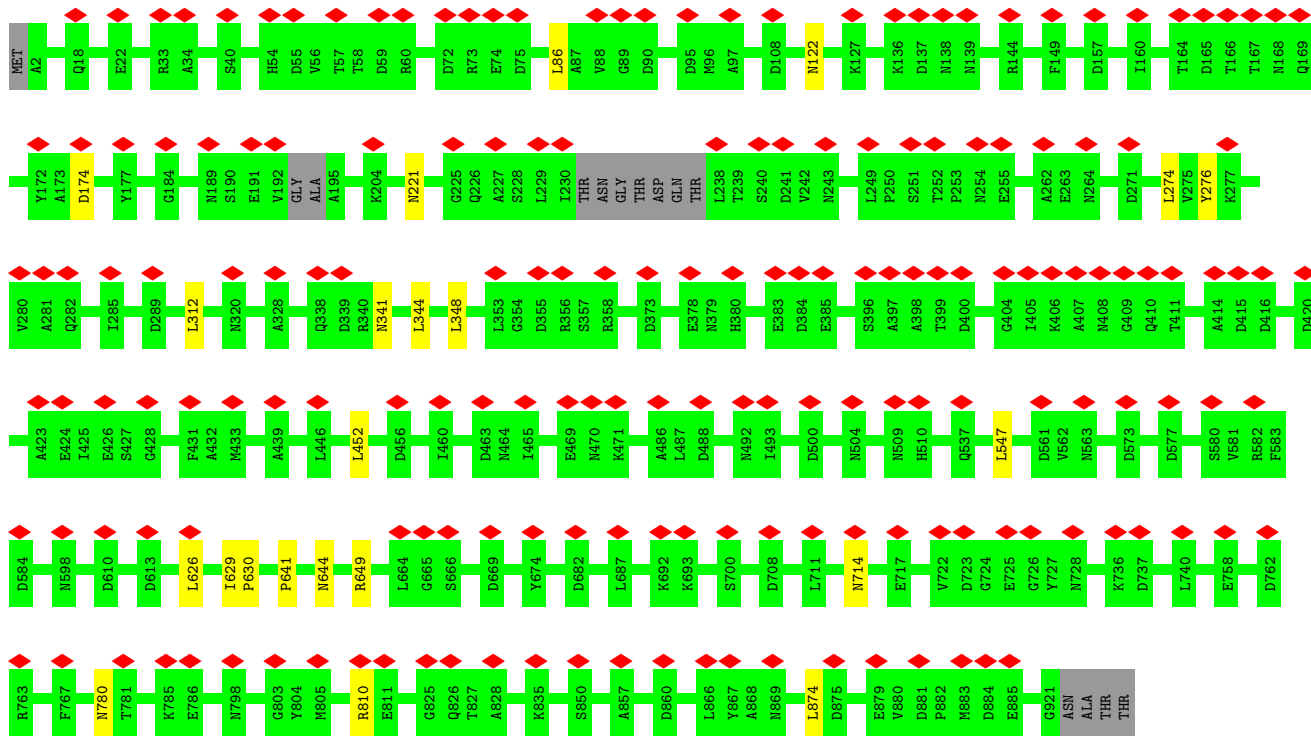

• Molecule 2: Penton protein

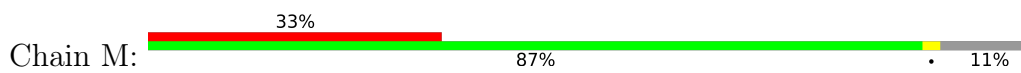













## 4 Experimental information

Property	Value	Source
EM reconstruction method	SINGLE PARTICLE	Depositor
Imposed symmetry	POINT, I	Depositor
Number of particles used	9926	Depositor
Resolution determination method	FSC 0.143 CUT-OFF	Depositor
CTF correction method	PHASE FLIPPING AND AMPLITUDE CORRECTION	Depositor
Microscope	FEI TITAN KRIOS	Depositor
Voltage (kV)	300	Depositor
Electron dose ( $e^-/\text{\AA}^2$ )	42	Depositor
Minimum defocus (nm)	Not provided	
Maximum defocus (nm)	Not provided	
Magnification	Not provided	
Image detector	FEI FALCON III (4k x 4k)	Depositor
Maximum map value	0.364	Depositor
Minimum map value	-0.253	Depositor
Average map value	0.001	Depositor
Map value standard deviation	0.027	Depositor
Recommended contour level	0.07	Depositor
Map size (Å)	1060.8, 1060.8, 1060.8	wwPDB
Map dimensions	780, 780, 780	wwPDB
Map angles (°)	90.0, 90.0, 90.0	wwPDB
Pixel spacing (Å)	1.36, 1.36, 1.36	Depositor

## 5 Model quality i

### 5.1 Standard geometry i

The Z score for a bond length (or angle) is the number of standard deviations the observed value is removed from the expected value. A bond length (or angle) with  $|Z| > 5$  is considered an outlier worth inspection. RMSZ is the root-mean-square of all Z scores of the bond lengths (or angles).

Mol	Chain	Bond lengths		Bond angles	
		RMSZ	# Z  >5	RMSZ	# Z  >5
1	A	0.39	0/7444	0.68	5/10145 (0.0%)
1	B	0.39	0/7451	0.70	4/10154 (0.0%)
1	C	0.38	0/7455	0.70	8/10161 (0.1%)
1	D	0.40	0/7414	0.71	9/10103 (0.1%)
1	E	0.40	0/7474	0.69	11/10187 (0.1%)
1	F	0.40	0/7429	0.69	7/10124 (0.1%)
1	G	0.42	0/7429	0.71	9/10124 (0.1%)
1	H	0.42	0/7463	0.72	7/10171 (0.1%)
1	I	0.42	0/7414	0.70	2/10103 (0.0%)
1	J	0.40	0/7455	0.71	5/10161 (0.0%)
1	K	0.39	0/7443	0.70	10/10143 (0.1%)
1	L	0.42	1/7438 (0.0%)	0.70	10/10136 (0.1%)
2	M	0.35	0/3695	0.58	0/5035
3	N	0.32	0/2353	0.59	2/3206 (0.1%)
4	O	0.38	0/1417	0.54	0/1935
4	P	0.38	0/1417	0.54	0/1935
5	Q	0.39	0/374	0.66	0/512
5	R	0.39	0/374	0.66	0/512
5	S	0.39	0/374	0.66	0/512
5	T	0.39	0/374	0.66	0/512
6	U	0.31	0/224	0.54	0/302
6	V	0.31	0/224	0.54	0/302
6	Y	0.31	0/224	0.54	0/302
6	u	0.31	0/224	0.54	0/302
7	W	0.30	0/37	0.53	0/47
7	w	0.33	0/86	0.55	0/114
All	All	0.40	1/100706 (0.0%)	0.69	89/137240 (0.1%)

Chiral center outliers are detected by calculating the chiral volume of a chiral center and verifying if the center is modelled as a planar moiety or with the opposite hand. A planarity outlier is detected by checking planarity of atoms in a peptide group, atoms in a mainchain group or atoms of a sidechain that are expected to be planar.

Mol	Chain	#Chirality outliers	#Planarity outliers
1	A	0	4
1	B	0	6
1	C	0	8
1	D	0	2
1	E	0	7
1	F	0	3
1	G	0	4
1	H	0	4
1	I	0	5
1	J	0	6
1	K	0	8
1	L	0	3
2	M	0	3
All	All	0	63

All (1) bond length outliers are listed below:

Mol	Chain	Res	Type	Atoms	Z	Observed(Å)	Ideal(Å)
1	L	547	LEU	C-N	-5.50	1.21	1.34

All (89) bond angle outliers are listed below:

Mol	Chain	Res	Type	Atoms	Z	Observed(°)	Ideal(°)
1	G	274	LEU	CA-CB-CG	7.96	133.61	115.30
1	J	348	LEU	CA-CB-CG	7.79	133.21	115.30
1	L	274	LEU	CA-CB-CG	7.74	133.11	115.30
1	C	744	LEU	CA-CB-CG	7.71	133.04	115.30
1	D	274	LEU	CA-CB-CG	7.50	132.54	115.30
1	C	260	LEU	CA-CB-CG	7.44	132.41	115.30
1	J	260	LEU	CA-CB-CG	7.29	132.06	115.30
1	C	86	LEU	CA-CB-CG	7.06	131.54	115.30
1	B	86	LEU	CA-CB-CG	7.03	131.47	115.30
1	A	892	LEU	CA-CB-CG	6.74	130.80	115.30
1	K	276	TYR	C-N-CA	-6.71	104.94	121.70
1	G	348	LEU	CA-CB-CG	6.56	130.39	115.30
1	B	744	LEU	CA-CB-CG	6.56	130.39	115.30
1	F	203	LEU	CA-CB-CG	6.55	130.35	115.30
1	G	353	LEU	CA-CB-CG	6.44	130.11	115.30
1	I	353	LEU	CA-CB-CG	6.37	129.94	115.30
1	D	823	LEU	CA-CB-CG	6.30	129.80	115.30
1	D	348	LEU	CA-CB-CG	6.28	129.74	115.30
1	D	516	LEU	CA-CB-CG	6.27	129.73	115.30
1	F	664	LEU	CA-CB-CG	6.18	129.52	115.30

*Continued on next page...*

*Continued from previous page...*

Mol	Chain	Res	Type	Atoms	Z	Observed(°)	Ideal(°)
1	K	350	LEU	CA-CB-CG	6.15	129.45	115.30
1	A	348	LEU	CA-CB-CG	6.15	129.44	115.30
1	J	86	LEU	CA-CB-CG	6.13	129.41	115.30
1	F	312	LEU	CA-CB-CG	6.11	129.36	115.30
1	H	452	LEU	CA-CB-CG	6.11	129.35	115.30
1	H	86	LEU	CA-CB-CG	6.02	129.14	115.30
1	E	433	MET	CB-CG-SD	6.01	130.44	112.40
1	F	348	LEU	CA-CB-CG	6.01	129.11	115.30
1	D	874	LEU	CA-CB-CG	5.97	129.02	115.30
1	C	203	LEU	CA-CB-CG	5.96	129.00	115.30
1	H	626	LEU	CA-CB-CG	5.93	128.94	115.30
1	K	888	LEU	CA-CB-CG	5.92	128.92	115.30
1	I	86	LEU	CA-CB-CG	5.84	128.73	115.30
1	C	290	LEU	CA-CB-CG	5.79	128.62	115.30
3	N	145	LEU	CA-CB-CG	5.78	128.60	115.30
1	K	708	ASP	CB-CG-OD1	5.78	123.50	118.30
1	J	203	LEU	CA-CB-CG	5.75	128.53	115.30
1	H	309	PHE	CB-CG-CD1	5.67	124.77	120.80
1	H	181	PRO	C-N-CA	5.66	135.86	121.70
1	B	655	ARG	NE-CZ-NH2	-5.63	117.48	120.30
1	L	344	LEU	CA-CB-CG	5.62	128.23	115.30
1	D	744	LEU	CA-CB-CG	5.62	128.22	115.30
1	G	344	LEU	CA-CB-CG	5.62	128.22	115.30
1	C	710	LEU	CA-CB-CG	5.59	128.16	115.30
1	E	350	LEU	CA-CB-CG	5.58	128.13	115.30
1	D	290	LEU	CA-CB-CG	5.52	127.99	115.30
1	F	519	ARG	NE-CZ-NH2	-5.49	117.56	120.30
1	G	41	LEU	CA-CB-CG	5.46	127.85	115.30
1	K	740	LEU	CA-CB-CG	5.45	127.84	115.30
1	A	708	ASP	CB-CG-OD1	5.44	123.20	118.30
1	E	348	LEU	CA-CB-CG	5.39	127.70	115.30
1	E	522	LEU	CA-CB-CG	5.39	127.69	115.30
3	N	45	LEU	CA-CB-CG	5.37	127.66	115.30
1	F	290	LEU	CA-CB-CG	5.37	127.66	115.30
1	K	244	LEU	CA-CB-CG	5.37	127.65	115.30
1	K	889	LEU	CA-CB-CG	5.36	127.64	115.30
1	E	244	LEU	CA-CB-CG	5.36	127.62	115.30
1	E	874	LEU	CA-CB-CG	5.34	127.59	115.30
1	G	740	LEU	CA-CB-CG	5.33	127.56	115.30
1	H	892	LEU	CA-CB-CG	5.30	127.50	115.30
1	K	94	LEU	CA-CB-CG	5.29	127.48	115.30
1	L	452	LEU	CA-CB-CG	5.27	127.42	115.30

*Continued on next page...*

*Continued from previous page...*

Mol	Chain	Res	Type	Atoms	Z	Observed(°)	Ideal(°)
1	A	744	LEU	CA-CB-CG	5.26	127.39	115.30
1	L	312	LEU	CA-CB-CG	5.24	127.36	115.30
1	G	94	LEU	CA-CB-CG	5.22	127.32	115.30
1	K	274	LEU	CA-CB-CG	5.22	127.31	115.30
1	E	344	LEU	CA-CB-CG	5.21	127.28	115.30
1	L	629	ILE	CG1-CB-CG2	-5.21	99.94	111.40
1	L	626	LEU	CA-CB-CG	5.19	127.23	115.30
1	L	348	LEU	CA-CB-CG	5.17	127.18	115.30
1	E	740	LEU	CA-CB-CG	5.16	127.17	115.30
1	L	86	LEU	CA-CB-CG	5.16	127.17	115.30
1	A	545	LEU	CA-CB-CG	5.15	127.15	115.30
1	D	711	LEU	CA-CB-CG	5.15	127.14	115.30
1	K	874	LEU	CA-CB-CG	5.15	127.14	115.30
1	E	516	LEU	CA-CB-CG	5.13	127.09	115.30
1	G	516	LEU	CA-CB-CG	5.13	127.09	115.30
1	D	861	LEU	CA-CB-CG	5.10	127.03	115.30
1	L	874	LEU	CA-CB-CG	5.10	127.02	115.30
1	E	86	LEU	CA-CB-CG	5.08	126.97	115.30
1	G	279	ASP	CB-CG-OD1	5.07	122.87	118.30
1	F	386	LEU	CA-CB-CG	5.07	126.96	115.30
1	E	620	LEU	CA-CB-CG	5.06	126.94	115.30
1	C	620	LEU	CA-CB-CG	5.05	126.92	115.30
1	J	711	LEU	CA-CB-CG	5.04	126.90	115.30
1	H	344	LEU	CA-CB-CG	5.04	126.89	115.30
1	C	253	PRO	C-N-CA	5.04	134.29	121.70
1	L	276	TYR	C-N-CA	-5.04	109.11	121.70
1	B	892	LEU	CA-CB-CG	5.03	126.88	115.30

There are no chirality outliers.

All (63) planarity outliers are listed below:

Mol	Chain	Res	Type	Group
1	A	312	LEU	Peptide
1	A	612	ASN	Peptide
1	A	704	TRP	Peptide
1	A	756	VAL	Peptide
1	B	334	VAL	Peptide
1	B	409	GLY	Peptide
1	B	612	ASN	Peptide
1	B	704	TRP	Peptide
1	B	796	HIS	Peptide
1	B	916	THR	Peptide

*Continued on next page...*

*Continued from previous page...*

<b>Mol</b>	<b>Chain</b>	<b>Res</b>	<b>Type</b>	<b>Group</b>
1	C	167	THR	Peptide
1	C	285	ILE	Peptide
1	C	525	ASN	Peptide
1	C	59	ASP	Peptide
1	C	612	ASN	Peptide
1	C	630	PRO	Peptide
1	C	762	ASP	Peptide
1	C	796	HIS	Peptide
1	D	630	PRO	Peptide
1	D	641	PRO	Peptide
1	E	149	PHE	Peptide
1	E	285	ILE	Peptide
1	E	314	TYR	Peptide
1	E	377	ILE	Peptide
1	E	70	PRO	Peptide
1	E	757	PRO	Peptide
1	E	916	THR	Peptide
1	F	397	ALA	Peptide
1	F	419	ALA	Peptide
1	F	617	ASN	Peptide
1	G	273	HIS	Peptide
1	G	286	SER	Peptide
1	G	536	PRO	Peptide
1	G	916	THR	Peptide
1	H	159	GLY	Peptide
1	H	319	GLY	Peptide
1	H	354	GLY	Peptide
1	H	401	THR	Peptide
1	I	384	ASP	Peptide
1	I	536	PRO	Peptide
1	I	618	ASP	Peptide
1	I	70	PRO	Peptide
1	I	796	HIS	Peptide
1	J	224	GLY	Peptide
1	J	292	THR	Peptide
1	J	536	PRO	Peptide
1	J	55	ASP	Peptide
1	J	704	TRP	Peptide
1	J	787	TYR	Peptide
1	K	149	PHE	Peptide
1	K	251	SER	Peptide
1	K	273	HIS	Peptide

*Continued on next page...*

*Continued from previous page...*

Mol	Chain	Res	Type	Group
1	K	288	ALA	Peptide
1	K	289	ASP	Peptide
1	K	536	PRO	Peptide
1	K	704	TRP	Peptide
1	K	796	HIS	Peptide
1	L	174	ASP	Peptide
1	L	630	PRO	Peptide
1	L	641	PRO	Peptide
2	M	100	THR	Peptide
2	M	331	LEU	Peptide
2	M	62	TYR	Peptide

## 5.2 Too-close contacts [i](#)

Due to software issues we are unable to calculate clashes - this section is therefore empty.

## 5.3 Torsion angles [i](#)

### 5.3.1 Protein backbone [i](#)

In the following table, the Percentiles column shows the percent Ramachandran outliers of the chain as a percentile score with respect to all PDB entries followed by that with respect to all EM entries.

The Analysed column shows the number of residues for which the backbone conformation was analysed, and the total number of residues.

Mol	Chain	Analysed	Favoured	Allowed	Outliers	Percentiles	
1	A	908/925 (98%)	776 (86%)	132 (14%)	0	100	100
1	B	909/925 (98%)	780 (86%)	129 (14%)	0	100	100
1	C	910/925 (98%)	792 (87%)	118 (13%)	0	100	100
1	D	904/925 (98%)	759 (84%)	145 (16%)	0	100	100
1	E	913/925 (99%)	779 (85%)	132 (14%)	2 (0%)	47	79
1	F	906/925 (98%)	764 (84%)	139 (15%)	3 (0%)	41	75
1	G	906/925 (98%)	760 (84%)	144 (16%)	2 (0%)	47	79
1	H	911/925 (98%)	761 (84%)	145 (16%)	5 (0%)	29	67
1	I	904/925 (98%)	751 (83%)	151 (17%)	2 (0%)	47	79
1	J	910/925 (98%)	761 (84%)	148 (16%)	1 (0%)	51	84

*Continued on next page...*



Continued from previous page...

Mol	Chain	Analysed	Favoured	Allowed	Outliers	Percentiles	
1	K	908/925 (98%)	760 (84%)	146 (16%)	2 (0%)	47	79
1	L	905/925 (98%)	769 (85%)	136 (15%)	0	100	100
2	M	448/508 (88%)	406 (91%)	42 (9%)	0	100	100
3	N	296/579 (51%)	272 (92%)	24 (8%)	0	100	100
4	O	176/233 (76%)	160 (91%)	16 (9%)	0	100	100
4	P	176/233 (76%)	160 (91%)	16 (9%)	0	100	100
5	Q	48/133 (36%)	39 (81%)	9 (19%)	0	100	100
5	R	48/133 (36%)	39 (81%)	9 (19%)	0	100	100
5	S	48/133 (36%)	39 (81%)	9 (19%)	0	100	100
5	T	48/133 (36%)	39 (81%)	9 (19%)	0	100	100
6	U	27/266 (10%)	26 (96%)	1 (4%)	0	100	100
6	V	27/266 (10%)	26 (96%)	1 (4%)	0	100	100
6	Y	27/266 (10%)	26 (96%)	1 (4%)	0	100	100
6	u	27/266 (10%)	26 (96%)	1 (4%)	0	100	100
7	W	4/183 (2%)	2 (50%)	2 (50%)	0	100	100
7	w	10/183 (6%)	6 (60%)	4 (40%)	0	100	100
All	All	12304/14615 (84%)	10478 (85%)	1809 (15%)	17 (0%)	54	84

All (17) Ramachandran outliers are listed below:

Mol	Chain	Res	Type
1	G	917	PRO
1	H	320	ASN
1	F	630	PRO
1	H	816	PRO
1	E	630	PRO
1	F	385	GLU
1	F	816	PRO
1	K	150	ILE
1	H	665	GLY
1	J	757	PRO
1	E	917	PRO
1	G	287	SER
1	H	148	PRO
1	H	764	MET
1	I	278	PRO

Continued on next page...

*Continued from previous page...*

Mol	Chain	Res	Type
1	I	757	PRO
1	K	757	PRO

### 5.3.2 Protein sidechains [i](#)

In the following table, the Percentiles column shows the percent sidechain outliers of the chain as a percentile score with respect to all PDB entries followed by that with respect to all EM entries.

The Analysed column shows the number of residues for which the sidechain conformation was analysed, and the total number of residues.

Mol	Chain	Analysed	Rotameric	Outliers	Percentiles	
1	A	787/797 (99%)	776 (99%)	11 (1%)	67	81
1	B	788/797 (99%)	779 (99%)	9 (1%)	73	85
1	C	788/797 (99%)	777 (99%)	11 (1%)	67	81
1	D	783/797 (98%)	771 (98%)	12 (2%)	65	80
1	E	790/797 (99%)	780 (99%)	10 (1%)	69	82
1	F	785/797 (98%)	771 (98%)	14 (2%)	59	77
1	G	785/797 (98%)	773 (98%)	12 (2%)	65	80
1	H	789/797 (99%)	776 (98%)	13 (2%)	62	79
1	I	783/797 (98%)	777 (99%)	6 (1%)	81	89
1	J	788/797 (99%)	772 (98%)	16 (2%)	55	73
1	K	787/797 (99%)	776 (99%)	11 (1%)	67	81
1	L	787/797 (99%)	779 (99%)	8 (1%)	76	86
2	M	403/447 (90%)	398 (99%)	5 (1%)	71	84
3	N	253/501 (50%)	251 (99%)	2 (1%)	81	89
4	O	149/193 (77%)	147 (99%)	2 (1%)	69	82
4	P	149/193 (77%)	147 (99%)	2 (1%)	69	82
5	Q	38/97 (39%)	36 (95%)	2 (5%)	22	51
5	R	38/97 (39%)	36 (95%)	2 (5%)	22	51
5	S	38/97 (39%)	36 (95%)	2 (5%)	22	51
5	T	38/97 (39%)	36 (95%)	2 (5%)	22	51
6	U	22/227 (10%)	22 (100%)	0	100	100
6	V	22/227 (10%)	22 (100%)	0	100	100

*Continued on next page...*

*Continued from previous page...*

Mol	Chain	Analysed	Rotameric	Outliers	Percentiles	
6	Y	22/227 (10%)	22 (100%)	0	100	100
6	u	22/227 (10%)	22 (100%)	0	100	100
7	W	2/139 (1%)	2 (100%)	0	100	100
7	w	6/139 (4%)	6 (100%)	0	100	100
All	All	10642/12472 (85%)	10490 (99%)	152 (1%)	68	81

All (152) residues with a non-rotameric sidechain are listed below:

Mol	Chain	Res	Type
1	A	47	ASN
1	A	138	ASN
1	A	155	ASN
1	A	156	LYS
1	A	218	LYS
1	A	308	ASN
1	A	408	ASN
1	A	417	ASN
1	A	538	LYS
1	A	776	ARG
1	A	810	ARG
1	B	153	ASN
1	B	218	LYS
1	B	308	ASN
1	B	367	VAL
1	B	408	ASN
1	B	417	ASN
1	B	625	MET
1	B	810	ARG
1	B	818	ASN
1	C	6	MET
1	C	47	ASN
1	C	83	ARG
1	C	158	ASN
1	C	218	LYS
1	C	308	ASN
1	C	335	VAL
1	C	625	MET
1	C	774	MET
1	C	810	ARG
1	C	835	LYS
1	D	7	MET

*Continued on next page...*

*Continued from previous page...*

<b>Mol</b>	<b>Chain</b>	<b>Res</b>	<b>Type</b>
1	D	92	ARG
1	D	122	ASN
1	D	138	ASN
1	D	153	ASN
1	D	243	ASN
1	D	308	ASN
1	D	388	ASN
1	D	644	ASN
1	D	797	ASN
1	D	810	ARG
1	D	869	ASN
1	E	88	VAL
1	E	153	ASN
1	E	232	ASN
1	E	388	ASN
1	E	478	ASN
1	E	572	ASN
1	E	617	ASN
1	E	798	ASN
1	E	810	ARG
1	E	864	ASN
1	F	6	MET
1	F	67	ARG
1	F	168	ASN
1	F	323	VAL
1	F	335	VAL
1	F	341	ASN
1	F	408	ASN
1	F	417	ASN
1	F	436	ASN
1	F	478	ASN
1	F	609	ASN
1	F	632	ASN
1	F	774	MET
1	F	810	ARG
1	G	47	ASN
1	G	142	LYS
1	G	144	ARG
1	G	308	ASN
1	G	341	ASN
1	G	388	ASN
1	G	408	ASN

*Continued on next page...*

*Continued from previous page...*

<b>Mol</b>	<b>Chain</b>	<b>Res</b>	<b>Type</b>
1	G	470	ASN
1	G	478	ASN
1	G	598	ASN
1	G	774	MET
1	G	810	ARG
1	H	136	LYS
1	H	153	ASN
1	H	158	ASN
1	H	308	ASN
1	H	341	ASN
1	H	388	ASN
1	H	399	THR
1	H	408	ASN
1	H	421	ARG
1	H	470	ASN
1	H	797	ASN
1	H	798	ASN
1	H	810	ARG
1	I	144	ARG
1	I	324	LEU
1	I	341	ASN
1	I	417	ASN
1	I	810	ARG
1	I	864	ASN
1	J	6	MET
1	J	144	ARG
1	J	153	ASN
1	J	155	ASN
1	J	158	ASN
1	J	168	ASN
1	J	308	ASN
1	J	341	ASN
1	J	379	ASN
1	J	470	ASN
1	J	563	ASN
1	J	572	ASN
1	J	636	VAL
1	J	774	MET
1	J	810	ARG
1	J	861	LEU
1	K	43	ASN
1	K	67	ARG

*Continued on next page...*

*Continued from previous page...*

Mol	Chain	Res	Type
1	K	144	ARG
1	K	242	VAL
1	K	308	ASN
1	K	341	ASN
1	K	436	ASN
1	K	470	ASN
1	K	478	ASN
1	K	810	ARG
1	K	864	ASN
1	L	122	ASN
1	L	221	ASN
1	L	341	ASN
1	L	644	ASN
1	L	649	ARG
1	L	714	ASN
1	L	780	ASN
1	L	810	ARG
2	M	126	ARG
2	M	131	ASN
2	M	223	MET
2	M	238	LEU
2	M	486	ARG
3	N	49	ASN
3	N	201	ARG
4	O	32	ASN
4	O	171	ARG
4	P	32	ASN
4	P	171	ARG
5	Q	39	ASN
5	Q	43	ARG
5	R	39	ASN
5	R	43	ARG
5	S	39	ASN
5	S	43	ARG
5	T	39	ASN
5	T	43	ARG

Sometimes sidechains can be flipped to improve hydrogen bonding and reduce clashes. All (273) such sidechains are listed below:

Mol	Chain	Res	Type
1	A	18	GLN
1	A	47	ASN

*Continued on next page...*

*Continued from previous page...*

<b>Mol</b>	<b>Chain</b>	<b>Res</b>	<b>Type</b>
1	A	54	HIS
1	A	91	ASN
1	A	138	ASN
1	A	155	ASN
1	A	161	GLN
1	A	178	GLN
1	A	308	ASN
1	A	330	GLN
1	A	347	GLN
1	A	408	ASN
1	A	417	ASN
1	A	440	ASN
1	A	509	ASN
1	A	557	ASN
1	A	591	ASN
1	A	612	ASN
1	A	624	ASN
1	A	688	ASN
1	A	746	HIS
1	A	752	GLN
1	A	813	GLN
1	A	872	HIS
1	B	18	GLN
1	B	54	HIS
1	B	146	GLN
1	B	153	ASN
1	B	155	ASN
1	B	308	ASN
1	B	380	HIS
1	B	388	ASN
1	B	408	ASN
1	B	417	ASN
1	B	506	ASN
1	B	509	ASN
1	B	537	GLN
1	B	567	GLN
1	B	609	ASN
1	B	612	ASN
1	B	624	ASN
1	B	746	HIS
1	B	772	GLN
1	B	777	GLN

*Continued on next page...*

*Continued from previous page...*

<b>Mol</b>	<b>Chain</b>	<b>Res</b>	<b>Type</b>
1	B	834	GLN
1	C	47	ASN
1	C	155	ASN
1	C	158	ASN
1	C	185	GLN
1	C	187	GLN
1	C	308	ASN
1	C	347	GLN
1	C	388	ASN
1	C	429	ASN
1	C	440	ASN
1	C	510	HIS
1	C	532	HIS
1	C	624	ASN
1	C	632	ASN
1	C	742	GLN
1	C	772	GLN
1	C	780	ASN
1	C	813	GLN
1	C	834	GLN
1	C	872	HIS
1	D	54	HIS
1	D	122	ASN
1	D	138	ASN
1	D	153	ASN
1	D	155	ASN
1	D	178	GLN
1	D	243	ASN
1	D	282	GLN
1	D	293	GLN
1	D	308	ASN
1	D	365	GLN
1	D	388	ASN
1	D	537	GLN
1	D	612	ASN
1	D	624	ASN
1	D	644	ASN
1	D	714	ASN
1	D	742	GLN
1	D	746	HIS
1	D	748	ASN
1	D	777	GLN

*Continued on next page...*



*Continued from previous page...*

<b>Mol</b>	<b>Chain</b>	<b>Res</b>	<b>Type</b>
1	D	780	ASN
1	D	797	ASN
1	D	813	GLN
1	D	869	ASN
1	E	14	HIS
1	E	122	ASN
1	E	153	ASN
1	E	155	ASN
1	E	232	ASN
1	E	320	ASN
1	E	330	GLN
1	E	341	ASN
1	E	388	ASN
1	E	440	ASN
1	E	537	GLN
1	E	587	ASN
1	E	597	HIS
1	E	624	ASN
1	E	632	ASN
1	E	688	ASN
1	E	746	HIS
1	E	752	GLN
1	E	780	ASN
1	E	834	GLN
1	E	863	GLN
1	E	864	ASN
1	F	54	HIS
1	F	62	GLN
1	F	146	GLN
1	F	155	ASN
1	F	168	ASN
1	F	178	GLN
1	F	226	GLN
1	F	298	ASN
1	F	308	ASN
1	F	341	ASN
1	F	347	GLN
1	F	417	ASN
1	F	478	ASN
1	F	506	ASN
1	F	509	ASN
1	F	609	ASN

*Continued on next page...*

*Continued from previous page...*

<b>Mol</b>	<b>Chain</b>	<b>Res</b>	<b>Type</b>
1	F	612	ASN
1	F	632	ASN
1	F	731	GLN
1	F	772	GLN
1	F	777	GLN
1	F	834	GLN
1	G	9	GLN
1	G	47	ASN
1	G	146	GLN
1	G	178	GLN
1	G	226	GLN
1	G	298	ASN
1	G	308	ASN
1	G	341	ASN
1	G	388	ASN
1	G	408	ASN
1	G	449	ASN
1	G	464	ASN
1	G	470	ASN
1	G	478	ASN
1	G	537	GLN
1	G	572	ASN
1	G	587	ASN
1	G	598	ASN
1	G	742	GLN
1	G	746	HIS
1	G	770	ASN
1	G	788	GLN
1	G	795	GLN
1	G	796	HIS
1	H	153	ASN
1	H	158	ASN
1	H	185	GLN
1	H	226	GLN
1	H	264	ASN
1	H	341	ASN
1	H	408	ASN
1	H	440	ASN
1	H	591	ASN
1	H	742	GLN
1	H	770	ASN
1	H	777	GLN

*Continued on next page...*

*Continued from previous page...*

<b>Mol</b>	<b>Chain</b>	<b>Res</b>	<b>Type</b>
1	H	797	ASN
1	H	813	GLN
1	H	872	HIS
1	I	54	HIS
1	I	182	GLN
1	I	185	GLN
1	I	189	ASN
1	I	245	GLN
1	I	316	ASN
1	I	341	ASN
1	I	380	HIS
1	I	417	ASN
1	I	510	HIS
1	I	557	ASN
1	I	624	ASN
1	I	746	HIS
1	I	777	GLN
1	I	798	ASN
1	I	864	ASN
1	J	54	HIS
1	J	122	ASN
1	J	153	ASN
1	J	155	ASN
1	J	158	ASN
1	J	161	GLN
1	J	168	ASN
1	J	178	GLN
1	J	245	GLN
1	J	254	ASN
1	J	294	GLN
1	J	298	ASN
1	J	308	ASN
1	J	330	GLN
1	J	341	ASN
1	J	379	ASN
1	J	470	ASN
1	J	478	ASN
1	J	510	HIS
1	J	614	GLN
1	J	624	ASN
1	J	632	ASN
1	J	742	GLN

*Continued on next page...*

*Continued from previous page...*

<b>Mol</b>	<b>Chain</b>	<b>Res</b>	<b>Type</b>
1	K	9	GLN
1	K	54	HIS
1	K	178	GLN
1	K	298	ASN
1	K	341	ASN
1	K	470	ASN
1	K	472	ASN
1	K	478	ASN
1	K	509	ASN
1	K	557	ASN
1	K	612	ASN
1	K	624	ASN
1	K	632	ASN
1	K	688	ASN
1	K	798	ASN
1	K	864	ASN
1	K	902	HIS
1	L	146	GLN
1	L	169	GLN
1	L	185	GLN
1	L	196	GLN
1	L	221	ASN
1	L	327	GLN
1	L	332	ASN
1	L	338	GLN
1	L	341	ASN
1	L	347	GLN
1	L	365	GLN
1	L	440	ASN
1	L	464	ASN
1	L	537	GLN
1	L	591	ASN
1	L	624	ASN
1	L	632	ASN
1	L	644	ASN
1	L	707	ASN
1	L	780	ASN
1	L	797	ASN
1	L	798	ASN
1	L	813	GLN
2	M	86	HIS
2	M	90	GLN

*Continued on next page...*

*Continued from previous page...*

Mol	Chain	Res	Type
2	M	181	ASN
2	M	187	ASN
2	M	372	GLN
2	M	463	HIS
2	M	476	GLN
3	N	49	ASN
3	N	215	ASN
4	O	14	GLN
4	O	16	GLN
4	O	25	GLN
4	O	32	ASN
4	O	53	GLN
4	O	58	GLN
4	P	25	GLN
4	P	32	ASN
5	Q	39	ASN
5	R	39	ASN
5	S	39	ASN
5	T	39	ASN

### 5.3.3 RNA [i](#)

There are no RNA molecules in this entry.

### 5.4 Non-standard residues in protein, DNA, RNA chains [i](#)

There are no non-standard protein/DNA/RNA residues in this entry.

### 5.5 Carbohydrates [i](#)

There are no monosaccharides in this entry.

### 5.6 Ligand geometry [i](#)

There are no ligands in this entry.

### 5.7 Other polymers [i](#)

There are no such residues in this entry.

## 5.8 Polymer linkage issues

There are no chain breaks in this entry.

## 6 Map visualisation [i](#)

This section contains visualisations of the EMDB entry EMD-10768. These allow visual inspection of the internal detail of the map and identification of artifacts.

No raw map or half-maps were deposited for this entry and therefore no images, graphs, etc. pertaining to the raw map can be shown.

### 6.1 Orthogonal projections [i](#)

#### 6.1.1 Primary map

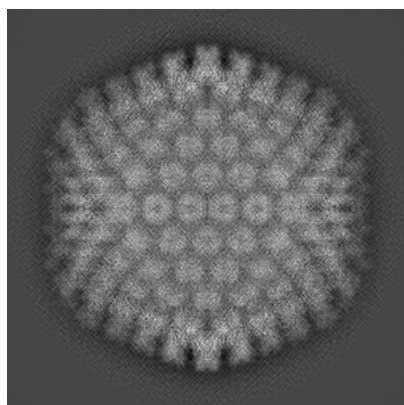

X

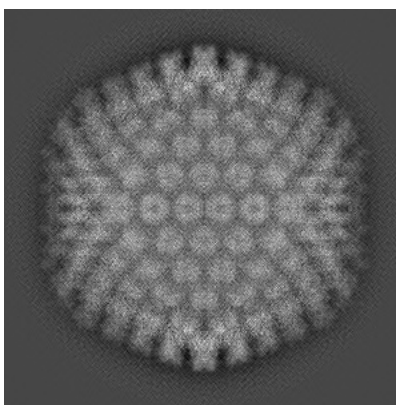

Y

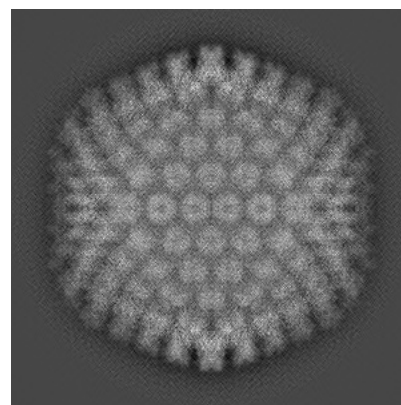

Z

The images above show the map projected in three orthogonal directions.

### 6.2 Central slices [i](#)

#### 6.2.1 Primary map

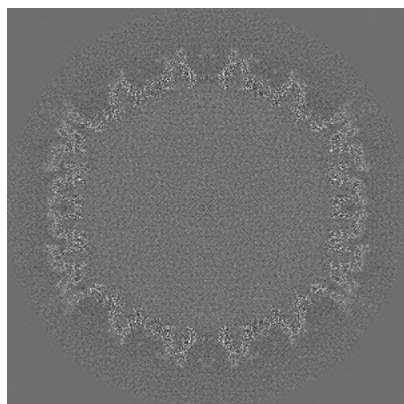

X Index: 390

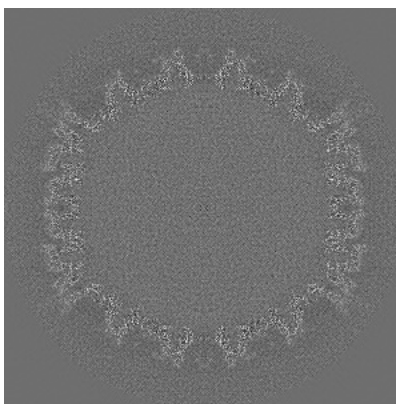

Y Index: 390

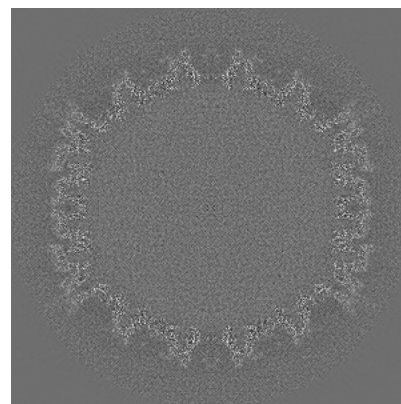

Z Index: 390

The images above show central slices of the map in three orthogonal directions.

## 6.3 Largest variance slices [i](#)

### 6.3.1 Primary map

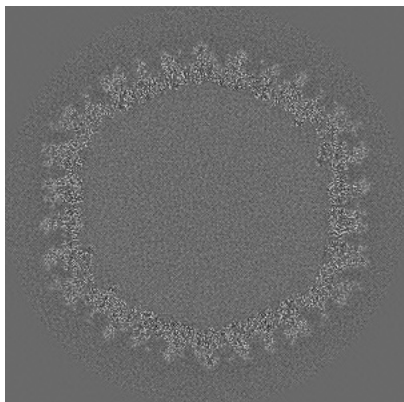

X Index: 405

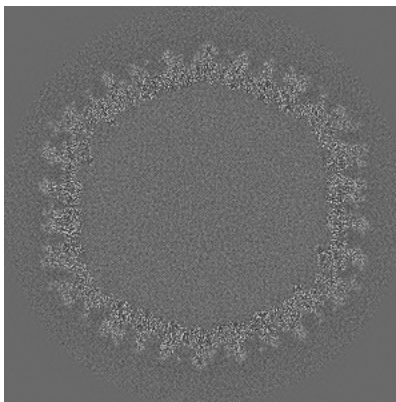

Y Index: 375

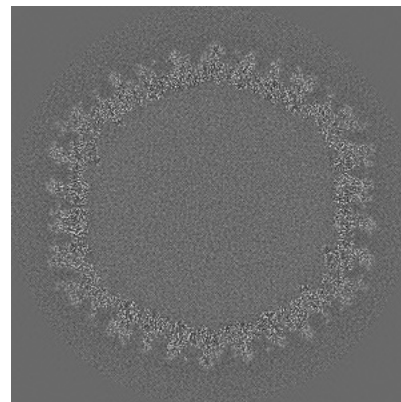

Z Index: 375

The images above show the largest variance slices of the map in three orthogonal directions.

## 6.4 Orthogonal surface views [i](#)

### 6.4.1 Primary map

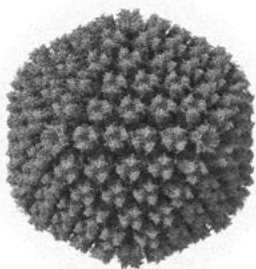

X



Y

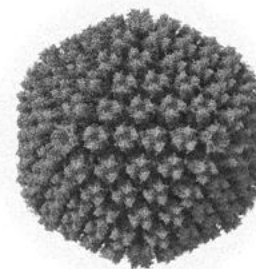

Z

The images above show the 3D surface view of the map at the recommended contour level 0.07. These images, in conjunction with the slice images, may facilitate assessment of whether an appropriate contour level has been provided.



## 6.5 Mask visualisation

This section was not generated. No masks/segmentation were deposited.

## 7 Map analysis [i](#)

This section contains the results of statistical analysis of the map.

### 7.1 Map-value distribution [i](#)

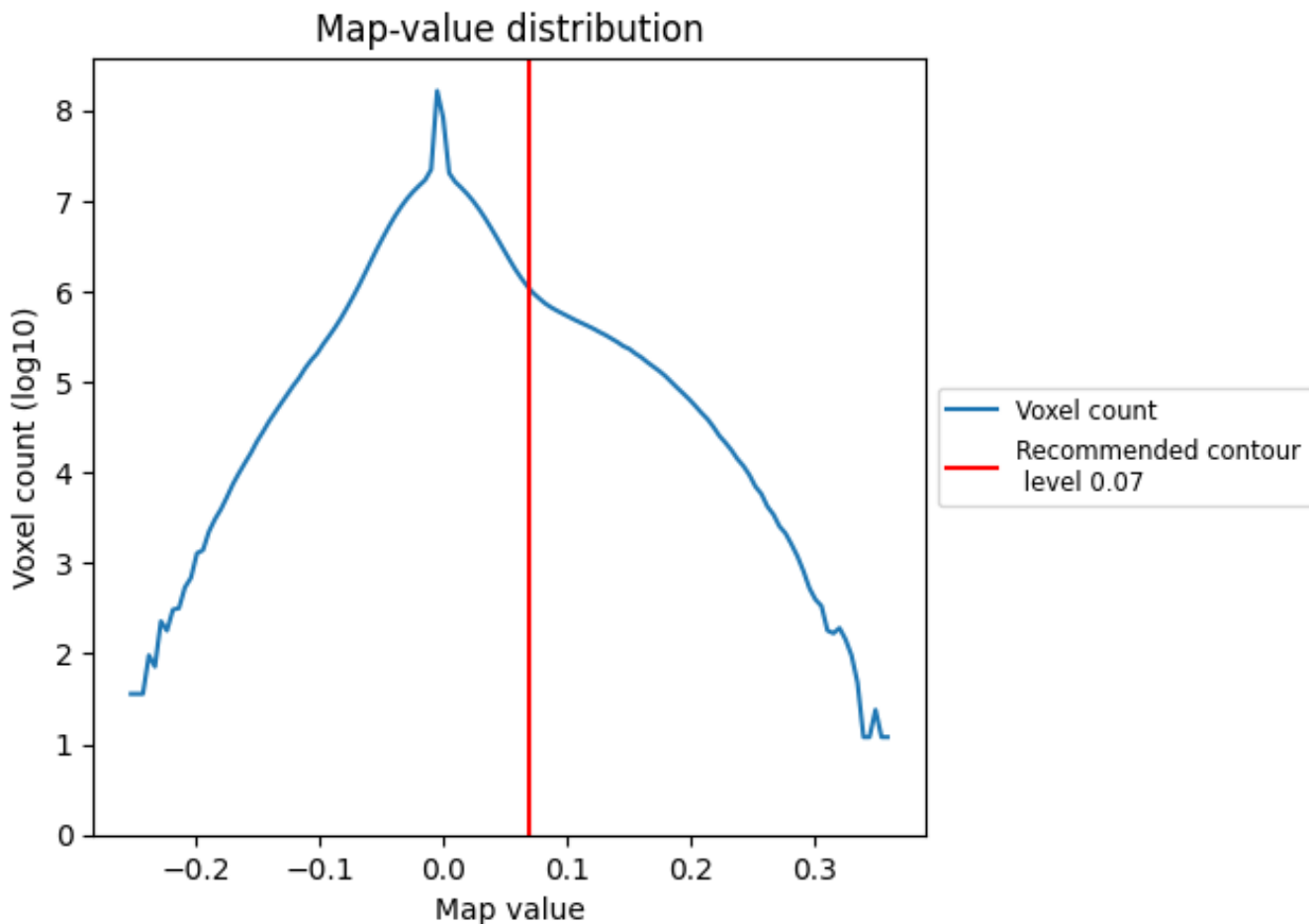

The map-value distribution is plotted in 128 intervals along the x-axis. The y-axis is logarithmic. A spike in this graph at zero usually indicates that the volume has been masked.

## 7.2 Volume estimate [\(i\)](#)

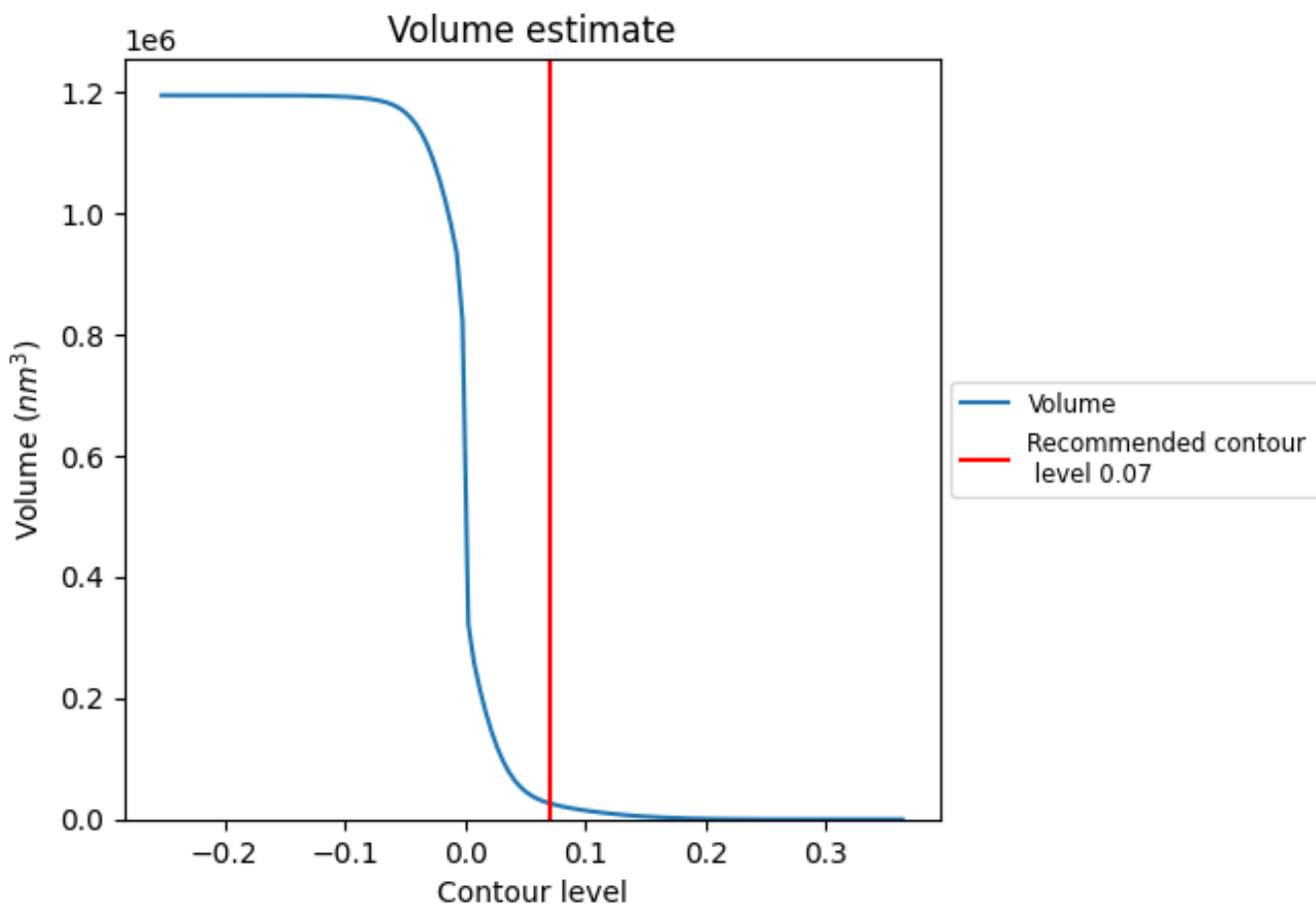

The volume at the recommended contour level is 26562 nm<sup>3</sup>; this corresponds to an approximate mass of 23994 kDa.

The volume estimate graph shows how the enclosed volume varies with the contour level. The recommended contour level is shown as a vertical line and the intersection between the line and the curve gives the volume of the enclosed surface at the given level.

### 7.3 Rotationally averaged power spectrum [i](#)

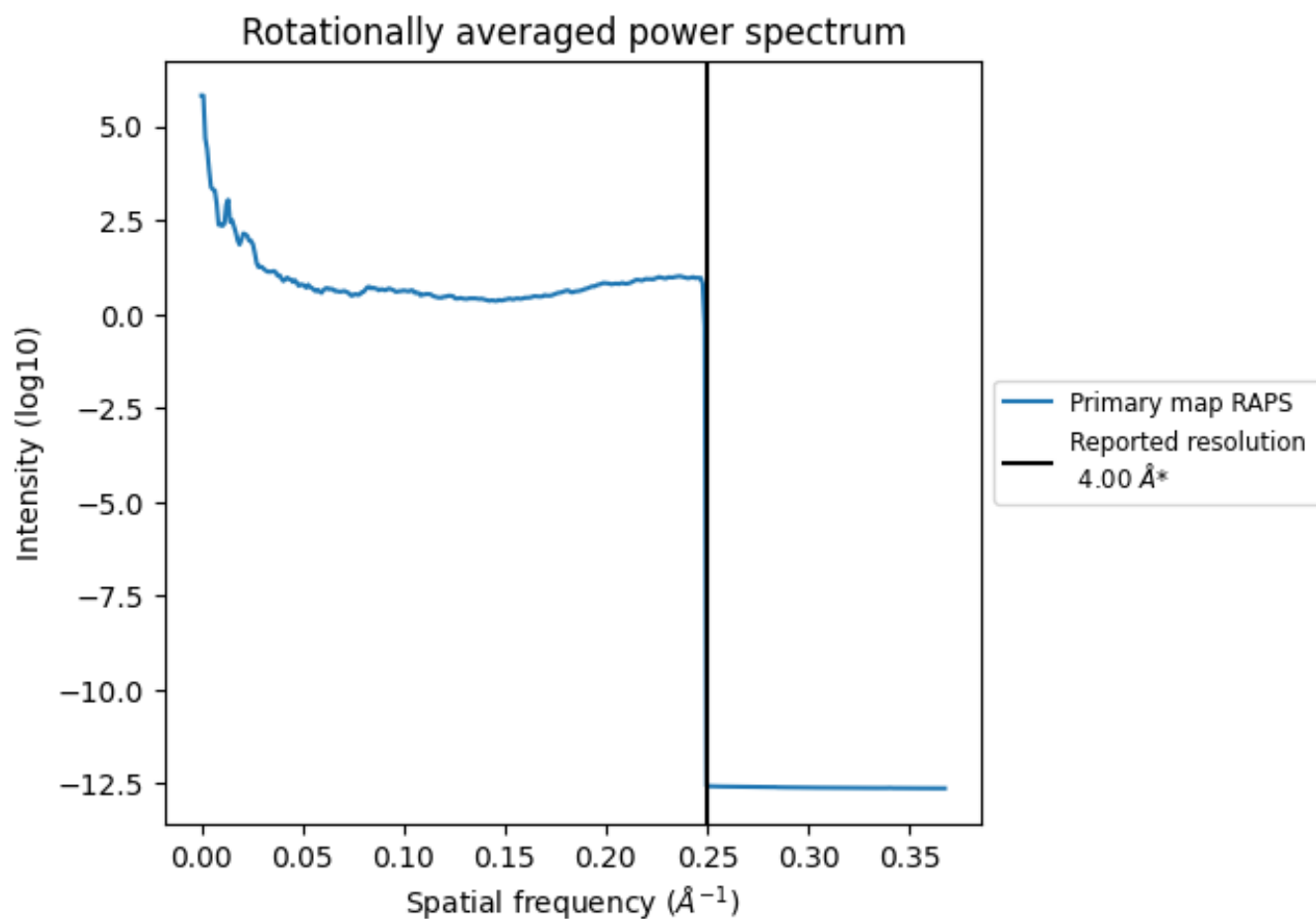

\*Reported resolution corresponds to spatial frequency of 0.250 Å<sup>-1</sup>

## 8 Fourier-Shell correlation

This section was not generated. No FSC curve or half-maps provided.

## 9 Map-model fit [i](#)

This section contains information regarding the fit between EMDB map EMD-10768 and PDB model 6YBA. Per-residue inclusion information can be found in section 3 on page 6.

### 9.1 Map-model overlay [i](#)

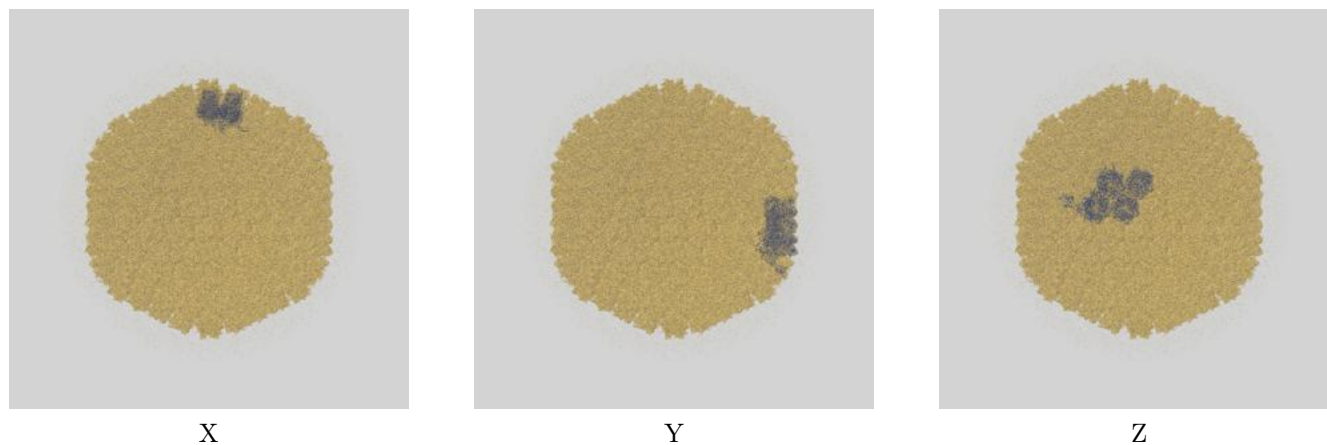

The images above show the 3D surface view of the map at the recommended contour level 0.07 at 50% transparency in yellow overlaid with a ribbon representation of the model coloured in blue. These images allow for the visual assessment of the quality of fit between the atomic model and the map.

## 9.2 Q-score mapped to coordinate model [i](#)

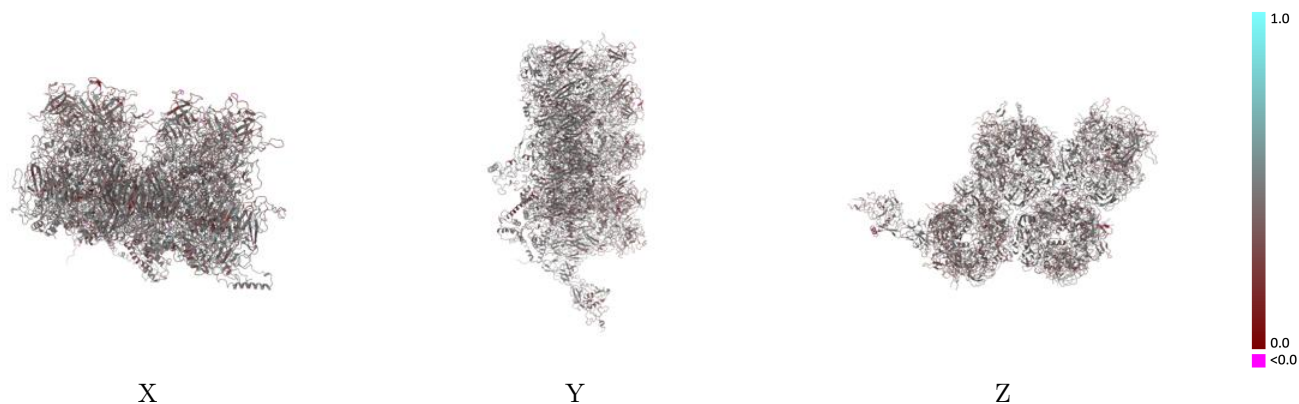

The images above show the model with each residue coloured according its Q-score. This shows their resolvability in the map with higher Q-score values reflecting better resolvability. Please note: Q-score is calculating the resolvability of atoms, and thus high values are only expected at resolutions at which atoms can be resolved. Low Q-score values may therefore be expected for many entries.

## 9.3 Atom inclusion mapped to coordinate model [i](#)

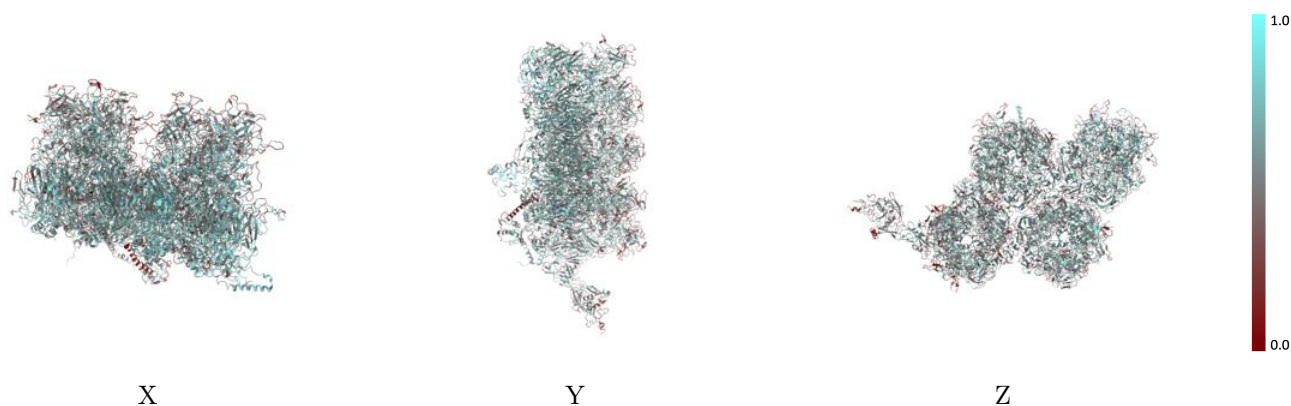

The images above show the model with each residue coloured according to its atom inclusion. This shows to what extent they are inside the map at the recommended contour level (0.07).

## 9.4 Atom inclusion [i](#)

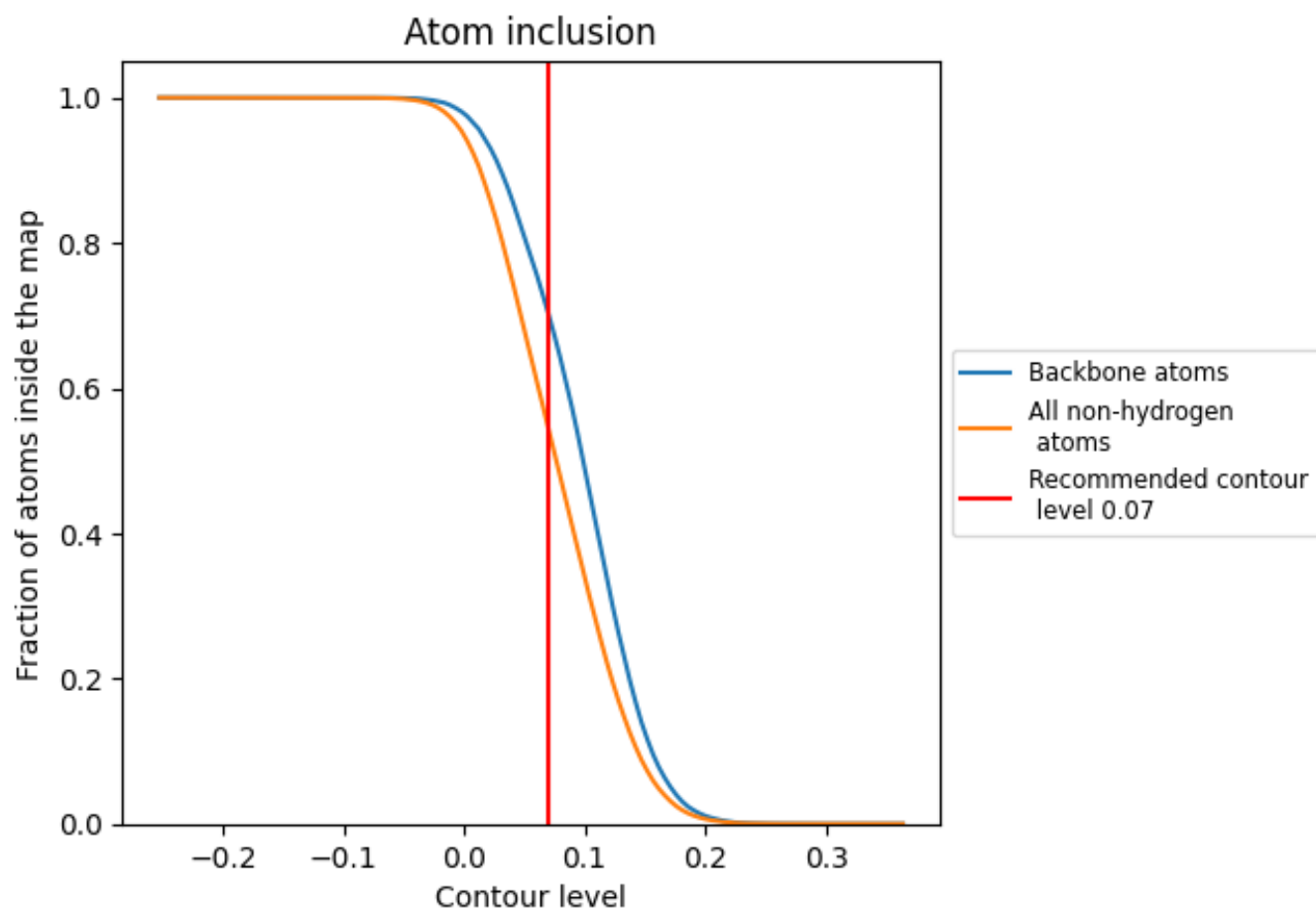























































At the recommended contour level, 70% of all backbone atoms, 55% of all non-hydrogen atoms, are inside the map.



## 9.5 Map-model fit summary

The table lists the average atom inclusion at the recommended contour level (0.07) and Q-score for the entire model and for each chain.

Chain	Atom inclusion	Q-score
All	 0.5453	 0.4130
A	 0.5394	 0.4080
B	 0.5218	 0.4020
C	 0.5325	 0.4040
D	 0.5647	 0.4140
E	 0.5448	 0.4090
F	 0.5534	 0.4110
G	 0.5691	 0.4210
H	 0.5744	 0.4190
I	 0.5825	 0.4240
J	 0.5486	 0.4180
K	 0.5559	 0.4120
L	 0.5661	 0.4180
M	 0.4578	 0.4120
N	 0.4289	 0.4070
O	 0.5723	 0.4280
P	 0.5789	 0.4410
Q	 0.5084	 0.4170
R	 0.4635	 0.3940
S	 0.5000	 0.4060
T	 0.5365	 0.4130
U	 0.1831	 0.2820
V	 0.4272	 0.3870
W	 0.3333	 0.4110
Y	 0.4930	 0.3990
u	 0.1643	 0.2870
w	 0.3086	 0.3870

