



Full wwPDB EM Validation Report ⓘ

Oct 31, 2024 – 03:20 PM EDT

PDB ID : 6X33
EMDB ID : EMD-22016
Title : Wt pig RyR1 in complex with apoCaM, EGTA condition (class 3, open)
Authors : Woll, K.W.; Haji-Ghassemi, O.; Van Petegem, F.
Deposited on : 2020-05-21
Resolution : 4.20 Å (reported)

This is a Full wwPDB EM Validation Report for a publicly released PDB entry.

We welcome your comments at validation@mail.wwpdb.org

A user guide is available at

<https://www.wwpdb.org/validation/2017/EMValidationReportHelp>

with specific help available everywhere you see the ⓘ symbol.

The types of validation reports are described at

<http://www.wwpdb.org/validation/2017/FAQs#types>.

The following versions of software and data (see [references ⓘ](#)) were used in the production of this report:

EMDB validation analysis : 0.0.1.dev113
MolProbity : 4.02b-467
Percentile statistics : 20231227.v01 (using entries in the PDB archive December 27th 2023)
MapQ : 1.9.13
Ideal geometry (proteins) : Engh & Huber (2001)
Ideal geometry (DNA, RNA) : Parkinson et al. (1996)
Validation Pipeline (wwPDB-VP) : 2.39

1 Overall quality at a glance

The following experimental techniques were used to determine the structure:
ELECTRON MICROSCOPY

The reported resolution of this entry is 4.20 Å.

Percentile scores (ranging between 0-100) for global validation metrics of the entry are shown in the following graphic. The table shows the number of entries on which the scores are based.

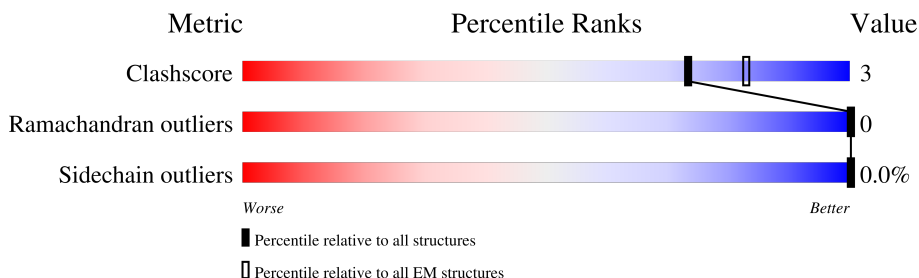





| Metric | Whole archive (#Entries) | EM structures (#Entries) |
|-----------------------|--------------------------|--------------------------|
| Clashscore | 210492 | 15764 |
| Ramachandran outliers | 207382 | 16835 |
| Sidechain outliers | 206894 | 16415 |

The table below summarises the geometric issues observed across the polymeric chains and their fit to the map. The red, orange, yellow and green segments of the bar indicate the fraction of residues that contain outliers for ≥ 3 , 2, 1 and 0 types of geometric quality criteria respectively. A grey segment represents the fraction of residues that are not modelled. The numeric value for each fraction is indicated below the corresponding segment, with a dot representing fractions $\leq 5\%$. The upper red bar (where present) indicates the fraction of residues that have poor fit to the EM map (all-atom inclusion $< 40\%$). The numeric value is given above the bar.

| Mol | Chain | Length | Quality of chain |
|-----|-------|--------|---|
| 1 | A | 107 | 19% (red), 89% (green), 10% (yellow), 2% (grey) |
| 1 | D | 107 | 19% (red), 89% (green), 10% (yellow), 2% (grey) |
| 1 | G | 107 | 20% (red), 89% (green), 10% (yellow), 2% (grey) |
| 1 | J | 107 | 19% (red), 89% (green), 10% (yellow), 2% (grey) |
| 2 | B | 3816 | 32% (red), 93% (green), 7% (yellow), 2% (grey) |
| 2 | E | 3816 | 32% (red), 93% (green), 7% (yellow), 2% (grey) |
| 2 | H | 3816 | 32% (red), 93% (green), 7% (yellow), 2% (grey) |
| 2 | K | 3816 | 32% (red), 93% (green), 7% (yellow), 2% (grey) |

Continued on next page...

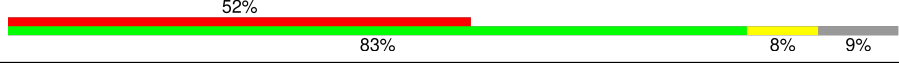
Continued from previous page...

| Mol | Chain | Length | Quality of chain |
|-----|-------|--------|--|
| 3 | C | 148 |  |
| 3 | F | 148 |  |
| 3 | I | 148 |  |
| 3 | L | 148 |  |

2 Entry composition [i](#)

There are 4 unique types of molecules in this entry. The entry contains 112372 atoms, of which 0 are hydrogens and 0 are deuteriums.

In the tables below, the AltConf column contains the number of residues with at least one atom in alternate conformation and the Trace column contains the number of residues modelled with at most 2 atoms.

- Molecule 1 is a protein called Peptidyl-prolyl cis-trans isomerase FKBP1B.

| Mol | Chain | Residues | Atoms | | | | | AltConf | Trace |
|-----|-------|----------|-------|-----|-----|-----|---|---------|-------|
| | | | Total | C | N | O | S | | |
| 1 | A | 106 | 727 | 460 | 124 | 139 | 4 | 0 | 0 |
| 1 | D | 106 | 727 | 460 | 124 | 139 | 4 | 0 | 0 |
| 1 | G | 106 | 727 | 460 | 124 | 139 | 4 | 0 | 0 |
| 1 | J | 106 | 727 | 460 | 124 | 139 | 4 | 0 | 0 |

- Molecule 2 is a protein called Ryanodine Receptor.

| Mol | Chain | Residues | Atoms | | | | | AltConf | Trace |
|-----|-------|----------|-------|-------|------|------|-----|---------|-------|
| | | | Total | C | N | O | S | | |
| 2 | B | 3816 | 26597 | 17002 | 4711 | 4735 | 149 | 6 | 0 |
| 2 | E | 3816 | 26597 | 17002 | 4711 | 4735 | 149 | 6 | 0 |
| 2 | H | 3816 | 26597 | 17002 | 4711 | 4735 | 149 | 6 | 0 |
| 2 | K | 3816 | 26597 | 17002 | 4711 | 4735 | 149 | 6 | 0 |

- Molecule 3 is a protein called Calmodulin-1.

| Mol | Chain | Residues | Atoms | | | | | AltConf | Trace |
|-----|-------|----------|-------|-----|-----|-----|---|---------|-------|
| | | | Total | C | N | O | S | | |
| 3 | C | 135 | 768 | 477 | 138 | 151 | 2 | 0 | 0 |
| 3 | F | 135 | 768 | 477 | 138 | 151 | 2 | 0 | 0 |
| 3 | I | 135 | 768 | 477 | 138 | 151 | 2 | 0 | 0 |
| 3 | L | 135 | 768 | 477 | 138 | 151 | 2 | 0 | 0 |

- Molecule 4 is ZINC ION (three-letter code: ZN) (formula: Zn).

| Mol | Chain | Residues | Atoms | | AltConf |
|------------|--------------|-----------------|--------------|---------|----------------|
| 4 | B | 1 | Total 1 | Zn 1 | 0 |
| 4 | E | 1 | Total 1 | Zn 1 | 0 |
| 4 | H | 1 | Total 1 | Zn 1 | 0 |
| 4 | K | 1 | Total 1 | Zn 1 | 0 |

3 Residue-property plots [i](#)

These plots are drawn for all protein, RNA, DNA and oligosaccharide chains in the entry. The first graphic for a chain summarises the proportions of the various outlier classes displayed in the second graphic. The second graphic shows the sequence view annotated by issues in geometry and atom inclusion in map density. Residues are color-coded according to the number of geometric quality criteria for which they contain at least one outlier: green = 0, yellow = 1, orange = 2 and red = 3 or more. A red diamond above a residue indicates a poor fit to the EM map for this residue (all-atom inclusion < 40%). Stretches of 2 or more consecutive residues without any outlier are shown as a green connector. Residues present in the sample, but not in the model, are shown in grey.

- Molecule 1: Peptidyl-prolyl cis-trans isomerase FKBP1B

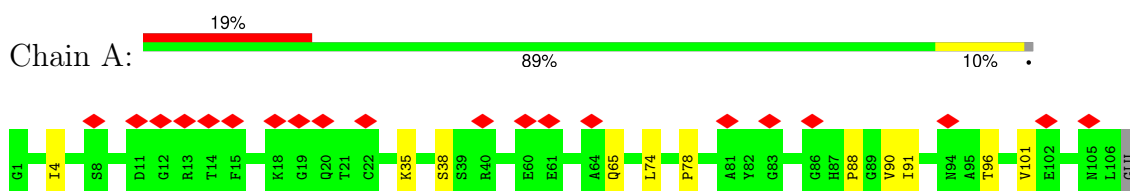

- Molecule 1: Peptidyl-prolyl cis-trans isomerase FKBP1B

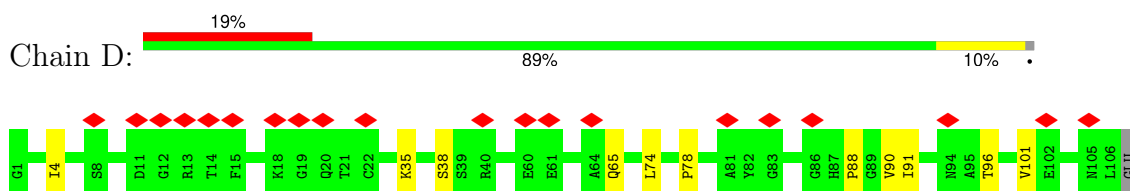

- Molecule 1: Peptidyl-prolyl cis-trans isomerase FKBP1B

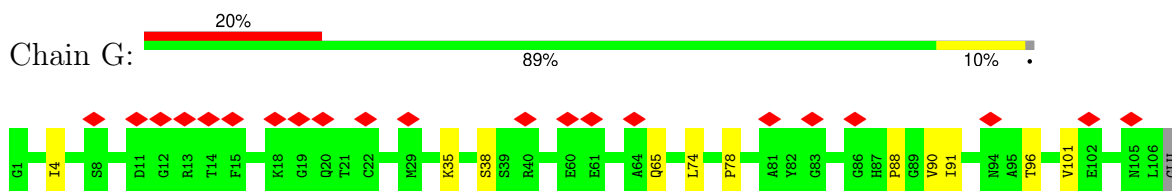

- Molecule 1: Peptidyl-prolyl cis-trans isomerase FKBP1B

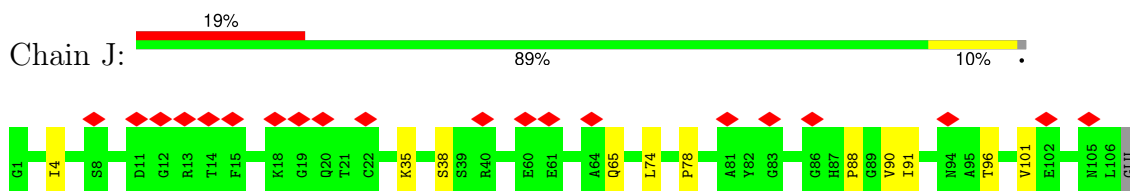

- Molecule 2: Ryanodine Receptor

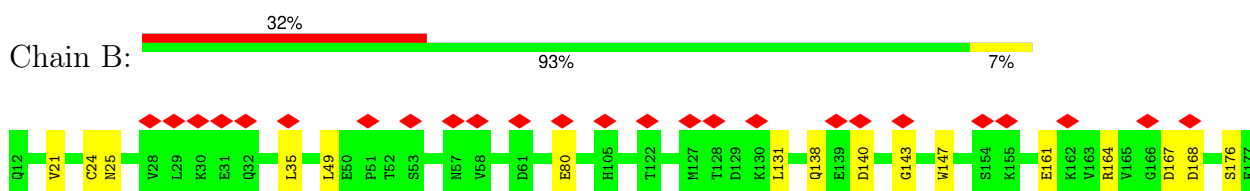

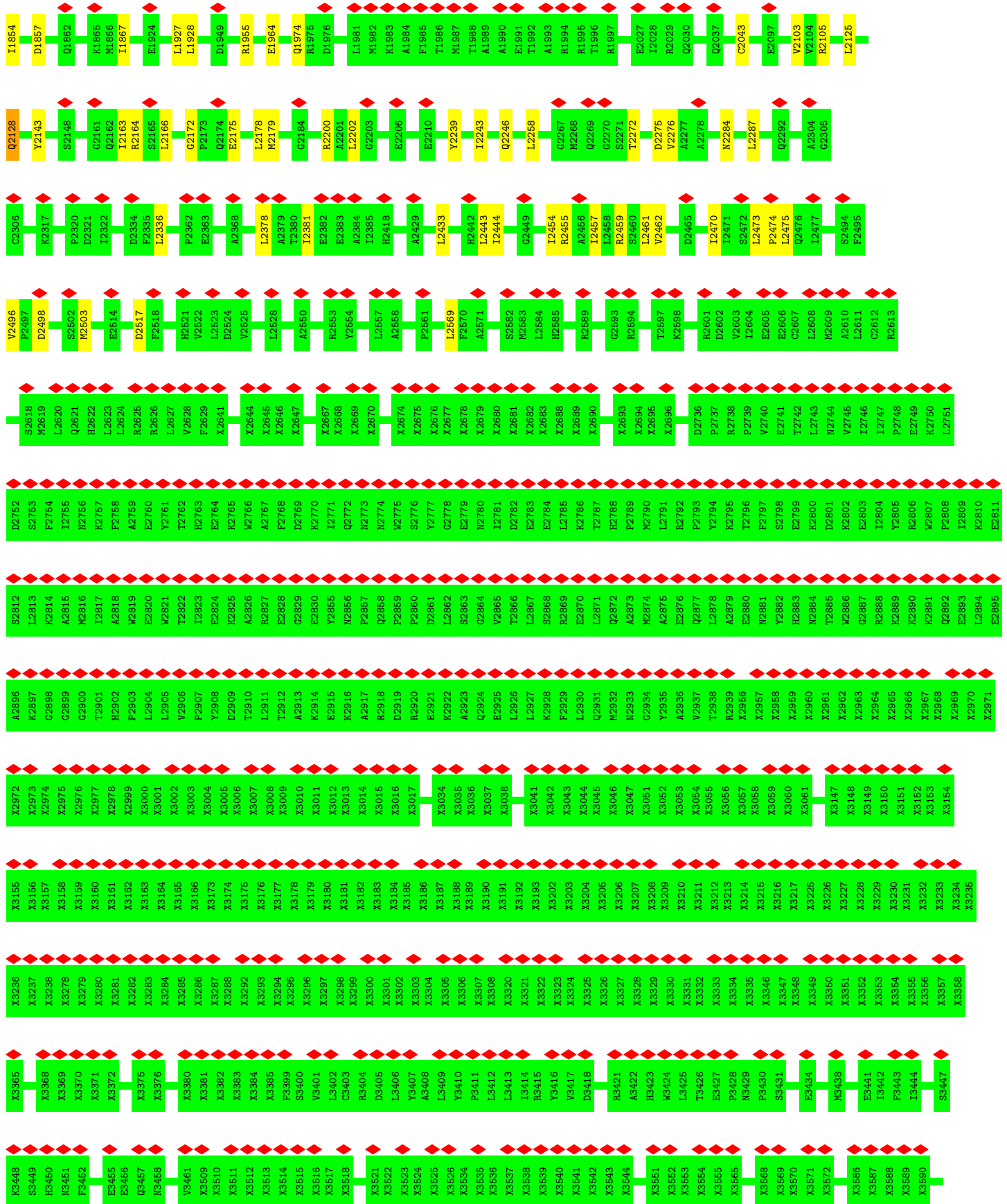

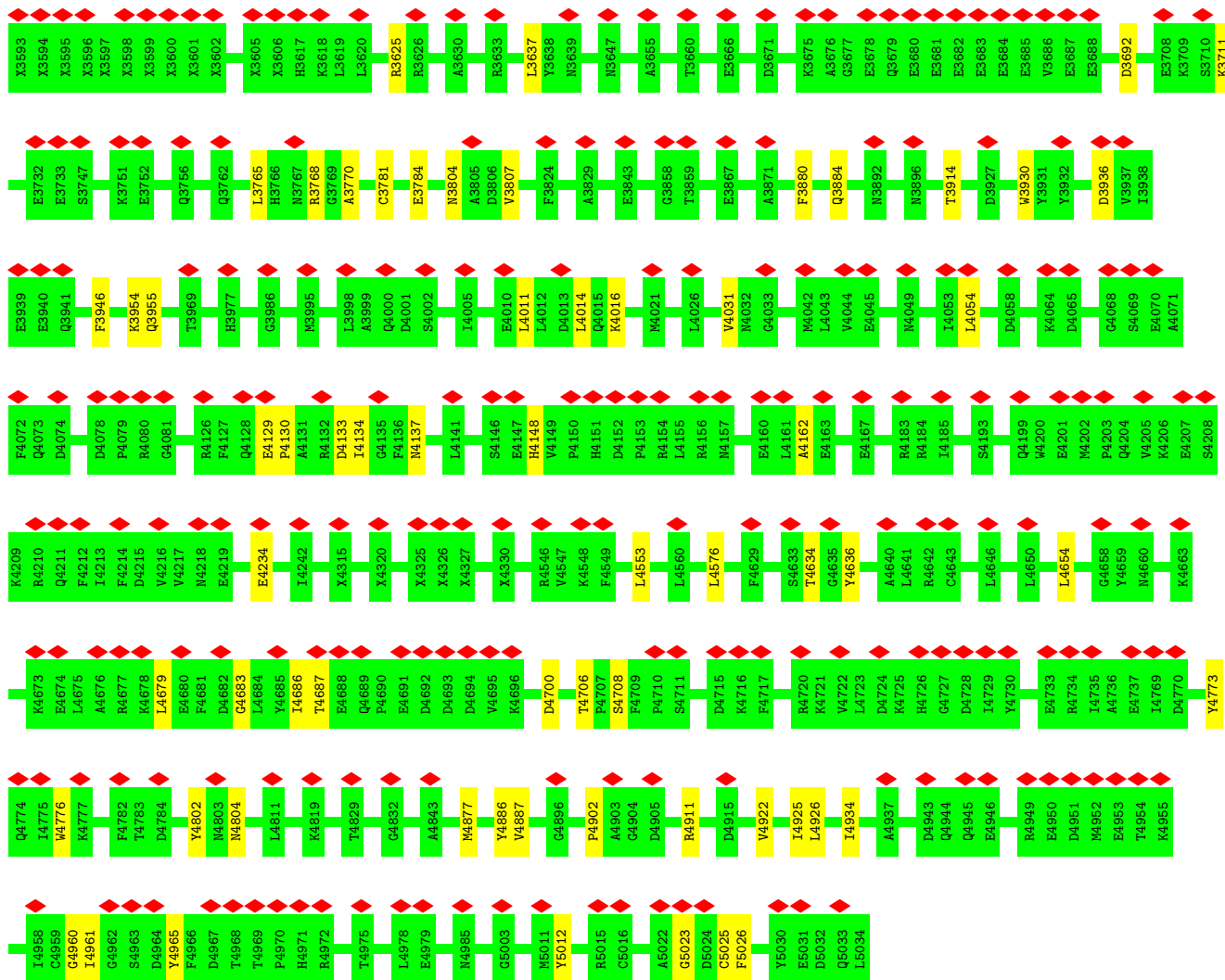

• Molecule 2: Ryanodine Receptor

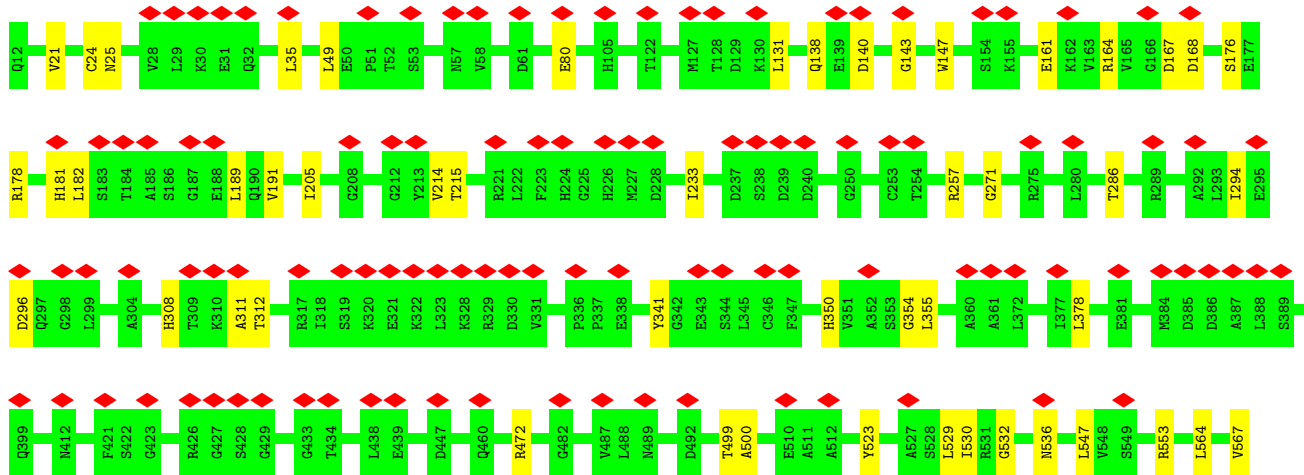

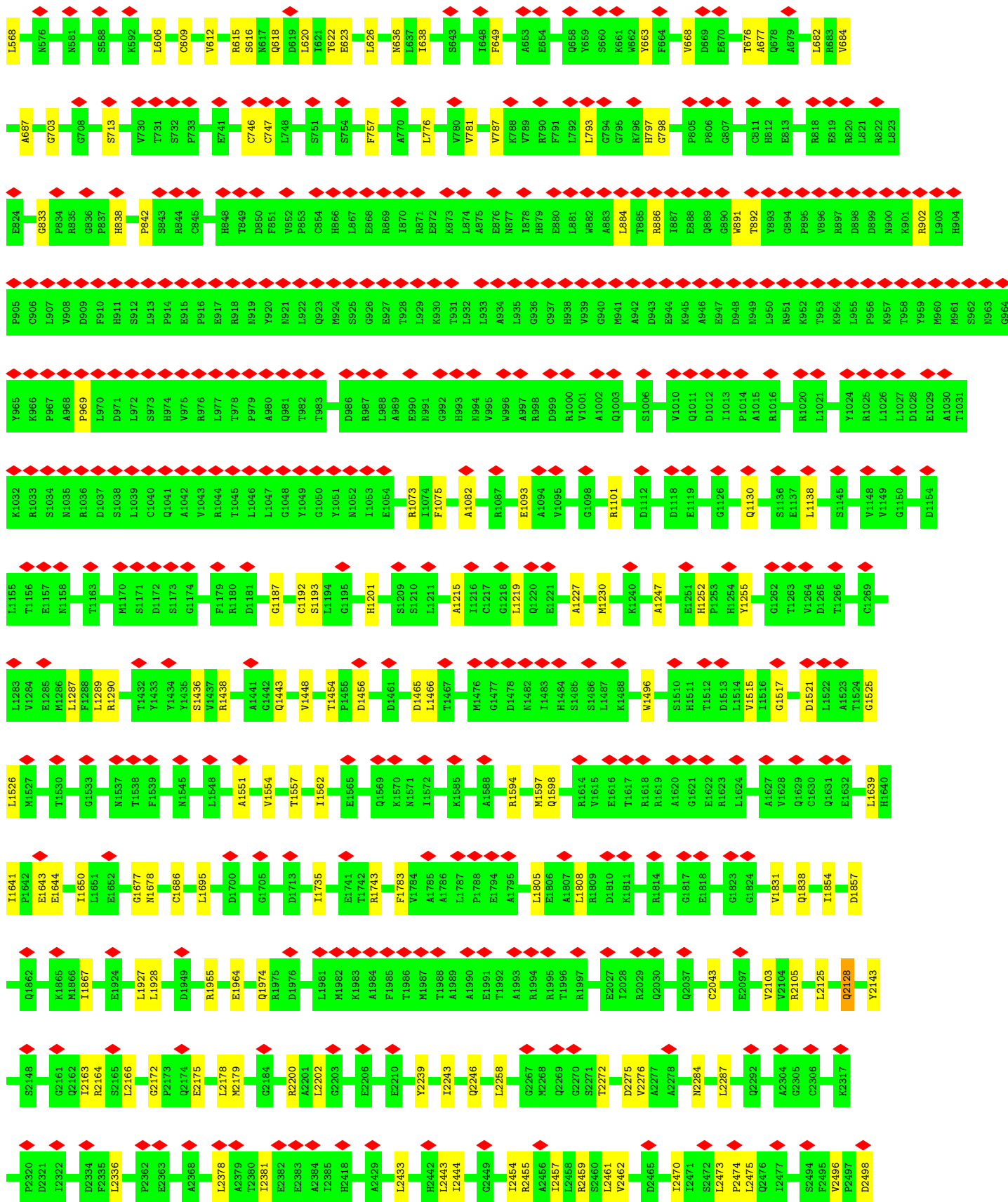

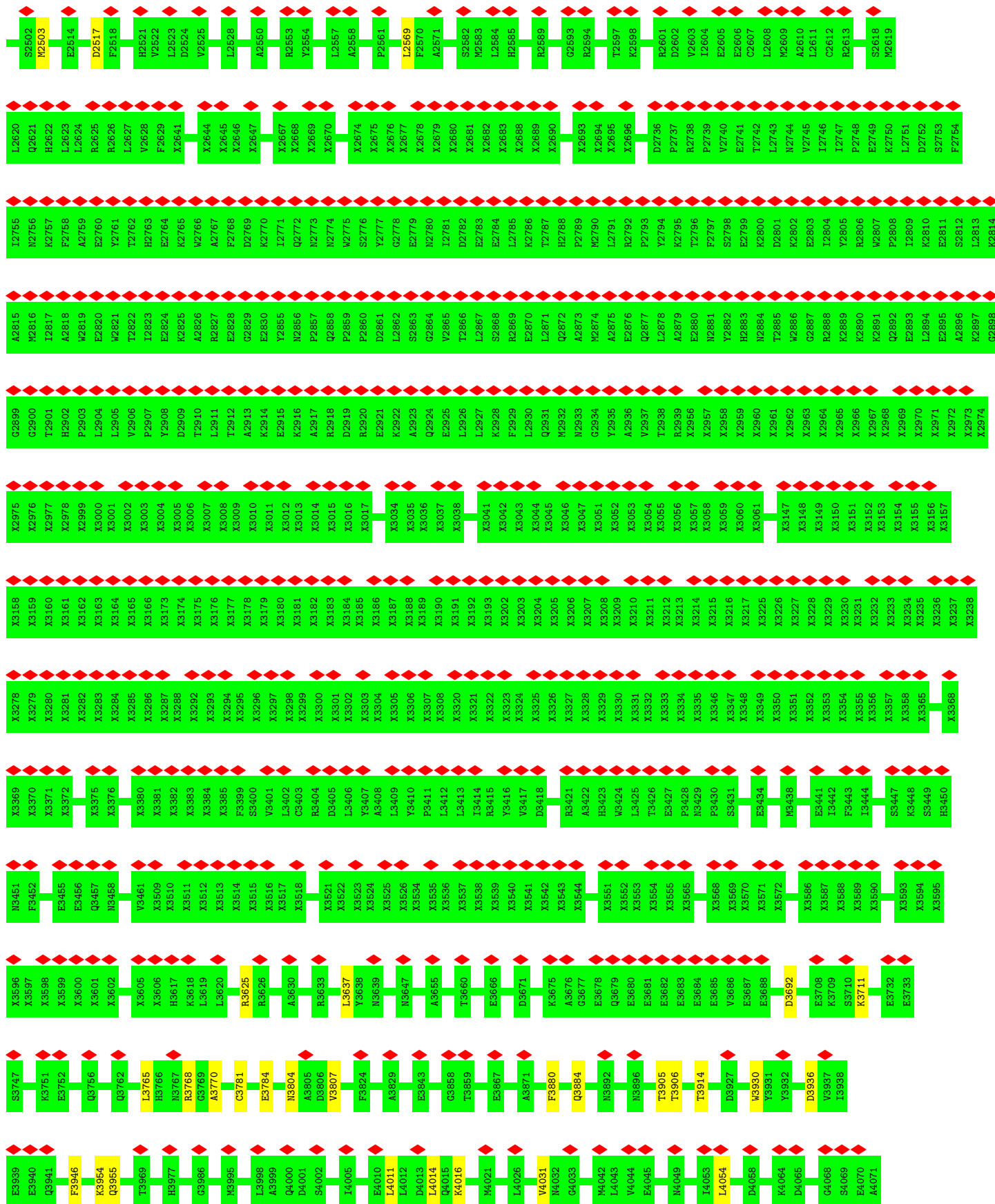

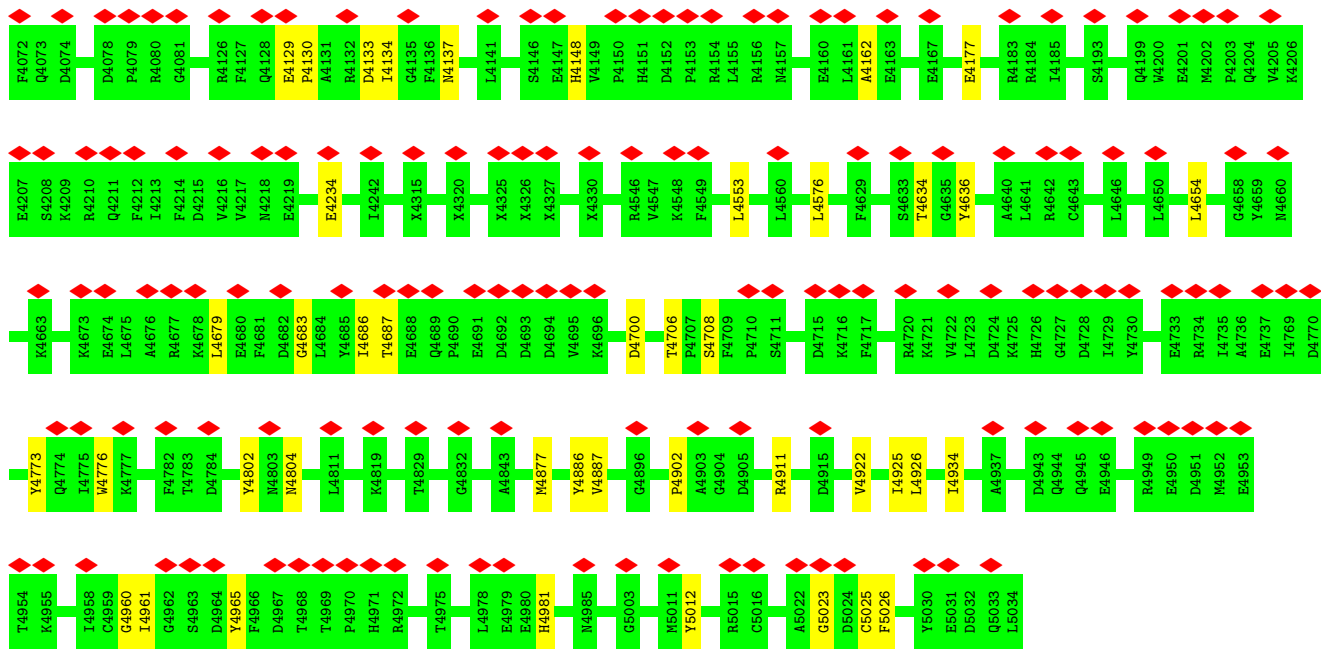

● Molecule 2: Ryanodine Receptor

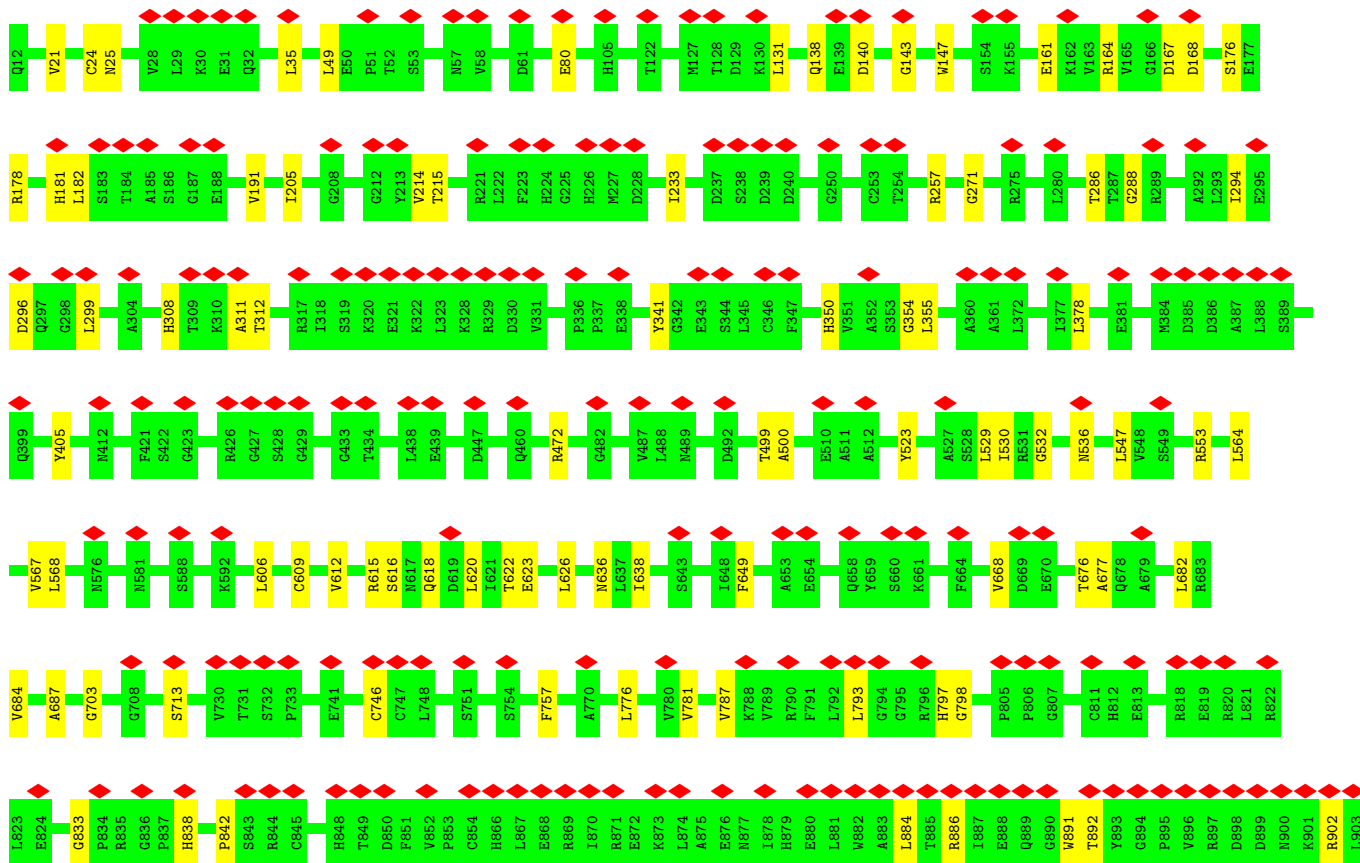

| | | | | | | | | | | | |
|-------|-------|-------|-------|-------|-------|-------|-------|-------|-------|-------|------|
| I2746 | L2608 | L2475 | L2287 | E2097 | G1824 | L1639 | A1523 | D1154 | T1091 | G964 | H904 |
| I2747 | M2609 | Q2476 | Q2292 | E2103 | V1831 | H1640 | T1524 | L1155 | K1032 | Y965 | P905 |
| P2748 | A2610 | I2477 | A2304 | V2104 | S1834 | P1642 | G1525 | T1156 | R1033 | K966 | C906 |
| E2749 | C2611 | S2494 | G2305 | R2106 | F1837 | E1643 | L1526 | E1157 | S1034 | P967 | L907 |
| K2750 | R2612 | V2496 | C2306 | L2125 | Q1838 | E1644 | M1527 | M1158 | N1035 | A968 | V908 |
| L2751 | R2613 | P2497 | K2317 | Q1828 | I1854 | I1650 | T1530 | T1163 | R1036 | P969 | D909 |
| S2752 | S2618 | D2498 | P2320 | Y2143 | D1857 | L1651 | R1290 | M1170 | D1037 | L970 | F910 |
| S2753 | L2620 | S2502 | D2321 | Q2148 | Q1862 | E1652 | G1533 | S1171 | S1038 | D971 | H911 |
| F2754 | Q2621 | M2503 | L2322 | S2148 | K1865 | M1677 | M1537 | D1172 | C1040 | S973 | S912 |
| N2755 | L2623 | E2514 | D2334 | G2161 | M1866 | N1678 | T1538 | D1173 | Q1041 | H974 | L913 |
| K2757 | R2625 | D2517 | L2336 | R2164 | I1867 | C1686 | F1539 | S1173 | Q1042 | V975 | P914 |
| F2758 | R2626 | F2518 | P2362 | S2165 | E1924 | L1695 | M1545 | G1174 | V1043 | R976 | E915 |
| A2759 | L2627 | H2521 | E2383 | L2166 | L1927 | L1696 | L1548 | F1179 | R1044 | L977 | P916 |
| E2760 | L2628 | V2522 | E2383 | Q2174 | L1928 | L1735 | L1548 | R1180 | T1045 | T978 | R918 |
| E2761 | F2629 | D2524 | A2368 | E2175 | E1949 | E1741 | A1551 | D1181 | L1046 | P979 | N919 |
| H2763 | F2629 | D2524 | L2368 | L2178 | L1928 | T1742 | V1554 | G1187 | L1047 | A980 | Y920 |
| E2764 | X2641 | V2525 | A2368 | M2179 | R1955 | R1743 | V1554 | C1192 | G1048 | T982 | N921 |
| K2765 | X2644 | L2528 | L2378 | G2184 | E1964 | A1784 | A1565 | S1193 | Y1049 | T983 | Q923 |
| W2766 | X2645 | A2550 | A2379 | R2200 | Q1975 | I1745 | Q1569 | L1194 | G1050 | D986 | M924 |
| A2767 | X2646 | A2550 | T2380 | A2201 | R1975 | I1745 | K1570 | L1194 | N1052 | S925 | S925 |
| F2768 | X2647 | R2553 | E2381 | L2178 | Q1975 | I1745 | M1571 | G1195 | I1053 | R987 | G926 |
| D2769 | X2667 | Y2554 | E2382 | M2179 | D1976 | H1777 | I1572 | H1201 | E1054 | A989 | E927 |
| K2770 | X2668 | L2557 | E2383 | G2184 | D1976 | F1783 | I1572 | S1209 | R1073 | E990 | T928 |
| I2771 | X2668 | A2558 | E2383 | R2200 | D1976 | A1784 | L1466 | S1210 | F1075 | M991 | L929 |
| Q2772 | X2669 | L2558 | A2384 | A2201 | D1976 | I1745 | L1466 | L1211 | F1075 | G992 | K930 |
| N2773 | X2670 | L2558 | H2418 | L2202 | L1981 | H1777 | T1467 | A1215 | A1082 | H993 | T931 |
| W2774 | X2674 | P2561 | A2429 | G2203 | M1982 | F1783 | M1476 | C1217 | R1087 | N994 | L932 |
| N2775 | X2675 | L2569 | L2433 | E2206 | K1983 | A1785 | D1477 | G1218 | R1087 | V995 | L933 |
| S2776 | X2676 | F2570 | H2442 | E2210 | F1985 | A1786 | D1478 | L1219 | E1093 | W996 | A934 |
| Y2777 | X2677 | A2571 | L2444 | Y2239 | T1986 | P1788 | M1482 | Q1220 | A1094 | R998 | L935 |
| G2778 | X2678 | S2582 | L2444 | L2243 | M1987 | E1794 | T1483 | E1221 | V1095 | C937 | G936 |
| E2779 | X2679 | M2583 | Q2449 | Q2246 | T1988 | A1795 | S1465 | A1227 | G1098 | R1000 | H938 |
| N2780 | X2680 | L2584 | R2454 | Q2246 | A1989 | L1799 | S1466 | M1230 | V1001 | A1002 | G940 |
| I2781 | X2681 | H2585 | R2455 | G2267 | E1991 | L1805 | V1614 | K1240 | R1101 | Q1003 | M941 |
| D2782 | X2682 | R2589 | A2456 | M2266 | T1992 | E1806 | E1616 | A1247 | D1112 | S1006 | A942 |
| E2784 | X2683 | R2589 | L2457 | Q2269 | A1993 | A1807 | T1617 | A1247 | D1118 | V1010 | D943 |
| L2785 | X2688 | G2593 | L2458 | Q2270 | R1994 | L1808 | R1618 | E1251 | E1119 | Q1011 | E944 |
| K2786 | X2689 | R2594 | S2460 | G2271 | R1995 | R1809 | R1619 | H1252 | D1012 | D1012 | A946 |
| T2787 | X2693 | R2594 | L2461 | T2272 | T1996 | D1810 | A1620 | P1253 | I1013 | I1013 | E947 |
| H2788 | X2694 | T2597 | V2462 | D2275 | K1811 | K1811 | G1621 | Y1255 | H1254 | P1014 | D948 |
| P2789 | X2695 | K2598 | D2465 | A2278 | R1814 | R1814 | R1623 | G1262 | P1015 | A1015 | N949 |
| M2790 | D2736 | R2601 | I2470 | A2278 | G1817 | G1817 | L1624 | T1263 | R1016 | R1016 | L950 |
| L2791 | P2737 | D2602 | L2471 | M2284 | E1818 | E1818 | A1627 | V1264 | R1020 | R1020 | K951 |
| R2792 | R2738 | V2603 | L2472 | | | | Q1628 | D1265 | L1021 | L1021 | T953 |
| P2793 | P2739 | E2604 | L2473 | | | | C1630 | T1266 | | | K954 |
| Y2794 | P2739 | E2606 | P2474 | | | | Q1631 | | | | L955 |
| T2795 | P2739 | E2606 | | | | | | | | | P956 |
| F2797 | V2740 | E2741 | | | | | | | | | K957 |
| S2798 | E2741 | T2742 | | | | | | | | | T958 |
| K2800 | L2743 | L2743 | | | | | | | | | Y959 |
| D2801 | N2744 | N2745 | | | | | | | | | M960 |
| K2802 | E2803 | | | | | | | | | | S962 |
| I2804 | | | | | | | | | | | N963 |

| | | | | | | | | | | | | | | | | | | | | | | | | | | | | | | | | | | | | | | | | | | | | | | | | | | | | | | | | | | | | | |
|-------|-------|-------|-------|-------|-------|-------|-------|-------|-------|-------|-------|-------|-------|-------|-------|-------|-------|-------|-------|-------|-------|-------|-------|-------|-------|-------|-------|-------|-------|-------|-------|-------|-------|-------|-------|-------|-------|-------|-------|-------|-------|-------|-------|-------|-------|-------|-------|-------|-------|-------|-------|-------|-------|-------|-------|-------|-------|-------|-------|-------|-------|
| L4646 | L4650 | L4654 | G4658 | Y4659 | M4660 | K4663 | K4673 | E4674 | L4675 | A4676 | R4677 | L4678 | L4679 | E4680 | F4681 | D4682 | C4683 | L4684 | Y4685 | L4686 | D4687 | E4688 | Q4689 | P4690 | E4691 | D4692 | D4693 | D4694 | V4695 | K4696 | D4700 | T4706 | F4707 | S4708 | F4709 | P4710 | S4711 | D4715 | K4716 | F4717 | R4720 | S4633 | T4634 | Y4636 | A4640 | L4641 | R4642 | C4643 | D4728 | | | | | | | | | | | | |
| D4058 | K4064 | D4065 | G4068 | S4069 | E4070 | A4071 | F4072 | Q4073 | D4074 | D4078 | P4079 | R4080 | G4081 | R4126 | F4127 | Q4128 | P4129 | A4130 | A4131 | R4132 | D4133 | A3999 | Q4000 | D4001 | S4002 | I4005 | E4010 | L4011 | L4012 | D4013 | L4014 | D4015 | K4016 | M4021 | L4026 | M4031 | G4033 | M4042 | L4043 | V4044 | E4045 | M4049 | L4053 | L4054 | R4183 | R4184 | L4185 | | | | | | | | | | | | | | |
| S4193 | Q4199 | W4200 | M4201 | M4202 | P4203 | Q4204 | V4205 | K4206 | E4207 | S4208 | K4209 | R4210 | Q4211 | F4212 | L4213 | F4214 | D4215 | V4216 | W4217 | M4218 | E4219 | E4234 | L4242 | X4315 | X4320 | X4325 | X4326 | X4327 | X4330 | R4546 | V4547 | K4548 | F4549 | L4553 | L4560 | L4576 | F4629 | S4633 | T4634 | Y4636 | A4640 | L4641 | R4642 | C4643 | | | | | | | | | | | | | | | | | |
| D4058 | K4064 | D4065 | G4068 | S4069 | E4070 | A4071 | F4072 | Q4073 | D4074 | D4078 | P4079 | R4080 | G4081 | R4126 | F4127 | Q4128 | P4129 | A4130 | A4131 | R4132 | D4133 | A3999 | Q4000 | D4001 | S4002 | I4005 | E4010 | L4011 | L4012 | D4013 | L4014 | D4015 | K4016 | M4021 | L4026 | M4031 | G4033 | M4042 | L4043 | V4044 | E4045 | M4049 | L4053 | L4054 | R4183 | R4184 | L4185 | | | | | | | | | | | | | | |
| E3687 | E3688 | D3692 | K3708 | K3709 | S3710 | K3711 | E3732 | E3733 | S3747 | K3751 | E3752 | Q3756 | Q3762 | L3765 | H3766 | N3767 | K3768 | G3769 | A3770 | Q3623 | R3624 | R3625 | R3626 | A3630 | R3633 | L3637 | T3638 | M3639 | M3647 | A3655 | G3858 | T3859 | E3867 | A3871 | F3880 | Q3884 | G3677 | E3678 | Q3679 | E3680 | E3681 | E3682 | E3683 | E3684 | E3685 | V3686 | | | | | | | | | | | | | | | |
| E3441 | I3442 | F3443 | I3444 | S3447 | K3448 | S3449 | H3450 | N3451 | F3452 | E3455 | E3456 | Q3457 | N3458 | V3461 | X3509 | X3510 | X3511 | X3512 | X3513 | X3514 | X3515 | X3516 | X3517 | X3518 | X3521 | X3522 | X3523 | X3524 | X3525 | X3526 | X3534 | X3535 | X3536 | X3537 | X3538 | X3539 | X3551 | X3552 | X3553 | X3554 | X3555 | X3556 | N3429 | P3430 | S3431 | X3570 | X3571 | X3572 | H3438 | | | | | | | | | | | | |
| X3566 | X3567 | X3568 | X3569 | X3593 | X3594 | X3595 | X3596 | X3597 | X3598 | X3599 | X3600 | X3601 | X3602 | X3605 | X3606 | H3617 | K3618 | L3619 | L3620 | S3621 | K3622 | R3623 | R3624 | R3625 | R3626 | A3630 | R3633 | L3637 | T3638 | M3639 | M3647 | A3655 | G3858 | T3859 | E3867 | A3871 | F3880 | Q3884 | G3677 | E3678 | Q3679 | E3680 | E3681 | E3682 | E3683 | E3684 | E3685 | V3686 | | | | | | | | | | | | | |
| E3441 | I3442 | F3443 | I3444 | S3447 | K3448 | S3449 | H3450 | N3451 | F3452 | E3455 | E3456 | Q3457 | N3458 | V3461 | X3509 | X3510 | X3511 | X3512 | X3513 | X3514 | X3515 | X3516 | X3517 | X3518 | X3521 | X3522 | X3523 | X3524 | X3525 | X3526 | X3534 | X3535 | X3536 | X3537 | X3538 | X3539 | X3551 | X3552 | X3553 | X3554 | X3555 | X3556 | N3429 | P3430 | S3431 | X3570 | X3571 | X3572 | H3438 | | | | | | | | | | | | |
| X3353 | X3354 | X3355 | X3356 | X3357 | X3358 | X3359 | X3368 | X3369 | X3370 | X3371 | X3372 | X3375 | X3376 | X3380 | X3381 | X3382 | X3383 | X3384 | X3385 | F3389 | S3400 | V3401 | L3402 | X3403 | X3404 | D3405 | L3406 | X3407 | A3408 | X3410 | F3411 | L3412 | L3413 | L3414 | R3415 | V3417 | D3418 | R3421 | A3422 | H3423 | W3424 | L3425 | T3426 | E3427 | P3428 | N3429 | P3430 | S3431 | X3566 | X3567 | X3568 | X3569 | X3570 | X3571 | X3572 | H3438 | | | | | |
| X3230 | X3231 | X3232 | X3233 | X3234 | X3235 | X3236 | X3237 | X3238 | X3278 | X3279 | X3280 | X3281 | X3282 | X3283 | X3284 | X3285 | X3286 | X3287 | X3288 | X3292 | X3293 | X3294 | X3295 | X3296 | X3297 | X3298 | X3299 | X3300 | X3301 | X3302 | X3303 | X3304 | X3305 | X3306 | X3307 | X3308 | X3320 | X3321 | X3322 | X3323 | X3324 | X3325 | X3326 | X3327 | X3328 | X3329 | X3330 | X3331 | X3332 | X3333 | X3334 | X3335 | X3336 | X3346 | X3347 | X3348 | X3349 | X3350 | X3351 | X3352 | X3353 |
| X3149 | X3150 | X3151 | X3152 | X3153 | X3154 | X3155 | X3156 | X3157 | X3158 | X3159 | X3160 | X3161 | X3162 | X3163 | X3164 | X3165 | X3166 | X3173 | X3174 | X3175 | X3176 | X3177 | X3178 | X3179 | X3180 | X3181 | X3182 | X3183 | X3184 | X3185 | X3186 | X3187 | X3188 | X3189 | X3190 | X3191 | X3192 | X3193 | X3203 | X3204 | X3205 | X3206 | X3207 | X3208 | X3209 | X3210 | X3211 | X3212 | X3213 | X3214 | X3215 | X3216 | X3217 | X3225 | X3226 | X3227 | X3228 | X3229 | | | |
| X2966 | X2967 | X2968 | X2969 | X2970 | X2971 | X2972 | X2973 | X2974 | X2975 | X2976 | X2977 | X2978 | X2979 | X2980 | X3000 | X3001 | X3002 | X3003 | X3004 | X3005 | X3006 | X3007 | X3008 | X3009 | X3010 | X3011 | X3012 | X3013 | X3014 | X3015 | X3016 | X3017 | X3034 | X3035 | X3036 | X3037 | X3038 | X3041 | X3042 | X3043 | X3044 | X3045 | X3046 | X3047 | X3051 | X3052 | X3053 | X3054 | X3055 | X3056 | X3057 | X3058 | X3059 | X3060 | X3061 | X3147 | X3148 | | | | |
| K2890 | K2891 | Q2892 | E2893 | L2894 | E2895 | A2896 | K2897 | G2898 | G2899 | G2900 | T2901 | H2902 | P2903 | P2904 | L2905 | V2906 | P2907 | Y2908 | D2909 | T2910 | L2911 | T2912 | A2913 | K2914 | E2915 | K2916 | A2917 | Q2918 | D2919 | R2920 | E2921 | K2922 | A2923 | Q2924 | E2925 | L2926 | L2927 | K2928 | F2929 | L2930 | Q2931 | M2932 | N2933 | G2934 | Y2935 | A2936 | V2937 | T2938 | R2939 | X2956 | X2957 | X2958 | X2959 | X2960 | X2961 | X2962 | X2963 | X2964 | X2965 | | |
| R2806 | W2807 | P2808 | L2809 | K2810 | E2811 | S2812 | L2813 | K2814 | A2815 | M2816 | L2817 | A2818 | W2819 | E2820 | W2821 | T2822 | L2823 | E2824 | K2825 | A2826 | L2827 | E2828 | Q2829 | E2830 | Y2835 | M2856 | P2857 | Q2858 | R2859 | P2860 | D2861 | L2862 | S2863 | G2864 | V2865 | L2866 | L2867 | S2868 | R2869 | E2870 | L2871 | Q2872 | A2873 | A2874 | E2875 | E2876 | Q2877 | L2878 | A2879 | E2880 | N2881 | Y2882 | H2883 | M2884 | T2885 | W2886 | Q2887 | R2888 | | | |

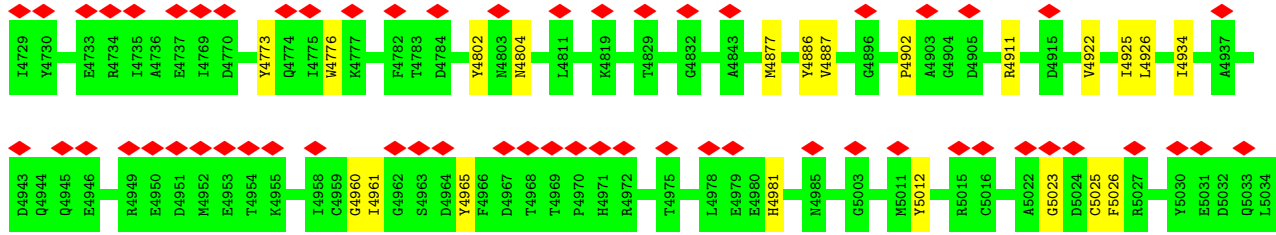

• Molecule 2: Ryanodine Receptor

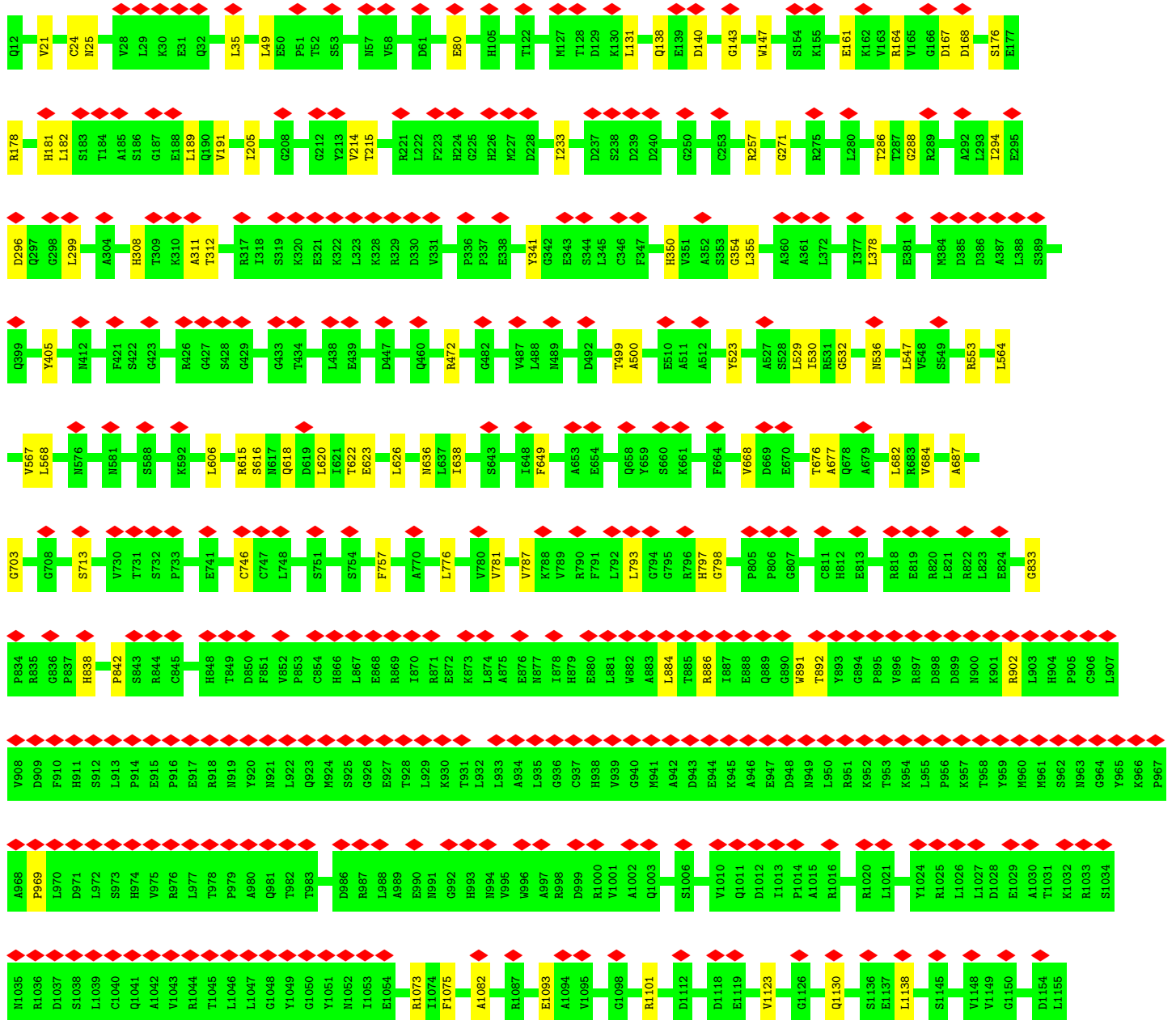
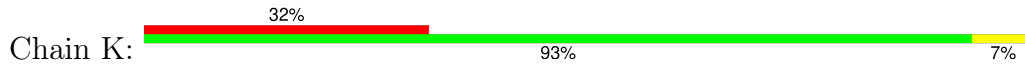

| | | | | | | | | | | | | | | | | | | | | | | | | | | | | | | | | | | | | | | | | | | | | | | | | | | | | | | | | | | | |
|-------|-------|-------|-------|-------|-------|-------|-------|-------|-------|-------|-------|-------|-------|-------|-------|-------|-------|-------|-------|-------|-------|-------|-------|-------|-------|-------|-------|-------|-------|-------|-------|-------|-------|-------|-------|-------|-------|-------|-------|-------|-------|-------|-------|-------|-------|-------|-------|-------|-------|-------|-------|-------|-------|-------|-------|-------|-------|-------|-------|
| T1156 | E1157 | M1158 | T1163 | M1170 | S1171 | D1172 | S1173 | G1174 | F1179 | R1180 | D1181 | G1187 | C1192 | S1193 | L1194 | G1195 | H1201 | S1209 | S1210 | L1211 | A1215 | L1216 | C1217 | G1218 | L1219 | Q1220 | E1221 | A1227 | M1230 | K1240 | A1247 | E1251 | H1252 | P1253 | H1254 | Y1255 | G1262 | T1263 | V1264 | D1265 | T1266 | G1269 | L1283 | | | | | | | | | | | | | | | | |
| V1284 | E1285 | M1286 | L1287 | F1288 | L1289 | R1290 | T1432 | Y1433 | Y1434 | Y1435 | S1436 | F1437 | R1438 | A1441 | G1442 | Q1443 | V1448 | T1454 | F1455 | P1456 | D1461 | D1465 | S1466 | T1467 | M1476 | G1477 | D1478 | L1482 | I1483 | H1484 | S1485 | S1486 | L1487 | K1488 | W1496 | S1510 | H1511 | T1512 | D1513 | L1514 | V1515 | H1516 | G1517 | D1521 | L1522 | A1523 | T1524 | G1525 | L1526 | | | | | | | | | | |
| M1527 | T1530 | G1533 | M1537 | T1538 | F1539 | M1545 | L1548 | A1551 | V1554 | T1557 | I1562 | E1565 | Q1569 | K1570 | M1571 | I1572 | K1585 | A1588 | R1594 | M1597 | Q1598 | M1599 | L1600 | R1614 | V1615 | E1616 | T1617 | R1618 | R1619 | A1620 | G1621 | E1622 | M1623 | L1624 | A1627 | V1628 | Q1629 | Q1630 | Q1631 | E1632 | A1638 | | | | | | | | | | | | | | | | | | |
| L1639 | H1640 | I1641 | P1642 | E1643 | E1644 | I1650 | L1651 | E1652 | G1677 | M1678 | C1686 | L1695 | D1700 | G1705 | D1713 | I1735 | E1741 | T1742 | R1743 | A1744 | I1745 | F1783 | V1784 | A1785 | A1786 | L1787 | P1788 | E1794 | A1795 | L1805 | E1806 | A1807 | L1808 | R1809 | D1810 | K1811 | R1814 | G1817 | E1818 | G1823 | G1824 | V1831 | Q1838 | | | | | | | | | | | | | | | | |
| I1854 | D1857 | Q1862 | K1865 | M1866 | I1867 | E1924 | L1927 | L1928 | D1949 | R1955 | E1964 | Q1974 | R1975 | D1976 | L1981 | M1982 | K1983 | A1984 | F1985 | T1986 | M1987 | T1988 | A1989 | A1990 | E1991 | T1992 | A1993 | R1994 | R1995 | T1996 | R1997 | E2027 | I2028 | R2029 | Q2030 | Q2037 | C2043 | E2097 | V2103 | V2104 | R2105 | L2125 | | | | | | | | | | | | | | | | | |
| Q2128 | Y2143 | S2148 | Q2161 | Q2162 | I2163 | R2164 | S2165 | L2166 | G2172 | P2173 | Q2174 | E2175 | L2178 | M2179 | R2200 | A2201 | L2202 | G2203 | E2206 | E2210 | Y2239 | L2243 | I2444 | Q2246 | L2258 | G2267 | M2268 | Q2269 | Q2270 | S2271 | T2272 | D2275 | V2276 | A2277 | A2278 | N2284 | L2287 | Q2292 | A2304 | | | | | | | | | | | | | | | | | | | | |
| Q2305 | C2306 | K2317 | P2320 | D2321 | I2322 | D2334 | F2336 | L2336 | P2362 | E2363 | A2368 | L2378 | A2379 | T2380 | I2381 | E2382 | E2383 | A2384 | I2385 | H2418 | A2429 | L2433 | H2442 | L2443 | I2444 | G2449 | T2454 | R2455 | A2456 | I2457 | L2458 | R2459 | S2460 | L2461 | V2462 | D2465 | I2470 | I2471 | S2472 | L2473 | P2474 | L2475 | Q2476 | I2477 | S2494 | | | | | | | | | | | | | | |
| F2495 | V2496 | P2497 | D2498 | S2502 | M2503 | E2514 | D2517 | F2518 | H2521 | V2522 | L2523 | D2524 | V2525 | L2528 | A2550 | R2553 | Y2554 | L2557 | A2558 | P2561 | L2569 | F2570 | A2571 | S2582 | M2583 | L2584 | H2585 | R2589 | G2593 | R2594 | T2597 | K2598 | R2601 | D2602 | V2603 | L2604 | E2605 | P2607 | Q2607 | L2608 | M2609 | A2610 | L2611 | C2612 | | | | | | | | | | | | | | | |
| R2613 | S2618 | M2619 | L2620 | Q2621 | H2622 | L2623 | L2624 | R2625 | R2626 | L2627 | V2628 | F2629 | X2641 | X2644 | X2645 | X2646 | X2647 | X2667 | X2668 | X2669 | X2670 | X2674 | X2675 | X2677 | X2678 | X2679 | X2680 | X2681 | X2682 | X2683 | X2688 | X2689 | X2690 | X2693 | X2694 | X2695 | X2696 | D2736 | F2737 | R2738 | F2739 | V2740 | E2741 | T2742 | L2743 | N2744 | V2745 | I2746 | I2747 | P2748 | E2749 | K2750 | | | | | | | |
| L2751 | D2752 | S2753 | F2754 | I2755 | N2756 | K2757 | F2758 | A2759 | E2760 | Y2761 | T2762 | H2763 | E2764 | K2765 | W2766 | A2767 | F2768 | D2769 | K2770 | I2771 | Q2772 | M2773 | N2774 | W2775 | S2776 | Y2777 | G2778 | E2779 | M2780 | L2781 | D2782 | E2783 | L2785 | K2786 | T2787 | H2788 | F2789 | M2790 | L2791 | R2792 | F2793 | Y2794 | T2795 | K2796 | F2797 | S2798 | E2799 | K2800 | D2801 | K2802 | E2803 | I2804 | Y2805 | R2806 | W2807 | P2808 | I2809 | K2810 | |
| E2811 | S2812 | L2813 | K2814 | A2815 | M2816 | L2817 | A2818 | M2819 | E2820 | M2821 | T2822 | L2823 | E2824 | K2825 | A2826 | R2827 | E2828 | G2829 | E2830 | Y2855 | X2856 | P2857 | Q2858 | P2859 | R2860 | D2861 | L2862 | S2863 | G2864 | V2865 | T2866 | L2867 | R2868 | R2869 | E2870 | L2871 | D2872 | H2873 | M2874 | A2875 | A2876 | Q2877 | L2878 | A2879 | R2880 | M2881 | Y2882 | H2883 | M2884 | T2885 | W2886 | G2887 | R2888 | K2889 | K2890 | L2891 | Q2892 | E2893 | L2894 |
| E2895 | A2896 | K2897 | G2898 | G2899 | G2900 | T2901 | H2902 | P2903 | L2904 | L2905 | V2906 | P2907 | Y2908 | D2909 | T2910 | L2911 | T2912 | A2913 | K2914 | E2915 | K2916 | A2917 | R2918 | D2919 | R2920 | E2921 | K2922 | A2923 | Q2924 | E2925 | L2926 | L2927 | K2928 | F2929 | L2930 | Q2931 | M2932 | N2933 | G2934 | Y2935 | A2936 | V2937 | T2938 | R2939 | X2956 | X2957 | X2958 | X2959 | X2960 | X2961 | X2962 | X2963 | X2964 | X2965 | X2966 | X2967 | X2968 | X2969 | X2970 |
| X2971 | X2972 | X2973 | X2974 | X2975 | X2976 | X2977 | X2978 | X2979 | X3000 | X3001 | X3002 | X3003 | X3004 | X3005 | X3006 | X3007 | X3008 | X3009 | X3010 | X3011 | X3012 | X3013 | X3014 | X3015 | X3016 | X3017 | X3034 | X3035 | X3036 | X3037 | X3038 | X3041 | X3042 | X3043 | X3044 | X3045 | X3046 | X3047 | X3051 | X3052 | X3053 | X3054 | X3055 | X3057 | X3058 | X3059 | X3060 | X3061 | X3147 | X3148 | X3149 | X3150 | X3151 | X3152 | X3153 | | | | |

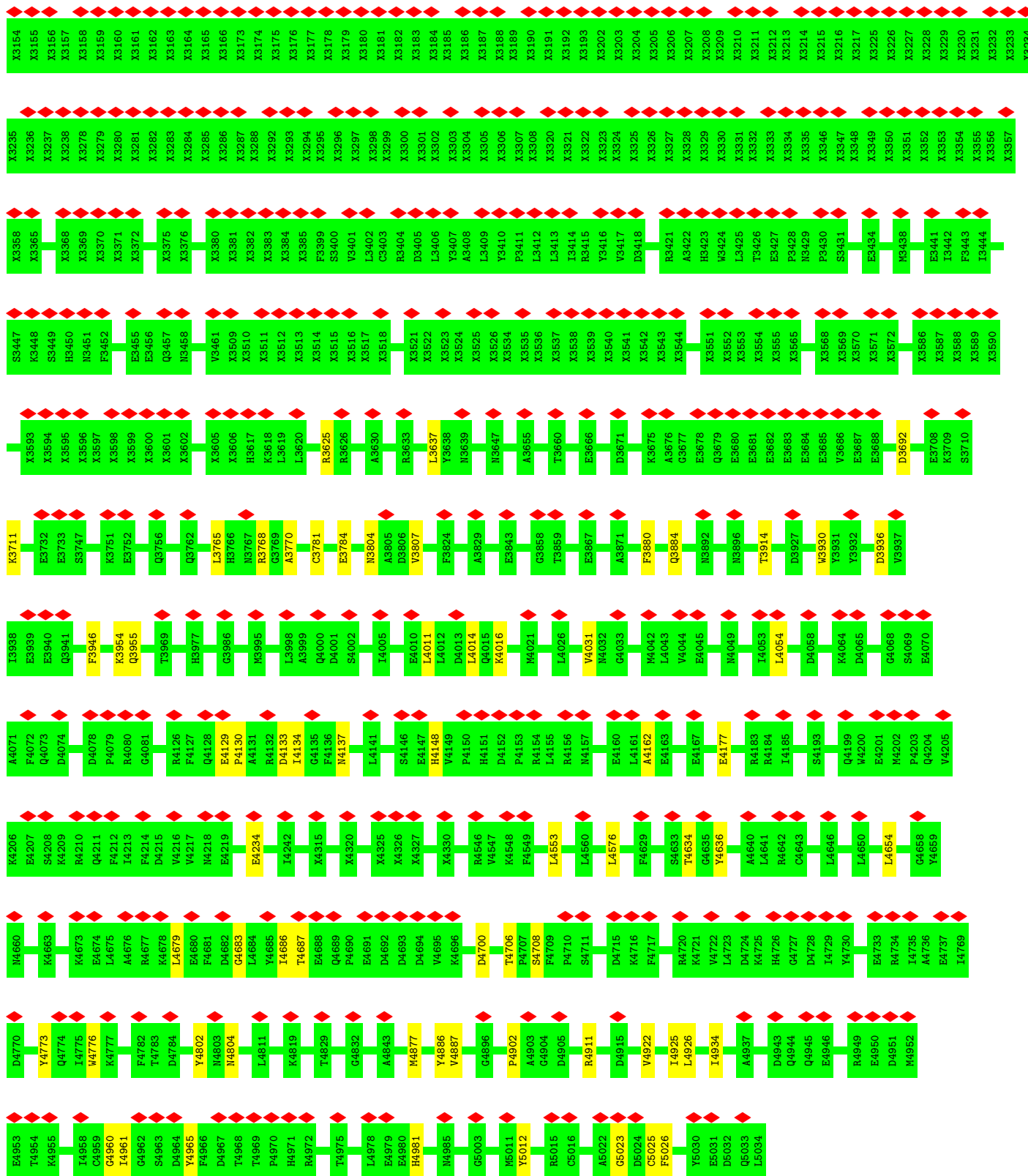

• Molecule 3: Calmodulin-1

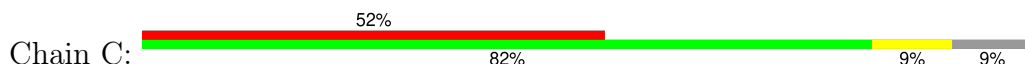

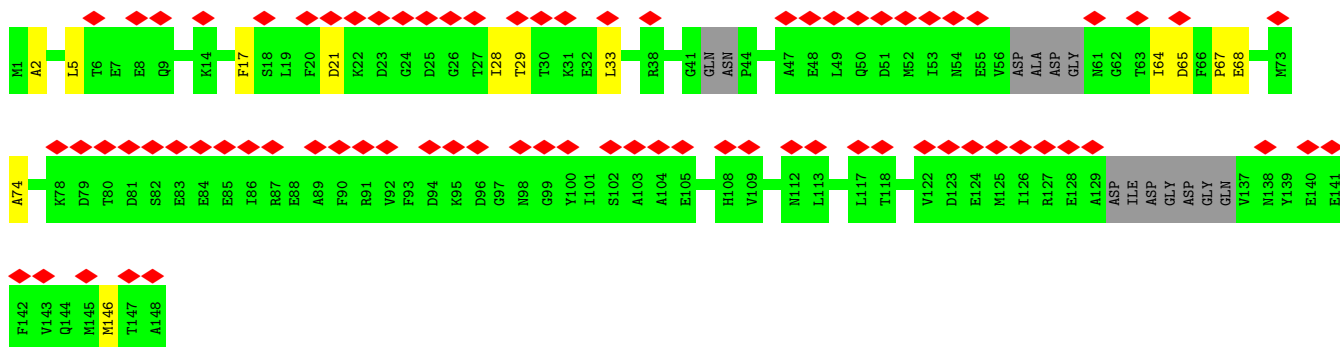

• Molecule 3: Calmodulin-1

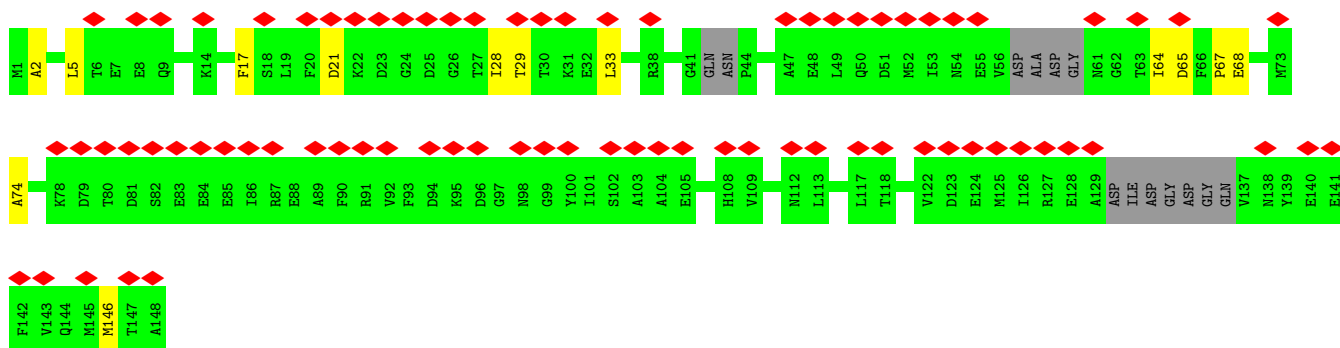
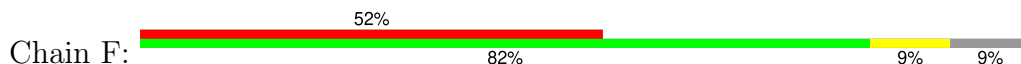

• Molecule 3: Calmodulin-1

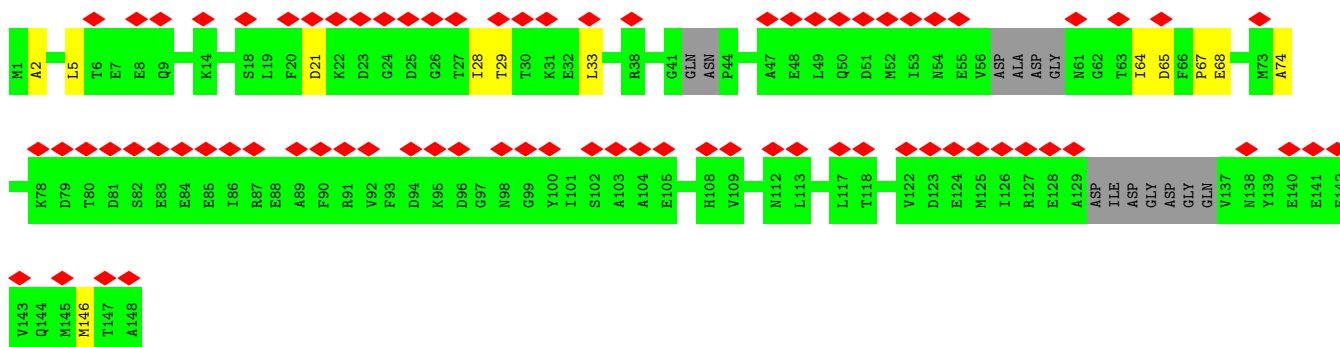
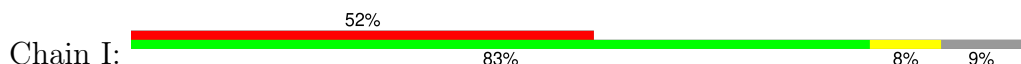

• Molecule 3: Calmodulin-1

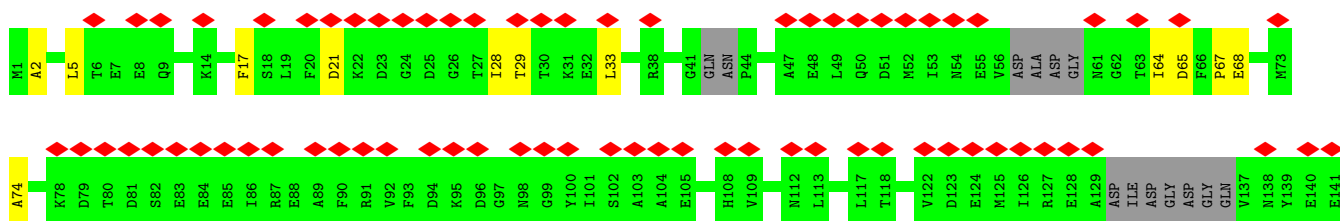
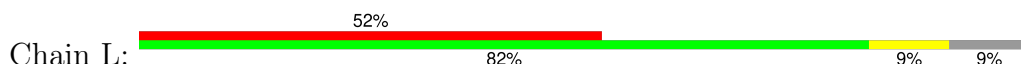

| | | | | | | |
|------|------|------|------|------|------|------|
| F142 | V143 | Q144 | M145 | M146 | T147 | A148 |
|------|------|------|------|------|------|------|

4 Experimental information

| Property | Value | Source |
|--------------------------------------|--------------------------|-----------|
| EM reconstruction method | SINGLE PARTICLE | Depositor |
| Imposed symmetry | POINT, Not provided | |
| Number of particles used | 25122 | Depositor |
| Resolution determination method | FSC 0.143 CUT-OFF | Depositor |
| CTF correction method | NONE | Depositor |
| Microscope | FEI TITAN KRIOS | Depositor |
| Voltage (kV) | 300 | Depositor |
| Electron dose ($e^-/\text{\AA}^2$) | 50 | Depositor |
| Minimum defocus (nm) | Not provided | |
| Maximum defocus (nm) | Not provided | |
| Magnification | Not provided | |
| Image detector | FEI FALCON III (4k x 4k) | Depositor |
| Maximum map value | 0.173 | Depositor |
| Minimum map value | -0.136 | Depositor |
| Average map value | -0.000 | Depositor |
| Map value standard deviation | 0.004 | Depositor |
| Recommended contour level | 0.022 | Depositor |
| Map size (\AA) | 523.2, 523.2, 523.2 | wwPDB |
| Map dimensions | 480, 480, 480 | wwPDB |
| Map angles ($^\circ$) | 90.0, 90.0, 90.0 | wwPDB |
| Pixel spacing (\AA) | 1.09, 1.09, 1.09 | Depositor |

5 Model quality [i](#)

5.1 Standard geometry [i](#)

Bond lengths and bond angles in the following residue types are not validated in this section:
ZN

The Z score for a bond length (or angle) is the number of standard deviations the observed value is removed from the expected value. A bond length (or angle) with $|Z| > 5$ is considered an outlier worth inspection. RMSZ is the root-mean-square of all Z scores of the bond lengths (or angles).

| Mol | Chain | Bond lengths | | Bond angles | |
|-----|-------|--------------|----------|-------------|----------|
| | | RMSZ | # Z >5 | RMSZ | # Z >5 |
| 1 | A | 0.25 | 0/743 | 0.42 | 0/1014 |
| 1 | D | 0.25 | 0/743 | 0.42 | 0/1014 |
| 1 | G | 0.25 | 0/743 | 0.42 | 0/1014 |
| 1 | J | 0.25 | 0/743 | 0.42 | 0/1014 |
| 2 | B | 0.23 | 0/25353 | 0.38 | 0/34606 |
| 2 | E | 0.23 | 0/25353 | 0.38 | 0/34606 |
| 2 | H | 0.23 | 0/25353 | 0.38 | 0/34606 |
| 2 | K | 0.23 | 0/25353 | 0.38 | 0/34606 |
| 3 | C | 0.24 | 0/772 | 0.36 | 0/1059 |
| 3 | F | 0.24 | 0/772 | 0.36 | 0/1059 |
| 3 | I | 0.24 | 0/772 | 0.36 | 0/1059 |
| 3 | L | 0.24 | 0/772 | 0.36 | 0/1059 |
| All | All | 0.23 | 0/107472 | 0.38 | 0/146716 |

There are no bond length outliers.

There are no bond angle outliers.

There are no chirality outliers.

There are no planarity outliers.

5.2 Too-close contacts [i](#)

In the following table, the Non-H and H(model) columns list the number of non-hydrogen atoms and hydrogen atoms in the chain respectively. The H(added) column lists the number of hydrogen atoms added and optimized by MolProbity. The Clashes column lists the number of clashes within the asymmetric unit, whereas Symm-Clashes lists symmetry-related clashes.

| Mol | Chain | Non-H | H(model) | H(added) | Clashes | Symm-Clashes |
|-----|-------|-------|----------|----------|---------|--------------|
| 1 | A | 727 | 0 | 651 | 8 | 0 |

Continued on next page...

Continued from previous page...

| Mol | Chain | Non-H | H(model) | H(added) | Clashes | Symm-Clashes |
|-----|-------|--------|----------|----------|---------|--------------|
| 1 | D | 727 | 0 | 651 | 8 | 0 |
| 1 | G | 727 | 0 | 651 | 8 | 0 |
| 1 | J | 727 | 0 | 651 | 8 | 0 |
| 2 | B | 26597 | 0 | 22867 | 156 | 0 |
| 2 | E | 26597 | 0 | 22867 | 153 | 0 |
| 2 | H | 26597 | 0 | 22867 | 157 | 0 |
| 2 | K | 26597 | 0 | 22867 | 157 | 0 |
| 3 | C | 768 | 0 | 486 | 9 | 0 |
| 3 | F | 768 | 0 | 486 | 9 | 0 |
| 3 | I | 768 | 0 | 486 | 8 | 0 |
| 3 | L | 768 | 0 | 486 | 9 | 0 |
| 4 | B | 1 | 0 | 0 | 0 | 0 |
| 4 | E | 1 | 0 | 0 | 0 | 0 |
| 4 | H | 1 | 0 | 0 | 0 | 0 |
| 4 | K | 1 | 0 | 0 | 0 | 0 |
| All | All | 112372 | 0 | 96016 | 654 | 0 |

The all-atom clashscore is defined as the number of clashes found per 1000 atoms (including hydrogen atoms). The all-atom clashscore for this structure is 3.

All (654) close contacts within the same asymmetric unit are listed below, sorted by their clash magnitude.

| Atom-1 | Atom-2 | Interatomic distance (Å) | Clash overlap (Å) |
|-------------------|------------------|--------------------------|-------------------|
| 2:E:886:ARG:HB2 | 2:E:891:TRP:HB2 | 1.73 | 0.71 |
| 2:B:886:ARG:HB2 | 2:B:891:TRP:HB2 | 1.73 | 0.71 |
| 2:H:886:ARG:HB2 | 2:H:891:TRP:HB2 | 1.73 | 0.71 |
| 2:K:886:ARG:HB2 | 2:K:891:TRP:HB2 | 1.73 | 0.71 |
| 2:E:4706:THR:HG21 | 2:E:4773:TYR:HB2 | 1.74 | 0.70 |
| 2:H:4706:THR:HG21 | 2:H:4773:TYR:HB2 | 1.74 | 0.69 |
| 2:K:1101:ARG:HB2 | 2:K:1193:SER:HB2 | 1.74 | 0.69 |
| 2:H:1101:ARG:HB2 | 2:H:1193:SER:HB2 | 1.74 | 0.69 |
| 2:K:4706:THR:HG21 | 2:K:4773:TYR:HB2 | 1.74 | 0.69 |
| 2:B:4706:THR:HG21 | 2:B:4773:TYR:HB2 | 1.74 | 0.69 |
| 2:B:1101:ARG:HB2 | 2:B:1193:SER:HB2 | 1.74 | 0.68 |
| 2:B:1082:ALA:HB1 | 2:B:1187:GLY:HA3 | 1.76 | 0.68 |
| 2:E:1082:ALA:HB1 | 2:E:1187:GLY:HA3 | 1.76 | 0.68 |
| 2:E:1101:ARG:HB2 | 2:E:1193:SER:HB2 | 1.74 | 0.67 |
| 2:H:1082:ALA:HB1 | 2:H:1187:GLY:HA3 | 1.76 | 0.67 |
| 2:K:1082:ALA:HB1 | 2:K:1187:GLY:HA3 | 1.76 | 0.66 |
| 2:E:3781:CYS:HB2 | 2:E:3784:GLU:HB3 | 1.78 | 0.66 |
| 2:B:3781:CYS:HB2 | 2:B:3784:GLU:HB3 | 1.78 | 0.65 |

Continued on next page...

Continued from previous page...

| Atom-1 | Atom-2 | Interatomic distance (Å) | Clash overlap (Å) |
|-------------------|-------------------|--------------------------|-------------------|
| 2:K:4960:GLY:HA3 | 2:K:5023:GLY:H | 1.61 | 0.65 |
| 2:K:3781:CYS:HB2 | 2:K:3784:GLU:HB3 | 1.78 | 0.65 |
| 2:E:4960:GLY:HA3 | 2:E:5023:GLY:H | 1.61 | 0.65 |
| 2:H:4960:GLY:HA3 | 2:H:5023:GLY:H | 1.61 | 0.65 |
| 2:B:4960:GLY:HA3 | 2:B:5023:GLY:H | 1.61 | 0.65 |
| 2:E:4902:PRO:HB3 | 2:E:4911:ARG:HG2 | 1.79 | 0.64 |
| 2:H:3781:CYS:HB2 | 2:H:3784:GLU:HB3 | 1.78 | 0.64 |
| 2:K:4902:PRO:HB3 | 2:K:4911:ARG:HG2 | 1.79 | 0.64 |
| 2:B:4902:PRO:HB3 | 2:B:4911:ARG:HG2 | 1.79 | 0.64 |
| 2:B:833:GLY:HA3 | 2:B:838:HIS:HD2 | 1.63 | 0.64 |
| 2:E:833:GLY:HA3 | 2:E:838:HIS:HD2 | 1.63 | 0.63 |
| 2:H:4902:PRO:HB3 | 2:H:4911:ARG:HG2 | 1.79 | 0.63 |
| 2:K:833:GLY:HA3 | 2:K:838:HIS:HD2 | 1.63 | 0.63 |
| 2:H:833:GLY:HA3 | 2:H:838:HIS:HD2 | 1.63 | 0.62 |
| 2:K:294:ILE:HG23 | 2:K:296:ASP:H | 1.67 | 0.60 |
| 2:B:294:ILE:HG23 | 2:B:296:ASP:H | 1.67 | 0.60 |
| 2:E:176:SER:HB2 | 2:E:178:ARG:HH21 | 1.67 | 0.60 |
| 2:E:2496:VAL:HG12 | 2:E:2498:ASP:H | 1.67 | 0.60 |
| 2:H:2496:VAL:HG12 | 2:H:2498:ASP:H | 1.67 | 0.60 |
| 2:E:294:ILE:HG23 | 2:E:296:ASP:H | 1.67 | 0.60 |
| 2:B:176:SER:HB2 | 2:B:178:ARG:HH21 | 1.67 | 0.60 |
| 2:H:294:ILE:HG23 | 2:H:296:ASP:H | 1.67 | 0.59 |
| 2:K:2496:VAL:HG12 | 2:K:2498:ASP:H | 1.67 | 0.59 |
| 2:E:793:LEU:HD12 | 2:E:797:HIS:HB2 | 1.84 | 0.59 |
| 2:H:793:LEU:HD12 | 2:H:797:HIS:HB2 | 1.84 | 0.59 |
| 2:H:176:SER:HB2 | 2:H:178:ARG:HH21 | 1.67 | 0.59 |
| 2:K:176:SER:HB2 | 2:K:178:ARG:HH21 | 1.67 | 0.59 |
| 2:B:793:LEU:HD12 | 2:B:797:HIS:HB2 | 1.84 | 0.58 |
| 2:B:1974:GLN:HG2 | 2:B:3637:LEU:HB3 | 1.86 | 0.58 |
| 2:B:2496:VAL:HG12 | 2:B:2498:ASP:H | 1.67 | 0.58 |
| 2:E:1974:GLN:HG2 | 2:E:3637:LEU:HB3 | 1.86 | 0.58 |
| 2:E:3946:PHE:HE2 | 2:E:4011:LEU:HD21 | 1.69 | 0.58 |
| 2:K:523:TYR:OH | 2:K:553:ARG:NH1 | 2.37 | 0.58 |
| 2:B:3946:PHE:HE2 | 2:B:4011:LEU:HD21 | 1.69 | 0.57 |
| 2:H:523:TYR:OH | 2:H:553:ARG:NH1 | 2.37 | 0.57 |
| 2:K:793:LEU:HD12 | 2:K:797:HIS:HB2 | 1.84 | 0.57 |
| 2:B:523:TYR:OH | 2:B:553:ARG:NH1 | 2.37 | 0.57 |
| 2:E:523:TYR:OH | 2:E:553:ARG:NH1 | 2.37 | 0.57 |
| 2:B:568:LEU:HD13 | 2:B:606:LEU:HD21 | 1.87 | 0.57 |
| 2:H:568:LEU:HD13 | 2:H:606:LEU:HD21 | 1.87 | 0.57 |
| 2:K:3765:LEU:HB3 | 2:K:3770:ALA:HB3 | 1.86 | 0.57 |

Continued on next page...

Continued from previous page...

| Atom-1 | Atom-2 | Interatomic distance (Å) | Clash overlap (Å) |
|-------------------|-------------------|--------------------------|-------------------|
| 2:K:1521:ASP:HB3 | 2:K:1525:GLY:HA3 | 1.87 | 0.57 |
| 2:B:1521:ASP:HB3 | 2:B:1525:GLY:HA3 | 1.87 | 0.57 |
| 2:E:568:LEU:HD13 | 2:E:606:LEU:HD21 | 1.87 | 0.57 |
| 2:H:3946:PHE:HE2 | 2:H:4011:LEU:HD21 | 1.69 | 0.57 |
| 2:B:24:CYS:SG | 2:B:25:ASN:N | 2.78 | 0.57 |
| 2:B:4922:VAL:HA | 2:B:4926:LEU:HB3 | 1.87 | 0.57 |
| 2:H:1521:ASP:HB3 | 2:H:1525:GLY:HA3 | 1.87 | 0.57 |
| 2:B:4934:ILE:HG21 | 2:E:4925:ILE:HG23 | 1.87 | 0.56 |
| 2:H:3765:LEU:HB3 | 2:H:3770:ALA:HB3 | 1.86 | 0.56 |
| 2:K:568:LEU:HD13 | 2:K:606:LEU:HD21 | 1.87 | 0.56 |
| 2:K:3946:PHE:HE2 | 2:K:4011:LEU:HD21 | 1.69 | 0.56 |
| 2:E:4934:ILE:HG21 | 2:H:4925:ILE:HG23 | 1.87 | 0.56 |
| 2:H:1974:GLN:HG2 | 2:H:3637:LEU:HB3 | 1.86 | 0.56 |
| 2:K:24:CYS:SG | 2:K:25:ASN:N | 2.78 | 0.56 |
| 2:K:2470:ILE:HG21 | 2:K:2503:MET:HG3 | 1.88 | 0.56 |
| 2:K:4922:VAL:HA | 2:K:4926:LEU:HB3 | 1.87 | 0.56 |
| 1:D:88:PRO:HB3 | 2:E:623:GLU:HG2 | 1.88 | 0.56 |
| 2:E:24:CYS:SG | 2:E:25:ASN:N | 2.78 | 0.56 |
| 2:K:1974:GLN:HG2 | 2:K:3637:LEU:HB3 | 1.86 | 0.56 |
| 2:E:2164:ARG:NH2 | 2:E:2202:LEU:O | 2.39 | 0.56 |
| 2:H:4922:VAL:HA | 2:H:4926:LEU:HB3 | 1.87 | 0.56 |
| 2:E:4922:VAL:HA | 2:E:4926:LEU:HB3 | 1.87 | 0.56 |
| 2:K:3692:ASP:OD2 | 2:K:3768:ARG:NH2 | 2.39 | 0.56 |
| 2:B:2164:ARG:NH2 | 2:B:2202:LEU:O | 2.39 | 0.56 |
| 2:E:233:ILE:O | 2:E:257:ARG:NH1 | 2.39 | 0.56 |
| 1:A:88:PRO:HB3 | 2:B:623:GLU:HG2 | 1.88 | 0.56 |
| 1:G:88:PRO:HB3 | 2:H:623:GLU:HG2 | 1.88 | 0.56 |
| 2:H:3692:ASP:OD2 | 2:H:3768:ARG:NH2 | 2.39 | 0.56 |
| 2:K:2164:ARG:NH2 | 2:K:2202:LEU:O | 2.39 | 0.56 |
| 2:B:2470:ILE:HG21 | 2:B:2503:MET:HG3 | 1.88 | 0.56 |
| 2:E:2470:ILE:HG21 | 2:E:2503:MET:HG3 | 1.88 | 0.56 |
| 2:H:233:ILE:O | 2:H:257:ARG:NH1 | 2.39 | 0.56 |
| 2:H:4576:LEU:HA | 2:K:4877:MET:HG2 | 1.88 | 0.56 |
| 2:K:233:ILE:O | 2:K:257:ARG:NH1 | 2.39 | 0.56 |
| 2:H:2470:ILE:HG21 | 2:H:2503:MET:HG3 | 1.88 | 0.56 |
| 2:B:3765:LEU:HB3 | 2:B:3770:ALA:HB3 | 1.86 | 0.56 |
| 2:B:4877:MET:HG2 | 2:K:4576:LEU:HA | 1.88 | 0.56 |
| 2:E:3692:ASP:OD2 | 2:E:3768:ARG:NH2 | 2.39 | 0.56 |
| 2:H:4934:ILE:HG21 | 2:K:4925:ILE:HG23 | 1.87 | 0.56 |
| 2:E:1215:ALA:HA | 2:E:1219:LEU:HB2 | 1.88 | 0.55 |
| 2:E:3765:LEU:HB3 | 2:E:3770:ALA:HB3 | 1.86 | 0.55 |

Continued on next page...

Continued from previous page...

| Atom-1 | Atom-2 | Interatomic distance (Å) | Clash overlap (Å) |
|-------------------|-------------------|--------------------------|-------------------|
| 2:H:24:CYS:SG | 2:H:25:ASN:N | 2.78 | 0.55 |
| 2:B:233:ILE:O | 2:B:257:ARG:NH1 | 2.39 | 0.55 |
| 2:B:618:GLN:OE1 | 2:B:1678:ASN:ND2 | 2.39 | 0.55 |
| 2:E:1521:ASP:HB3 | 2:E:1525:GLY:HA3 | 1.87 | 0.55 |
| 2:K:618:GLN:OE1 | 2:K:1678:ASN:ND2 | 2.39 | 0.55 |
| 2:K:1215:ALA:HA | 2:K:1219:LEU:HB2 | 1.88 | 0.55 |
| 2:B:1215:ALA:HA | 2:B:1219:LEU:HB2 | 1.88 | 0.55 |
| 2:H:1215:ALA:HA | 2:H:1219:LEU:HB2 | 1.88 | 0.55 |
| 2:K:4706:THR:HG22 | 2:K:4708:SER:H | 1.71 | 0.55 |
| 2:B:3692:ASP:OD2 | 2:B:3768:ARG:NH2 | 2.39 | 0.55 |
| 2:B:4925:ILE:HG23 | 2:K:4934:ILE:HG21 | 1.87 | 0.55 |
| 2:H:2164:ARG:NH2 | 2:H:2202:LEU:O | 2.39 | 0.55 |
| 2:B:4961:ILE:HD11 | 2:B:4965:TYR:HB2 | 1.89 | 0.55 |
| 2:E:2443:LEU:HD12 | 2:E:2444:ILE:HG13 | 1.89 | 0.55 |
| 2:K:4961:ILE:HD11 | 2:K:4965:TYR:HB2 | 1.89 | 0.55 |
| 2:B:842:PRO:HD3 | 2:B:1073:ARG:HG2 | 1.89 | 0.55 |
| 2:E:4961:ILE:HD11 | 2:E:4965:TYR:HB2 | 1.89 | 0.54 |
| 2:E:5025:CYS:SG | 2:E:5026:PHE:N | 2.80 | 0.54 |
| 2:H:618:GLN:OE1 | 2:H:1678:ASN:ND2 | 2.39 | 0.54 |
| 1:J:88:PRO:HB3 | 2:K:623:GLU:HG2 | 1.88 | 0.54 |
| 2:K:842:PRO:HD3 | 2:K:1073:ARG:HG2 | 1.89 | 0.54 |
| 2:B:1928:LEU:O | 2:B:2105:ARG:NH2 | 2.41 | 0.54 |
| 2:B:4576:LEU:HA | 2:E:4877:MET:HG2 | 1.88 | 0.54 |
| 2:E:618:GLN:OE1 | 2:E:1678:ASN:ND2 | 2.39 | 0.54 |
| 2:B:4706:THR:HG22 | 2:B:4708:SER:H | 1.71 | 0.54 |
| 2:E:842:PRO:HD3 | 2:E:1073:ARG:HG2 | 1.89 | 0.54 |
| 2:E:4706:THR:HG22 | 2:E:4708:SER:H | 1.71 | 0.54 |
| 2:H:1928:LEU:O | 2:H:2105:ARG:NH2 | 2.41 | 0.54 |
| 2:H:4961:ILE:HD11 | 2:H:4965:TYR:HB2 | 1.89 | 0.54 |
| 2:K:1928:LEU:O | 2:K:2105:ARG:NH2 | 2.41 | 0.54 |
| 2:E:4576:LEU:HA | 2:H:4877:MET:HG2 | 1.88 | 0.54 |
| 2:H:5025:CYS:SG | 2:H:5026:PHE:N | 2.80 | 0.54 |
| 2:B:2443:LEU:HD12 | 2:B:2444:ILE:HG13 | 1.89 | 0.54 |
| 2:B:5025:CYS:SG | 2:B:5026:PHE:N | 2.80 | 0.54 |
| 2:H:4706:THR:HG22 | 2:H:4708:SER:H | 1.71 | 0.54 |
| 2:K:5025:CYS:SG | 2:K:5026:PHE:N | 2.80 | 0.54 |
| 2:E:793:LEU:H | 2:E:798:GLY:HA3 | 1.73 | 0.53 |
| 2:B:3711:LYS:NZ | 2:B:3784:GLU:OE2 | 2.39 | 0.53 |
| 2:E:1928:LEU:O | 2:E:2105:ARG:NH2 | 2.41 | 0.53 |
| 2:H:622:THR:HG23 | 2:H:626:LEU:HD22 | 1.90 | 0.53 |
| 2:H:842:PRO:HD3 | 2:H:1073:ARG:HG2 | 1.89 | 0.53 |

Continued on next page...

Continued from previous page...

| Atom-1 | Atom-2 | Interatomic distance (Å) | Clash overlap (Å) |
|-------------------|-------------------|--------------------------|-------------------|
| 1:J:74:LEU:HD22 | 1:J:101:VAL:HG21 | 1.91 | 0.53 |
| 2:B:793:LEU:H | 2:B:798:GLY:HA3 | 1.73 | 0.53 |
| 1:G:74:LEU:HD22 | 1:G:101:VAL:HG21 | 1.91 | 0.53 |
| 2:K:2443:LEU:HD12 | 2:K:2444:ILE:HG13 | 1.89 | 0.53 |
| 2:K:472:ARG:NH1 | 2:K:532:GLY:O | 2.42 | 0.53 |
| 2:K:547:LEU:HD22 | 2:K:564:LEU:HD13 | 1.91 | 0.53 |
| 2:E:622:THR:HG23 | 2:E:626:LEU:HD22 | 1.90 | 0.53 |
| 2:H:638:ILE:HD13 | 2:H:703:GLY:HA2 | 1.91 | 0.53 |
| 3:L:29:THR:O | 3:L:33:LEU:N | 2.40 | 0.53 |
| 2:B:472:ARG:NH1 | 2:B:532:GLY:O | 2.42 | 0.52 |
| 2:B:547:LEU:HD22 | 2:B:564:LEU:HD13 | 1.91 | 0.52 |
| 2:B:2336:LEU:HB2 | 2:B:2433:LEU:HD11 | 1.91 | 0.52 |
| 2:H:1466:LEU:HD23 | 2:H:1496:TRP:HE3 | 1.74 | 0.52 |
| 2:K:1466:LEU:HD23 | 2:K:1496:TRP:HE3 | 1.74 | 0.52 |
| 1:A:74:LEU:HD22 | 1:A:101:VAL:HG21 | 1.91 | 0.52 |
| 2:E:638:ILE:HD13 | 2:E:703:GLY:HA2 | 1.91 | 0.52 |
| 2:H:472:ARG:NH1 | 2:H:532:GLY:O | 2.42 | 0.52 |
| 2:K:1955:ARG:NH1 | 2:K:2043:CYS:SG | 2.82 | 0.52 |
| 2:B:1436:SER:HA | 2:B:1517:GLY:HA2 | 1.92 | 0.52 |
| 1:D:35:LYS:HD3 | 1:D:38:SER:HB2 | 1.91 | 0.52 |
| 2:H:793:LEU:H | 2:H:798:GLY:HA3 | 1.73 | 0.52 |
| 2:K:793:LEU:H | 2:K:798:GLY:HA3 | 1.73 | 0.52 |
| 2:K:1594:ARG:NH1 | 2:K:1643:GLU:OE2 | 2.42 | 0.52 |
| 1:A:35:LYS:HD3 | 1:A:38:SER:HB2 | 1.91 | 0.52 |
| 2:B:622:THR:HG23 | 2:B:626:LEU:HD22 | 1.90 | 0.52 |
| 2:B:1594:ARG:NH1 | 2:B:1643:GLU:OE2 | 2.42 | 0.52 |
| 1:D:74:LEU:HD22 | 1:D:101:VAL:HG21 | 1.91 | 0.52 |
| 2:H:2336:LEU:HB2 | 2:H:2433:LEU:HD11 | 1.91 | 0.52 |
| 2:H:4133:ASP:O | 2:H:4137:ASN:ND2 | 2.41 | 0.52 |
| 2:B:4054:LEU:HD13 | 2:B:4162:ALA:HB2 | 1.92 | 0.52 |
| 2:E:1955:ARG:NH1 | 2:E:2043:CYS:SG | 2.82 | 0.52 |
| 2:H:1594:ARG:NH1 | 2:H:1643:GLU:OE2 | 2.42 | 0.52 |
| 2:H:1955:ARG:NH1 | 2:H:2043:CYS:SG | 2.82 | 0.52 |
| 2:B:1955:ARG:NH1 | 2:B:2043:CYS:SG | 2.82 | 0.52 |
| 2:E:1594:ARG:NH1 | 2:E:1643:GLU:OE2 | 2.42 | 0.52 |
| 2:H:2443:LEU:HD12 | 2:H:2444:ILE:HG13 | 1.89 | 0.52 |
| 2:K:2166:LEU:HG | 2:K:2178:LEU:HD22 | 1.92 | 0.52 |
| 2:B:168:ASP:OD1 | 2:B:168:ASP:N | 2.43 | 0.52 |
| 2:E:4054:LEU:HD13 | 2:E:4162:ALA:HB2 | 1.92 | 0.52 |
| 2:H:4054:LEU:HD13 | 2:H:4162:ALA:HB2 | 1.92 | 0.52 |
| 2:K:1436:SER:HA | 2:K:1517:GLY:HA2 | 1.92 | 0.52 |

Continued on next page...

Continued from previous page...

| Atom-1 | Atom-2 | Interatomic distance (Å) | Clash overlap (Å) |
|-------------------|-------------------|--------------------------|-------------------|
| 2:K:622:THR:HG23 | 2:K:626:LEU:HD22 | 1.90 | 0.52 |
| 2:E:472:ARG:NH1 | 2:E:532:GLY:O | 2.42 | 0.52 |
| 2:E:547:LEU:HD22 | 2:E:564:LEU:HD13 | 1.91 | 0.52 |
| 2:H:547:LEU:HD22 | 2:H:564:LEU:HD13 | 1.91 | 0.52 |
| 2:B:638:ILE:HD13 | 2:B:703:GLY:HA2 | 1.91 | 0.52 |
| 2:B:4133:ASP:O | 2:B:4137:ASN:ND2 | 2.41 | 0.52 |
| 2:E:2336:LEU:HB2 | 2:E:2433:LEU:HD11 | 1.91 | 0.52 |
| 1:J:35:LYS:HD3 | 1:J:38:SER:HB2 | 1.91 | 0.51 |
| 2:B:1466:LEU:HD23 | 2:B:1496:TRP:HE3 | 1.74 | 0.51 |
| 2:E:1466:LEU:HD23 | 2:E:1496:TRP:HE3 | 1.74 | 0.51 |
| 2:H:1436:SER:HA | 2:H:1517:GLY:HA2 | 1.92 | 0.51 |
| 2:K:4133:ASP:O | 2:K:4137:ASN:ND2 | 2.41 | 0.51 |
| 2:H:2166:LEU:HG | 2:H:2178:LEU:HD22 | 1.92 | 0.51 |
| 2:K:2336:LEU:HB2 | 2:K:2433:LEU:HD11 | 1.91 | 0.51 |
| 1:G:35:LYS:HD3 | 1:G:38:SER:HB2 | 1.91 | 0.51 |
| 3:I:29:THR:O | 3:I:33:LEU:N | 2.40 | 0.51 |
| 2:K:168:ASP:OD1 | 2:K:168:ASP:N | 2.43 | 0.51 |
| 2:K:3711:LYS:NZ | 2:K:3784:GLU:OE2 | 2.39 | 0.51 |
| 2:E:4177:GLU:CB | 2:E:4981:HIS:HE1 | 2.23 | 0.51 |
| 2:K:638:ILE:HD13 | 2:K:703:GLY:HA2 | 1.91 | 0.51 |
| 3:F:29:THR:O | 3:F:33:LEU:N | 2.40 | 0.51 |
| 2:B:2166:LEU:HG | 2:B:2178:LEU:HD22 | 1.92 | 0.51 |
| 2:H:4177:GLU:CB | 2:H:4981:HIS:HE1 | 2.24 | 0.51 |
| 2:E:1438:ARG:HG2 | 2:E:1515:VAL:HG12 | 1.93 | 0.51 |
| 2:K:1289:LEU:HD12 | 2:K:1562:ILE:HD11 | 1.93 | 0.51 |
| 2:K:4054:LEU:HD13 | 2:K:4162:ALA:HB2 | 1.92 | 0.51 |
| 2:E:4133:ASP:O | 2:E:4137:ASN:ND2 | 2.41 | 0.51 |
| 2:K:1438:ARG:HG2 | 2:K:1515:VAL:HG12 | 1.93 | 0.51 |
| 2:B:1289:LEU:HD12 | 2:B:1562:ILE:HD11 | 1.93 | 0.50 |
| 2:H:168:ASP:OD1 | 2:H:168:ASP:N | 2.43 | 0.50 |
| 2:B:1597:MET:SD | 2:B:1597:MET:N | 2.85 | 0.50 |
| 2:E:1436:SER:HA | 2:E:1517:GLY:HA2 | 1.92 | 0.50 |
| 2:E:3711:LYS:NZ | 2:E:3784:GLU:OE2 | 2.39 | 0.50 |
| 3:C:29:THR:O | 3:C:33:LEU:N | 2.40 | 0.50 |
| 2:E:1831:VAL:HB | 2:E:1838:GLN:HG3 | 1.94 | 0.50 |
| 2:H:1438:ARG:HG2 | 2:H:1515:VAL:HG12 | 1.93 | 0.50 |
| 2:K:1597:MET:SD | 2:K:1597:MET:N | 2.85 | 0.50 |
| 2:B:308:HIS:CD2 | 2:B:311:ALA:H | 2.30 | 0.50 |
| 2:B:2473:LEU:HD12 | 2:B:2474:PRO:HD2 | 1.94 | 0.50 |
| 2:E:308:HIS:CD2 | 2:E:311:ALA:H | 2.30 | 0.50 |
| 2:H:1831:VAL:HB | 2:H:1838:GLN:HG3 | 1.94 | 0.50 |

Continued on next page...

Continued from previous page...

| Atom-1 | Atom-2 | Interatomic distance (Å) | Clash overlap (Å) |
|-------------------|-------------------|--------------------------|-------------------|
| 2:K:308:HIS:CD2 | 2:K:311:ALA:H | 2.30 | 0.50 |
| 2:B:1438:ARG:HG2 | 2:B:1515:VAL:HG12 | 1.93 | 0.50 |
| 2:E:2166:LEU:HG | 2:E:2178:LEU:HD22 | 1.92 | 0.50 |
| 2:H:1597:MET:SD | 2:H:1597:MET:N | 2.85 | 0.50 |
| 2:K:3884:GLN:OE1 | 2:K:3955:GLN:NE2 | 2.45 | 0.50 |
| 2:E:161:GLU:OE2 | 2:E:164:ARG:NH2 | 2.45 | 0.50 |
| 2:E:2473:LEU:HD12 | 2:E:2474:PRO:HD2 | 1.94 | 0.50 |
| 2:H:308:HIS:CD2 | 2:H:311:ALA:H | 2.30 | 0.50 |
| 2:H:2200:ARG:NH2 | 2:H:2246:GLN:OE1 | 2.45 | 0.50 |
| 2:K:1831:VAL:HB | 2:K:1838:GLN:HG3 | 1.94 | 0.50 |
| 2:K:4679:LEU:HD12 | 2:K:4683:GLY:HA2 | 1.94 | 0.50 |
| 2:B:3884:GLN:OE1 | 2:B:3955:GLN:NE2 | 2.45 | 0.50 |
| 2:E:1597:MET:SD | 2:E:1597:MET:N | 2.85 | 0.50 |
| 2:H:1289:LEU:HD12 | 2:H:1562:ILE:HD11 | 1.93 | 0.50 |
| 2:H:4679:LEU:HD12 | 2:H:4683:GLY:HA2 | 1.94 | 0.50 |
| 2:B:1743:ARG:NH1 | 2:B:1964:GLU:OE2 | 2.44 | 0.50 |
| 2:K:161:GLU:OE2 | 2:K:164:ARG:NH2 | 2.45 | 0.50 |
| 2:H:4686:ILE:HG22 | 2:H:4687:THR:HG23 | 1.94 | 0.49 |
| 2:E:1289:LEU:HD12 | 2:E:1562:ILE:HD11 | 1.93 | 0.49 |
| 2:H:3884:GLN:OE1 | 2:H:3955:GLN:NE2 | 2.45 | 0.49 |
| 2:K:2200:ARG:NH2 | 2:K:2246:GLN:OE1 | 2.45 | 0.49 |
| 2:K:4686:ILE:HG22 | 2:K:4687:THR:HG23 | 1.94 | 0.49 |
| 2:E:3884:GLN:OE1 | 2:E:3955:GLN:NE2 | 2.45 | 0.49 |
| 2:B:1735:ILE:HG22 | 2:B:2143:TYR:HB3 | 1.95 | 0.49 |
| 2:B:1831:VAL:HB | 2:B:1838:GLN:HG3 | 1.94 | 0.49 |
| 2:K:1695:LEU:HD11 | 2:K:1808:LEU:HD11 | 1.95 | 0.49 |
| 2:E:2200:ARG:NH2 | 2:E:2246:GLN:OE1 | 2.45 | 0.49 |
| 1:G:90:VAL:HG23 | 1:G:91:ILE:HG12 | 1.95 | 0.49 |
| 2:H:1695:LEU:HD11 | 2:H:1808:LEU:HD11 | 1.95 | 0.49 |
| 2:H:2473:LEU:HD12 | 2:H:2474:PRO:HD2 | 1.94 | 0.49 |
| 2:B:161:GLU:OE2 | 2:B:164:ARG:NH2 | 2.45 | 0.49 |
| 2:B:1290:ARG:HG3 | 2:B:1551:ALA:HB2 | 1.95 | 0.49 |
| 2:E:1695:LEU:HD11 | 2:E:1808:LEU:HD11 | 1.95 | 0.49 |
| 2:H:1743:ARG:NH1 | 2:H:1964:GLU:OE2 | 2.44 | 0.49 |
| 2:B:4679:LEU:HD12 | 2:B:4683:GLY:HA2 | 1.94 | 0.49 |
| 2:E:4679:LEU:HD12 | 2:E:4683:GLY:HA2 | 1.94 | 0.49 |
| 2:H:649:PHE:HB3 | 2:H:776:LEU:HD13 | 1.95 | 0.49 |
| 1:A:90:VAL:HG23 | 1:A:91:ILE:HG12 | 1.95 | 0.48 |
| 2:B:649:PHE:HB3 | 2:B:776:LEU:HD13 | 1.95 | 0.48 |
| 2:K:2473:LEU:HD12 | 2:K:2474:PRO:HD2 | 1.94 | 0.48 |
| 2:B:1075:PHE:HB2 | 2:B:1192:CYS:HB3 | 1.95 | 0.48 |

Continued on next page...

Continued from previous page...

| Atom-1 | Atom-2 | Interatomic distance (Å) | Clash overlap (Å) |
|-------------------|-------------------|--------------------------|-------------------|
| 2:E:2517:ASP:HA | 2:E:2569:LEU:HD21 | 1.95 | 0.48 |
| 2:K:649:PHE:HB3 | 2:K:776:LEU:HD13 | 1.95 | 0.48 |
| 2:K:1290:ARG:HG3 | 2:K:1551:ALA:HB2 | 1.95 | 0.48 |
| 2:K:1735:ILE:HG22 | 2:K:2143:TYR:HB3 | 1.95 | 0.48 |
| 2:K:2163:ILE:HD11 | 2:K:2179:MET:HG3 | 1.95 | 0.48 |
| 2:B:2200:ARG:NH2 | 2:B:2246:GLN:OE1 | 2.45 | 0.48 |
| 2:E:350:HIS:HB3 | 2:E:354:GLY:H | 1.79 | 0.48 |
| 2:E:1075:PHE:HB2 | 2:E:1192:CYS:HB3 | 1.95 | 0.48 |
| 2:E:1735:ILE:HG22 | 2:E:2143:TYR:HB3 | 1.95 | 0.48 |
| 2:H:2517:ASP:HA | 2:H:2569:LEU:HD21 | 1.95 | 0.48 |
| 2:B:1093:GLU:HB3 | 2:B:1201:HIS:HB3 | 1.95 | 0.48 |
| 2:B:1695:LEU:HD11 | 2:B:1808:LEU:HD11 | 1.95 | 0.48 |
| 2:B:2103:VAL:HG11 | 2:B:2125:LEU:HD13 | 1.95 | 0.48 |
| 2:B:4686:ILE:HG22 | 2:B:4687:THR:HG23 | 1.94 | 0.48 |
| 2:E:4686:ILE:HG22 | 2:E:4687:THR:HG23 | 1.94 | 0.48 |
| 2:H:3711:LYS:NZ | 2:H:3784:GLU:OE2 | 2.39 | 0.48 |
| 2:B:4802:TYR:CE2 | 2:B:4804:ASN:HB2 | 2.49 | 0.48 |
| 2:E:649:PHE:HB3 | 2:E:776:LEU:HD13 | 1.95 | 0.48 |
| 2:H:884:LEU:HD11 | 2:H:969:PRO:HA | 1.95 | 0.48 |
| 2:B:2163:ILE:HD11 | 2:B:2179:MET:HG3 | 1.95 | 0.48 |
| 1:D:90:VAL:HG23 | 1:D:91:ILE:HG12 | 1.95 | 0.48 |
| 2:H:1735:ILE:HG22 | 2:H:2143:TYR:HB3 | 1.95 | 0.48 |
| 2:K:4802:TYR:CE2 | 2:K:4804:ASN:HB2 | 2.49 | 0.48 |
| 2:B:4234:GLU:OE2 | 2:B:5012:TYR:OH | 2.30 | 0.48 |
| 2:E:2163:ILE:HD11 | 2:E:2179:MET:HG3 | 1.95 | 0.48 |
| 2:H:1093:GLU:HB3 | 2:H:1201:HIS:HB3 | 1.95 | 0.48 |
| 2:H:2103:VAL:HG11 | 2:H:2125:LEU:HD13 | 1.95 | 0.48 |
| 2:B:530:ILE:HG21 | 2:B:567:VAL:HG12 | 1.96 | 0.48 |
| 1:D:4:ILE:HD13 | 1:D:65:GLN:HG2 | 1.96 | 0.48 |
| 2:K:2517:ASP:HA | 2:K:2569:LEU:HD21 | 1.95 | 0.48 |
| 1:D:78:PRO:HG3 | 1:D:96:THR:HA | 1.96 | 0.48 |
| 2:H:350:HIS:HB3 | 2:H:354:GLY:H | 1.79 | 0.48 |
| 2:K:350:HIS:HB3 | 2:K:354:GLY:H | 1.79 | 0.48 |
| 2:K:530:ILE:HG21 | 2:K:567:VAL:HG12 | 1.96 | 0.48 |
| 1:A:78:PRO:HG3 | 1:A:96:THR:HA | 1.96 | 0.47 |
| 2:E:1454:THR:HG22 | 2:E:1456:ASP:H | 1.79 | 0.47 |
| 2:H:161:GLU:OE2 | 2:H:164:ARG:NH2 | 2.45 | 0.47 |
| 2:H:1290:ARG:HG3 | 2:H:1551:ALA:HB2 | 1.95 | 0.47 |
| 2:H:3834:CYS:HG | 2:H:3917:TYR:HH | 1.60 | 0.47 |
| 1:J:90:VAL:HG23 | 1:J:91:ILE:HG12 | 1.95 | 0.47 |
| 2:B:1643:GLU:HG3 | 2:B:1644:GLU:HG3 | 1.96 | 0.47 |

Continued on next page...

Continued from previous page...

| Atom-1 | Atom-2 | Interatomic distance (Å) | Clash overlap (Å) |
|-------------------|-------------------|--------------------------|-------------------|
| 2:K:1454:THR:HG22 | 2:K:1456:ASP:H | 1.79 | 0.47 |
| 2:K:3880:PHE:HE1 | 2:K:3914:THR:HG23 | 1.79 | 0.47 |
| 2:B:2517:ASP:HA | 2:B:2569:LEU:HD21 | 1.95 | 0.47 |
| 2:E:168:ASP:N | 2:E:168:ASP:OD1 | 2.43 | 0.47 |
| 2:E:2103:VAL:HG11 | 2:E:2125:LEU:HD13 | 1.95 | 0.47 |
| 2:K:2103:VAL:HG11 | 2:K:2125:LEU:HD13 | 1.95 | 0.47 |
| 2:B:350:HIS:HB3 | 2:B:354:GLY:H | 1.79 | 0.47 |
| 2:B:1454:THR:HG22 | 2:B:1456:ASP:H | 1.79 | 0.47 |
| 2:B:4886:TYR:HD2 | 2:B:4887:VAL:HG13 | 1.80 | 0.47 |
| 2:E:3880:PHE:HE1 | 2:E:3914:THR:HG23 | 1.79 | 0.47 |
| 2:H:530:ILE:HG21 | 2:H:567:VAL:HG12 | 1.96 | 0.47 |
| 1:J:78:PRO:HG3 | 1:J:96:THR:HA | 1.96 | 0.47 |
| 2:B:884:LEU:HD11 | 2:B:969:PRO:HA | 1.95 | 0.47 |
| 2:E:1290:ARG:HG3 | 2:E:1551:ALA:HB2 | 1.95 | 0.47 |
| 2:H:676:THR:OG1 | 2:H:677:ALA:N | 2.46 | 0.47 |
| 2:H:3880:PHE:HE1 | 2:H:3914:THR:HG23 | 1.79 | 0.47 |
| 2:K:884:LEU:HD11 | 2:K:969:PRO:HA | 1.95 | 0.47 |
| 1:A:4:ILE:HD13 | 1:A:65:GLN:HG2 | 1.96 | 0.47 |
| 2:B:3880:PHE:HE1 | 2:B:3914:THR:HG23 | 1.79 | 0.47 |
| 2:K:676:THR:OG1 | 2:K:677:ALA:N | 2.46 | 0.47 |
| 2:E:530:ILE:HG21 | 2:E:567:VAL:HG12 | 1.96 | 0.47 |
| 2:E:676:THR:OG1 | 2:E:677:ALA:N | 2.46 | 0.47 |
| 2:E:884:LEU:HD11 | 2:E:969:PRO:HA | 1.95 | 0.47 |
| 2:E:1093:GLU:HB3 | 2:E:1201:HIS:HB3 | 1.95 | 0.47 |
| 1:G:78:PRO:HG3 | 1:G:96:THR:HA | 1.96 | 0.47 |
| 2:H:2163:ILE:HD11 | 2:H:2179:MET:HG3 | 1.95 | 0.47 |
| 2:H:4802:TYR:CE2 | 2:H:4804:ASN:HB2 | 2.49 | 0.47 |
| 2:K:1075:PHE:HB2 | 2:K:1192:CYS:HB3 | 1.95 | 0.47 |
| 2:K:1093:GLU:HB3 | 2:K:1201:HIS:HB3 | 1.95 | 0.47 |
| 2:K:1643:GLU:HG3 | 2:K:1644:GLU:HG3 | 1.96 | 0.47 |
| 2:K:4234:GLU:OE2 | 2:K:5012:TYR:OH | 2.30 | 0.47 |
| 2:K:4886:TYR:HD2 | 2:K:4887:VAL:HG13 | 1.80 | 0.47 |
| 2:B:2239:TYR:OH | 3:C:68:GLU:OE2 | 2.33 | 0.47 |
| 2:E:746:CYS:HA | 2:E:757:PHE:HA | 1.97 | 0.47 |
| 2:E:2454:ILE:HA | 2:E:2457:ILE:HD12 | 1.96 | 0.47 |
| 2:H:616:SER:O | 2:H:620:LEU:HD13 | 2.15 | 0.47 |
| 2:H:1075:PHE:HB2 | 2:H:1192:CYS:HB3 | 1.95 | 0.47 |
| 2:H:4886:TYR:HD2 | 2:H:4887:VAL:HG13 | 1.80 | 0.47 |
| 2:E:4802:TYR:CE2 | 2:E:4804:ASN:HB2 | 2.49 | 0.47 |
| 2:K:616:SER:O | 2:K:620:LEU:HD13 | 2.15 | 0.47 |
| 2:K:2454:ILE:HA | 2:K:2457:ILE:HD12 | 1.96 | 0.47 |

Continued on next page...

Continued from previous page...

| Atom-1 | Atom-2 | Interatomic distance (Å) | Clash overlap (Å) |
|-------------------|-------------------|--------------------------|-------------------|
| 2:H:1454:THR:HG22 | 2:H:1456:ASP:H | 1.79 | 0.47 |
| 2:H:2454:ILE:HA | 2:H:2457:ILE:HD12 | 1.96 | 0.47 |
| 2:B:529:LEU:O | 2:B:536:ASN:ND2 | 2.48 | 0.46 |
| 2:E:1643:GLU:HG3 | 2:E:1644:GLU:HG3 | 1.96 | 0.46 |
| 2:H:1443:GLN:HA | 2:H:1557:THR:HG21 | 1.97 | 0.46 |
| 1:J:4:ILE:HD13 | 1:J:65:GLN:HG2 | 1.96 | 0.46 |
| 2:E:1641:ILE:HG22 | 2:E:1643:GLU:HG2 | 1.98 | 0.46 |
| 2:H:529:LEU:O | 2:H:536:ASN:ND2 | 2.48 | 0.46 |
| 1:J:74:LEU:HD13 | 1:J:101:VAL:HB | 1.97 | 0.46 |
| 2:K:1743:ARG:NH1 | 2:K:1964:GLU:OE2 | 2.44 | 0.46 |
| 2:E:616:SER:O | 2:E:620:LEU:HD13 | 2.15 | 0.46 |
| 2:E:1130:GLN:HG3 | 2:E:1138:LEU:HA | 1.98 | 0.46 |
| 2:E:2461:LEU:HD12 | 2:E:2462:VAL:HG23 | 1.97 | 0.46 |
| 2:E:4886:TYR:HD2 | 2:E:4887:VAL:HG13 | 1.80 | 0.46 |
| 2:B:746:CYS:HA | 2:B:757:PHE:HA | 1.97 | 0.46 |
| 2:H:1641:ILE:HG22 | 2:H:1643:GLU:HG2 | 1.98 | 0.46 |
| 2:K:529:LEU:O | 2:K:536:ASN:ND2 | 2.48 | 0.46 |
| 2:B:616:SER:O | 2:B:620:LEU:HD13 | 2.15 | 0.46 |
| 2:B:2128:GLN:HE21 | 2:B:2128:GLN:HA | 1.80 | 0.46 |
| 2:B:2461:LEU:HD12 | 2:B:2462:VAL:HG23 | 1.97 | 0.46 |
| 2:E:892:THR:N | 2:E:902:ARG:O | 2.48 | 0.46 |
| 2:H:1643:GLU:HG3 | 2:H:1644:GLU:HG3 | 1.96 | 0.46 |
| 2:H:2461:LEU:HD12 | 2:H:2462:VAL:HG23 | 1.97 | 0.46 |
| 2:B:215:THR:OG1 | 2:B:271:GLY:O | 2.34 | 0.46 |
| 1:G:4:ILE:HD13 | 1:G:65:GLN:HG2 | 1.96 | 0.46 |
| 2:K:1130:GLN:HG3 | 2:K:1138:LEU:HA | 1.98 | 0.46 |
| 2:B:1443:GLN:HA | 2:B:1557:THR:HG21 | 1.97 | 0.46 |
| 2:E:529:LEU:O | 2:E:536:ASN:ND2 | 2.48 | 0.46 |
| 2:K:746:CYS:HA | 2:K:757:PHE:HA | 1.97 | 0.46 |
| 2:B:2454:ILE:HA | 2:B:2457:ILE:HD12 | 1.96 | 0.46 |
| 1:D:74:LEU:HD13 | 1:D:101:VAL:HB | 1.97 | 0.46 |
| 2:E:2128:GLN:HE21 | 2:E:2128:GLN:HA | 1.80 | 0.46 |
| 2:E:3804:ASN:HB2 | 2:E:3807:VAL:HG12 | 1.98 | 0.46 |
| 2:E:4234:GLU:OE2 | 2:E:5012:TYR:OH | 2.30 | 0.46 |
| 2:E:4553:LEU:HD11 | 2:E:4654:LEU:HD23 | 1.98 | 0.46 |
| 2:B:1641:ILE:HG22 | 2:B:1643:GLU:HG2 | 1.98 | 0.46 |
| 2:E:2475:LEU:HD23 | 2:E:2475:LEU:H | 1.81 | 0.46 |
| 2:H:2475:LEU:H | 2:H:2475:LEU:HD23 | 1.81 | 0.46 |
| 2:K:1252:HIS:CE1 | 2:K:1255:TYR:HD2 | 2.34 | 0.46 |
| 3:C:65:ASP:OD2 | 3:C:67:PRO:HD2 | 2.17 | 0.45 |
| 2:E:215:THR:OG1 | 2:E:271:GLY:O | 2.34 | 0.45 |

Continued on next page...

Continued from previous page...

| Atom-1 | Atom-2 | Interatomic distance (Å) | Clash overlap (Å) |
|-------------------|-------------------|--------------------------|-------------------|
| 2:E:1743:ARG:NH1 | 2:E:1964:GLU:OE2 | 2.44 | 0.45 |
| 2:K:215:THR:OG1 | 2:K:271:GLY:O | 2.34 | 0.45 |
| 2:K:4177:GLU:CB | 2:K:4981:HIS:HE1 | 2.30 | 0.45 |
| 2:B:3804:ASN:HB2 | 2:B:3807:VAL:HG12 | 1.98 | 0.45 |
| 2:K:668:VAL:HG11 | 2:K:682:LEU:HD21 | 1.99 | 0.45 |
| 2:K:2475:LEU:H | 2:K:2475:LEU:HD23 | 1.81 | 0.45 |
| 2:B:668:VAL:HG11 | 2:B:682:LEU:HD21 | 1.99 | 0.45 |
| 2:B:892:THR:N | 2:B:902:ARG:O | 2.48 | 0.45 |
| 2:B:1130:GLN:HG3 | 2:B:1138:LEU:HA | 1.98 | 0.45 |
| 2:B:2381:ILE:HD13 | 2:B:2470:ILE:HG13 | 1.99 | 0.45 |
| 2:E:2381:ILE:HD13 | 2:E:2470:ILE:HG13 | 1.99 | 0.45 |
| 2:H:2239:TYR:OH | 3:I:68:GLU:OE2 | 2.33 | 0.45 |
| 2:K:2461:LEU:HD12 | 2:K:2462:VAL:HG23 | 1.97 | 0.45 |
| 2:E:1443:GLN:HA | 2:E:1557:THR:HG21 | 1.97 | 0.45 |
| 1:G:74:LEU:HD13 | 1:G:101:VAL:HB | 1.97 | 0.45 |
| 2:H:892:THR:N | 2:H:902:ARG:O | 2.48 | 0.45 |
| 2:K:1443:GLN:HA | 2:K:1557:THR:HG21 | 1.97 | 0.45 |
| 2:E:167:ASP:OD1 | 2:E:167:ASP:N | 2.50 | 0.45 |
| 2:E:499:THR:HG22 | 2:E:500:ALA:H | 1.81 | 0.45 |
| 2:E:2378:LEU:HD12 | 2:E:2381:ILE:HD11 | 1.98 | 0.45 |
| 2:H:167:ASP:OD1 | 2:H:167:ASP:N | 2.50 | 0.45 |
| 2:H:1130:GLN:HG3 | 2:H:1138:LEU:HA | 1.98 | 0.45 |
| 2:K:1641:ILE:HG22 | 2:K:1643:GLU:HG2 | 1.98 | 0.45 |
| 1:A:74:LEU:HD13 | 1:A:101:VAL:HB | 1.97 | 0.45 |
| 3:F:65:ASP:OD2 | 3:F:67:PRO:HD2 | 2.17 | 0.45 |
| 2:H:2128:GLN:HA | 2:H:2128:GLN:HE21 | 1.80 | 0.45 |
| 3:I:65:ASP:OD2 | 3:I:67:PRO:HD2 | 2.17 | 0.45 |
| 2:K:1805:LEU:HD13 | 2:K:1854:ILE:HD12 | 1.99 | 0.45 |
| 2:H:215:THR:OG1 | 2:H:271:GLY:O | 2.34 | 0.45 |
| 2:K:2128:GLN:HE21 | 2:K:2128:GLN:HA | 1.80 | 0.45 |
| 2:K:2239:TYR:OH | 3:L:68:GLU:OE2 | 2.33 | 0.45 |
| 2:B:1805:LEU:HD13 | 2:B:1854:ILE:HD12 | 1.99 | 0.45 |
| 2:H:668:VAL:HG11 | 2:H:682:LEU:HD21 | 1.99 | 0.45 |
| 2:B:2284:ASN:ND2 | 2:B:2287:LEU:HD13 | 2.32 | 0.45 |
| 2:E:1805:LEU:HD13 | 2:E:1854:ILE:HD12 | 1.99 | 0.45 |
| 2:H:257:ARG:HA | 2:H:286:THR:HG21 | 1.99 | 0.45 |
| 2:H:2378:LEU:HD12 | 2:H:2381:ILE:HD11 | 1.98 | 0.45 |
| 2:K:167:ASP:N | 2:K:167:ASP:OD1 | 2.50 | 0.45 |
| 2:K:257:ARG:HA | 2:K:286:THR:HG21 | 1.99 | 0.45 |
| 3:L:65:ASP:OD2 | 3:L:67:PRO:HD2 | 2.17 | 0.45 |
| 2:B:2475:LEU:HD23 | 2:B:2475:LEU:H | 1.81 | 0.45 |

Continued on next page...

Continued from previous page...

| Atom-1 | Atom-2 | Interatomic distance (Å) | Clash overlap (Å) |
|-------------------|-------------------|--------------------------|-------------------|
| 2:E:668:VAL:HG11 | 2:E:682:LEU:HD21 | 1.99 | 0.45 |
| 2:H:2284:ASN:ND2 | 2:H:2287:LEU:HD13 | 2.32 | 0.45 |
| 2:H:3954:LYS:HA | 2:H:4014:LEU:HD13 | 1.99 | 0.45 |
| 2:K:3804:ASN:HB2 | 2:K:3807:VAL:HG12 | 1.98 | 0.45 |
| 2:B:676:THR:OG1 | 2:B:677:ALA:N | 2.46 | 0.44 |
| 2:B:2378:LEU:HD12 | 2:B:2381:ILE:HD11 | 1.98 | 0.44 |
| 2:B:4553:LEU:HD11 | 2:B:4654:LEU:HD23 | 1.98 | 0.44 |
| 2:H:499:THR:HG22 | 2:H:500:ALA:H | 1.81 | 0.44 |
| 2:H:4234:GLU:OE2 | 2:H:5012:TYR:OH | 2.30 | 0.44 |
| 2:B:1252:HIS:CE1 | 2:B:1255:TYR:HD2 | 2.34 | 0.44 |
| 2:E:1252:HIS:CE1 | 2:E:1255:TYR:HD2 | 2.34 | 0.44 |
| 2:H:1805:LEU:HD13 | 2:H:1854:ILE:HD12 | 1.99 | 0.44 |
| 2:H:4553:LEU:HD11 | 2:H:4654:LEU:HD23 | 1.98 | 0.44 |
| 2:K:1639:LEU:HD21 | 2:K:1650:ILE:HD13 | 1.99 | 0.44 |
| 2:K:2381:ILE:HD13 | 2:K:2470:ILE:HG13 | 1.99 | 0.44 |
| 2:H:746:CYS:HA | 2:H:757:PHE:HA | 1.97 | 0.44 |
| 2:B:499:THR:HG22 | 2:B:500:ALA:H | 1.81 | 0.44 |
| 2:H:1252:HIS:CE1 | 2:H:1255:TYR:HD2 | 2.34 | 0.44 |
| 2:H:2381:ILE:HD13 | 2:H:2470:ILE:HG13 | 1.99 | 0.44 |
| 2:K:4553:LEU:HD11 | 2:K:4654:LEU:HD23 | 1.98 | 0.44 |
| 2:E:2284:ASN:ND2 | 2:E:2287:LEU:HD13 | 2.32 | 0.44 |
| 2:H:138:GLN:HG2 | 2:H:140:ASP:H | 1.83 | 0.44 |
| 2:H:1287:LEU:HD13 | 2:H:1289:LEU:HG | 1.99 | 0.44 |
| 2:K:138:GLN:HG2 | 2:K:140:ASP:H | 1.83 | 0.44 |
| 2:K:355:LEU:HB3 | 2:K:378:LEU:HB3 | 2.00 | 0.44 |
| 2:K:2284:ASN:ND2 | 2:K:2287:LEU:HD13 | 2.32 | 0.44 |
| 2:K:2378:LEU:HD12 | 2:K:2381:ILE:HD11 | 1.98 | 0.44 |
| 2:B:355:LEU:HB3 | 2:B:378:LEU:HB3 | 2.00 | 0.44 |
| 2:B:1287:LEU:HD13 | 2:B:1289:LEU:HG | 1.99 | 0.44 |
| 2:E:3954:LYS:HA | 2:E:4014:LEU:HD13 | 1.99 | 0.44 |
| 2:H:2172:GLY:H | 2:H:2175:GLU:HB2 | 1.83 | 0.44 |
| 2:B:3954:LYS:HA | 2:B:4014:LEU:HD13 | 1.99 | 0.44 |
| 2:E:214:VAL:HG22 | 2:E:341:TYR:CZ | 2.53 | 0.44 |
| 3:I:21:ASP:HB2 | 3:I:28:ILE:HD11 | 2.00 | 0.44 |
| 2:K:892:THR:N | 2:K:902:ARG:O | 2.48 | 0.44 |
| 2:K:2172:GLY:H | 2:K:2175:GLU:HB2 | 1.83 | 0.44 |
| 2:B:35:LEU:HD13 | 2:B:49:LEU:HD13 | 2.00 | 0.44 |
| 2:B:308:HIS:H | 2:B:312:THR:HG21 | 1.83 | 0.44 |
| 2:E:2239:TYR:OH | 3:F:68:GLU:OE2 | 2.33 | 0.44 |
| 2:E:2272:THR:HG23 | 2:E:2275:ASP:H | 1.83 | 0.44 |
| 2:H:214:VAL:HG22 | 2:H:341:TYR:CZ | 2.53 | 0.44 |

Continued on next page...

Continued from previous page...

| Atom-1 | Atom-2 | Interatomic distance (Å) | Clash overlap (Å) |
|-------------------|-------------------|--------------------------|-------------------|
| 2:H:1639:LEU:HD21 | 2:H:1650:ILE:HD13 | 1.99 | 0.44 |
| 2:K:1227:ALA:HB1 | 2:K:1230:MET:HB2 | 2.00 | 0.44 |
| 2:B:682:LEU:HD13 | 2:B:787:VAL:HG11 | 1.99 | 0.43 |
| 2:B:2172:GLY:H | 2:B:2175:GLU:HB2 | 1.83 | 0.43 |
| 2:B:2457:ILE:HG23 | 2:E:131:LEU:HD23 | 2.00 | 0.43 |
| 2:H:308:HIS:H | 2:H:312:THR:HG21 | 1.83 | 0.43 |
| 2:H:1227:ALA:HB1 | 2:H:1230:MET:HB2 | 2.00 | 0.43 |
| 2:K:2272:THR:HG23 | 2:K:2275:ASP:H | 1.83 | 0.43 |
| 2:B:138:GLN:HG2 | 2:B:140:ASP:H | 1.83 | 0.43 |
| 2:E:35:LEU:HD13 | 2:E:49:LEU:HD13 | 2.00 | 0.43 |
| 2:E:682:LEU:HD13 | 2:E:787:VAL:HG11 | 1.99 | 0.43 |
| 2:K:499:THR:HG22 | 2:K:500:ALA:H | 1.81 | 0.43 |
| 2:K:1287:LEU:HD13 | 2:K:1289:LEU:HG | 1.99 | 0.43 |
| 2:B:257:ARG:HA | 2:B:286:THR:HG21 | 1.99 | 0.43 |
| 2:E:257:ARG:HA | 2:E:286:THR:HG21 | 1.99 | 0.43 |
| 2:E:1227:ALA:HB1 | 2:E:1230:MET:HB2 | 2.00 | 0.43 |
| 2:E:1287:LEU:HD13 | 2:E:1289:LEU:HG | 1.99 | 0.43 |
| 3:F:21:ASP:HB2 | 3:F:28:ILE:HD11 | 2.00 | 0.43 |
| 2:H:35:LEU:HD13 | 2:H:49:LEU:HD13 | 2.00 | 0.43 |
| 2:E:2172:GLY:H | 2:E:2175:GLU:HB2 | 1.83 | 0.43 |
| 2:H:355:LEU:HB3 | 2:H:378:LEU:HB3 | 2.00 | 0.43 |
| 2:H:3804:ASN:HB2 | 2:H:3807:VAL:HG12 | 1.98 | 0.43 |
| 2:K:214:VAL:HG22 | 2:K:341:TYR:CZ | 2.53 | 0.43 |
| 2:K:308:HIS:H | 2:K:312:THR:HG21 | 1.83 | 0.43 |
| 2:H:615:ARG:NH2 | 2:H:1677:GLY:O | 2.52 | 0.43 |
| 2:H:1448:VAL:HG22 | 2:H:1554:VAL:HG23 | 2.01 | 0.43 |
| 2:H:2457:ILE:HG23 | 2:K:131:LEU:HD23 | 2.00 | 0.43 |
| 2:K:3954:LYS:HA | 2:K:4014:LEU:HD13 | 1.99 | 0.43 |
| 2:B:615:ARG:NH2 | 2:B:1677:GLY:O | 2.52 | 0.43 |
| 2:B:1639:LEU:HD21 | 2:B:1650:ILE:HD13 | 1.99 | 0.43 |
| 2:E:1639:LEU:HD21 | 2:E:1650:ILE:HD13 | 1.99 | 0.43 |
| 2:K:35:LEU:HD13 | 2:K:49:LEU:HD13 | 2.00 | 0.43 |
| 2:B:1227:ALA:HB1 | 2:B:1230:MET:HB2 | 2.00 | 0.43 |
| 2:B:214:VAL:HG22 | 2:B:341:TYR:CZ | 2.53 | 0.43 |
| 2:B:804:PRO:HA | 2:B:805:PRO:HD3 | 1.96 | 0.43 |
| 2:B:2272:THR:HG23 | 2:B:2275:ASP:H | 1.83 | 0.43 |
| 2:E:138:GLN:HG2 | 2:E:140:ASP:H | 1.83 | 0.43 |
| 2:E:615:ARG:NH2 | 2:E:1677:GLY:O | 2.52 | 0.43 |
| 2:E:1448:VAL:HG22 | 2:E:1554:VAL:HG23 | 2.01 | 0.43 |
| 2:E:2457:ILE:HG23 | 2:H:131:LEU:HD23 | 2.00 | 0.43 |
| 2:H:2272:THR:HG23 | 2:H:2275:ASP:H | 1.83 | 0.43 |

Continued on next page...

Continued from previous page...

| Atom-1 | Atom-2 | Interatomic distance (Å) | Clash overlap (Å) |
|-------------------|-------------------|--------------------------|-------------------|
| 2:K:21:VAL:HB | 2:K:205:ILE:HD11 | 2.01 | 0.43 |
| 2:B:1867:ILE:HG22 | 2:B:1927:LEU:HD23 | 2.01 | 0.43 |
| 2:E:355:LEU:HB3 | 2:E:378:LEU:HB3 | 2.00 | 0.43 |
| 2:B:4016:LYS:HA | 2:B:4134:ILE:HD13 | 2.01 | 0.42 |
| 2:H:21:VAL:HB | 2:H:205:ILE:HD11 | 2.01 | 0.42 |
| 2:K:615:ARG:NH2 | 2:K:1677:GLY:O | 2.52 | 0.42 |
| 2:K:682:LEU:HD13 | 2:K:787:VAL:HG11 | 1.99 | 0.42 |
| 2:E:21:VAL:HB | 2:E:205:ILE:HD11 | 2.01 | 0.42 |
| 2:H:682:LEU:HD13 | 2:H:787:VAL:HG11 | 1.99 | 0.42 |
| 2:K:4016:LYS:HA | 2:K:4134:ILE:HD13 | 2.01 | 0.42 |
| 3:C:21:ASP:HB2 | 3:C:28:ILE:HD11 | 2.00 | 0.42 |
| 2:E:308:HIS:H | 2:E:312:THR:HG21 | 1.83 | 0.42 |
| 2:E:1867:ILE:HG22 | 2:E:1927:LEU:HD23 | 2.01 | 0.42 |
| 2:E:4016:LYS:HA | 2:E:4134:ILE:HD13 | 2.01 | 0.42 |
| 3:F:5:LEU:HD21 | 3:F:74:ALA:HA | 2.01 | 0.42 |
| 2:H:942:ALA:N | 2:H:1050:GLY:O | 2.48 | 0.42 |
| 2:H:1867:ILE:HG22 | 2:H:1927:LEU:HD23 | 2.01 | 0.42 |
| 2:H:3625:ARG:HH11 | 3:I:146:MET:HA | 1.85 | 0.42 |
| 2:K:1247:ALA:HA | 2:K:1598:GLN:HA | 2.01 | 0.42 |
| 2:K:1745:ILE:HD12 | 2:K:1745:ILE:HA | 1.96 | 0.42 |
| 3:L:21:ASP:HB2 | 3:L:28:ILE:HD11 | 2.00 | 0.42 |
| 2:B:1247:ALA:HA | 2:B:1598:GLN:HA | 2.01 | 0.42 |
| 2:B:3625:ARG:HH11 | 3:C:146:MET:HA | 1.85 | 0.42 |
| 3:I:5:LEU:HD21 | 3:I:74:ALA:HA | 2.01 | 0.42 |
| 3:L:33:LEU:HD22 | 3:L:64:ILE:HG12 | 2.02 | 0.42 |
| 2:B:131:LEU:HD23 | 2:K:2457:ILE:HG23 | 2.00 | 0.42 |
| 2:B:1448:VAL:HG22 | 2:B:1554:VAL:HG23 | 2.01 | 0.42 |
| 3:I:33:LEU:HD22 | 3:I:64:ILE:HG12 | 2.02 | 0.42 |
| 2:K:1448:VAL:HG22 | 2:K:1554:VAL:HG23 | 2.01 | 0.42 |
| 2:K:4634:THR:HG22 | 2:K:4636:TYR:H | 1.85 | 0.42 |
| 2:B:4129:GLU:HB3 | 2:B:4130:PRO:HD3 | 2.02 | 0.42 |
| 2:H:49:LEU:HD11 | 2:H:191:VAL:HG13 | 2.02 | 0.42 |
| 2:B:21:VAL:HB | 2:B:205:ILE:HD11 | 2.01 | 0.42 |
| 2:B:942:ALA:N | 2:B:1050:GLY:O | 2.48 | 0.42 |
| 2:B:4634:THR:HG22 | 2:B:4636:TYR:H | 1.85 | 0.42 |
| 2:H:3930:TRP:CD1 | 2:K:80:GLU:HG3 | 2.55 | 0.42 |
| 3:C:5:LEU:HD21 | 3:C:74:ALA:HA | 2.01 | 0.42 |
| 2:K:3625:ARG:HH11 | 3:L:146:MET:HA | 1.85 | 0.42 |
| 2:E:49:LEU:HD11 | 2:E:191:VAL:HG13 | 2.02 | 0.42 |
| 1:J:35:LYS:HD2 | 2:K:636:ASN:HD21 | 1.85 | 0.42 |
| 2:K:1867:ILE:HG22 | 2:K:1927:LEU:HD23 | 2.01 | 0.42 |

Continued on next page...

Continued from previous page...

| Atom-1 | Atom-2 | Interatomic distance (Å) | Clash overlap (Å) |
|-------------------|-------------------|--------------------------|-------------------|
| 2:B:299:LEU:HD23 | 2:B:299:LEU:H | 1.85 | 0.42 |
| 2:B:1465:ASP:OD1 | 2:B:1465:ASP:N | 2.53 | 0.42 |
| 3:C:33:LEU:HD22 | 3:C:64:ILE:HG12 | 2.02 | 0.42 |
| 2:E:1247:ALA:HA | 2:E:1598:GLN:HA | 2.01 | 0.42 |
| 2:E:1526:LEU:HD23 | 2:E:1526:LEU:H | 1.85 | 0.42 |
| 2:E:4129:GLU:HB3 | 2:E:4130:PRO:HD3 | 2.02 | 0.42 |
| 2:H:1686:CYS:HB3 | 2:H:1783:PHE:HZ | 1.85 | 0.42 |
| 2:H:4016:LYS:HA | 2:H:4134:ILE:HD13 | 2.01 | 0.42 |
| 2:K:1686:CYS:HB3 | 2:K:1783:PHE:HZ | 1.85 | 0.42 |
| 3:L:5:LEU:HD21 | 3:L:74:ALA:HA | 2.01 | 0.42 |
| 2:B:80:GLU:HG3 | 2:K:3930:TRP:CD1 | 2.55 | 0.41 |
| 2:E:181:HIS:ND1 | 2:E:182:LEU:O | 2.53 | 0.41 |
| 1:G:35:LYS:HD2 | 2:H:636:ASN:HD21 | 1.85 | 0.41 |
| 2:K:4031:VAL:HG13 | 2:K:4148:HIS:HA | 2.02 | 0.41 |
| 2:B:3930:TRP:CD1 | 2:E:80:GLU:HG3 | 2.55 | 0.41 |
| 1:D:35:LYS:HD2 | 2:E:636:ASN:HD21 | 1.85 | 0.41 |
| 2:E:1686:CYS:HB3 | 2:E:1783:PHE:HZ | 1.85 | 0.41 |
| 2:E:3625:ARG:HH11 | 3:F:146:MET:HA | 1.85 | 0.41 |
| 2:H:4031:VAL:HG13 | 2:H:4148:HIS:HA | 2.02 | 0.41 |
| 2:B:1857:ASP:N | 2:B:1857:ASP:OD1 | 2.53 | 0.41 |
| 2:E:35:LEU:HD11 | 2:E:189:LEU:HD13 | 2.02 | 0.41 |
| 2:E:2243:ILE:HA | 3:F:2:ALA:HB3 | 2.03 | 0.41 |
| 2:E:3936:ASP:OD1 | 2:E:3936:ASP:N | 2.53 | 0.41 |
| 3:F:33:LEU:HD22 | 3:F:64:ILE:HG12 | 2.02 | 0.41 |
| 2:H:4634:THR:HG22 | 2:H:4636:TYR:H | 1.85 | 0.41 |
| 2:K:49:LEU:HD11 | 2:K:191:VAL:HG13 | 2.02 | 0.41 |
| 2:K:1526:LEU:HD23 | 2:K:1526:LEU:H | 1.85 | 0.41 |
| 2:B:1686:CYS:HB3 | 2:B:1783:PHE:HZ | 1.85 | 0.41 |
| 2:B:2243:ILE:HA | 3:C:2:ALA:HB3 | 2.03 | 0.41 |
| 2:B:2455:ARG:HE | 2:B:2459:ARG:HH22 | 1.68 | 0.41 |
| 2:E:2455:ARG:HE | 2:E:2459:ARG:HH22 | 1.68 | 0.41 |
| 2:H:684:VAL:HG22 | 2:H:781:VAL:HG23 | 2.02 | 0.41 |
| 2:H:1745:ILE:HD12 | 2:H:1745:ILE:HA | 1.96 | 0.41 |
| 2:K:181:HIS:ND1 | 2:K:182:LEU:O | 2.53 | 0.41 |
| 2:K:1465:ASP:OD1 | 2:K:1465:ASP:N | 2.53 | 0.41 |
| 2:E:684:VAL:HG22 | 2:E:781:VAL:HG23 | 2.02 | 0.41 |
| 2:E:3930:TRP:CD1 | 2:H:80:GLU:HG3 | 2.55 | 0.41 |
| 2:H:1247:ALA:HA | 2:H:1598:GLN:HA | 2.01 | 0.41 |
| 2:H:1465:ASP:OD1 | 2:H:1465:ASP:N | 2.53 | 0.41 |
| 2:H:1526:LEU:HD23 | 2:H:1526:LEU:H | 1.85 | 0.41 |
| 2:K:4129:GLU:HB3 | 2:K:4130:PRO:HD3 | 2.02 | 0.41 |

Continued on next page...

Continued from previous page...

| Atom-1 | Atom-2 | Interatomic distance (Å) | Clash overlap (Å) |
|-------------------|-------------------|--------------------------|-------------------|
| 2:B:4031:VAL:HG13 | 2:B:4148:HIS:HA | 2.02 | 0.41 |
| 2:B:4700:ASP:HA | 2:B:4776:TRP:HE1 | 1.86 | 0.41 |
| 2:E:4700:ASP:HA | 2:E:4776:TRP:HE1 | 1.86 | 0.41 |
| 2:B:1526:LEU:H | 2:B:1526:LEU:HD23 | 1.85 | 0.41 |
| 2:E:1465:ASP:N | 2:E:1465:ASP:OD1 | 2.53 | 0.41 |
| 2:K:1600:LEU:HD23 | 2:K:1600:LEU:HA | 1.96 | 0.41 |
| 2:K:2455:ARG:HE | 2:K:2459:ARG:HH22 | 1.68 | 0.41 |
| 2:B:49:LEU:HD11 | 2:B:191:VAL:HG13 | 2.02 | 0.41 |
| 2:B:167:ASP:N | 2:B:167:ASP:OD1 | 2.50 | 0.41 |
| 2:B:687:ALA:HA | 2:B:713:SER:HA | 2.03 | 0.41 |
| 2:B:3936:ASP:N | 2:B:3936:ASP:OD1 | 2.53 | 0.41 |
| 2:E:143:GLY:HA2 | 2:E:147:TRP:HE1 | 1.86 | 0.41 |
| 2:E:1857:ASP:N | 2:E:1857:ASP:OD1 | 2.53 | 0.41 |
| 2:H:143:GLY:HA2 | 2:H:147:TRP:HE1 | 1.86 | 0.41 |
| 2:H:687:ALA:HA | 2:H:713:SER:HA | 2.03 | 0.41 |
| 2:H:4129:GLU:HB3 | 2:H:4130:PRO:HD3 | 2.02 | 0.41 |
| 2:K:299:LEU:HD23 | 2:K:299:LEU:H | 1.85 | 0.41 |
| 2:H:1857:ASP:OD1 | 2:H:1857:ASP:N | 2.53 | 0.41 |
| 2:K:2258:LEU:HD13 | 2:K:2276:VAL:HG13 | 2.03 | 0.41 |
| 3:L:17:PHE:CE1 | 3:L:28:ILE:HD12 | 2.57 | 0.41 |
| 1:A:35:LYS:HD2 | 2:B:636:ASN:HD21 | 1.85 | 0.40 |
| 2:B:35:LEU:HD11 | 2:B:189:LEU:HD13 | 2.02 | 0.40 |
| 2:B:1101:ARG:HB3 | 2:B:1123:VAL:HG21 | 2.04 | 0.40 |
| 2:E:663:TYR:HD1 | 2:E:747:CYS:HB3 | 1.86 | 0.40 |
| 2:H:1499:ASP:OD1 | 2:H:1499:ASP:N | 2.55 | 0.40 |
| 2:K:143:GLY:HA2 | 2:K:147:TRP:HE1 | 1.86 | 0.40 |
| 2:K:638:ILE:HD12 | 2:K:1638:ALA:HB3 | 2.03 | 0.40 |
| 2:K:684:VAL:HG22 | 2:K:781:VAL:HG23 | 2.02 | 0.40 |
| 2:K:1101:ARG:HB3 | 2:K:1123:VAL:HG21 | 2.04 | 0.40 |
| 2:K:1857:ASP:OD1 | 2:K:1857:ASP:N | 2.53 | 0.40 |
| 2:K:4700:ASP:HA | 2:K:4776:TRP:HE1 | 1.86 | 0.40 |
| 2:B:638:ILE:HD12 | 2:B:1638:ALA:HB3 | 2.03 | 0.40 |
| 2:B:663:TYR:HD1 | 2:B:747:CYS:HB3 | 1.86 | 0.40 |
| 2:E:687:ALA:HA | 2:E:713:SER:HA | 2.03 | 0.40 |
| 2:E:4634:THR:HG22 | 2:E:4636:TYR:H | 1.85 | 0.40 |
| 2:H:288:GLY:HA3 | 2:H:405:TYR:CZ | 2.56 | 0.40 |
| 2:H:299:LEU:HD23 | 2:H:299:LEU:H | 1.85 | 0.40 |
| 2:H:609:CYS:HB3 | 2:H:612:VAL:O | 2.22 | 0.40 |
| 2:K:35:LEU:HD11 | 2:K:189:LEU:HD13 | 2.02 | 0.40 |
| 2:B:143:GLY:HA2 | 2:B:147:TRP:HE1 | 1.86 | 0.40 |
| 2:B:684:VAL:HG22 | 2:B:781:VAL:HG23 | 2.02 | 0.40 |

Continued on next page...

Continued from previous page...

| Atom-1 | Atom-2 | Interatomic distance (Å) | Clash overlap (Å) |
|-------------------|-------------------|--------------------------|-------------------|
| 2:E:3905:THR:HG23 | 2:E:3906:THR:HG23 | 2.04 | 0.40 |
| 2:H:181:HIS:ND1 | 2:H:182:LEU:O | 2.53 | 0.40 |
| 2:H:1777:HIS:HB3 | 2:H:1799:LEU:HD13 | 2.04 | 0.40 |
| 2:H:1834:SER:HB2 | 2:H:1837:PHE:HD1 | 1.87 | 0.40 |
| 2:H:2455:ARG:HE | 2:H:2459:ARG:HH22 | 1.68 | 0.40 |
| 2:K:288:GLY:HA3 | 2:K:405:TYR:CZ | 2.56 | 0.40 |
| 2:K:2284:ASN:HD21 | 2:K:2287:LEU:HD13 | 1.87 | 0.40 |
| 2:B:2258:LEU:HD13 | 2:B:2276:VAL:HG13 | 2.03 | 0.40 |
| 2:H:2243:ILE:HA | 3:I:2:ALA:HB3 | 2.03 | 0.40 |
| 2:H:3622:LYS:C | 2:H:3624:ARG:H | 2.25 | 0.40 |
| 2:K:687:ALA:HA | 2:K:713:SER:HA | 2.03 | 0.40 |
| 2:K:3936:ASP:N | 2:K:3936:ASP:OD1 | 2.53 | 0.40 |
| 2:B:288:GLY:HA3 | 2:B:405:TYR:CZ | 2.56 | 0.40 |
| 2:B:336:PRO:HA | 2:B:337:PRO:HD3 | 1.89 | 0.40 |
| 3:C:17:PHE:CE1 | 3:C:28:ILE:HD12 | 2.57 | 0.40 |
| 2:E:609:CYS:HB3 | 2:E:612:VAL:O | 2.22 | 0.40 |
| 2:E:2258:LEU:HD13 | 2:E:2276:VAL:HG13 | 2.03 | 0.40 |
| 2:E:4031:VAL:HG13 | 2:E:4148:HIS:HA | 2.02 | 0.40 |
| 3:F:17:PHE:CE1 | 3:F:28:ILE:HD12 | 2.57 | 0.40 |
| 2:H:4700:ASP:HA | 2:H:4776:TRP:HE1 | 1.86 | 0.40 |
| 2:K:2243:ILE:HA | 3:L:2:ALA:HB3 | 2.03 | 0.40 |

There are no symmetry-related clashes.

5.3 Torsion angles [\(i\)](#)

5.3.1 Protein backbone [\(i\)](#)

In the following table, the Percentiles column shows the percent Ramachandran outliers of the chain as a percentile score with respect to all PDB entries followed by that with respect to all EM entries.

The Analysed column shows the number of residues for which the backbone conformation was analysed, and the total number of residues.

| Mol | Chain | Analysed | Favoured | Allowed | Outliers | Percentiles | |
|-----|-------|---------------|----------|---------|----------|-------------|-----|
| 1 | A | 104/107 (97%) | 98 (94%) | 6 (6%) | 0 | 100 | 100 |
| 1 | D | 104/107 (97%) | 98 (94%) | 6 (6%) | 0 | 100 | 100 |
| 1 | G | 104/107 (97%) | 98 (94%) | 6 (6%) | 0 | 100 | 100 |
| 1 | J | 104/107 (97%) | 98 (94%) | 6 (6%) | 0 | 100 | 100 |

Continued on next page...

Continued from previous page...

| Mol | Chain | Analysed | Favoured | Allowed | Outliers | Percentiles | |
|-----|-------|-------------------|-------------|----------|----------|-------------|-----|
| 2 | B | 3396/3816 (89%) | 3335 (98%) | 61 (2%) | 0 | 100 | 100 |
| 2 | E | 3396/3816 (89%) | 3335 (98%) | 61 (2%) | 0 | 100 | 100 |
| 2 | H | 3396/3816 (89%) | 3335 (98%) | 61 (2%) | 0 | 100 | 100 |
| 2 | K | 3396/3816 (89%) | 3335 (98%) | 61 (2%) | 0 | 100 | 100 |
| 3 | C | 127/148 (86%) | 124 (98%) | 3 (2%) | 0 | 100 | 100 |
| 3 | F | 127/148 (86%) | 124 (98%) | 3 (2%) | 0 | 100 | 100 |
| 3 | I | 127/148 (86%) | 124 (98%) | 3 (2%) | 0 | 100 | 100 |
| 3 | L | 127/148 (86%) | 124 (98%) | 3 (2%) | 0 | 100 | 100 |
| All | All | 14508/16284 (89%) | 14228 (98%) | 280 (2%) | 0 | 100 | 100 |

There are no Ramachandran outliers to report.

5.3.2 Protein sidechains [i](#)

In the following table, the Percentiles column shows the percent sidechain outliers of the chain as a percentile score with respect to all PDB entries followed by that with respect to all EM entries.

The Analysed column shows the number of residues for which the sidechain conformation was analysed, and the total number of residues.

| Mol | Chain | Analysed | Rotameric | Outliers | Percentiles | |
|-----|-------|------------------|-------------|----------|-------------|-----|
| 1 | A | 66/88 (75%) | 66 (100%) | 0 | 100 | 100 |
| 1 | D | 66/88 (75%) | 66 (100%) | 0 | 100 | 100 |
| 1 | G | 66/88 (75%) | 66 (100%) | 0 | 100 | 100 |
| 1 | J | 66/88 (75%) | 66 (100%) | 0 | 100 | 100 |
| 2 | B | 2222/3025 (74%) | 2221 (100%) | 1 (0%) | 100 | 100 |
| 2 | E | 2222/3025 (74%) | 2221 (100%) | 1 (0%) | 100 | 100 |
| 2 | H | 2222/3025 (74%) | 2221 (100%) | 1 (0%) | 100 | 100 |
| 2 | K | 2222/3025 (74%) | 2221 (100%) | 1 (0%) | 100 | 100 |
| 3 | C | 29/126 (23%) | 29 (100%) | 0 | 100 | 100 |
| 3 | F | 29/126 (23%) | 29 (100%) | 0 | 100 | 100 |
| 3 | I | 29/126 (23%) | 29 (100%) | 0 | 100 | 100 |
| 3 | L | 29/126 (23%) | 29 (100%) | 0 | 100 | 100 |
| All | All | 9268/12956 (72%) | 9264 (100%) | 4 (0%) | 100 | 100 |

All (4) residues with a non-rotameric sidechain are listed below:

| Mol | Chain | Res | Type |
|-----|-------|------|------|
| 2 | B | 2128 | GLN |
| 2 | E | 2128 | GLN |
| 2 | H | 2128 | GLN |
| 2 | K | 2128 | GLN |

Sometimes sidechains can be flipped to improve hydrogen bonding and reduce clashes. All (16) such sidechains are listed below:

| Mol | Chain | Res | Type |
|-----|-------|------|------|
| 2 | B | 838 | HIS |
| 2 | B | 2128 | GLN |
| 2 | B | 3955 | GLN |
| 2 | B | 4976 | HIS |
| 2 | E | 838 | HIS |
| 2 | E | 2128 | GLN |
| 2 | E | 3955 | GLN |
| 2 | E | 4981 | HIS |
| 2 | H | 838 | HIS |
| 2 | H | 2128 | GLN |
| 2 | H | 3955 | GLN |
| 2 | H | 4981 | HIS |
| 2 | K | 838 | HIS |
| 2 | K | 2128 | GLN |
| 2 | K | 3955 | GLN |
| 2 | K | 4981 | HIS |

5.3.3 RNA [i](#)

There are no RNA molecules in this entry.

5.4 Non-standard residues in protein, DNA, RNA chains [i](#)

There are no non-standard protein/DNA/RNA residues in this entry.

5.5 Carbohydrates [i](#)

There are no oligosaccharides in this entry.

5.6 Ligand geometry [i](#)

Of 4 ligands modelled in this entry, 4 are monoatomic - leaving 0 for Mogul analysis.

There are no bond length outliers.

There are no bond angle outliers.

There are no chirality outliers.

There are no torsion outliers.

There are no ring outliers.

No monomer is involved in short contacts.

5.7 Other polymers [i](#)

There are no such residues in this entry.

5.8 Polymer linkage issues [i](#)

The following chains have linkage breaks:

| Mol | Chain | Number of breaks |
|-----|-------|------------------|
| 2 | B | 56 |
| 2 | E | 56 |
| 2 | H | 56 |
| 2 | K | 56 |

All chain breaks are listed below:

| Model | Chain | Residue-1 | Atom-1 | Residue-2 | Atom-2 | Distance (Å) |
|-------|-------|-----------|--------|-----------|--------|--------------|
| 1 | B | 4331:UNK | C | 4543:GLU | N | 51.24 |
| 1 | E | 4331:UNK | C | 4543:GLU | N | 51.24 |
| 1 | H | 4331:UNK | C | 4543:GLU | N | 51.24 |
| 1 | K | 4331:UNK | C | 4543:GLU | N | 51.24 |
| 1 | B | 1054:GLU | C | 1071:ARG | N | 36.98 |
| 1 | E | 1054:GLU | C | 1071:ARG | N | 36.98 |
| 1 | H | 1054:GLU | C | 1071:ARG | N | 36.98 |
| 1 | K | 1054:GLU | C | 1071:ARG | N | 36.98 |
| 1 | B | 854:CYS | C | 866:HIS | N | 29.09 |
| 1 | E | 854:CYS | C | 866:HIS | N | 29.09 |
| 1 | H | 854:CYS | C | 866:HIS | N | 29.09 |
| 1 | K | 854:CYS | C | 866:HIS | N | 29.09 |
| 1 | B | 3606:UNK | C | 3617:HIS | N | 28.52 |

Continued on next page...

Continued from previous page...

| Model | Chain | Residue-1 | Atom-1 | Residue-2 | Atom-2 | Distance (Å) |
|-------|-------|-----------|--------|-----------|--------|--------------|
| 1 | E | 3606:UNK | C | 3617:HIS | N | 28.52 |
| 1 | H | 3606:UNK | C | 3617:HIS | N | 28.52 |
| 1 | K | 3606:UNK | C | 3617:HIS | N | 28.52 |
| 1 | B | 4245:GLN | C | 4315:UNK | N | 27.59 |
| 1 | E | 4245:GLN | C | 4315:UNK | N | 27.59 |
| 1 | H | 4245:GLN | C | 4315:UNK | N | 27.59 |
| 1 | K | 4245:GLN | C | 4315:UNK | N | 27.59 |
| 1 | B | 2700:UNK | C | 2736:ASP | N | 25.87 |
| 1 | E | 2700:UNK | C | 2736:ASP | N | 25.87 |
| 1 | H | 2700:UNK | C | 2736:ASP | N | 25.87 |
| 1 | K | 2700:UNK | C | 2736:ASP | N | 25.87 |
| 1 | B | 2830:GLU | C | 2855:TYR | N | 23.98 |
| 1 | E | 2830:GLU | C | 2855:TYR | N | 23.98 |
| 1 | H | 2830:GLU | C | 2855:TYR | N | 23.98 |
| 1 | K | 2830:GLU | C | 2855:TYR | N | 23.98 |
| 1 | B | 84:ASN | C | 97:GLY | N | 23.34 |
| 1 | E | 84:ASN | C | 97:GLY | N | 23.34 |
| 1 | H | 84:ASN | C | 97:GLY | N | 23.34 |
| 1 | K | 84:ASN | C | 97:GLY | N | 23.34 |
| 1 | B | 2939:ARG | C | 2956:UNK | N | 23.02 |
| 1 | E | 2939:ARG | C | 2956:UNK | N | 23.02 |
| 1 | H | 2939:ARG | C | 2956:UNK | N | 23.02 |
| 1 | K | 2939:ARG | C | 2956:UNK | N | 23.02 |
| 1 | B | 3555:UNK | C | 3565:UNK | N | 22.27 |
| 1 | E | 3555:UNK | C | 3565:UNK | N | 22.27 |
| 1 | H | 3555:UNK | C | 3565:UNK | N | 22.27 |
| 1 | K | 3555:UNK | C | 3565:UNK | N | 22.27 |
| 1 | B | 1299:GLN | C | 1428:LEU | N | 21.92 |
| 1 | E | 1299:GLN | C | 1428:LEU | N | 21.92 |
| 1 | H | 1299:GLN | C | 1428:LEU | N | 21.92 |
| 1 | K | 1299:GLN | C | 1428:LEU | N | 21.92 |
| 1 | B | 3574:UNK | C | 3586:UNK | N | 21.88 |
| 1 | E | 3574:UNK | C | 3586:UNK | N | 21.88 |
| 1 | H | 3574:UNK | C | 3586:UNK | N | 21.88 |
| 1 | K | 3574:UNK | C | 3586:UNK | N | 21.88 |
| 1 | B | 4737:GLU | C | 4769:ILE | N | 20.65 |
| 1 | E | 4737:GLU | C | 4769:ILE | N | 20.65 |
| 1 | H | 4737:GLU | C | 4769:ILE | N | 20.65 |
| 1 | K | 4737:GLU | C | 4769:ILE | N | 20.65 |
| 1 | B | 2385:ILE | C | 2418:HIS | N | 18.54 |
| 1 | E | 2385:ILE | C | 2418:HIS | N | 18.54 |
| 1 | H | 2385:ILE | C | 2418:HIS | N | 18.54 |

Continued on next page...

Continued from previous page...

| Model | Chain | Residue-1 | Atom-1 | Residue-2 | Atom-2 | Distance (Å) |
|-------|-------|-----------|--------|-----------|--------|--------------|
| 1 | K | 2385:ILE | C | 2418:HIS | N | 18.54 |
| 1 | B | 3358:UNK | C | 3365:UNK | N | 17.90 |
| 1 | E | 3358:UNK | C | 3365:UNK | N | 17.90 |
| 1 | H | 3358:UNK | C | 3365:UNK | N | 17.90 |
| 1 | K | 3358:UNK | C | 3365:UNK | N | 17.90 |
| 1 | B | 2046:GLN | C | 2092:LEU | N | 17.87 |
| 1 | E | 2046:GLN | C | 2092:LEU | N | 17.87 |
| 1 | H | 2046:GLN | C | 2092:LEU | N | 17.87 |
| 1 | K | 2046:GLN | C | 2092:LEU | N | 17.87 |
| 1 | B | 2653:UNK | C | 2664:UNK | N | 17.50 |
| 1 | E | 2653:UNK | C | 2664:UNK | N | 17.50 |
| 1 | H | 2653:UNK | C | 2664:UNK | N | 17.50 |
| 1 | K | 2653:UNK | C | 2664:UNK | N | 17.50 |
| 1 | B | 3193:UNK | C | 3202:UNK | N | 17.22 |
| 1 | E | 3193:UNK | C | 3202:UNK | N | 17.22 |
| 1 | H | 3193:UNK | C | 3202:UNK | N | 17.22 |
| 1 | K | 3193:UNK | C | 3202:UNK | N | 17.22 |
| 1 | B | 3733:GLU | C | 3747:SER | N | 15.80 |
| 1 | E | 3733:GLU | C | 3747:SER | N | 15.80 |
| 1 | H | 3733:GLU | C | 3747:SER | N | 15.80 |
| 1 | K | 3733:GLU | C | 3747:SER | N | 15.80 |
| 1 | B | 3385:UNK | C | 3399:PHE | N | 15.58 |
| 1 | E | 3385:UNK | C | 3399:PHE | N | 15.58 |
| 1 | H | 3385:UNK | C | 3399:PHE | N | 15.58 |
| 1 | K | 3385:UNK | C | 3399:PHE | N | 15.58 |
| 1 | B | 3062:UNK | C | 3146:UNK | N | 15.38 |
| 1 | E | 3062:UNK | C | 3146:UNK | N | 15.38 |
| 1 | H | 3062:UNK | C | 3146:UNK | N | 15.38 |
| 1 | K | 3062:UNK | C | 3146:UNK | N | 15.38 |
| 1 | B | 3238:UNK | C | 3278:UNK | N | 14.98 |
| 1 | E | 3238:UNK | C | 3278:UNK | N | 14.98 |
| 1 | H | 3238:UNK | C | 3278:UNK | N | 14.98 |
| 1 | K | 3238:UNK | C | 3278:UNK | N | 14.98 |
| 1 | B | 2978:UNK | C | 2999:UNK | N | 14.76 |
| 1 | E | 2978:UNK | C | 2999:UNK | N | 14.76 |
| 1 | H | 2978:UNK | C | 2999:UNK | N | 14.76 |
| 1 | K | 2978:UNK | C | 2999:UNK | N | 14.76 |
| 1 | B | 3461:VAL | C | 3509:UNK | N | 13.70 |
| 1 | E | 3461:VAL | C | 3509:UNK | N | 13.70 |
| 1 | H | 3461:VAL | C | 3509:UNK | N | 13.70 |
| 1 | K | 3461:VAL | C | 3509:UNK | N | 13.70 |
| 1 | B | 3018:UNK | C | 3032:UNK | N | 12.78 |

Continued on next page...

Continued from previous page...

| Model | Chain | Residue-1 | Atom-1 | Residue-2 | Atom-2 | Distance (Å) |
|-------|-------|-----------|--------|-----------|--------|--------------|
| 1 | E | 3018:UNK | C | 3032:UNK | N | 12.78 |
| 1 | H | 3018:UNK | C | 3032:UNK | N | 12.78 |
| 1 | K | 3018:UNK | C | 3032:UNK | N | 12.78 |
| 1 | B | 2014:LYS | C | 2023:PRO | N | 12.65 |
| 1 | E | 2014:LYS | C | 2023:PRO | N | 12.65 |
| 1 | H | 2014:LYS | C | 2023:PRO | N | 12.65 |
| 1 | K | 2014:LYS | C | 2023:PRO | N | 12.65 |
| 1 | B | 2683:UNK | C | 2688:UNK | N | 12.62 |
| 1 | E | 2683:UNK | C | 2688:UNK | N | 12.62 |
| 1 | H | 2683:UNK | C | 2688:UNK | N | 12.62 |
| 1 | K | 2683:UNK | C | 2688:UNK | N | 12.62 |
| 1 | B | 2571:ALA | C | 2579:MET | N | 12.58 |
| 1 | E | 2571:ALA | C | 2579:MET | N | 12.58 |
| 1 | H | 2571:ALA | C | 2579:MET | N | 12.58 |
| 1 | K | 2571:ALA | C | 2579:MET | N | 12.58 |
| 1 | B | 3166:UNK | C | 3173:UNK | N | 12.43 |
| 1 | E | 3166:UNK | C | 3173:UNK | N | 12.43 |
| 1 | H | 3166:UNK | C | 3173:UNK | N | 12.43 |
| 1 | K | 3166:UNK | C | 3173:UNK | N | 12.43 |
| 1 | B | 3308:UNK | C | 3320:UNK | N | 12.24 |
| 1 | E | 3308:UNK | C | 3320:UNK | N | 12.24 |
| 1 | H | 3308:UNK | C | 3320:UNK | N | 12.24 |
| 1 | K | 3308:UNK | C | 3320:UNK | N | 12.24 |
| 1 | B | 361:ALA | C | 372:LEU | N | 12.09 |
| 1 | E | 361:ALA | C | 372:LEU | N | 12.09 |
| 1 | H | 361:ALA | C | 372:LEU | N | 12.09 |
| 1 | K | 361:ALA | C | 372:LEU | N | 12.09 |
| 1 | B | 2629:PHE | C | 2641:UNK | N | 12.03 |
| 1 | E | 2629:PHE | C | 2641:UNK | N | 12.03 |
| 1 | H | 2629:PHE | C | 2641:UNK | N | 12.03 |
| 1 | K | 2629:PHE | C | 2641:UNK | N | 12.03 |
| 1 | B | 4090:LYS | C | 4109:UNK | N | 11.95 |
| 1 | E | 4090:LYS | C | 4109:UNK | N | 11.95 |
| 1 | H | 4090:LYS | C | 4109:UNK | N | 11.95 |
| 1 | K | 4090:LYS | C | 4109:UNK | N | 11.95 |
| 1 | B | 1750:PRO | C | 1760:ARG | N | 11.65 |
| 1 | E | 1750:PRO | C | 1760:ARG | N | 11.65 |
| 1 | H | 1750:PRO | C | 1760:ARG | N | 11.65 |
| 1 | K | 1750:PRO | C | 1760:ARG | N | 11.65 |
| 1 | B | 3544:UNK | C | 3548:UNK | N | 11.53 |
| 1 | E | 3544:UNK | C | 3548:UNK | N | 11.53 |
| 1 | H | 3544:UNK | C | 3548:UNK | N | 11.53 |

Continued on next page...

Continued from previous page...

| Model | Chain | Residue-1 | Atom-1 | Residue-2 | Atom-2 | Distance (Å) |
|-------|-------|-----------|--------|-----------|--------|--------------|
| 1 | K | 3544:UNK | C | 3548:UNK | N | 11.53 |
| 1 | B | 3217:UNK | C | 3225:UNK | N | 11.39 |
| 1 | E | 3217:UNK | C | 3225:UNK | N | 11.39 |
| 1 | H | 3217:UNK | C | 3225:UNK | N | 11.39 |
| 1 | K | 3217:UNK | C | 3225:UNK | N | 11.39 |
| 1 | B | 1501:VAL | C | 1510:SER | N | 11.35 |
| 1 | E | 1501:VAL | C | 1510:SER | N | 11.35 |
| 1 | H | 1501:VAL | C | 1510:SER | N | 11.35 |
| 1 | K | 1501:VAL | C | 1510:SER | N | 11.35 |
| 1 | B | 3047:UNK | C | 3051:UNK | N | 11.02 |
| 1 | E | 3047:UNK | C | 3051:UNK | N | 11.02 |
| 1 | H | 3047:UNK | C | 3051:UNK | N | 11.02 |
| 1 | K | 3047:UNK | C | 3051:UNK | N | 11.02 |
| 1 | B | 1788:PRO | C | 1794:GLU | N | 10.90 |
| 1 | E | 1788:PRO | C | 1794:GLU | N | 10.90 |
| 1 | H | 1788:PRO | C | 1794:GLU | N | 10.90 |
| 1 | K | 1788:PRO | C | 1794:GLU | N | 10.90 |
| 1 | B | 4114:UNK | C | 4122:GLU | N | 10.72 |
| 1 | E | 4114:UNK | C | 4122:GLU | N | 10.72 |
| 1 | H | 4114:UNK | C | 4122:GLU | N | 10.72 |
| 1 | K | 4114:UNK | C | 4122:GLU | N | 10.72 |
| 1 | B | 1871:VAL | C | 1924:GLU | N | 10.67 |
| 1 | E | 1871:VAL | C | 1924:GLU | N | 10.67 |
| 1 | H | 1871:VAL | C | 1924:GLU | N | 10.67 |
| 1 | K | 1871:VAL | C | 1924:GLU | N | 10.67 |
| 1 | B | 3335:UNK | C | 3346:UNK | N | 10.58 |
| 1 | E | 3335:UNK | C | 3346:UNK | N | 10.58 |
| 1 | H | 3335:UNK | C | 3346:UNK | N | 10.58 |
| 1 | K | 3335:UNK | C | 3346:UNK | N | 10.58 |
| 1 | B | 3288:UNK | C | 3292:UNK | N | 10.44 |
| 1 | E | 3288:UNK | C | 3292:UNK | N | 10.44 |
| 1 | H | 3288:UNK | C | 3292:UNK | N | 10.44 |
| 1 | K | 3288:UNK | C | 3292:UNK | N | 10.44 |
| 1 | B | 323:LEU | C | 328:LYS | N | 10.40 |
| 1 | E | 323:LEU | C | 328:LYS | N | 10.40 |
| 1 | H | 323:LEU | C | 328:LYS | N | 10.40 |
| 1 | K | 323:LEU | C | 328:LYS | N | 10.40 |
| 1 | B | 4585:PRO | C | 4626:VAL | N | 10.08 |
| 1 | E | 4585:PRO | C | 4626:VAL | N | 10.08 |
| 1 | H | 4585:PRO | C | 4626:VAL | N | 10.08 |
| 1 | K | 4585:PRO | C | 4626:VAL | N | 10.08 |
| 1 | B | 2535:ALA | C | 2549:LEU | N | 9.70 |

Continued on next page...

Continued from previous page...

| Model | Chain | Residue-1 | Atom-1 | Residue-2 | Atom-2 | Distance (Å) |
|-------|-------|-----------|--------|-----------|--------|--------------|
| 1 | E | 2535:ALA | C | 2549:LEU | N | 9.70 |
| 1 | H | 2535:ALA | C | 2549:LEU | N | 9.70 |
| 1 | K | 2535:ALA | C | 2549:LEU | N | 9.70 |
| 1 | B | 2478:PRO | C | 2491:MET | N | 9.63 |
| 1 | E | 2478:PRO | C | 2491:MET | N | 9.63 |
| 1 | H | 2478:PRO | C | 2491:MET | N | 9.63 |
| 1 | K | 2478:PRO | C | 2491:MET | N | 9.63 |
| 1 | B | 3526:UNK | C | 3534:UNK | N | 9.43 |
| 1 | E | 3526:UNK | C | 3534:UNK | N | 9.43 |
| 1 | H | 3526:UNK | C | 3534:UNK | N | 9.43 |
| 1 | K | 3526:UNK | C | 3534:UNK | N | 9.43 |
| 1 | B | 2263:GLY | C | 2267:GLY | N | 8.79 |
| 1 | E | 2263:GLY | C | 2267:GLY | N | 8.79 |
| 1 | H | 2263:GLY | C | 2267:GLY | N | 8.79 |
| 1 | K | 2263:GLY | C | 2267:GLY | N | 8.79 |
| 1 | B | 3861:ILE | C | 3866:GLY | N | 8.58 |
| 1 | E | 3861:ILE | C | 3866:GLY | N | 8.58 |
| 1 | H | 3861:ILE | C | 3866:GLY | N | 8.58 |
| 1 | K | 3861:ILE | C | 3866:GLY | N | 8.58 |
| 1 | B | 2216:LEU | C | 2225:ARG | N | 7.09 |
| 1 | E | 2216:LEU | C | 2225:ARG | N | 7.09 |
| 1 | H | 2216:LEU | C | 2225:ARG | N | 7.09 |
| 1 | K | 2216:LEU | C | 2225:ARG | N | 7.09 |
| 1 | B | 4219:GLU | C | 4225:LYS | N | 6.52 |
| 1 | E | 4219:GLU | C | 4225:LYS | N | 6.52 |
| 1 | H | 4219:GLU | C | 4225:LYS | N | 6.52 |
| 1 | K | 4219:GLU | C | 4225:LYS | N | 6.52 |
| 1 | B | 1275:ARG | C | 1282:SER | N | 6.22 |
| 1 | E | 1275:ARG | C | 1282:SER | N | 6.22 |
| 1 | H | 1275:ARG | C | 1282:SER | N | 6.22 |
| 1 | K | 1275:ARG | C | 1282:SER | N | 6.22 |
| 1 | B | 4863:LYS | C | 4872:MET | N | 5.66 |
| 1 | E | 4863:LYS | C | 4872:MET | N | 5.66 |
| 1 | H | 4863:LYS | C | 4872:MET | N | 5.66 |
| 1 | K | 4863:LYS | C | 4872:MET | N | 5.66 |
| 1 | B | 1478:ASP | C | 1482:ASN | N | 5.62 |
| 1 | E | 1478:ASP | C | 1482:ASN | N | 5.62 |
| 1 | H | 1478:ASP | C | 1482:ASN | N | 5.62 |
| 1 | K | 1478:ASP | C | 1482:ASN | N | 5.62 |
| 1 | B | 2527:PHE | C | 2528:LEU | N | 3.17 |
| 1 | E | 2527:PHE | C | 2528:LEU | N | 3.17 |
| 1 | H | 2527:PHE | C | 2528:LEU | N | 3.17 |

Continued on next page...

Continued from previous page...

| Model | Chain | Residue-1 | Atom-1 | Residue-2 | Atom-2 | Distance (Å) |
|-------|-------|-----------|--------|-----------|--------|--------------|
| 1 | K | 2527:PHE | C | 2528:LEU | N | 3.17 |

6 Map visualisation [i](#)

This section contains visualisations of the EMDB entry EMD-22016. These allow visual inspection of the internal detail of the map and identification of artifacts.

No raw map or half-maps were deposited for this entry and therefore no images, graphs, etc. pertaining to the raw map can be shown.

6.1 Orthogonal projections [i](#)

6.1.1 Primary map

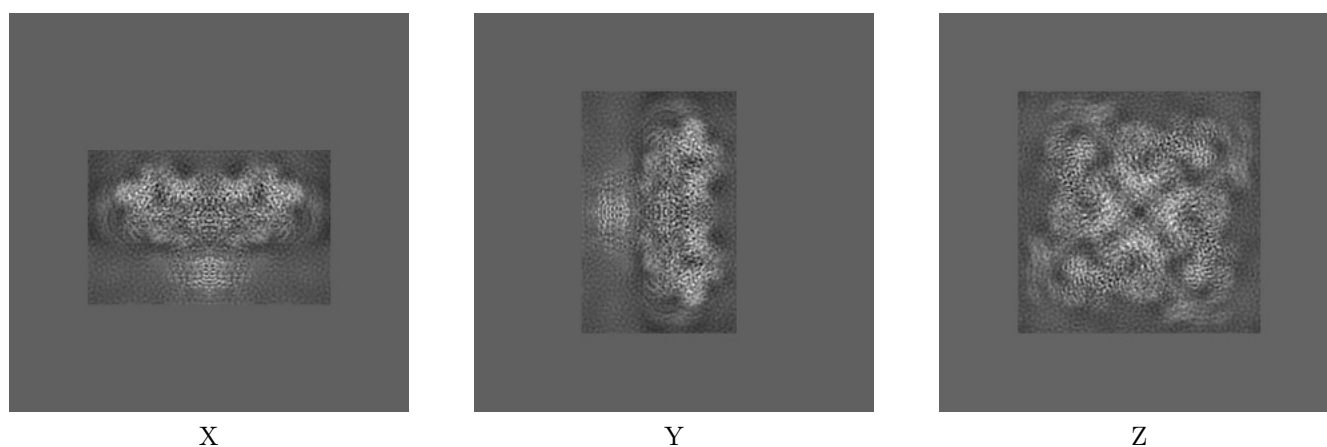

The images above show the map projected in three orthogonal directions.

6.2 Central slices [i](#)

6.2.1 Primary map

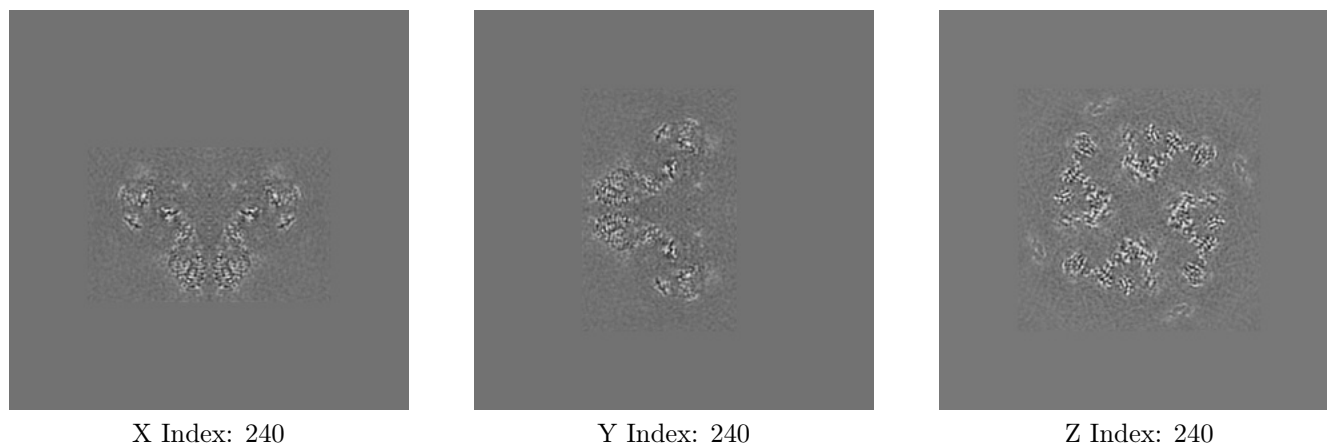

The images above show central slices of the map in three orthogonal directions.

6.3 Largest variance slices [i](#)

6.3.1 Primary map

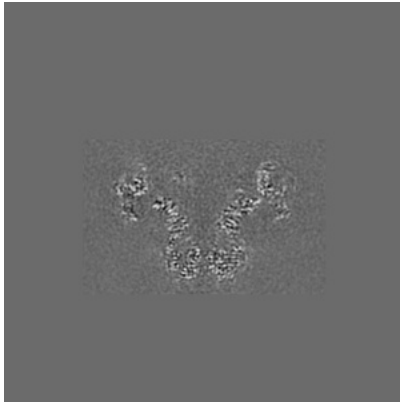

X Index: 236

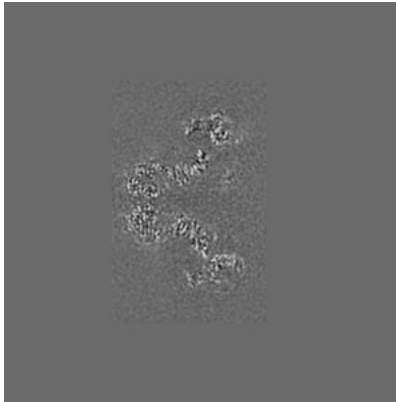

Y Index: 236

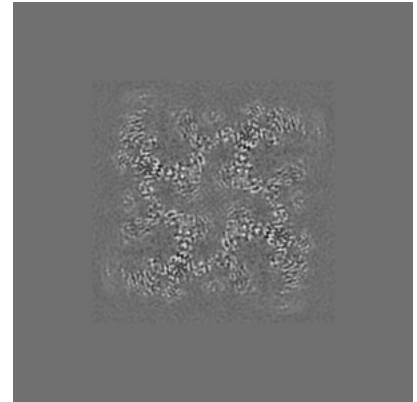

Z Index: 265

The images above show the largest variance slices of the map in three orthogonal directions.

6.4 Orthogonal standard-deviation projections (False-color) [i](#)

6.4.1 Primary map

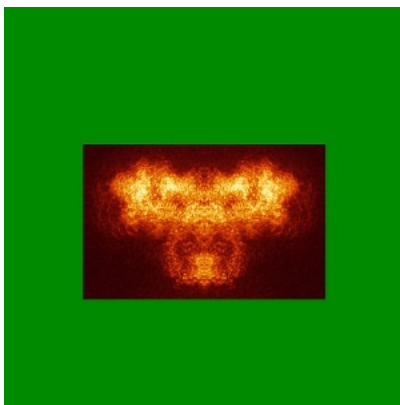

X

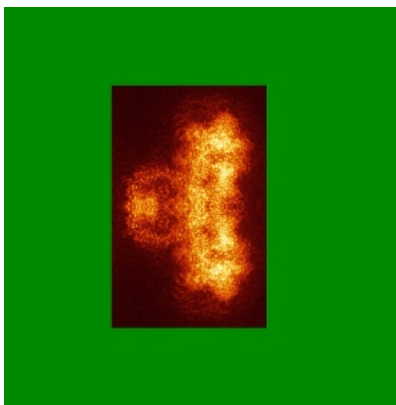

Y

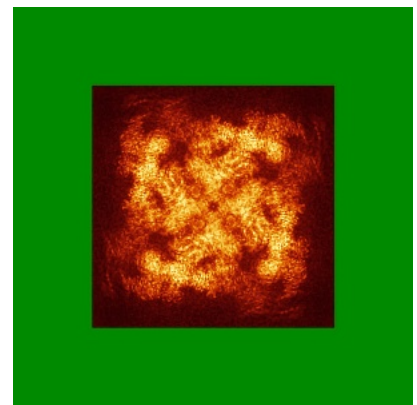

Z

The images above show the map standard deviation projections with false color in three orthogonal directions. Minimum values are shown in green, max in blue, and dark to light orange shades represent small to large values respectively.

6.5 Orthogonal surface views [i](#)

6.5.1 Primary map

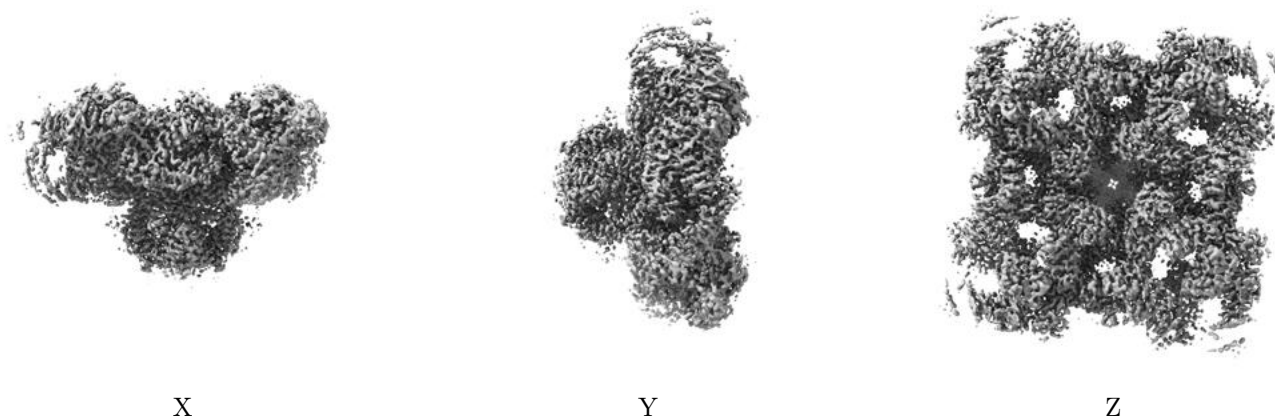

The images above show the 3D surface view of the map at the recommended contour level 0.022. These images, in conjunction with the slice images, may facilitate assessment of whether an appropriate contour level has been provided.

6.6 Mask visualisation [i](#)

This section was not generated. No masks/segmentation were deposited.

7 Map analysis [i](#)

This section contains the results of statistical analysis of the map.

7.1 Map-value distribution [i](#)

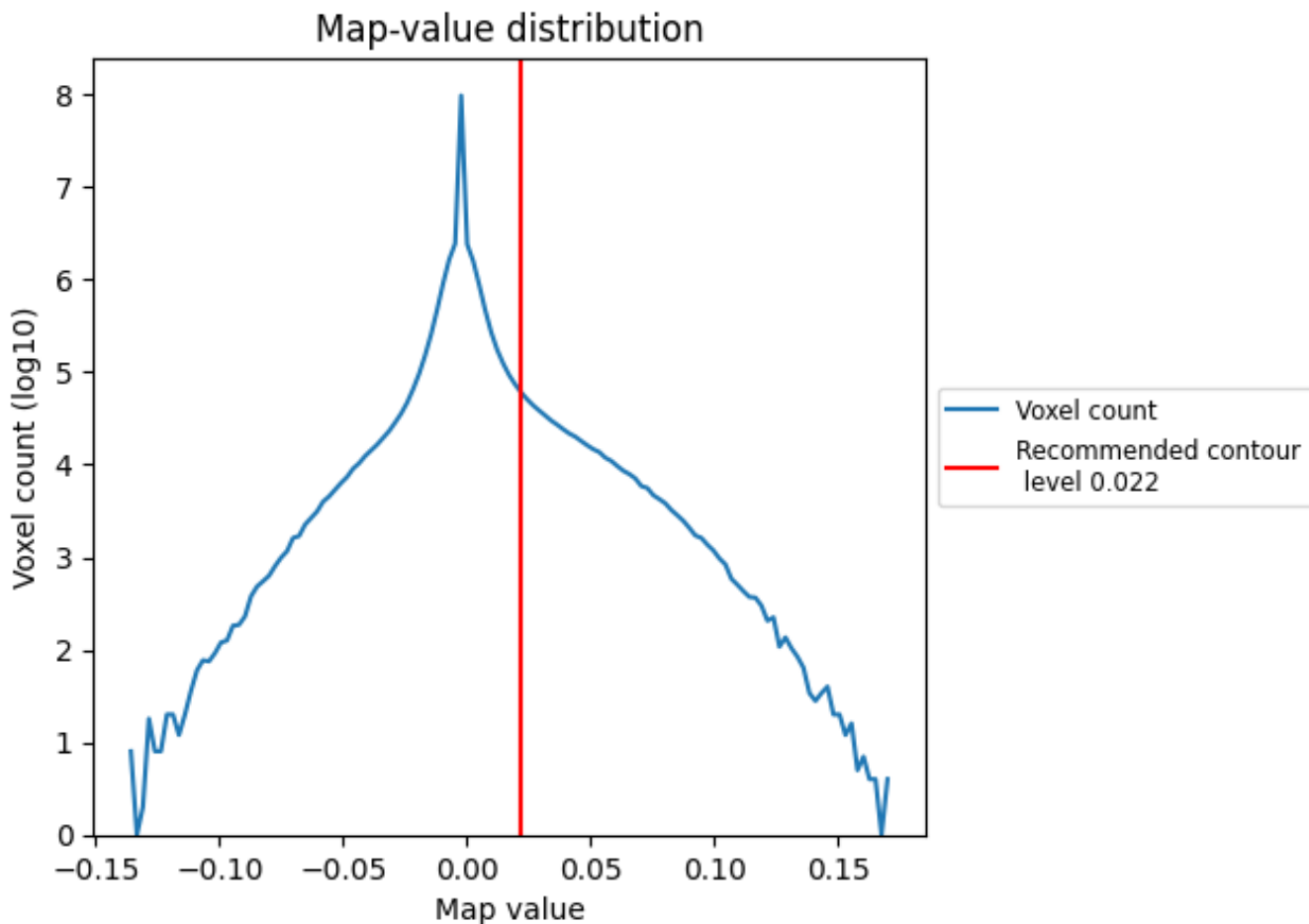

The map-value distribution is plotted in 128 intervals along the x-axis. The y-axis is logarithmic. A spike in this graph at zero usually indicates that the volume has been masked.

7.2 Volume estimate [i](#)

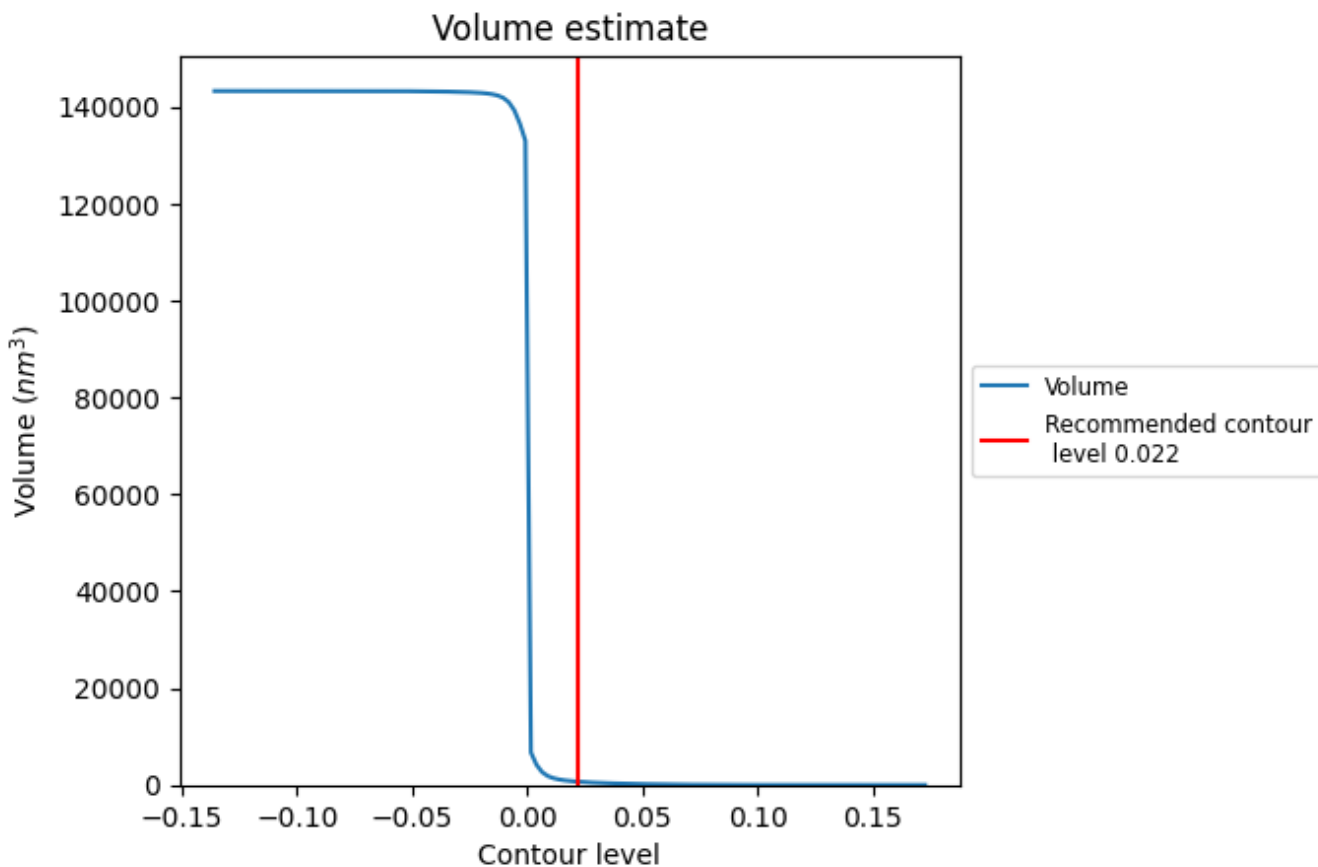

The volume at the recommended contour level is 672 nm³; this corresponds to an approximate mass of 607 kDa.

The volume estimate graph shows how the enclosed volume varies with the contour level. The recommended contour level is shown as a vertical line and the intersection between the line and the curve gives the volume of the enclosed surface at the given level.

7.3 Rotationally averaged power spectrum [\(i\)](#)

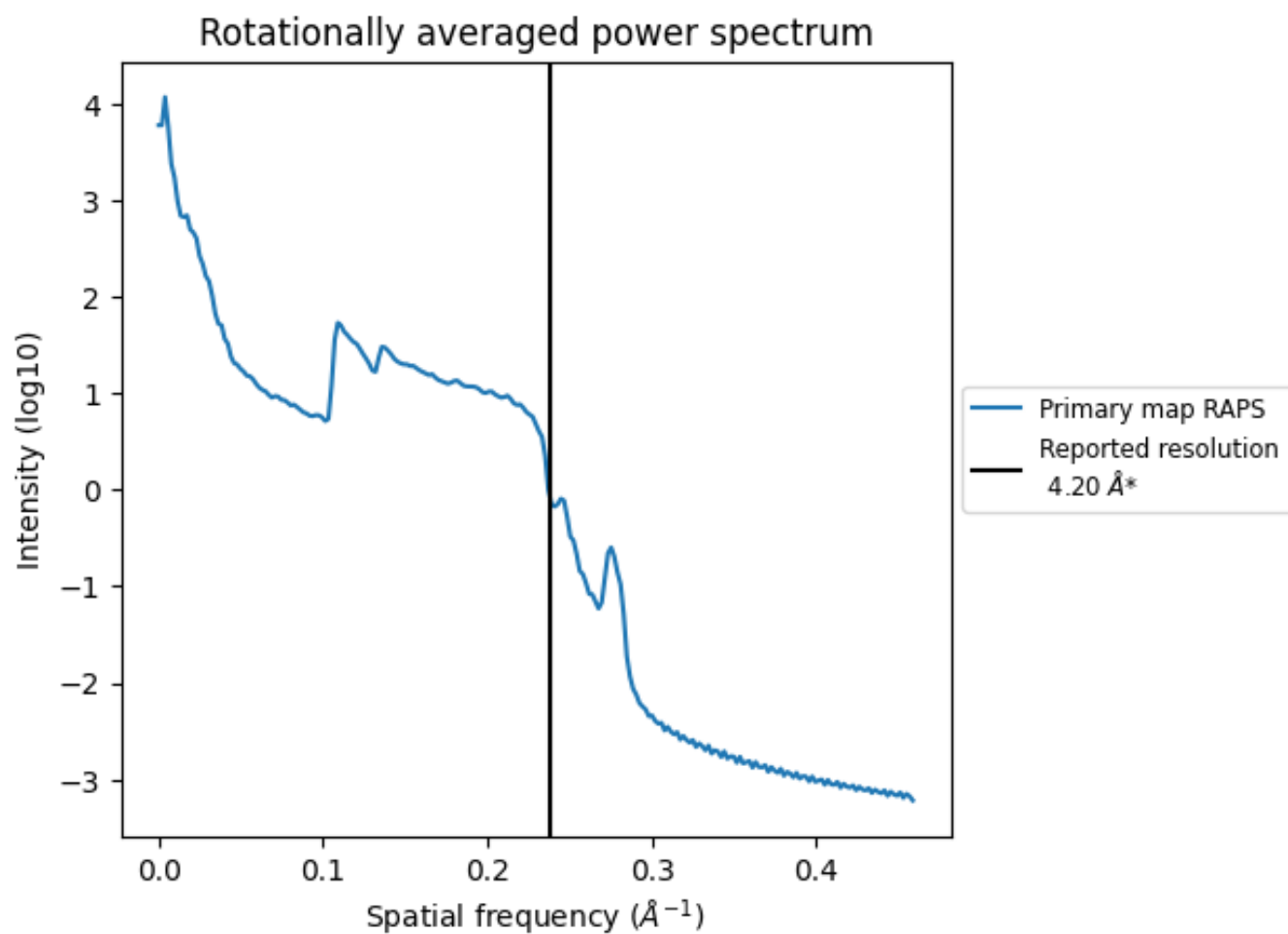

*Reported resolution corresponds to spatial frequency of 0.238\AA^{-1}

8 Fourier-Shell correlation

This section was not generated. No FSC curve or half-maps provided.

9 Map-model fit [i](#)

This section contains information regarding the fit between EMDB map EMD-22016 and PDB model 6X33. Per-residue inclusion information can be found in section 3 on page 6.

9.1 Map-model overlay [i](#)

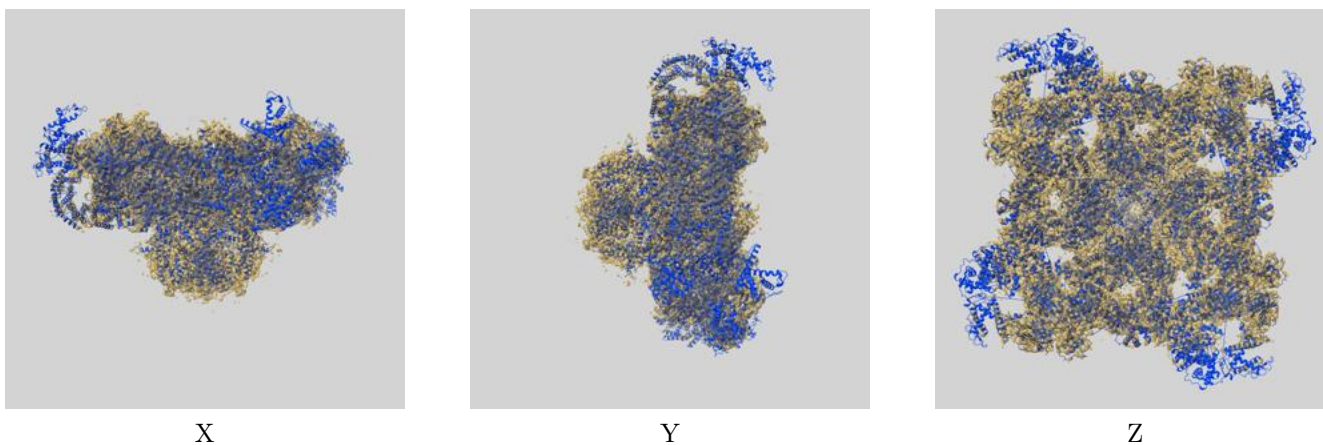

The images above show the 3D surface view of the map at the recommended contour level 0.022 at 50% transparency in yellow overlaid with a ribbon representation of the model coloured in blue. These images allow for the visual assessment of the quality of fit between the atomic model and the map.

9.2 Q-score mapped to coordinate model [i](#)

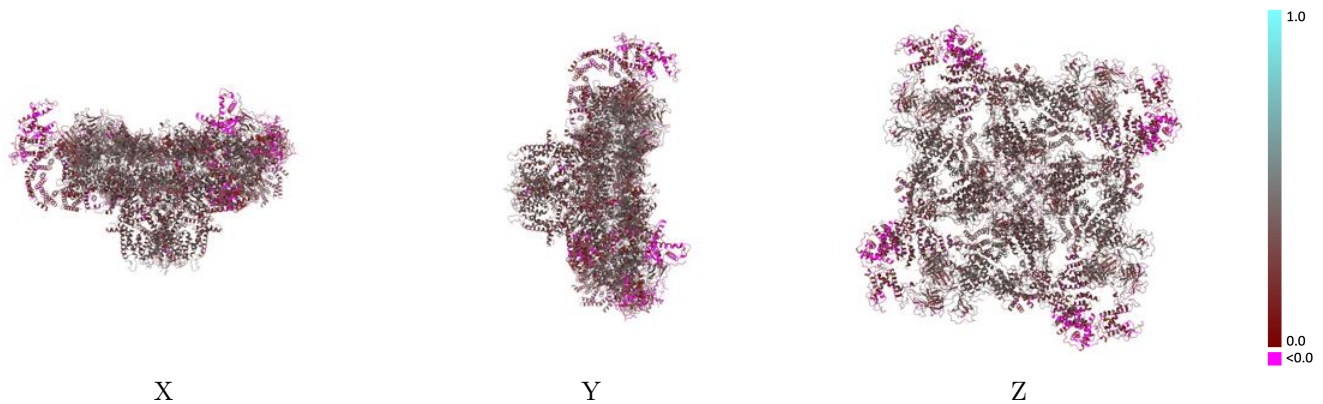

The images above show the model with each residue coloured according to its Q-score. This shows their resolvability in the map with higher Q-score values reflecting better resolvability. Please note: Q-score is calculating the resolvability of atoms, and thus high values are only expected at resolutions at which atoms can be resolved. Low Q-score values may therefore be expected for many entries.

9.3 Atom inclusion mapped to coordinate model [i](#)

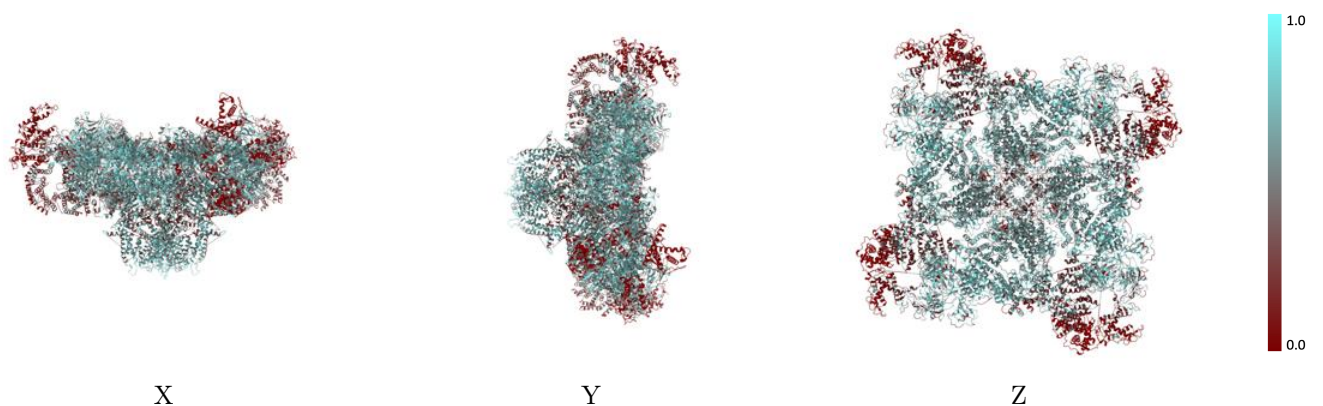

The images above show the model with each residue coloured according to its atom inclusion. This shows to what extent they are inside the map at the recommended contour level (0.022).



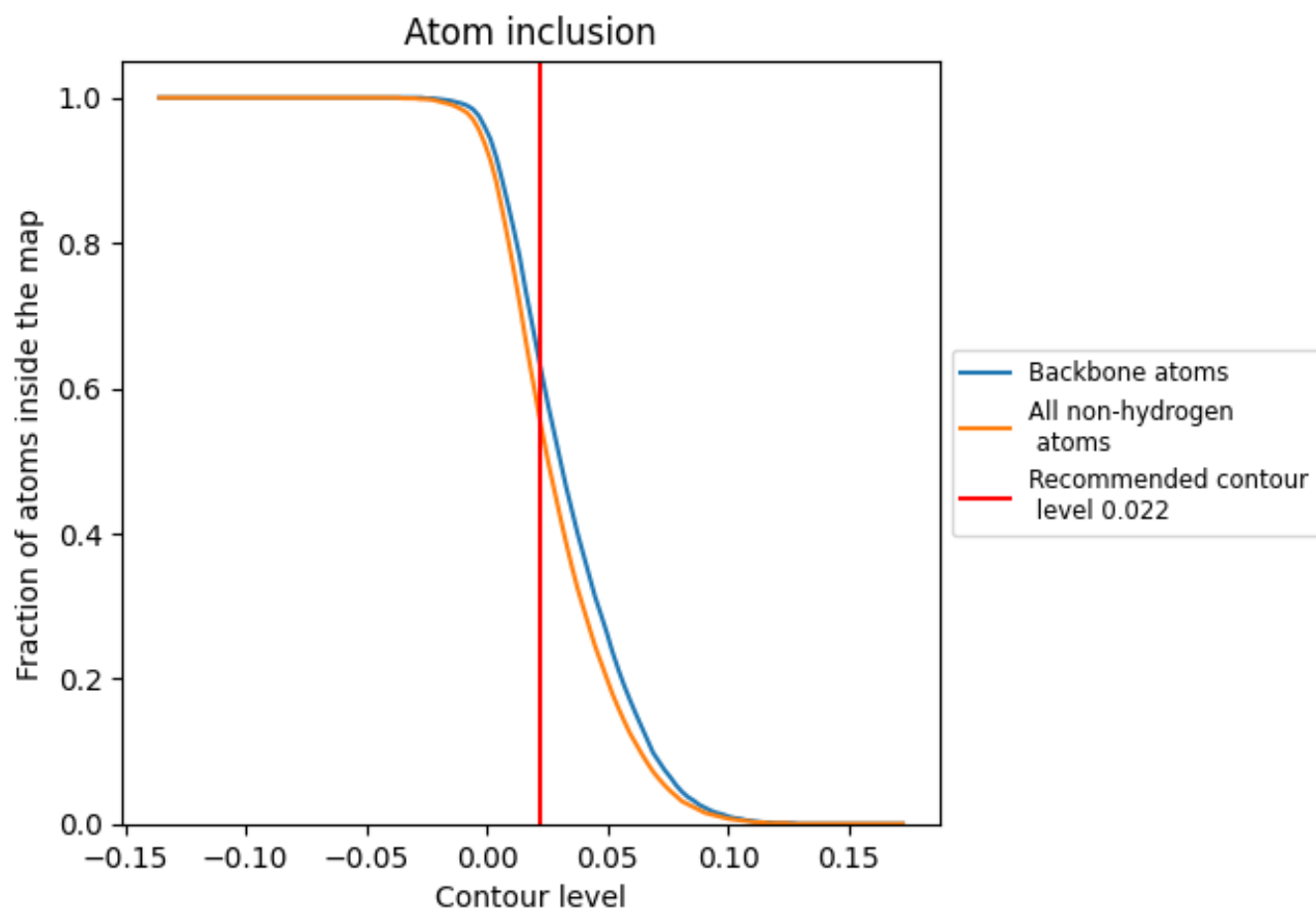























9.4 Atom inclusion [i](#)



At the recommended contour level, 63% of all backbone atoms, 56% of all non-hydrogen atoms, are inside the map.

9.5 Map-model fit summary [i](#)

The table lists the average atom inclusion at the recommended contour level (0.022) and Q-score for the entire model and for each chain.

| Chain | Atom inclusion | Q-score |
|-------|--|--|
| All |  0.5580 |  0.3230 |
| A |  0.6020 |  0.3810 |
| B |  0.5610 |  0.3230 |
| C |  0.4110 |  0.2760 |
| D |  0.6020 |  0.3780 |
| E |  0.5610 |  0.3230 |
| F |  0.4110 |  0.2740 |
| G |  0.6010 |  0.3780 |
| H |  0.5610 |  0.3230 |
| I |  0.4110 |  0.2720 |
| J |  0.6020 |  0.3790 |
| K |  0.5620 |  0.3220 |
| L |  0.4110 |  0.2750 |

