



Full wwPDB X-ray Structure Validation Report ⓘ

Sep 26, 2023 – 10:09 PM EDT

PDB ID : 6CHB
Title : Crystal structure of a natively-glycosylated BG505 SOSIP.664 HIV-1 Envelope Trimer in complex with the broadly-neutralizing antibodies BG18 and IOMA
Authors : Barnes, C.O.; Bjorkman, P.J.
Deposited on : 2018-02-22
Resolution : 6.80 Å(reported)

This is a Full wwPDB X-ray Structure Validation Report for a publicly released PDB entry.

We welcome your comments at validation@mail.wwpdb.org

A user guide is available at

<https://www.wwpdb.org/validation/2017/XrayValidationReportHelp>

with specific help available everywhere you see the ⓘ symbol.

The types of validation reports are described at

<http://www.wwpdb.org/validation/2017/FAQs#types>.

The following versions of software and data (see [references ⓘ](#)) were used in the production of this report:

MolProbity : 4.02b-467
Xtriage (Phenix) : 1.13
EDS : 2.35.1
Percentile statistics : 20191225.v01 (using entries in the PDB archive December 25th 2019)
Refmac : 5.8.0158
CCP4 : 7.0.044 (Gargrove)
Ideal geometry (proteins) : Engh & Huber (2001)
Ideal geometry (DNA, RNA) : Parkinson et al. (1996)
Validation Pipeline (wwPDB-VP) : 2.35.1

1 Overall quality at a glance

The following experimental techniques were used to determine the structure:

X-RAY DIFFRACTION

The reported resolution of this entry is 6.80 Å.

Percentile scores (ranging between 0-100) for global validation metrics of the entry are shown in the following graphic. The table shows the number of entries on which the scores are based.

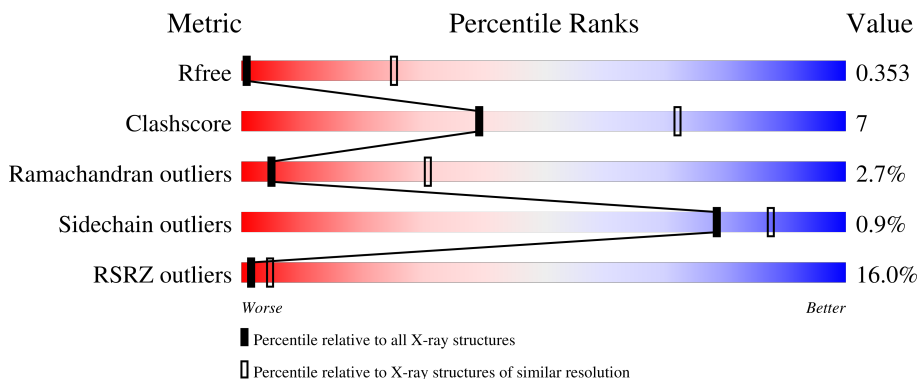

Metric	Whole archive (#Entries)	Similar resolution (#Entries, resolution range(Å))
R_{free}	130704	1003 (9.70-3.90)
Clashscore	141614	1067 (9.70-3.90)
Ramachandran outliers	138981	1001 (9.70-3.90)
Sidechain outliers	138945	1001 (9.70-3.86)
RSRZ outliers	127900	1004 (9.50-3.80)

The table below summarises the geometric issues observed across the polymeric chains and their fit to the electron density. The red, orange, yellow and green segments of the lower bar indicate the fraction of residues that contain outliers for ≥ 3 , 2, 1 and 0 types of geometric quality criteria respectively. A grey segment represents the fraction of residues that are not modelled. The numeric value for each fraction is indicated below the corresponding segment, with a dot representing fractions $\leq 5\%$. The upper red bar (where present) indicates the fraction of residues that have poor fit to the electron density. The numeric value is given above the bar.

Mol	Chain	Length	Quality of chain
1	A	153	
1	B	153	
1	C	153	
2	F	479	
2	G	479	

Continued on next page...

Continued from previous page...

Mol	Chain	Length	Quality of chain
2	H	479	
3	I	241	
3	J	241	
3	Q	241	
4	K	215	
4	L	215	
4	R	215	
5	D	232	
5	M	232	
5	O	232	
6	E	214	
6	N	214	
6	P	214	

2 Entry composition

There are 6 unique types of molecules in this entry. The entry contains 28753 atoms, of which 0 are hydrogens and 0 are deuteriums.

In the tables below, the ZeroOcc column contains the number of atoms modelled with zero occupancy, the AltConf column contains the number of residues with at least one atom in alternate conformation and the Trace column contains the number of residues modelled with at most 2 atoms.

- Molecule 1 is a protein called Envelope glycoprotein gp41.

Mol	Chain	Residues	Atoms					ZeroOcc	AltConf	Trace
			Total	C	N	O	S			
1	B	126	1001	633	172	190	6	0	0	0
1	A	126	1001	633	172	190	6	0	0	0
1	C	126	1001	633	172	190	6	0	0	0

There are 3 discrepancies between the modelled and reference sequences:

Chain	Residue	Modelled	Actual	Comment	Reference
B	605	CYS	THR	engineered mutation	UNP Q2N0S7
A	605	CYS	THR	engineered mutation	UNP Q2N0S7
C	605	CYS	THR	engineered mutation	UNP Q2N0S7

- Molecule 2 is a protein called Envelope glycoprotein gp120.

Mol	Chain	Residues	Atoms					ZeroOcc	AltConf	Trace
			Total	C	N	O	S			
2	G	450	3538	2221	624	666	27	0	0	0
2	F	450	3538	2221	624	666	27	0	0	0
2	H	450	3538	2221	624	666	27	0	0	0

There are 6 discrepancies between the modelled and reference sequences:

Chain	Residue	Modelled	Actual	Comment	Reference
G	332	ASN	THR	conflict	UNP Q2N0S6
G	501	CYS	ALA	engineered mutation	UNP Q2N0S6
F	332	ASN	THR	conflict	UNP Q2N0S6
F	501	CYS	ALA	engineered mutation	UNP Q2N0S6
H	332	ASN	THR	conflict	UNP Q2N0S6

Continued on next page...

Continued from previous page...

Chain	Residue	Modelled	Actual	Comment	Reference
H	501	CYS	ALA	engineered mutation	UNP Q2N0S6

- Molecule 3 is a protein called BG18 Heavy Chain.

Mol	Chain	Residues	Atoms					ZeroOcc	AltConf	Trace
3	J	227	Total	C	N	O	S	0	0	0
			1723	1086	297	332	8			
3	I	227	Total	C	N	O	S	0	0	0
			1723	1086	297	332	8			
3	Q	227	Total	C	N	O	S	0	0	0
			1723	1086	297	332	8			

- Molecule 4 is a protein called BG18 Light Chain.

Mol	Chain	Residues	Atoms					ZeroOcc	AltConf	Trace
4	K	205	Total	C	N	O	S	0	0	0
			1540	963	257	314	6			
4	L	205	Total	C	N	O	S	0	0	0
			1540	963	257	314	6			
4	R	205	Total	C	N	O	S	0	0	0
			1540	963	257	314	6			

- Molecule 5 is a protein called IOMA Heavy Chain.

Mol	Chain	Residues	Atoms					ZeroOcc	AltConf	Trace
5	D	125	Total	C	N	O	S	0	0	0
			992	629	173	181	9			
5	M	125	Total	C	N	O	S	0	0	0
			992	629	173	181	9			
5	O	125	Total	C	N	O	S	0	0	0
			992	629	173	181	9			

- Molecule 6 is a protein called IOMA Light Chain.

Mol	Chain	Residues	Atoms					ZeroOcc	AltConf	Trace
6	E	107	Total	C	N	O	S	0	0	0
			786	491	133	160	2			
6	N	109	Total	C	N	O	S	0	0	0
			799	498	136	163	2			
6	P	107	Total	C	N	O	S	0	0	0
			786	491	133	160	2			

3 Residue-property plots [i](#)

These plots are drawn for all protein, RNA, DNA and oligosaccharide chains in the entry. The first graphic for a chain summarises the proportions of the various outlier classes displayed in the second graphic. The second graphic shows the sequence view annotated by issues in geometry and electron density. Residues are color-coded according to the number of geometric quality criteria for which they contain at least one outlier: green = 0, yellow = 1, orange = 2 and red = 3 or more. A red dot above a residue indicates a poor fit to the electron density ($RSRZ > 2$). Stretches of 2 or more consecutive residues without any outlier are shown as a green connector. Residues present in the sample, but not in the model, are shown in grey.

- Molecule 1: Envelope glycoprotein gp41

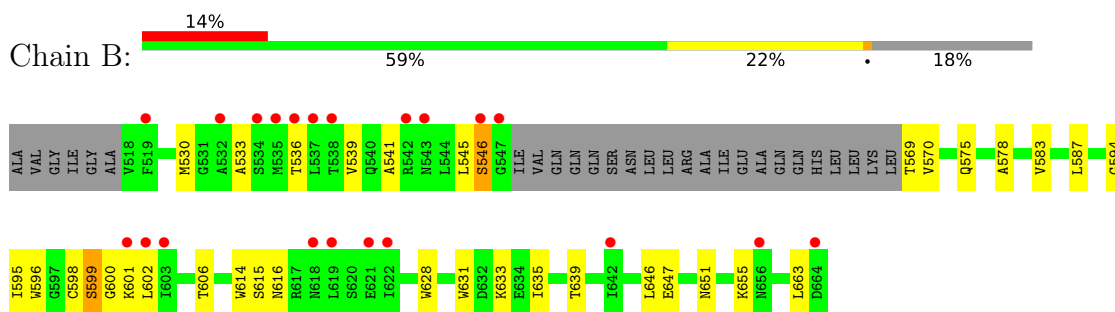

- Molecule 1: Envelope glycoprotein gp41

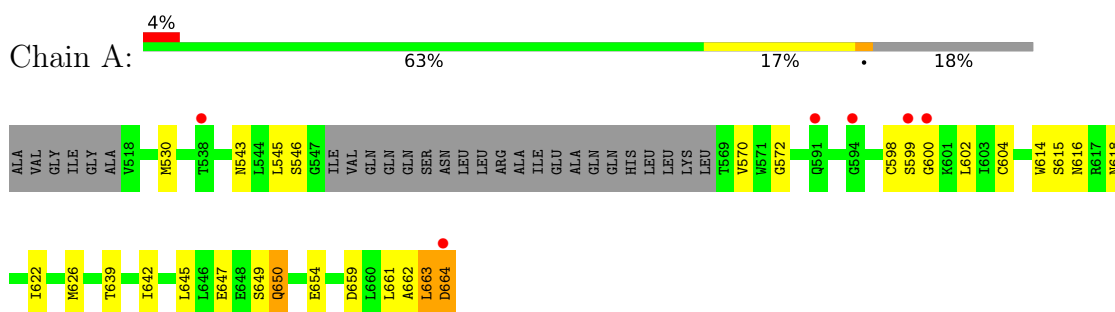

- Molecule 1: Envelope glycoprotein gp41

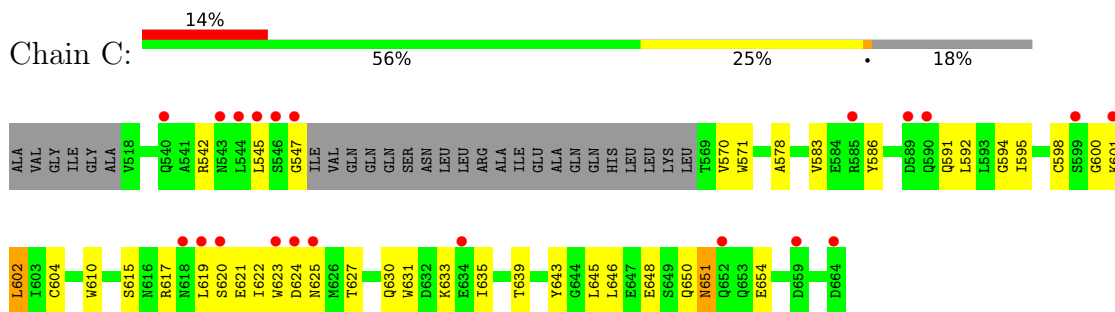

- Molecule 2: Envelope glycoprotein gp120



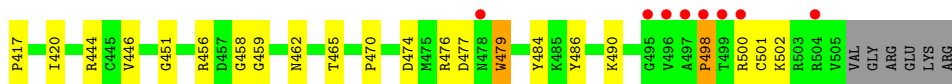

• Molecule 3: BG18 Heavy Chain

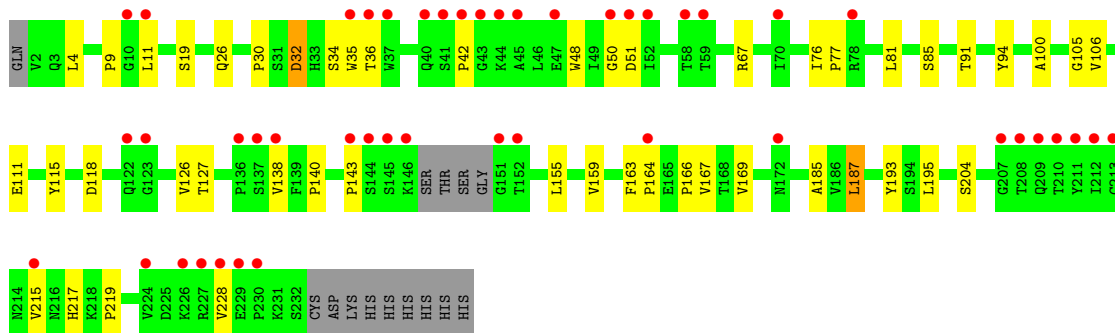
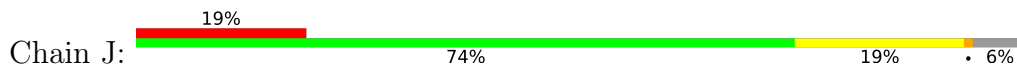

• Molecule 3: BG18 Heavy Chain

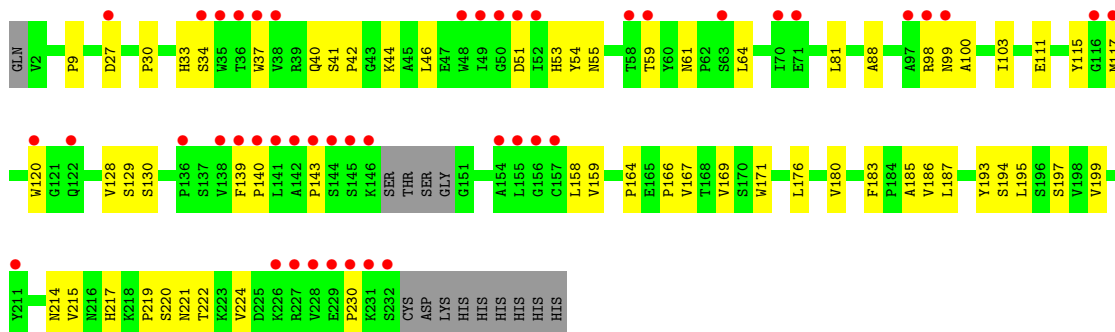

• Molecule 3: BG18 Heavy Chain

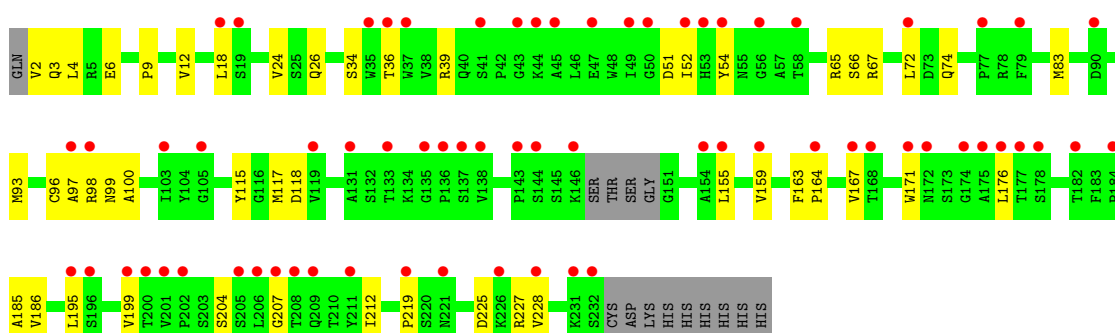
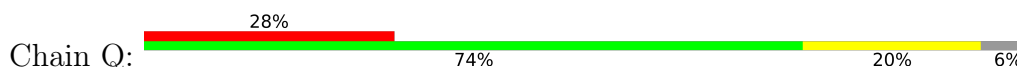

• Molecule 4: BG18 Light Chain

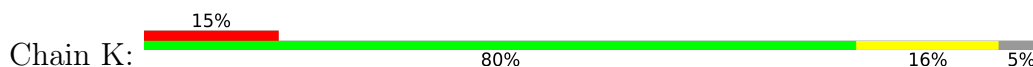

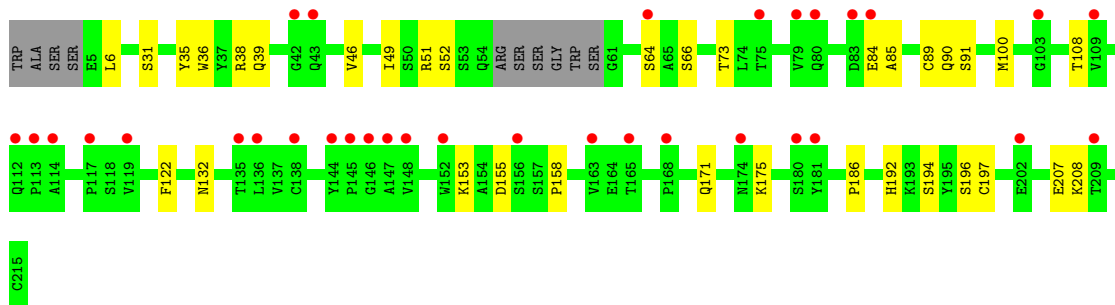

• Molecule 4: BG18 Light Chain

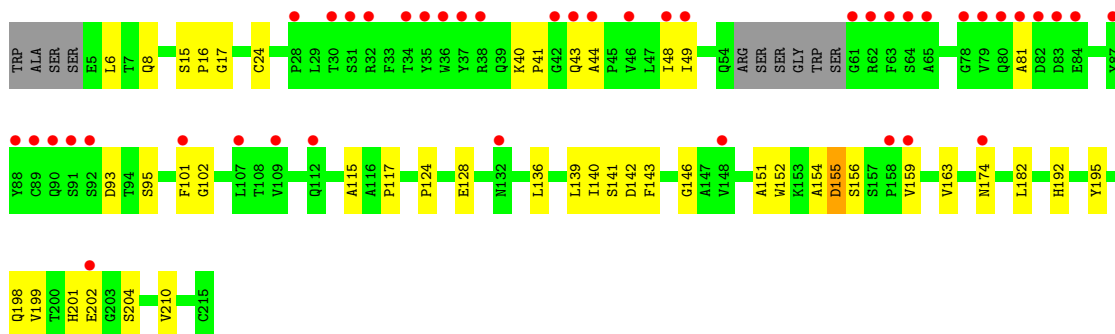
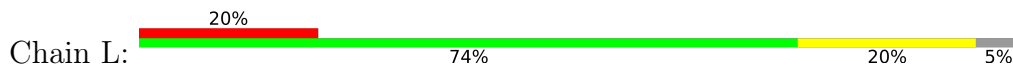

• Molecule 4: BG18 Light Chain

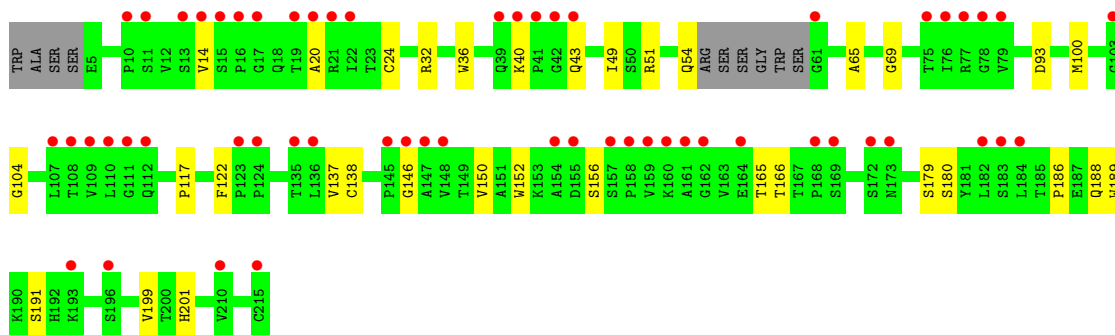
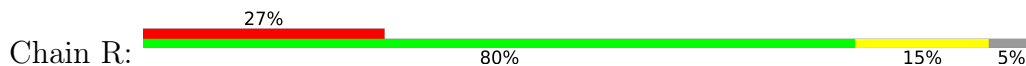

• Molecule 5: IOMA Heavy Chain

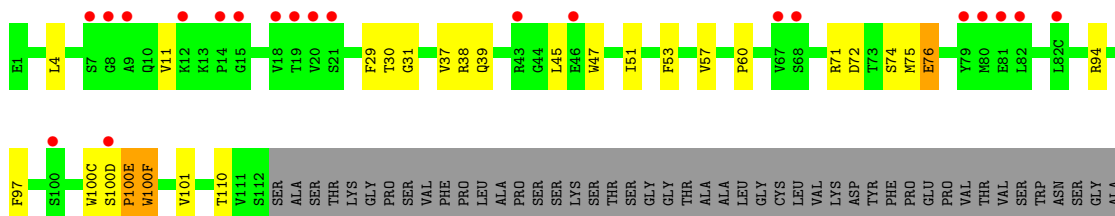

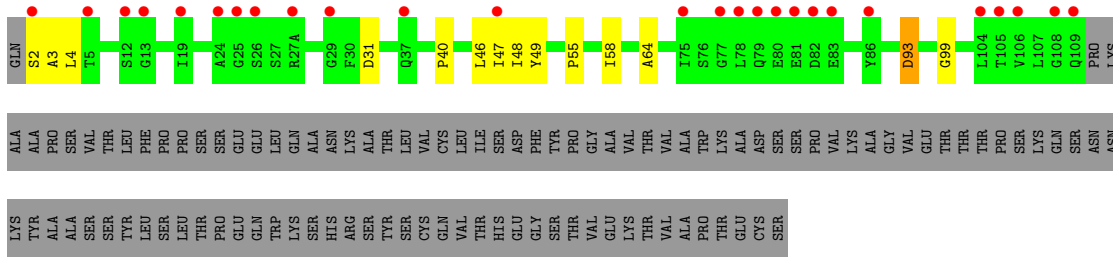

● Molecule 6: IOMA Light Chain

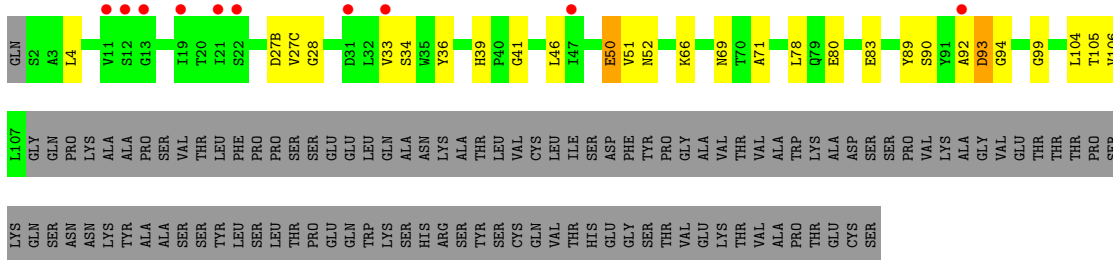
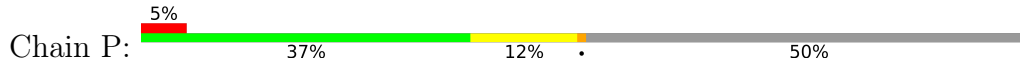

4 Data and refinement statistics

Property	Value	Source
Space group	P 43 21 2	Depositor
Cell constants a, b, c, α , β , γ	176.75Å 176.75Å 458.04Å 90.00° 90.00° 90.00°	Depositor
Resolution (Å)	39.63 – 6.80 39.63 – 6.68	Depositor EDS
% Data completeness (in resolution range)	99.7 (39.63-6.80) 99.4 (39.63-6.68)	Depositor EDS
R_{merge}	0.33	Depositor
R_{sym}	(Not available)	Depositor
$\langle I/\sigma(I) \rangle$ ¹	1.36 (at 6.65Å)	Xtrriage
Refinement program	PHENIX (1.13_2998: ???)	Depositor
R, R_{free}	0.318 , 0.417 0.328 , 0.353	Depositor DCC
R_{free} test set	670 reflections (4.88%)	wwPDB-VP
Wilson B-factor (Å ²)	369.1	Xtrriage
Anisotropy	0.560	Xtrriage
Bulk solvent k_{sol} (e/Å ³), B_{sol} (Å ²)	0.30 , 533.0	EDS
L-test for twinning ²	$\langle L \rangle = 0.41$, $\langle L^2 \rangle = 0.24$	Xtrriage
Estimated twinning fraction	No twinning to report.	Xtrriage
F_o, F_c correlation	0.80	EDS
Total number of atoms	28753	wwPDB-VP
Average B, all atoms (Å ²)	411.0	wwPDB-VP

Xtrriage's analysis on translational NCS is as follows: *The largest off-origin peak in the Patterson function is 2.64% of the height of the origin peak. No significant pseudotranslation is detected.*

¹Intensities estimated from amplitudes.

²Theoretical values of $\langle |L| \rangle$, $\langle L^2 \rangle$ for acentric reflections are 0.5, 0.333 respectively for untwinned datasets, and 0.375, 0.2 for perfectly twinned datasets.

5 Model quality [i](#)

5.1 Standard geometry [i](#)

The Z score for a bond length (or angle) is the number of standard deviations the observed value is removed from the expected value. A bond length (or angle) with $|Z| > 5$ is considered an outlier worth inspection. RMSZ is the root-mean-square of all Z scores of the bond lengths (or angles).

Mol	Chain	Bond lengths		Bond angles	
		RMSZ	# Z >5	RMSZ	# Z >5
1	A	0.25	0/1019	0.47	0/1382
1	B	0.25	0/1019	0.46	0/1382
1	C	0.25	0/1019	0.48	0/1382
2	F	0.25	0/3611	0.48	0/4903
2	G	0.26	0/3611	0.49	0/4903
2	H	0.26	0/3611	0.49	0/4903
3	I	0.25	0/1767	0.51	0/2410
3	J	0.25	0/1767	0.51	0/2410
3	Q	0.25	0/1767	0.49	0/2410
4	K	0.25	0/1577	0.48	0/2153
4	L	0.25	0/1577	0.48	0/2153
4	R	0.26	0/1577	0.46	0/2153
5	D	0.28	0/1021	0.51	0/1384
5	M	0.25	0/1021	0.51	0/1384
5	O	0.27	0/1021	0.51	0/1384
6	E	0.25	0/803	0.45	0/1088
6	N	0.26	0/816	0.47	0/1105
6	P	0.25	0/803	0.50	0/1088
All	All	0.26	0/29407	0.49	0/39977

Chiral center outliers are detected by calculating the chiral volume of a chiral center and verifying if the center is modelled as a planar moiety or with the opposite hand. A planarity outlier is detected by checking planarity of atoms in a peptide group, atoms in a mainchain group or atoms of a sidechain that are expected to be planar.

Mol	Chain	#Chirality outliers	#Planarity outliers
1	A	0	1
5	D	0	1
All	All	0	2

There are no bond length outliers.

There are no bond angle outliers.

There are no chirality outliers.

All (2) planarity outliers are listed below:

Mol	Chain	Res	Type	Group
1	A	659	ASP	Peptide
5	D	100(C)	TRP	Peptide

5.2 Too-close contacts [i](#)

In the following table, the Non-H and H(model) columns list the number of non-hydrogen atoms and hydrogen atoms in the chain respectively. The H(added) column lists the number of hydrogen atoms added and optimized by MolProbity. The Clashes column lists the number of clashes within the asymmetric unit, whereas Symm-Clashes lists symmetry-related clashes.

Mol	Chain	Non-H	H(model)	H(added)	Clashes	Symm-Clashes
1	A	1001	0	978	16	1
1	B	1001	0	979	27	0
1	C	1001	0	979	25	0
2	F	3538	0	3488	49	0
2	G	3538	0	3493	64	0
2	H	3538	0	3491	45	0
3	I	1723	0	1696	36	0
3	J	1723	0	1694	27	0
3	Q	1723	0	1694	29	0
4	K	1540	0	1492	19	0
4	L	1540	0	1492	26	0
4	R	1540	0	1492	16	0
5	D	992	0	949	16	0
5	M	992	0	947	14	0
5	O	992	0	947	16	0
6	E	786	0	758	7	0
6	N	799	0	769	7	0
6	P	786	0	758	16	0
All	All	28753	0	28096	419	1

The all-atom clashscore is defined as the number of clashes found per 1000 atoms (including hydrogen atoms). The all-atom clashscore for this structure is 7.

All (419) close contacts within the same asymmetric unit are listed below, sorted by their clash magnitude.

Atom-1	Atom-2	Interatomic distance (Å)	Clash overlap (Å)
3:Q:159:VAL:HG11	3:Q:167:VAL:HG11	1.67	0.77

Continued on next page...

Continued from previous page...

Atom-1	Atom-2	Interatomic distance (Å)	Clash overlap (Å)
6:P:83:GLU:HG3	6:P:105:THR:HA	1.66	0.77
5:M:69:MET:HE2	5:M:80:MET:HG3	1.68	0.73
3:J:140:PRO:HB3	3:J:228:VAL:HG13	1.73	0.71
2:F:295:ASN:HB2	2:F:332:ASN:HB2	1.72	0.70
2:G:212:PRO:HB2	2:G:252:LYS:HB3	1.74	0.69
6:N:46:LEU:HD21	6:N:49:TYR:HB3	1.73	0.69
2:G:301:ASN:HB3	2:G:323:ILE:HB	1.74	0.69
1:C:617:ARG:HB2	1:C:622:ILE:HG13	1.73	0.69
1:B:575:GLN:NE2	2:G:54:CYS:SG	2.66	0.69
3:I:143:PRO:HD2	3:I:230:PRO:HA	1.75	0.68
1:A:663:LEU:HA	2:H:501:CYS:HB2	1.76	0.68
5:D:39:GLN:HB2	5:D:45:LEU:HG	1.75	0.67
2:F:276:ASN:HB3	2:F:282:LYS:HG3	1.77	0.66
2:G:163:THR:O	2:G:166:ARG:NH2	2.29	0.66
2:F:170:GLN:NE2	2:F:171:LYS:O	2.29	0.66
2:F:285:LEU:HD21	2:F:481:SER:HB3	1.76	0.65
4:R:188:GLN:HA	4:R:191:SER:HB3	1.77	0.65
3:Q:2:VAL:HG11	3:Q:98:ARG:HD3	1.79	0.65
2:F:456:ARG:NH2	6:N:93:ASP:OD1	2.30	0.64
6:N:4:LEU:HB3	6:N:99:GLY:HA2	1.78	0.63
1:C:592:LEU:HD23	1:C:595:ILE:HD11	1.79	0.63
4:K:38:ARG:O	4:K:46:VAL:N	2.30	0.63
1:C:617:ARG:H	1:C:622:ILE:HD11	1.64	0.63
5:O:51:ILE:HD11	5:O:71:ARG:HD2	1.79	0.63
3:Q:2:VAL:N	3:Q:26:GLN:O	2.32	0.63
3:J:169:VAL:HG12	3:J:215:VAL:HA	1.82	0.62
3:I:40:GLN:HB2	3:I:46:LEU:HD23	1.81	0.62
2:H:270:VAL:HG21	2:H:344:LYS:HB3	1.80	0.62
2:F:131:CYS:HB3	2:F:155:LYS:HB3	1.80	0.62
1:A:650:GLN:O	1:A:654:GLU:N	2.29	0.62
3:J:185:ALA:HB2	3:J:195:LEU:HD23	1.81	0.61
5:O:41:PRO:HD3	5:O:88:ALA:HA	1.82	0.61
3:Q:164:PRO:HD2	3:Q:219:PRO:HG2	1.83	0.61
3:J:67:ARG:NH2	3:J:85:SER:O	2.33	0.61
5:D:4:LEU:HD11	5:D:94:ARG:HB3	1.83	0.61
2:G:292:VAL:HB	2:G:449:ILE:HB	1.82	0.60
3:I:34:SER:HB3	3:I:99:ASN:HB3	1.81	0.60
2:G:290:THR:OG1	2:G:344:LYS:NZ	2.34	0.60
1:B:635:ILE:O	1:B:639:THR:N	2.34	0.60
1:C:651:ASN:HA	1:C:654:GLU:HB3	1.83	0.60
3:I:33:HIS:HB3	3:I:100:ALA:HA	1.83	0.59

Continued on next page...

Continued from previous page...

Atom-1	Atom-2	Interatomic distance (Å)	Clash overlap (Å)
2:H:274:SER:HB2	2:H:284:ILE:HG23	1.85	0.59
3:J:217:HIS:CD2	3:J:219:PRO:HD2	2.38	0.59
2:H:98:ASN:ND2	2:H:486:TYR:O	2.36	0.59
1:B:606:THR:HB	1:B:646:LEU:HD21	1.83	0.58
1:B:598:CYS:O	1:B:600:GLY:N	2.36	0.58
2:G:91:GLU:HG2	2:G:487:LYS:HD3	1.85	0.58
3:Q:176:LEU:HD13	3:Q:199:VAL:HG21	1.83	0.58
5:M:97:PHE:HB3	5:M:100(E):PRO:HD3	1.84	0.58
3:I:51:ASP:OD1	3:I:59:THR:OG1	2.22	0.58
2:G:299:PRO:HG2	2:G:327:ARG:HB2	1.86	0.57
2:G:456:ARG:NH2	2:G:457:ASP:OD1	2.37	0.57
6:E:47:ILE:HG22	6:E:48:ILE:HG13	1.85	0.57
2:H:108:ILE:HD12	2:H:111:LEU:HD21	1.87	0.57
6:N:47:ILE:HG22	6:N:48:ILE:HG12	1.87	0.57
1:B:631:TRP:HE1	2:G:498:PRO:HD3	1.69	0.57
1:A:639:THR:HA	1:A:642:ILE:HB	1.86	0.57
2:F:292:VAL:HB	2:F:449:ILE:HB	1.87	0.57
3:I:41:SER:HB2	3:I:44:LYS:HB2	1.87	0.56
2:F:161:MET:O	2:F:169:LYS:HB3	2.05	0.56
2:H:294:ILE:HD11	2:H:331:CYS:SG	2.46	0.56
3:Q:186:VAL:HG13	4:R:166:THR:HB	1.88	0.56
2:G:139:THR:OG1	4:K:51:ARG:NH2	2.39	0.55
2:F:455:THR:OG1	2:F:456:ARG:N	2.39	0.55
3:J:100:ALA:HB3	3:J:115:TYR:HB3	1.87	0.55
2:F:175:LEU:H	2:F:320:THR:HB	1.71	0.55
2:H:48:ALA:HB3	2:H:490:LYS:HB2	1.88	0.55
2:G:70:ALA:HB2	2:G:111:LEU:HD21	1.89	0.55
1:A:598:CYS:O	1:A:600:GLY:N	2.40	0.55
3:I:220:SER:O	3:I:222:THR:N	2.40	0.55
3:Q:99:ASN:HA	3:Q:117:MET:HA	1.88	0.55
2:G:63:THR:HG21	2:G:213:ILE:HD12	1.88	0.54
5:M:12:LYS:HG3	5:M:18:VAL:HG22	1.90	0.54
6:P:27(C):VAL:HG13	6:P:66:LYS:HG2	1.88	0.54
2:H:108:ILE:HG21	2:H:479:TRP:HE1	1.72	0.54
1:B:606:THR:OG1	2:G:36:VAL:O	2.18	0.54
4:L:115:ALA:O	4:L:201:HIS:NE2	2.41	0.54
2:H:386:ASN:HB3	2:H:417:PRO:HD2	1.88	0.54
2:G:215:ILE:O	2:G:250:GLY:HA2	2.07	0.54
2:F:252:LYS:HD2	2:F:262:ASN:HB3	1.90	0.54
4:R:40:LYS:HB2	4:R:43:GLN:HG3	1.90	0.54
3:J:118:ASP:OD1	3:J:118:ASP:N	2.41	0.53

Continued on next page...

Continued from previous page...

Atom-1	Atom-2	Interatomic distance (Å)	Clash overlap (Å)
1:C:627:THR:O	1:C:631:TRP:N	2.37	0.53
1:B:578:ALA:HB1	2:G:220:PRO:HG3	1.89	0.53
2:F:280:ASN:ND2	2:F:457:ASP:O	2.41	0.53
6:N:55:PRO:HD2	6:N:58:ILE:HG13	1.91	0.53
2:G:286:VAL:HB	2:G:452:LEU:HB3	1.91	0.53
6:N:2:SER:OG	6:N:3:ALA:N	2.42	0.53
2:G:170:GLN:NE2	2:G:171:LYS:O	2.42	0.53
1:B:594:GLY:HA2	1:B:599:SER:HA	1.90	0.53
3:Q:98:ARG:NH2	3:Q:118:ASP:OD2	2.42	0.53
2:F:268:GLU:O	2:F:289:ASN:ND2	2.42	0.53
1:B:541:ALA:O	1:C:591:GLN:NE2	2.41	0.53
2:G:305:LYS:HB2	2:G:319:ALA:HB3	1.91	0.53
3:I:100:ALA:HB3	3:I:115:TYR:HB3	1.90	0.53
3:Q:212:ILE:HA	3:Q:227:ARG:HA	1.90	0.53
6:P:50:GLU:O	6:P:52:ASN:N	2.42	0.52
3:J:138:VAL:HG12	3:J:159:VAL:HG22	1.91	0.52
3:I:159:VAL:HG11	3:I:167:VAL:HG21	1.92	0.52
5:O:50:TRP:NE1	5:O:58:LYS:HB2	2.24	0.52
5:D:29:PHE:O	5:D:31:GLY:N	2.43	0.52
2:F:121:LYS:HA	2:F:202:THR:HA	1.90	0.52
2:F:454:LEU:HA	2:F:470:PRO:HA	1.91	0.52
2:G:130:GLN:O	2:G:157:CYS:HA	2.10	0.52
3:J:11:LEU:HD13	3:J:164:PRO:HG3	1.92	0.52
5:O:50:TRP:HE1	5:O:58:LYS:HB2	1.75	0.52
3:Q:4:LEU:HB3	3:Q:96:CYS:SG	2.50	0.52
2:F:297:THR:HA	2:F:443:ILE:O	2.10	0.52
2:G:163:THR:OG1	2:G:164:GLU:N	2.41	0.52
6:E:33:VAL:HB	6:E:51:VAL:HA	1.90	0.52
3:J:36:THR:HG22	3:J:51:ASP:HB3	1.91	0.51
5:M:39:GLN:HB2	5:M:45:LEU:HG	1.91	0.51
3:I:169:VAL:HG21	3:I:197:SER:CB	2.40	0.51
2:H:239:CYS:HB2	2:H:242:VAL:HG22	1.92	0.51
5:M:40:ALA:HB3	5:M:43:ARG:HB2	1.91	0.51
6:P:92:ALA:O	6:P:94:GLY:N	2.44	0.51
2:H:283:ASN:ND2	2:H:477:ASP:OD2	2.30	0.51
2:H:476:ARG:HD2	5:O:100(A):ALA:HA	1.91	0.51
2:G:65:LYS:HB2	2:G:68:VAL:HG23	1.93	0.51
4:L:163:VAL:HG22	4:L:182:LEU:HB2	1.91	0.51
1:C:650:GLN:O	1:C:654:GLU:N	2.40	0.51
2:G:110:SER:HA	2:G:113:ASP:HB2	1.92	0.51
2:G:252:LYS:HD2	2:G:262:ASN:HB3	1.91	0.51

Continued on next page...

Continued from previous page...

Atom-1	Atom-2	Interatomic distance (Å)	Clash overlap (Å)
2:G:261:LEU:HB3	2:G:447:SER:OG	2.11	0.51
2:F:161:MET:N	2:F:170:GLN:O	2.38	0.51
1:C:578:ALA:HB1	2:H:220:PRO:HG3	1.93	0.51
4:K:196:SER:HA	4:K:208:LYS:O	2.10	0.51
5:O:52:ASN:HB3	5:O:56:ALA:HB3	1.93	0.51
5:D:75:MET:C	5:D:76:GLU:HG3	2.32	0.50
2:H:96:TRP:HE1	5:O:100(B):ASP:HB3	1.76	0.50
3:I:169:VAL:HA	3:I:214:ASN:O	2.12	0.50
1:B:614:TRP:O	1:B:616:ASN:N	2.43	0.50
3:I:139:PHE:HB2	3:I:158:LEU:HB3	1.94	0.50
3:I:164:PRO:HD2	3:I:219:PRO:HB3	1.94	0.50
2:G:426:MET:HG3	2:G:427:TRP:H	1.77	0.50
2:F:385:CYS:HA	2:F:418:CYS:HA	1.92	0.50
1:C:601:LYS:O	1:C:602:LEU:HB2	2.10	0.50
4:L:154:ALA:O	4:L:156:SER:N	2.44	0.50
5:D:97:PHE:HB2	5:D:100(E):PRO:HG3	1.93	0.50
6:P:4:LEU:HB2	6:P:99:GLY:HA2	1.93	0.50
2:G:122:LEU:HD11	2:G:203:GLN:HB2	1.94	0.50
3:J:143:PRO:HB3	3:J:155:LEU:HB3	1.94	0.50
2:G:254:VAL:HG21	2:G:262:ASN:HB2	1.93	0.49
2:H:297:THR:OG1	2:H:330:HIS:NE2	2.44	0.49
2:G:312:GLY:HA2	2:G:315:GLN:HB2	1.94	0.49
2:H:61:TYR:CD1	2:H:71:THR:HB	2.48	0.49
2:F:462:ASN:O	2:F:464:THR:N	2.39	0.49
3:Q:52:ILE:HD11	3:Q:72:LEU:HB2	1.94	0.49
2:G:327:ARG:HG2	3:J:111:GLU:HG2	1.95	0.49
2:F:120:VAL:O	2:F:203:GLN:N	2.45	0.49
5:M:100(E):PRO:HG2	5:M:100(G):ARG:HG2	1.95	0.49
2:H:372:THR:O	2:H:387:THR:OG1	2.21	0.49
1:B:601:LYS:HG2	1:C:594:GLY:HA3	1.94	0.49
5:D:100(F):TRP:CD1	5:D:100(F):TRP:N	2.77	0.49
1:B:596:TRP:HA	1:B:651:ASN:ND2	2.28	0.48
1:B:546:SER:HB2	2:G:221:ALA:HB2	1.95	0.48
3:J:91:THR:HG23	3:J:127:THR:HA	1.94	0.48
1:A:645:LEU:O	1:A:649:SER:N	2.41	0.48
3:Q:36:THR:HB	3:Q:51:ASP:HB3	1.94	0.48
3:I:120:TRP:HB2	4:L:44:ALA:HB1	1.96	0.48
4:R:117:PRO:HD3	4:R:201:HIS:HB3	1.95	0.48
2:G:214:PRO:HA	2:G:251:ILE:O	2.12	0.48
3:J:167:VAL:HG22	3:J:217:HIS:HA	1.94	0.48
4:L:201:HIS:N	4:L:204:SER:O	2.45	0.48

Continued on next page...

Continued from previous page...

Atom-1	Atom-2	Interatomic distance (Å)	Clash overlap (Å)
2:H:129:LEU:HB3	2:H:157:CYS:HB3	1.95	0.48
4:L:6:LEU:HB2	4:L:102:GLY:HA2	1.95	0.48
2:H:364:SER:HB2	2:H:470:PRO:HG2	1.95	0.48
4:L:140:ILE:HG12	4:L:199:VAL:HG21	1.95	0.48
3:I:186:VAL:HG12	3:I:194:SER:O	2.14	0.48
2:H:459:GLY:HA3	6:P:93:ASP:HB3	1.96	0.48
4:L:93:ASP:OD2	4:L:95:SER:OG	2.25	0.48
2:H:296:CYS:O	2:H:444:ARG:HG3	2.13	0.48
4:L:141:SER:OG	4:L:142:ASP:OD2	2.28	0.48
1:B:602:LEU:HG	1:C:595:ILE:HA	1.96	0.47
3:I:176:LEU:HD13	3:I:199:VAL:HG21	1.97	0.47
5:O:23:THR:HA	5:O:77:ILE:HG13	1.96	0.47
3:Q:65:ARG:O	3:Q:67:ARG:N	2.47	0.47
2:F:64:GLU:O	2:F:68:VAL:HG23	2.14	0.47
1:C:617:ARG:HB3	1:C:621:GLU:HB2	1.96	0.47
2:H:370:GLU:OE1	2:H:370:GLU:N	2.46	0.47
2:G:412:ASP:OD1	2:G:412:ASP:N	2.48	0.47
3:Q:155:LEU:HD13	3:Q:228:VAL:HG11	1.96	0.47
2:G:218:CYS:HA	2:G:246:GLN:O	2.14	0.47
2:G:138:ILE:HG21	4:K:31:SER:HA	1.97	0.47
2:H:254:VAL:HG21	2:H:262:ASN:HB2	1.96	0.47
6:P:27(C):VAL:HG11	6:P:71:ALA:H	1.80	0.47
4:R:51:ARG:NH2	4:R:54:GLN:OE1	2.48	0.47
1:B:536:THR:HB	1:B:539:VAL:HG22	1.97	0.47
2:G:193:LEU:HB2	2:G:196:CYS:SG	2.55	0.47
2:H:378:CYS:HB3	2:H:383:PHE:CD1	2.50	0.47
4:R:24:CYS:HB2	4:R:36:TRP:CH2	2.50	0.47
1:A:614:TRP:O	1:A:616:ASN:N	2.48	0.47
4:L:195:TYR:N	4:L:210:VAL:O	2.48	0.47
3:I:180:VAL:HG12	3:I:199:VAL:HG23	1.97	0.47
1:C:592:LEU:HA	1:C:595:ILE:HG12	1.97	0.47
2:H:360:ARG:HG2	2:H:361:PHE:N	2.30	0.47
5:D:38:ARG:O	5:D:45:LEU:HA	2.14	0.46
2:F:161:MET:O	2:F:170:GLN:N	2.43	0.46
4:L:117:PRO:HD3	4:L:201:HIS:HB3	1.97	0.46
1:C:598:CYS:O	1:C:600:GLY:N	2.42	0.46
3:Q:36:THR:HA	3:Q:51:ASP:HA	1.96	0.46
2:G:428:GLN:HG3	5:D:53:PHE:CZ	2.51	0.46
1:C:620:SER:HA	1:C:624:ASP:HB2	1.97	0.46
1:B:596:TRP:HE1	1:B:647:GLU:HB2	1.80	0.46
6:E:65:SER:OG	6:E:72:SER:OG	2.33	0.46

Continued on next page...

Continued from previous page...

Atom-1	Atom-2	Interatomic distance (Å)	Clash overlap (Å)
1:B:646:LEU:HD23	1:B:646:LEU:HA	1.68	0.46
2:F:65:LYS:HB2	2:F:68:VAL:HG22	1.97	0.46
4:L:201:HIS:CD2	4:L:202:GLU:HG3	2.51	0.46
6:P:33:VAL:HG12	6:P:90:SER:HB2	1.97	0.46
2:G:307:ILE:HB	2:G:317:PHE:HB3	1.97	0.46
2:F:130:GLN:O	2:F:157:CYS:HA	2.16	0.46
2:H:296:CYS:HA	2:H:331:CYS:HA	1.98	0.46
3:Q:171:TRP:HB2	3:Q:176:LEU:HB2	1.97	0.46
2:G:260:LEU:HB3	2:G:451:GLY:HA3	1.98	0.46
5:D:37:VAL:CG1	5:D:45:LEU:HB3	2.45	0.46
3:I:183:PHE:CD1	4:L:139:LEU:HD13	2.51	0.46
1:B:663:LEU:HD21	2:F:499:THR:HB	1.97	0.46
2:H:35:TRP:O	2:H:498:PRO:HA	2.15	0.46
6:E:92:ALA:O	6:E:94:GLY:N	2.49	0.46
2:F:457:ASP:HA	5:M:58:LYS:HD2	1.98	0.46
3:Q:100:ALA:HB3	3:Q:115:TYR:HB3	1.98	0.46
2:F:296:CYS:HA	2:F:331:CYS:HA	1.98	0.45
3:Q:185:ALA:HA	3:Q:195:LEU:HB3	1.97	0.45
3:J:34:SER:HB3	3:J:51:ASP:HB2	1.97	0.45
4:K:132:ASN:HA	4:K:186:PRO:HG3	1.97	0.45
2:F:57:ASP:HA	2:F:77:THR:H	1.82	0.45
2:F:218:CYS:HA	2:F:246:GLN:O	2.17	0.45
2:F:312:GLY:HA3	2:F:313:PRO:C	2.36	0.45
5:M:96:MET:HB2	5:M:100(H):GLY:HA3	1.99	0.45
3:I:98:ARG:O	3:I:117:MET:HA	2.17	0.45
2:H:95:MET:HB3	2:H:484:TYR:HA	1.98	0.45
3:J:4:LEU:HD21	3:J:35:TRP:HZ3	1.80	0.45
3:J:106:VAL:HB	3:J:111:GLU:OE1	2.17	0.45
3:J:155:LEU:HA	4:K:122:PHE:CZ	2.52	0.45
2:F:460:SER:OG	2:F:461:THR:N	2.46	0.45
3:Q:12:VAL:HG21	3:Q:18:LEU:HB2	1.98	0.45
3:J:94:TYR:CE1	3:J:126:VAL:HB	2.52	0.45
2:G:391:PHE:CZ	2:G:470:PRO:HB3	2.52	0.45
3:I:171:TRP:HB2	3:I:176:LEU:HB2	1.98	0.45
3:I:176:LEU:HB3	3:I:199:VAL:HG21	1.97	0.45
3:Q:54:TYR:OH	3:Q:74:GLN:O	2.31	0.45
2:G:161:MET:O	2:G:170:GLN:N	2.50	0.45
2:G:227:LYS:O	2:G:242:VAL:HA	2.17	0.45
3:J:155:LEU:HA	4:K:122:PHE:HZ	1.81	0.45
1:A:543:ASN:HA	1:A:546:SER:HB2	1.99	0.45
1:A:663:LEU:HD23	1:A:664:ASP:HB2	1.97	0.45

Continued on next page...

Continued from previous page...

Atom-1	Atom-2	Interatomic distance (Å)	Clash overlap (Å)
2:F:131:CYS:HB3	2:F:155:LYS:CB	2.45	0.45
1:B:595:ILE:HG21	1:B:647:GLU:HG3	1.98	0.45
2:G:78:ASP:O	2:G:80:ASN:N	2.50	0.45
2:G:425:ASN:HB2	2:G:433:ALA:HB2	1.98	0.45
3:I:129:SER:OG	3:I:130:SER:N	2.49	0.45
3:Q:36:THR:HG23	3:Q:97:ALA:HB3	1.98	0.45
2:F:227:LYS:HA	2:F:485:LYS:O	2.17	0.45
5:M:6:GLU:HG2	5:M:22:CYS:HB2	1.98	0.45
3:I:139:PHE:CZ	4:L:128:GLU:HG3	2.52	0.45
4:L:48:ILE:HG13	4:L:49:ILE:HG12	1.98	0.45
1:B:530:MET:HA	1:B:533:ALA:HB3	1.99	0.44
4:L:40:LYS:HB2	4:L:43:GLN:HG3	1.98	0.44
4:L:124:PRO:HD3	4:L:136:LEU:HD23	1.99	0.44
5:O:51:ILE:CD1	5:O:71:ARG:HD2	2.47	0.44
1:C:630:GLN:O	1:C:633:LYS:HG2	2.17	0.44
2:H:386:ASN:N	2:H:417:PRO:O	2.40	0.44
3:I:37:TRP:CG	3:I:81:LEU:HD22	2.52	0.44
3:I:217:HIS:CE1	3:I:219:PRO:HB2	2.52	0.44
6:P:36:TYR:CZ	6:P:46:LEU:HD13	2.53	0.44
4:R:138:CYS:HB2	4:R:152:TRP:CH2	2.52	0.44
6:P:34:SER:O	6:P:89:TYR:N	2.43	0.44
4:R:122:PHE:HB2	4:R:137:VAL:HB	2.00	0.44
3:I:53:HIS:O	3:I:55:ASN:N	2.51	0.44
3:I:169:VAL:HG21	3:I:197:SER:HB3	1.99	0.44
6:P:78:LEU:HD21	6:P:104:LEU:HD11	1.98	0.44
2:F:131:CYS:HB2	2:F:191:TYR:CD1	2.53	0.44
4:L:152:TRP:HB2	4:L:159:VAL:HB	1.98	0.44
2:G:300:ASN:HB3	2:G:322:ILE:HG23	1.99	0.44
2:F:416:LEU:HA	2:F:417:PRO:HD3	1.88	0.44
3:I:46:LEU:O	4:L:101:PHE:HB2	2.17	0.44
2:F:286:VAL:HB	2:F:452:LEU:HB3	1.99	0.44
1:C:545:LEU:O	1:C:547:GLY:N	2.50	0.44
2:G:276:ASN:O	2:G:278:THR:N	2.49	0.44
5:D:100(E):PRO:HB2	5:D:100(F):TRP:H	1.50	0.44
2:F:327:ARG:HD2	3:I:111:GLU:HG2	1.99	0.44
3:I:185:ALA:HA	3:I:195:LEU:HB3	2.00	0.44
5:O:47:TRP:CZ3	5:O:60:PRO:HD3	2.53	0.44
4:K:171:GLN:N	4:K:175:LYS:O	2.37	0.43
1:C:635:ILE:O	1:C:639:THR:HG23	2.18	0.43
2:G:64:GLU:O	2:G:68:VAL:HG23	2.18	0.43
3:J:187:LEU:HD13	3:J:193:TYR:CE1	2.53	0.43

Continued on next page...

Continued from previous page...

Atom-1	Atom-2	Interatomic distance (Å)	Clash overlap (Å)
1:A:570:VAL:HG21	2:F:114:GLN:HG3	1.99	0.43
2:F:303:THR:HB	2:F:321:GLY:HA3	1.99	0.43
1:B:587:LEU:HB3	1:A:545:LEU:HD21	2.01	0.43
2:G:105:HIS:CG	2:G:476:ARG:HG2	2.54	0.43
2:F:294:ILE:HG13	2:F:333:VAL:HG22	2.01	0.43
2:G:61:TYR:OH	2:G:74:CYS:O	2.35	0.43
4:K:35:TYR:O	4:K:90:GLN:N	2.52	0.43
5:D:37:VAL:HG12	5:D:45:LEU:HB3	1.99	0.43
1:A:662:ALA:HB1	2:H:501:CYS:SG	2.58	0.43
4:K:36:TRP:HB2	4:K:49:ILE:HB	2.00	0.43
5:D:97:PHE:O	5:D:100(E):PRO:HD3	2.18	0.43
3:I:103:ILE:HG13	3:I:111:GLU:O	2.18	0.43
2:H:35:TRP:CZ2	2:H:502:LYS:HD3	2.53	0.43
4:R:150:VAL:HG22	4:R:199:VAL:HG13	2.00	0.43
4:R:165:THR:HA	4:R:180:SER:HA	2.01	0.43
3:J:48:TRP:CZ2	3:J:50:GLY:HA2	2.53	0.43
5:D:47:TRP:CZ3	5:D:60:PRO:HG3	2.54	0.43
6:E:37:GLN:HG3	6:E:86:TYR:CE2	2.54	0.43
3:Q:2:VAL:HG21	3:Q:98:ARG:HH11	1.83	0.43
3:Q:67:ARG:O	3:Q:83:MET:HA	2.19	0.43
2:G:38:VAL:HG13	2:G:494:LEU:HD11	1.99	0.43
2:G:268:GLU:O	2:G:289:ASN:ND2	2.52	0.43
3:J:11:LEU:HD12	3:J:127:THR:O	2.18	0.43
1:A:647:GLU:OE2	1:C:542:ARG:HB3	2.18	0.43
2:H:294:ILE:O	2:H:446:VAL:HA	2.18	0.43
2:F:109:ILE:O	2:F:112:TRP:HB3	2.19	0.43
1:C:619:LEU:O	1:C:623:TRP:HB3	2.19	0.43
5:O:11:VAL:HG13	5:O:110:THR:HB	2.01	0.43
2:G:307:ILE:HG22	2:G:309:ILE:HG23	2.01	0.43
3:Q:39:ARG:HA	3:Q:93:MET:O	2.19	0.43
6:P:27(C):VAL:HG11	6:P:71:ALA:N	2.34	0.43
2:G:300:ASN:HB3	2:G:322:ILE:HD12	2.01	0.42
5:M:18:VAL:HG23	5:M:82(C):LEU:HD11	2.00	0.42
3:I:61:ASN:HB3	3:I:64:LEU:HD12	2.01	0.42
4:L:151:ALA:HB3	4:L:198:GLN:HB3	2.01	0.42
6:N:48:ILE:HG21	6:N:64:ALA:HB3	2.00	0.42
2:H:65:LYS:HD2	2:H:207:LYS:O	2.19	0.42
1:B:569:THR:OG1	1:B:570:VAL:N	2.49	0.42
2:G:152:GLY:C	2:G:154:LEU:H	2.22	0.42
2:G:359:ILE:HG23	2:G:468:PHE:CE1	2.54	0.42
3:J:163:PHE:HA	3:J:164:PRO:HA	1.90	0.42

Continued on next page...

Continued from previous page...

Atom-1	Atom-2	Interatomic distance (Å)	Clash overlap (Å)
6:E:35:TRP:CE3	6:E:88:CYS:HB2	2.54	0.42
4:L:143:PHE:HB2	4:L:201:HIS:CE1	2.55	0.42
4:K:153:LYS:HA	4:K:158:PRO:HA	2.00	0.42
1:A:530:MET:N	1:A:626:MET:O	2.49	0.42
1:A:618:ASN:O	1:A:622:ILE:HG13	2.20	0.42
2:G:385:CYS:HA	2:G:417:PRO:O	2.19	0.42
4:K:6:LEU:HD11	4:K:91:SER:HB3	2.01	0.42
4:L:81:ALA:O	4:L:174:ASN:ND2	2.42	0.42
3:Q:163:PHE:HA	3:Q:164:PRO:HA	1.87	0.42
2:G:270:VAL:HG11	2:G:345:VAL:HG22	2.02	0.42
2:G:296:CYS:HA	2:G:331:CYS:HA	2.01	0.42
2:F:65:LYS:HB2	2:F:68:VAL:CG2	2.50	0.42
2:F:255:VAL:O	2:F:376:PHE:HA	2.19	0.42
1:C:583:VAL:HA	1:C:586:TYR:HB3	2.00	0.42
6:P:78:LEU:HD13	6:P:104:LEU:HD21	2.01	0.42
6:P:80:GLU:HG2	6:P:106:VAL:HG21	2.02	0.42
3:Q:98:ARG:O	3:Q:118:ASP:N	2.53	0.42
4:R:14:VAL:HG21	4:R:20:ALA:HB2	2.02	0.42
5:O:4:LEU:HD13	5:O:92:CYS:HB2	2.01	0.42
5:O:70:THR:OG1	5:O:71:ARG:N	2.49	0.42
4:R:186:PRO:O	4:R:189:TRP:HB3	2.20	0.42
1:B:533:ALA:HB1	1:B:628:TRP:CD1	2.55	0.42
1:B:655:LYS:HG3	1:A:602:LEU:HD12	2.01	0.42
2:G:214:PRO:HG3	2:G:252:LYS:HE2	2.02	0.42
3:I:27:ASP:OD1	3:I:27:ASP:N	2.51	0.42
2:H:259:LEU:HB2	2:H:374:HIS:CE1	2.55	0.42
4:R:166:THR:HG22	4:R:179:SER:H	1.84	0.42
1:B:545:LEU:HD21	1:B:583:VAL:HA	2.01	0.42
5:M:51:ILE:HD11	5:M:71:ARG:HD2	2.01	0.42
3:Q:3:GLN:O	3:Q:24:VAL:HA	2.20	0.42
4:R:150:VAL:HG22	4:R:199:VAL:HG22	2.00	0.42
4:L:143:PHE:CE1	4:L:146:GLY:HA2	2.55	0.41
2:H:181:VAL:HG12	2:H:193:LEU:HD23	2.02	0.41
3:J:32:ASP:N	3:J:32:ASP:OD1	2.53	0.41
5:D:11:VAL:HG13	5:D:110:THR:O	2.20	0.41
3:I:187:LEU:HB2	3:I:193:TYR:CE2	2.56	0.41
2:H:260:LEU:HB3	2:H:451:GLY:N	2.36	0.41
2:H:397:SER:OG	2:H:398:ASN:N	2.52	0.41
1:B:546:SER:CB	2:G:221:ALA:HB2	2.49	0.41
6:P:28:GLY:CA	6:P:69:ASN:HA	2.50	0.41
4:K:36:TRP:CH2	4:K:89:CYS:HB3	2.55	0.41

Continued on next page...

Continued from previous page...

Atom-1	Atom-2	Interatomic distance (Å)	Clash overlap (Å)
4:K:90:GLN:HG2	4:K:100:MET:O	2.20	0.41
2:H:256:SER:HA	2:H:375:SER:O	2.19	0.41
2:G:328:GLN:HE22	2:G:420:ILE:HG13	1.85	0.41
2:G:477:ASP:HA	2:G:480:ARG:HD2	2.02	0.41
2:F:163:THR:OG1	2:F:164:GLU:N	2.52	0.41
1:C:646:LEU:HD23	1:C:646:LEU:HA	1.94	0.41
3:Q:34:SER:O	3:Q:99:ASN:N	2.53	0.41
4:K:155:ASP:HA	4:K:194:SER:OG	2.20	0.41
3:I:88:ALA:HA	3:I:128:VAL:HB	2.03	0.41
4:K:197:CYS:O	4:K:207:GLU:HA	2.20	0.41
2:F:122:LEU:HD11	2:F:203:GLN:HB2	2.03	0.41
2:F:369:LEU:HB3	2:F:384:TYR:CD2	2.56	0.41
1:C:570:VAL:O	1:C:571:TRP:HB2	2.21	0.41
2:H:122:LEU:HB3	2:H:125:LEU:HD23	2.02	0.41
2:H:456:ARG:NH2	2:H:458:GLY:O	2.54	0.41
2:G:364:SER:HB2	2:G:470:PRO:HG2	2.03	0.41
3:J:19:SER:HA	3:J:81:LEU:O	2.20	0.41
3:J:76:ILE:H	3:J:77:PRO:HA	1.86	0.41
4:K:39:GLN:O	4:K:85:ALA:HB1	2.20	0.41
4:K:66:SER:N	4:K:73:THR:O	2.46	0.41
2:F:192:ARG:HD2	2:F:193:LEU:O	2.21	0.41
3:I:215:VAL:O	3:I:224:VAL:N	2.52	0.41
4:L:8:GLN:HG2	4:L:24:CYS:HB2	2.02	0.41
4:L:155:ASP:HB2	4:L:192:HIS:HB3	2.01	0.41
1:C:619:LEU:HD22	2:H:500:ARG:HD2	2.02	0.41
5:O:5:VAL:HB	5:O:23:THR:HB	2.02	0.41
3:Q:6:GLU:HG3	3:Q:96:CYS:SG	2.61	0.41
4:R:32:ARG:HG3	4:R:93:ASP:O	2.21	0.41
2:H:345:VAL:O	2:H:349:LEU:HG	2.21	0.41
2:H:382:PHE:O	2:H:420:ILE:HA	2.21	0.41
4:K:84:GLU:HG3	4:K:108:THR:HA	2.03	0.40
1:A:650:GLN:HG2	1:A:654:GLU:HB2	2.03	0.40
2:F:274:SER:HB3	2:F:277:ILE:HG22	2.03	0.40
2:H:90:THR:HB	2:H:238:PRO:HB2	2.03	0.40
5:O:100(E):PRO:HB2	5:O:100(F):TRP:H	1.64	0.40
6:P:39:HIS:O	6:P:41:GLY:N	2.54	0.40
4:R:49:ILE:HD13	4:R:65:ALA:HB2	2.04	0.40
2:G:262:ASN:N	2:G:447:SER:OG	2.55	0.40
5:D:51:ILE:HA	5:D:57:VAL:HG12	2.03	0.40
4:L:15:SER:O	4:L:17:GLY:N	2.54	0.40
5:M:17:SER:HB3	5:M:82(A):SER:HA	2.03	0.40

Continued on next page...

Continued from previous page...

Atom-1	Atom-2	Interatomic distance (Å)	Clash overlap (Å)
1:B:545:LEU:HD23	1:B:545:LEU:HA	1.72	0.40
5:D:101:VAL:HG13	6:E:46:LEU:HD22	2.03	0.40
2:F:369:LEU:O	2:F:373:THR:OG1	2.26	0.40
5:M:23:THR:HA	5:M:77:ILE:HA	2.03	0.40
5:M:87:THR:HG23	5:M:109:VAL:O	2.21	0.40
1:C:620:SER:O	1:C:625:ASN:HB2	2.22	0.40
2:H:300:ASN:HB3	2:H:322:ILE:HD13	2.03	0.40
5:O:100(C):TRP:O	5:O:100(D):SER:OG	2.37	0.40

All (1) symmetry-related close contacts are listed below. The label for Atom-2 includes the symmetry operator and encoded unit-cell translations to be applied.

Atom-1	Atom-2	Interatomic distance (Å)	Clash overlap (Å)
1:A:661:LEU:O	1:A:663:LEU:N[8_554]	2.16	0.04

5.3 Torsion angles [i](#)

5.3.1 Protein backbone [i](#)

In the following table, the Percentiles column shows the percent Ramachandran outliers of the chain as a percentile score with respect to all X-ray entries followed by that with respect to entries of similar resolution.

The Analysed column shows the number of residues for which the backbone conformation was analysed, and the total number of residues.

Mol	Chain	Analysed	Favoured	Allowed	Outliers	Percentiles	
1	A	122/153 (80%)	93 (76%)	24 (20%)	5 (4%)	3	22
1	B	122/153 (80%)	104 (85%)	15 (12%)	3 (2%)	5	32
1	C	122/153 (80%)	97 (80%)	20 (16%)	5 (4%)	3	22
2	F	442/479 (92%)	363 (82%)	71 (16%)	8 (2%)	8	40
2	G	442/479 (92%)	377 (85%)	51 (12%)	14 (3%)	4	26
2	H	442/479 (92%)	370 (84%)	57 (13%)	15 (3%)	3	26
3	I	223/241 (92%)	195 (87%)	21 (9%)	7 (3%)	4	27
3	J	223/241 (92%)	188 (84%)	27 (12%)	8 (4%)	3	25
3	Q	223/241 (92%)	195 (87%)	24 (11%)	4 (2%)	8	40
4	K	201/215 (94%)	175 (87%)	24 (12%)	2 (1%)	15	54

Continued on next page...

Continued from previous page...

Mol	Chain	Analysed	Favoured	Allowed	Outliers	Percentiles	
4	L	201/215 (94%)	174 (87%)	24 (12%)	3 (2%)	10	46
4	R	201/215 (94%)	175 (87%)	22 (11%)	4 (2%)	7	38
5	D	123/232 (53%)	103 (84%)	16 (13%)	4 (3%)	4	26
5	M	123/232 (53%)	106 (86%)	12 (10%)	5 (4%)	3	22
5	O	123/232 (53%)	98 (80%)	22 (18%)	3 (2%)	6	33
6	E	105/214 (49%)	88 (84%)	16 (15%)	1 (1%)	15	54
6	N	107/214 (50%)	91 (85%)	13 (12%)	3 (3%)	5	30
6	P	105/214 (49%)	81 (77%)	20 (19%)	4 (4%)	3	24
All	All	3650/4602 (79%)	3073 (84%)	479 (13%)	98 (3%)	5	31

All (98) Ramachandran outliers are listed below:

Mol	Chain	Res	Type
5	D	74	SER
5	D	100(E)	PRO
5	M	100(E)	PRO
3	I	30	PRO
3	I	166	PRO
3	I	221	ASN
1	C	602	LEU
1	C	615	SER
2	H	331	CYS
5	O	100(E)	PRO
3	Q	204	SER
1	B	599	SER
2	G	135	THR
2	G	268	GLU
2	G	301	ASN
2	G	392	ASN
3	J	9	PRO
3	J	30	PRO
3	J	204	SER
1	A	599	SER
1	A	615	SER
5	M	100(H)	GLY
3	I	54	TYR
2	H	33	ASN
2	H	98	ASN
6	P	93	ASP

Continued on next page...

Continued from previous page...

Mol	Chain	Res	Type
4	R	69	GLY
4	R	104	GLY
4	R	146	GLY
1	B	546	SER
1	B	615	SER
2	G	69	TRP
2	G	117	LYS
2	G	258	GLN
2	G	277	ILE
2	G	391	PHE
5	D	30	THR
6	E	33	VAL
1	A	663	LEU
2	F	118	PRO
2	F	138	ILE
2	F	392	ASN
2	F	428	GLN
3	I	9	PRO
4	L	155	ASP
1	C	645	LEU
2	H	69	TRP
2	H	96	TRP
2	H	135	THR
2	H	301	ASN
2	H	474	ASP
6	P	27(B)	ASP
3	Q	66	SER
3	Q	207	GLY
2	G	354	GLY
2	G	499	THR
3	J	187	LEU
2	F	69	TRP
2	F	258	GLN
1	C	610	TRP
2	H	138	ILE
2	H	258	GLN
2	H	462	ASN
2	H	465	THR
2	H	498	PRO
6	P	51	VAL
4	R	156	SER
2	G	138	ILE

Continued on next page...

Continued from previous page...

Mol	Chain	Res	Type
3	J	105	GLY
4	K	52	SER
4	K	192	HIS
1	A	650	GLN
2	F	220	PRO
5	M	29	PHE
6	N	31	ASP
6	N	40	PRO
6	N	93	ASP
2	H	118	PRO
2	H	220	PRO
5	O	53	PHE
6	P	50	GLU
3	Q	9	PRO
3	J	26	GLN
5	M	60	PRO
4	L	16	PRO
1	C	648	GLU
2	G	118	PRO
2	G	430	ILE
3	J	42	PRO
1	A	572	GLY
2	F	498	PRO
3	I	42	PRO
3	I	140	PRO
4	L	41	PRO
5	M	100(D)	SER
5	O	26	GLY
5	D	100(D)	SER
3	J	166	PRO

5.3.2 Protein sidechains [i](#)

In the following table, the Percentiles column shows the percent sidechain outliers of the chain as a percentile score with respect to all X-ray entries followed by that with respect to entries of similar resolution.

The Analysed column shows the number of residues for which the sidechain conformation was analysed, and the total number of residues.

Mol	Chain	Analysed	Rotameric	Outliers	Percentiles
1	A	108/129 (84%)	106 (98%)	2 (2%)	57 75

Continued on next page...

Continued from previous page...

Mol	Chain	Analysed	Rotameric	Outliers	Percentiles	
1	B	108/129 (84%)	107 (99%)	1 (1%)	78	87
1	C	108/129 (84%)	105 (97%)	3 (3%)	43	65
2	F	401/426 (94%)	397 (99%)	4 (1%)	76	86
2	G	401/426 (94%)	400 (100%)	1 (0%)	93	96
2	H	401/426 (94%)	396 (99%)	5 (1%)	71	83
3	I	195/208 (94%)	195 (100%)	0	100	100
3	J	195/208 (94%)	194 (100%)	1 (0%)	88	93
3	Q	195/208 (94%)	194 (100%)	1 (0%)	88	93
4	K	174/182 (96%)	173 (99%)	1 (1%)	86	92
4	L	174/182 (96%)	174 (100%)	0	100	100
4	R	174/182 (96%)	173 (99%)	1 (1%)	86	92
5	D	104/197 (53%)	100 (96%)	4 (4%)	33	57
5	M	104/197 (53%)	102 (98%)	2 (2%)	57	75
5	O	104/197 (53%)	102 (98%)	2 (2%)	57	75
6	E	85/177 (48%)	84 (99%)	1 (1%)	71	83
6	N	86/177 (49%)	86 (100%)	0	100	100
6	P	85/177 (48%)	85 (100%)	0	100	100
All	All	3202/3957 (81%)	3173 (99%)	29 (1%)	78	87

All (29) residues with a non-rotameric sidechain are listed below:

Mol	Chain	Res	Type
1	B	633	LYS
2	G	275	GLU
3	J	32	ASP
4	K	64	SER
5	D	71	ARG
5	D	72	ASP
5	D	76	GLU
5	D	100(F)	TRP
6	E	88	CYS
1	A	604	CYS
1	A	664	ASP
2	F	49	GLU
2	F	67	ASN
2	F	466	GLU

Continued on next page...

Continued from previous page...

Mol	Chain	Res	Type
2	F	469	ARG
5	M	59	TYR
5	M	71	ARG
1	C	604	CYS
1	C	643	TYR
1	C	651	ASN
2	H	52	LEU
2	H	228	CYS
2	H	296	CYS
2	H	331	CYS
2	H	479	TRP
5	O	71	ARG
5	O	100(F)	TRP
3	Q	225	ASP
4	R	100	MET

Sometimes sidechains can be flipped to improve hydrogen bonding and reduce clashes. All (1) such sidechains are listed below:

Mol	Chain	Res	Type
2	F	170	GLN

5.3.3 RNA [i](#)

There are no RNA molecules in this entry.

5.4 Non-standard residues in protein, DNA, RNA chains [i](#)

There are no non-standard protein/DNA/RNA residues in this entry.

5.5 Carbohydrates [i](#)

There are no monosaccharides in this entry.

5.6 Ligand geometry [i](#)

There are no ligands in this entry.

5.7 Other polymers [i](#)

There are no such residues in this entry.

5.8 Polymer linkage issues [i](#)

There are no chain breaks in this entry.

6 Fit of model and data

6.1 Protein, DNA and RNA chains

In the following table, the column labelled ‘#RSRZ > 2’ contains the number (and percentage) of RSRZ outliers, followed by percent RSRZ outliers for the chain as percentile scores relative to all X-ray entries and entries of similar resolution. The OWAB column contains the minimum, median, 95th percentile and maximum values of the occupancy-weighted average B-factor per residue. The column labelled ‘Q < 0.9’ lists the number of (and percentage) of residues with an average occupancy less than 0.9.

Mol	Chain	Analysed	<RSRZ>	#RSRZ>2	OWAB(Å ²)	Q<0.9
1	A	126/153 (82%)	0.37	6 (4%) 30 29	365, 471, 570, 691	0
1	B	126/153 (82%)	0.94	21 (16%) 1 4	309, 438, 494, 548	0
1	C	126/153 (82%)	0.83	21 (16%) 1 4	329, 445, 536, 592	0
2	F	450/479 (93%)	0.51	35 (7%) 13 15	209, 400, 510, 597	0
2	G	450/479 (93%)	0.76	53 (11%) 4 8	212, 372, 474, 595	0
2	H	450/479 (93%)	0.68	49 (10%) 5 9	241, 392, 532, 589	0
3	I	227/241 (94%)	1.11	45 (19%) 1 3	277, 411, 505, 576	0
3	J	227/241 (94%)	0.94	46 (20%) 1 3	270, 380, 474, 594	0
3	Q	227/241 (94%)	1.48	68 (29%) 0 2	341, 442, 578, 700	0
4	K	205/215 (95%)	0.95	33 (16%) 1 4	297, 386, 473, 543	0
4	L	205/215 (95%)	1.16	43 (20%) 1 3	324, 407, 503, 613	0
4	R	205/215 (95%)	1.39	57 (27%) 0 2	354, 521, 620, 698	0
5	D	125/232 (53%)	1.04	21 (16%) 1 4	237, 362, 466, 541	0
5	M	125/232 (53%)	1.20	33 (26%) 0 2	303, 386, 510, 581	0
5	O	125/232 (53%)	0.60	14 (11%) 5 9	223, 325, 420, 472	0
6	E	107/214 (50%)	0.80	14 (13%) 3 7	319, 436, 537, 605	0
6	N	109/214 (50%)	1.24	26 (23%) 0 2	351, 457, 555, 582	0
6	P	107/214 (50%)	0.56	10 (9%) 8 11	290, 406, 493, 559	0
All	All	3722/4602 (80%)	0.89	595 (15%) 1 5	209, 409, 546, 700	0

All (595) RSRZ outliers are listed below:

Mol	Chain	Res	Type	RSRZ
2	G	187	SER	12.6
3	Q	232	SER	9.6
2	G	188	ASN	8.5

Continued on next page...

Continued from previous page...

Mol	Chain	Res	Type	RSRZ
2	G	31	ALA	7.7
2	G	32	GLU	7.5
5	M	109	VAL	7.1
4	L	90	GLN	6.7
3	I	70	ILE	6.7
6	E	107	LEU	6.7
2	H	211	GLU	6.4
3	I	228	VAL	6.4
4	R	123	PRO	6.3
2	H	394	THR	6.2
2	G	496	VAL	6.2
5	D	8	GLY	6.2
3	I	140	PRO	6.1
2	H	500	ARG	6.0
4	L	36	TRP	6.0
3	Q	143	PRO	5.9
2	G	498	PRO	5.9
4	R	161	ALA	5.9
3	J	45	ALA	5.8
3	Q	136	PRO	5.8
3	J	43	GLY	5.7
6	N	80	GLU	5.6
1	B	534	SER	5.6
3	I	58	THR	5.5
2	G	214	PRO	5.5
3	Q	175	ALA	5.5
5	D	43	ARG	5.4
2	G	33	ASN	5.4
4	L	34	THR	5.4
2	G	497	ALA	5.4
4	K	42	GLY	5.4
1	B	535	MET	5.4
3	I	227	ARG	5.3
6	N	2	SER	5.3
4	L	37	TYR	5.2
6	N	79	GLN	5.2
5	M	86	ASP	5.2
6	E	13	GLY	5.2
4	R	160	LYS	5.2
3	I	51	ASP	5.2
3	I	156	GLY	5.0
6	E	14	SER	5.0

Continued on next page...

Continued from previous page...

Mol	Chain	Res	Type	RSRZ
3	I	52	ILE	5.0
3	Q	135	GLY	5.0
1	B	546	SER	5.0
2	H	498	PRO	5.0
2	F	32	GLU	5.0
4	R	135	THR	5.0
2	H	213	ILE	4.9
1	B	536	THR	4.9
4	R	147	ALA	4.9
4	L	31	SER	4.8
1	C	620	SER	4.8
3	I	122	GLN	4.7
1	C	619	LEU	4.7
3	J	47	GLU	4.7
4	L	79	VAL	4.7
2	H	499	THR	4.7
3	J	144	SER	4.7
4	L	83	ASP	4.6
2	H	220	PRO	4.6
6	E	15	PRO	4.6
6	E	78	LEU	4.6
5	D	80	MET	4.6
2	H	219	ALA	4.6
3	I	155	LEU	4.6
3	I	144	SER	4.6
2	G	51	THR	4.5
3	Q	176	LEU	4.5
3	J	211	TYR	4.5
4	R	159	VAL	4.5
4	R	172	SER	4.5
6	E	106	VAL	4.5
6	N	83	GLU	4.5
3	I	35	TRP	4.5
6	N	82	ASP	4.5
3	I	117	MET	4.5
5	D	20	VAL	4.5
3	Q	167	VAL	4.4
3	I	143	PRO	4.4
3	J	41	SER	4.3
1	B	537	LEU	4.3
2	G	368	ASP	4.3
4	L	91	SER	4.3

Continued on next page...

Continued from previous page...

Mol	Chain	Res	Type	RSRZ
4	R	110	LEU	4.3
2	G	269	GLU	4.3
4	R	109	VAL	4.2
4	K	180	SER	4.2
5	M	10	GLN	4.2
3	Q	177	THR	4.2
3	I	99	ASN	4.2
4	R	112	GLN	4.2
1	C	543	ASN	4.2
4	R	20	ALA	4.2
1	C	624	ASP	4.2
4	K	80	GLN	4.1
2	H	32	GLU	4.1
3	Q	178	SER	4.1
3	Q	172	ASN	4.1
2	F	498	PRO	4.1
2	G	364	SER	4.0
4	R	148	VAL	4.0
4	L	89	CYS	4.0
4	R	21	ARG	4.0
4	L	61	GLY	4.0
4	R	13	SER	4.0
5	M	110	THR	4.0
3	I	36	THR	4.0
3	I	59	THR	4.0
3	J	44	LYS	3.9
3	J	152	THR	3.9
2	F	219	ALA	3.9
5	M	82(B)	ARG	3.9
5	O	19	THR	3.9
6	N	25	GLY	3.9
5	M	112	SER	3.9
5	M	15	GLY	3.9
2	F	60	ALA	3.8
3	Q	43	GLY	3.8
3	I	50	GLY	3.8
4	R	173	ASN	3.8
3	I	71	GLU	3.8
5	O	17	SER	3.8
3	Q	56	GLY	3.8
4	K	114	ALA	3.8
5	D	7	SER	3.8

Continued on next page...

Continued from previous page...

Mol	Chain	Res	Type	RSRZ
2	H	221	ALA	3.8
2	H	33	ASN	3.8
5	M	82(C)	LEU	3.8
6	N	109	GLN	3.8
3	I	120	TRP	3.8
3	I	230	PRO	3.8
5	M	87	THR	3.8
2	F	220	PRO	3.8
6	N	13	GLY	3.8
2	G	39	TYR	3.8
4	R	40	LYS	3.7
2	G	36	VAL	3.7
4	R	108	THR	3.7
4	L	49	ILE	3.7
4	R	22	ILE	3.7
3	Q	208	THR	3.7
3	Q	58	THR	3.7
4	R	42	GLY	3.7
3	Q	205	SER	3.7
6	N	5	THR	3.7
4	R	215	CYS	3.7
4	R	124	PRO	3.6
5	O	42	GLY	3.6
3	J	42	PRO	3.6
4	R	111	GLY	3.6
6	P	31	ASP	3.6
4	K	117	PRO	3.6
5	O	18	VAL	3.6
1	C	618	ASN	3.6
1	B	547	GLY	3.6
6	N	37	GLN	3.6
6	N	106	VAL	3.6
3	Q	52	ILE	3.6
6	E	79	GLN	3.6
1	C	547	GLY	3.5
5	M	18	VAL	3.5
3	Q	159	VAL	3.5
6	E	12	SER	3.5
4	K	79	VAL	3.5
4	K	145	PRO	3.5
3	Q	49	ILE	3.5
2	H	34	LEU	3.5

Continued on next page...

Continued from previous page...

Mol	Chain	Res	Type	RSRZ
2	F	33	ASN	3.5
3	Q	155	LEU	3.5
2	H	94	ASN	3.5
5	D	9	ALA	3.5
5	D	82	LEU	3.4
3	Q	98	ARG	3.4
2	F	214	PRO	3.4
5	D	82(C)	LEU	3.4
3	I	63	SER	3.4
4	K	112	GLN	3.4
6	N	108	GLY	3.4
5	D	19	THR	3.4
4	L	43	GLN	3.3
6	N	12	SER	3.3
2	G	334	SER	3.3
3	Q	168	THR	3.3
4	L	32	ARG	3.3
6	N	27(A)	ARG	3.3
2	H	262	ASN	3.3
3	I	138	VAL	3.3
4	R	14	VAL	3.3
5	M	83	THR	3.3
3	I	34	SER	3.3
3	J	136	PRO	3.3
4	R	154	ALA	3.3
3	J	210	THR	3.3
2	H	395	TRP	3.2
5	O	90	TYR	3.2
2	F	500	ARG	3.2
2	G	471	GLY	3.2
5	M	84	SER	3.2
5	M	34	MET	3.2
3	J	50	GLY	3.2
3	J	207	GLY	3.2
5	D	21	SER	3.2
4	R	16	PRO	3.2
4	L	35	TYR	3.2
3	I	232	SER	3.2
2	F	497	ALA	3.2
4	K	147	ALA	3.2
4	R	76	ILE	3.2
3	I	157	CYS	3.1

Continued on next page...

Continued from previous page...

Mol	Chain	Res	Type	RSRZ
2	H	93	PHE	3.1
2	H	254	VAL	3.1
3	I	141	LEU	3.1
3	I	229	GLU	3.1
3	J	213	CYS	3.1
3	J	40	GLN	3.1
5	M	19	THR	3.1
3	J	122	GLN	3.1
6	E	20	THR	3.1
4	L	84	GLU	3.1
2	G	60	ALA	3.1
4	R	168	PRO	3.1
4	R	193	LYS	3.1
3	I	97	ALA	3.1
2	G	500	ARG	3.1
1	B	538	THR	3.1
4	R	136	LEU	3.1
4	R	41	PRO	3.0
5	M	33	HIS	3.0
4	L	101	PHE	3.0
4	R	17	GLY	3.0
4	K	202	GLU	3.0
1	C	664	ASP	3.0
3	Q	144	SER	3.0
2	G	37	THR	3.0
1	C	546	SER	3.0
3	J	145	SER	3.0
4	K	168	PRO	3.0
5	M	17	SER	3.0
2	G	398	ASN	3.0
3	Q	35	TRP	3.0
2	G	62	GLU	3.0
1	B	602	LEU	3.0
2	H	212	PRO	3.0
2	H	283	ASN	3.0
2	G	231	LYS	3.0
3	Q	201	VAL	3.0
2	G	499	THR	3.0
3	Q	164	PRO	3.0
2	H	497	ALA	3.0
3	Q	45	ALA	3.0
2	G	185	ASN	3.0

Continued on next page...

Continued from previous page...

Mol	Chain	Res	Type	RSRZ
4	R	39	GLN	3.0
4	K	83	ASP	3.0
3	Q	119	VAL	3.0
4	L	159	VAL	3.0
4	K	64	SER	3.0
3	J	78	ARG	2.9
5	M	94	ARG	2.9
4	R	145	PRO	2.9
1	A	594	GLY	2.9
3	Q	226	LYS	2.9
1	C	634	GLU	2.9
3	Q	146	LYS	2.9
1	A	664	ASP	2.9
2	H	495	GLY	2.9
3	I	226	LYS	2.9
4	R	78	GLY	2.9
3	Q	54	TYR	2.9
1	B	542	ARG	2.9
4	L	80	GLN	2.9
2	H	263	GLY	2.9
5	D	81	GLU	2.9
6	N	104	LEU	2.9
3	Q	211	TYR	2.9
3	Q	207	GLY	2.9
5	M	9	ALA	2.9
3	J	228	VAL	2.9
6	E	39	HIS	2.9
4	L	92	SER	2.9
6	N	78	LEU	2.9
5	O	43	ARG	2.9
2	F	93	PHE	2.9
4	R	61	GLY	2.9
4	L	48	ILE	2.9
3	Q	53	HIS	2.9
1	A	591	GLN	2.9
3	J	151	GLY	2.9
5	M	16	ALA	2.9
5	O	44	GLY	2.9
1	C	589	ASP	2.8
2	F	474	ASP	2.8
2	G	50	THR	2.8
3	J	51	ASP	2.8

Continued on next page...

Continued from previous page...

Mol	Chain	Res	Type	RSRZ
4	L	109	VAL	2.8
2	G	365	SER	2.8
3	Q	231	LYS	2.8
4	L	42	GLY	2.8
1	A	538	THR	2.8
1	C	585	ARG	2.8
3	J	208	THR	2.8
4	L	62	ARG	2.8
2	F	213	ILE	2.8
2	H	92	GLU	2.8
4	L	87	TYR	2.8
2	F	183	GLN	2.8
4	R	183	SER	2.8
4	R	103	GLY	2.8
6	P	12	SER	2.8
4	R	169	SER	2.8
2	G	232	LYS	2.8
2	G	396	ILE	2.8
3	Q	44	LYS	2.8
4	L	132	ASN	2.8
4	K	138	CYS	2.8
5	M	12	LYS	2.8
3	Q	47	GLU	2.7
4	K	113	PRO	2.7
4	R	155	ASP	2.7
6	N	81	GLU	2.7
2	G	444	ARG	2.7
4	L	174	ASN	2.7
2	F	499	THR	2.7
3	Q	137	SER	2.7
2	F	473	GLY	2.7
3	Q	97	ALA	2.7
5	M	88	ALA	2.7
3	I	37	TRP	2.7
2	G	386	ASN	2.7
5	O	109	VAL	2.7
2	G	279	ASN	2.7
3	J	226	LYS	2.7
4	L	30	THR	2.7
1	B	656	ASN	2.7
3	J	212	ILE	2.7
6	N	75	ILE	2.7

Continued on next page...

Continued from previous page...

Mol	Chain	Res	Type	RSRZ
6	P	33	VAL	2.7
2	H	59	LYS	2.7
3	J	35	TRP	2.7
1	B	603	ILE	2.7
3	J	215	VAL	2.7
5	M	111	VAL	2.7
3	J	37	TRP	2.7
2	G	425	ASN	2.7
2	F	54	CYS	2.7
5	D	100(D)	SER	2.7
6	N	24	ALA	2.7
2	F	71	THR	2.7
4	K	146	GLY	2.7
4	K	181	TYR	2.7
2	G	34	LEU	2.7
1	B	519	PHE	2.6
4	R	77	ARG	2.7
1	C	625	ASN	2.6
3	J	146	LYS	2.6
3	Q	174	GLY	2.6
4	K	103	GLY	2.6
6	N	105	THR	2.6
3	J	209	GLN	2.6
5	M	4	LEU	2.6
4	K	163	VAL	2.6
5	O	12	LYS	2.6
2	H	396	ILE	2.6
6	N	26	SER	2.6
4	R	157	SER	2.6
3	I	27	ASP	2.6
4	K	43	GLN	2.6
2	F	356	ASN	2.6
3	I	154	ALA	2.6
2	G	367	GLY	2.6
2	G	504	ARG	2.6
2	F	283	ASN	2.6
3	Q	131	ALA	2.6
3	I	145	SER	2.6
4	R	75	THR	2.6
5	D	15	GLY	2.6
2	H	237	GLY	2.6
3	I	116	GLY	2.6

Continued on next page...

Continued from previous page...

Mol	Chain	Res	Type	RSRZ
2	H	504	ARG	2.6
2	H	60	ALA	2.6
1	C	544	LEU	2.5
1	B	532	ALA	2.5
2	F	218	CYS	2.5
3	Q	105	GLY	2.5
2	H	290	THR	2.5
5	O	82(A)	SER	2.5
6	E	40	PRO	2.5
1	C	590	GLN	2.5
1	B	642	ILE	2.5
5	M	3	GLN	2.5
2	F	190	GLU	2.5
3	Q	154	ALA	2.5
3	Q	228	VAL	2.5
4	K	174	ASN	2.5
5	D	12	LYS	2.5
2	G	220	PRO	2.5
2	H	236	THR	2.5
3	J	10	GLY	2.5
3	Q	79	PHE	2.5
4	K	135	THR	2.5
4	L	46	VAL	2.5
4	R	158	PRO	2.5
3	Q	37	TRP	2.5
2	G	283	ASN	2.5
2	G	213	ILE	2.5
3	I	49	ILE	2.5
4	L	64	SER	2.5
2	H	128	THR	2.5
5	M	82	LEU	2.5
1	C	601	LYS	2.5
3	Q	195	LEU	2.5
4	K	148	VAL	2.5
1	B	543	ASN	2.5
2	F	189	LYS	2.5
3	I	231	LYS	2.5
3	Q	133	THR	2.5
2	H	478	ASN	2.5
3	Q	19	SER	2.5
2	F	395	TRP	2.5
3	Q	138	VAL	2.5

Continued on next page...

Continued from previous page...

Mol	Chain	Res	Type	RSRZ
1	C	652	GLN	2.4
4	R	146	GLY	2.4
6	E	19	ILE	2.4
4	L	107	LEU	2.4
2	G	189	LYS	2.4
3	J	229	GLU	2.4
3	Q	72	LEU	2.4
1	B	622	ILE	2.4
4	K	136	LEU	2.4
2	G	128	THR	2.4
3	I	139	PHE	2.4
3	J	172	ASN	2.4
3	I	142	ALA	2.4
5	D	68	SER	2.4
3	Q	184	PRO	2.4
5	M	11	VAL	2.4
6	N	86	TYR	2.4
2	F	90	THR	2.4
2	F	238	PRO	2.4
4	L	65	ALA	2.4
6	N	29	GLY	2.4
2	H	71	THR	2.4
3	J	52	ILE	2.4
5	M	13	LYS	2.4
3	I	136	PRO	2.4
4	R	107	LEU	2.4
2	H	31	ALA	2.4
5	M	14	PRO	2.4
2	H	235	GLY	2.4
5	O	80	MET	2.4
1	C	545	LEU	2.4
2	G	230	ASP	2.4
2	H	70	ALA	2.3
3	Q	221	ASN	2.3
5	D	79	TYR	2.3
3	Q	18	LEU	2.3
6	P	11	VAL	2.3
3	J	143	PRO	2.3
3	J	36	THR	2.3
5	M	85	ASP	2.3
6	P	22	SER	2.3
5	D	46	GLU	2.3

Continued on next page...

Continued from previous page...

Mol	Chain	Res	Type	RSRZ
1	A	599	SER	2.3
2	G	38	VAL	2.3
6	E	77	GLY	2.3
2	F	91	GLU	2.3
1	A	600	GLY	2.3
2	H	39	TYR	2.3
2	F	487	LYS	2.3
2	G	63	THR	2.3
3	Q	206	LEU	2.3
2	F	61	TYR	2.3
3	Q	36	THR	2.3
5	D	14	PRO	2.3
2	G	472	GLY	2.3
1	B	601	LYS	2.3
2	F	59	LYS	2.3
2	H	77	THR	2.3
4	K	152	TRP	2.3
2	H	238	PRO	2.3
3	J	137	SER	2.3
3	I	38	VAL	2.3
3	Q	171	TRP	2.3
6	N	19	ILE	2.3
2	F	252	LYS	2.3
4	L	38	ARG	2.3
4	K	165	THR	2.3
4	L	44	ALA	2.2
4	K	84	GLU	2.2
4	L	63	PHE	2.2
4	L	112	GLN	2.2
3	J	70	ILE	2.2
4	L	28	PRO	2.2
2	G	88	ASN	2.2
4	K	119	VAL	2.2
2	F	56	SER	2.2
2	H	187	SER	2.2
3	J	123	GLY	2.2
3	Q	219	PRO	2.2
3	Q	196	SER	2.2
4	R	11	SER	2.2
2	H	496	VAL	2.2
3	Q	77	PRO	2.2
2	H	256	SER	2.2

Continued on next page...

Continued from previous page...

Mol	Chain	Res	Type	RSRZ
6	N	77	GLY	2.2
3	Q	182	THR	2.2
4	K	109	VAL	2.2
4	R	79	VAL	2.2
3	I	211	TYR	2.2
5	D	67	VAL	2.2
4	R	162	GLY	2.2
2	H	359	ILE	2.2
3	I	146	LYS	2.2
3	J	164	PRO	2.2
5	M	108	LEU	2.2
3	J	138	VAL	2.2
3	Q	202	PRO	2.2
4	K	75	THR	2.2
4	K	144	TYR	2.2
4	R	184	LEU	2.2
3	I	48	TRP	2.2
6	P	21	ILE	2.2
1	B	621	GLU	2.2
1	B	618	ASN	2.2
2	F	394	THR	2.2
3	J	11	LEU	2.2
3	J	224	VAL	2.2
6	P	47	ILE	2.2
5	M	24	ALA	2.2
5	M	100(H)	GLY	2.2
2	H	358	ILE	2.2
5	D	18	VAL	2.2
5	O	82	LEU	2.1
2	H	67	ASN	2.1
4	R	10	PRO	2.1
3	J	58	THR	2.1
2	G	43	PRO	2.1
2	H	368	ASP	2.1
4	K	156	SER	2.1
6	P	13	GLY	2.1
2	G	487	LYS	2.1
4	L	148	VAL	2.1
2	H	321(A)	ASP	2.1
4	R	196	SER	2.1
2	G	49	GLU	2.1
1	B	664	ASP	2.1

Continued on next page...

Continued from previous page...

Mol	Chain	Res	Type	RSRZ
4	R	182	LEU	2.1
4	L	88	TYR	2.1
4	R	19	THR	2.1
2	H	253	PRO	2.1
5	D	100	SER	2.1
6	P	92	ALA	2.1
3	J	227	ARG	2.1
4	L	81	ALA	2.1
3	Q	50	GLY	2.1
4	L	78	GLY	2.1
4	R	43	GLN	2.1
2	F	191	TYR	2.1
1	C	540	GLN	2.1
3	J	230	PRO	2.1
6	E	21	ILE	2.1
4	R	210	VAL	2.1
1	B	619	LEU	2.1
2	G	190	GLU	2.1
4	L	202	GLU	2.1
3	I	98	ARG	2.1
2	F	505	VAL	2.1
1	C	623	TRP	2.1
5	O	20	VAL	2.0
2	G	271	MET	2.0
1	C	599	SER	2.0
2	G	495	GLY	2.0
4	R	15	SER	2.0
6	N	47	ILE	2.0
2	H	332	ASN	2.0
4	L	82	ASP	2.0
5	O	69	MET	2.0
3	Q	41	SER	2.0
3	Q	90	ASP	2.0
4	L	158	PRO	2.0
5	M	52(A)	PRO	2.0
4	R	164	GLU	2.0
3	Q	200	THR	2.0
3	J	59	THR	2.0
3	Q	199	VAL	2.0
4	K	209	THR	2.0
1	C	659	ASP	2.0
6	P	19	ILE	2.0

Continued on next page...

Continued from previous page...

Mol	Chain	Res	Type	RSRZ
3	Q	103	ILE	2.0
3	Q	209	GLN	2.0
2	F	357	THR	2.0
2	G	268	GLU	2.0

6.2 Non-standard residues in protein, DNA, RNA chains [i](#)

There are no non-standard protein/DNA/RNA residues in this entry.

6.3 Carbohydrates [i](#)

There are no monosaccharides in this entry.

6.4 Ligands [i](#)

There are no ligands in this entry.

6.5 Other polymers [i](#)

There are no such residues in this entry.