



# Full wwPDB X-ray Structure Validation Report ⓘ

Nov 7, 2023 – 10:44 AM EST

PDB ID : 5TI9  
Title : Crystal structure of human TDO in complex with Trp and dioxygen, Northeast Structural Genomics Consortium Target HR6161  
Authors : Forouhar, F.; Lewis-Ballester, A.; Lew, S.; Karkashon, S.; Seetharaman, J.; Yeh, S.R.; Tong, L.  
Deposited on : 2016-10-01  
Resolution : 2.50 Å(reported)

This is a Full wwPDB X-ray Structure Validation Report for a publicly released PDB entry.

We welcome your comments at [validation@mail.wwpdb.org](mailto:validation@mail.wwpdb.org)

A user guide is available at

<https://www.wwpdb.org/validation/2017/XrayValidationReportHelp>

with specific help available everywhere you see the ⓘ symbol.

The types of validation reports are described at

<http://www.wwpdb.org/validation/2017/FAQs#types>.

---

The following versions of software and data (see [references ⓘ](#)) were used in the production of this report:

MolProbity : 4.02b-467  
Mogul : 1.8.5 (274361), CSD as541be (2020)  
Xtriage (Phenix) : 1.13  
EDS : 2.36  
buster-report : 1.1.7 (2018)  
Percentile statistics : 20191225.v01 (using entries in the PDB archive December 25th 2019)  
Refmac : 5.8.0158  
CCP4 : 7.0.044 (Gargrove)  
Ideal geometry (proteins) : Engh & Huber (2001)  
Ideal geometry (DNA, RNA) : Parkinson et al. (1996)  
Validation Pipeline (wwPDB-VP) : 2.36

# 1 Overall quality at a glance i

The following experimental techniques were used to determine the structure:

*X-RAY DIFFRACTION*

The reported resolution of this entry is 2.50 Å.

Percentile scores (ranging between 0-100) for global validation metrics of the entry are shown in the following graphic. The table shows the number of entries on which the scores are based.

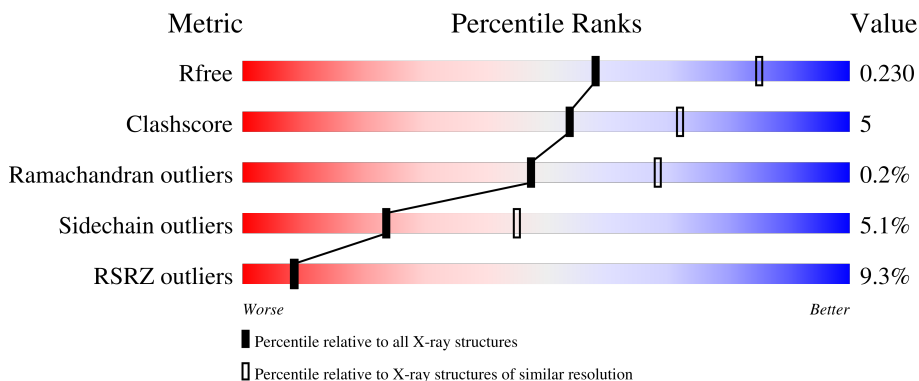

Metric	Whole archive (#Entries)	Similar resolution (#Entries, resolution range(Å))
$R_{free}$	130704	4661 (2.50-2.50)
Clashscore	141614	5346 (2.50-2.50)
Ramachandran outliers	138981	5231 (2.50-2.50)
Sidechain outliers	138945	5233 (2.50-2.50)
RSRZ outliers	127900	4559 (2.50-2.50)

The table below summarises the geometric issues observed across the polymeric chains and their fit to the electron density. The red, orange, yellow and green segments of the lower bar indicate the fraction of residues that contain outliers for  $\geq 3$ , 2, 1 and 0 types of geometric quality criteria respectively. A grey segment represents the fraction of residues that are not modelled. The numeric value for each fraction is indicated below the corresponding segment, with a dot representing fractions  $\leq 5\%$ . The upper red bar (where present) indicates the fraction of residues that have poor fit to the electron density. The numeric value is given above the bar.

Mol	Chain	Length	Quality of chain
1	A	380	 9% 80% 11% • 8%
1	B	380	 6% 75% 12% • 12%
1	C	380	 13% 68% 16% • 14%
1	D	380	 6% 74% 13% • 13%

## 2 Entry composition [i](#)

There are 7 unique types of molecules in this entry. The entry contains 12070 atoms, of which 0 are hydrogens and 0 are deuteriums.

In the tables below, the ZeroOcc column contains the number of atoms modelled with zero occupancy, the AltConf column contains the number of residues with at least one atom in alternate conformation and the Trace column contains the number of residues modelled with at most 2 atoms.

- Molecule 1 is a protein called Tryptophan 2,3-dioxygenase.

Mol	Chain	Residues	Atoms					ZeroOcc	AltConf	Trace
			Total	C	N	O	S			
1	A	350	2948	1891	518	528	11	0	0	0
1	B	336	2814	1803	491	509	11	0	0	0
1	C	326	2744	1768	480	486	10	0	0	0
1	D	332	2818	1811	495	501	11	0	0	0

There are 32 discrepancies between the modelled and reference sequences:

Chain	Residue	Modelled	Actual	Comment	Reference
A	17	MET	-	initiating methionine	UNP P48775
A	390	GLU	-	expression tag	UNP P48775
A	391	HIS	-	expression tag	UNP P48775
A	392	HIS	-	expression tag	UNP P48775
A	393	HIS	-	expression tag	UNP P48775
A	394	HIS	-	expression tag	UNP P48775
A	395	HIS	-	expression tag	UNP P48775
A	396	HIS	-	expression tag	UNP P48775
B	17	MET	-	initiating methionine	UNP P48775
B	390	GLU	-	expression tag	UNP P48775
B	391	HIS	-	expression tag	UNP P48775
B	392	HIS	-	expression tag	UNP P48775
B	393	HIS	-	expression tag	UNP P48775
B	394	HIS	-	expression tag	UNP P48775
B	395	HIS	-	expression tag	UNP P48775
B	396	HIS	-	expression tag	UNP P48775
C	17	MET	-	initiating methionine	UNP P48775
C	390	GLU	-	expression tag	UNP P48775
C	391	HIS	-	expression tag	UNP P48775
C	392	HIS	-	expression tag	UNP P48775
C	393	HIS	-	expression tag	UNP P48775

*Continued on next page...*

Continued from previous page...

Chain	Residue	Modelled	Actual	Comment	Reference
C	394	HIS	-	expression tag	UNP P48775
C	395	HIS	-	expression tag	UNP P48775
C	396	HIS	-	expression tag	UNP P48775
D	17	MET	-	initiating methionine	UNP P48775
D	390	GLU	-	expression tag	UNP P48775
D	391	HIS	-	expression tag	UNP P48775
D	392	HIS	-	expression tag	UNP P48775
D	393	HIS	-	expression tag	UNP P48775
D	394	HIS	-	expression tag	UNP P48775
D	395	HIS	-	expression tag	UNP P48775
D	396	HIS	-	expression tag	UNP P48775

- Molecule 2 is OXYGEN MOLECULE (three-letter code: OXY) (formula: O<sub>2</sub>).

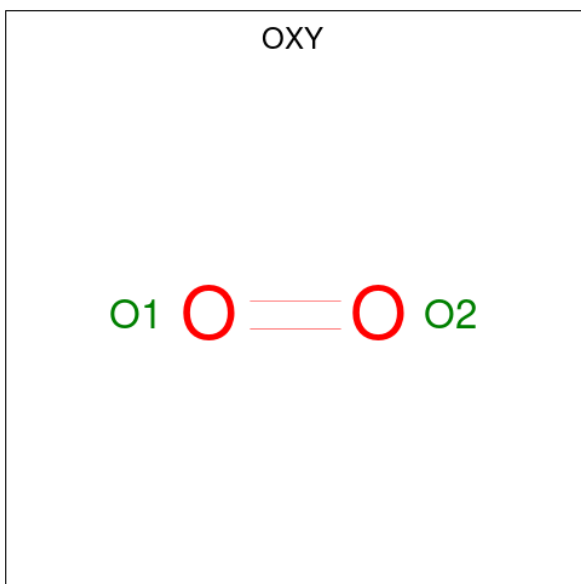

Mol	Chain	Residues	Atoms	ZeroOcc	AltConf
2	A	1	Total O 2 2	0	0
2	B	1	Total O 2 2	0	0

- Molecule 3 is PROTOPORPHYRIN IX CONTAINING FE (three-letter code: HEM) (formula: C<sub>34</sub>H<sub>32</sub>FeN<sub>4</sub>O<sub>4</sub>).

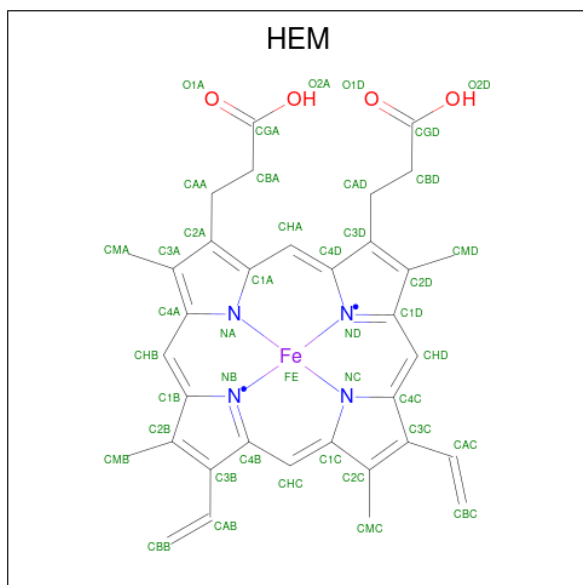

Mol	Chain	Residues	Atoms				ZeroOcc	AltConf	
			Total	C	Fe	N			O
3	A	1	Total 43	C 34	Fe 1	N 4	O 4	0	0
3	B	1	Total 43	C 34	Fe 1	N 4	O 4	0	0
3	C	1	Total 43	C 34	Fe 1	N 4	O 4	0	0
3	D	1	Total 43	C 34	Fe 1	N 4	O 4	0	0

- Molecule 4 is TRYPTOPHAN (three-letter code: TRP) (formula:  $C_{11}H_{12}N_2O_2$ ).

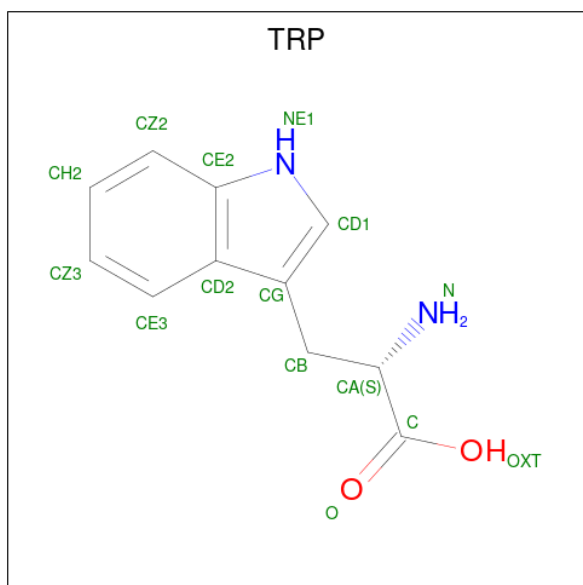

Mol	Chain	Residues	Atoms				ZeroOcc	AltConf
4	A	1	Total	C	N	O	0	0
			15	11	2	2		
4	A	1	Total	C	N	O	0	0
			15	11	2	2		
4	B	1	Total	C	N	O	0	0
			15	11	2	2		
4	B	1	Total	C	N	O	0	0
			15	11	2	2		
4	C	1	Total	C	N	O	0	0
			15	11	2	2		
4	D	1	Total	C	N	O	0	0
			15	11	2	2		

- Molecule 5 is PHOSPHATE ION (three-letter code: PO4) (formula: O<sub>4</sub>P).

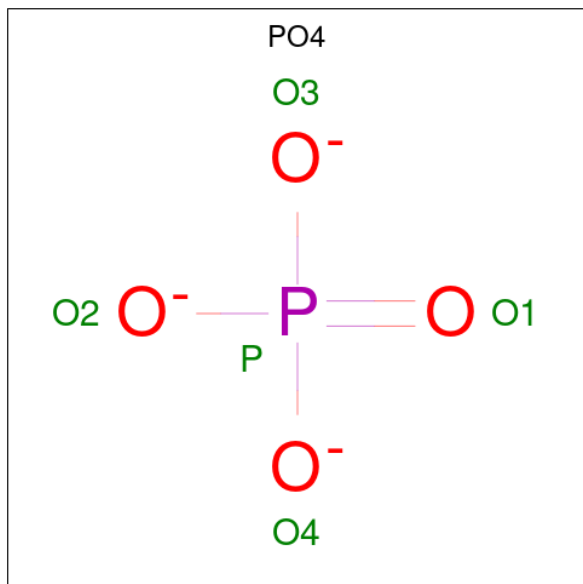

Mol	Chain	Residues	Atoms			ZeroOcc	AltConf
5	A	1	Total	O	P	0	0
			5	4	1		
5	B	1	Total	O	P	0	0
			5	4	1		

- Molecule 6 is N<sup>1</sup>-Formylkynurenine (three-letter code: NFK) (formula: C<sub>11</sub>H<sub>12</sub>N<sub>2</sub>O<sub>4</sub>).

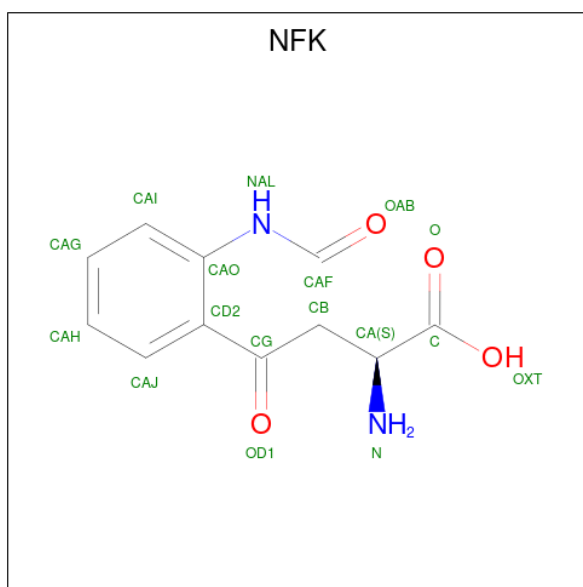

Mol	Chain	Residues	Atoms				ZeroOcc	AltConf
6	C	1	Total	C	N	O	0	0
			17	11	2	4		
6	D	1	Total	C	N	O	0	0
			17	11	2	4		

- Molecule 7 is water.

Mol	Chain	Residues	Atoms		ZeroOcc	AltConf
7	A	108	Total	O	0	0
			108	108		
7	B	134	Total	O	0	0
			134	134		
7	C	81	Total	O	0	0
			81	81		
7	D	113	Total	O	0	0
			113	113		

### 3 Residue-property plots [i](#)

These plots are drawn for all protein, RNA, DNA and oligosaccharide chains in the entry. The first graphic for a chain summarises the proportions of the various outlier classes displayed in the second graphic. The second graphic shows the sequence view annotated by issues in geometry and electron density. Residues are color-coded according to the number of geometric quality criteria for which they contain at least one outlier: green = 0, yellow = 1, orange = 2 and red = 3 or more. A red dot above a residue indicates a poor fit to the electron density ( $RSRZ > 2$ ). Stretches of 2 or more consecutive residues without any outlier are shown as a green connector. Residues present in the sample, but not in the model, are shown in grey.

- Molecule 1: Tryptophan 2,3-dioxygenase

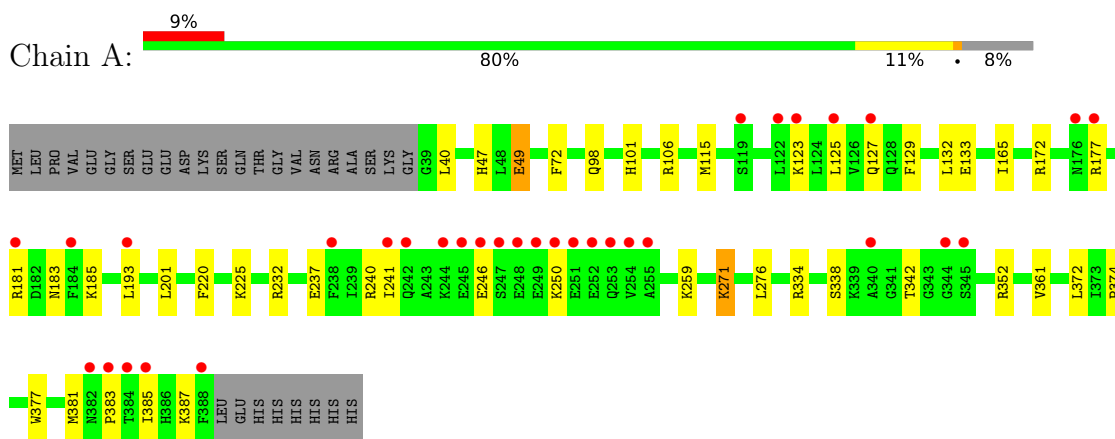

- Molecule 1: Tryptophan 2,3-dioxygenase

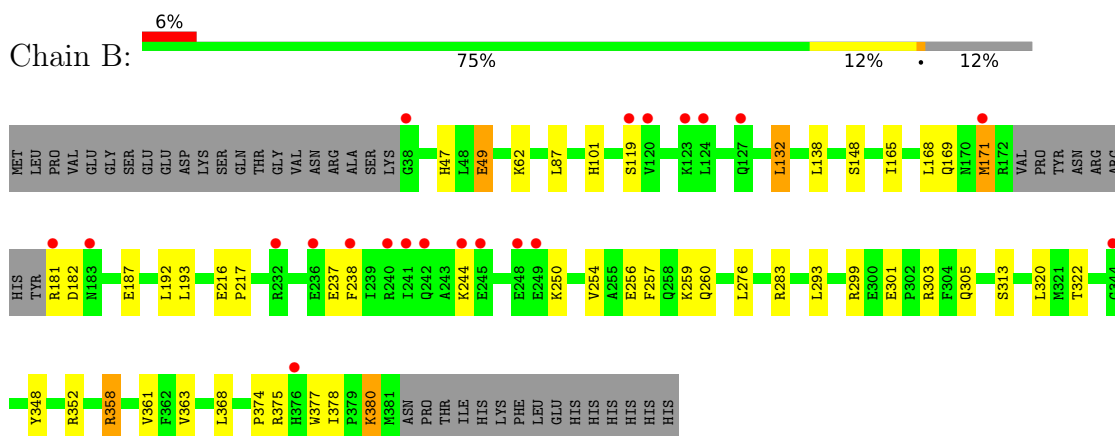

- Molecule 1: Tryptophan 2,3-dioxygenase

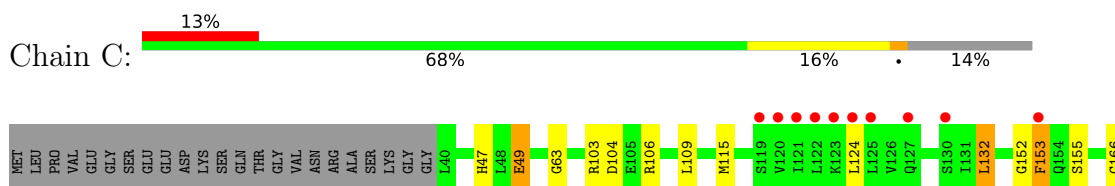



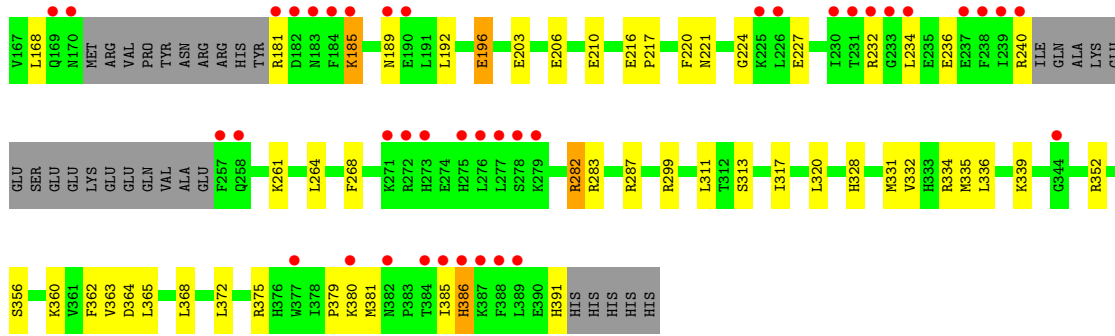

• Molecule 1: Tryptophan 2,3-dioxygenase

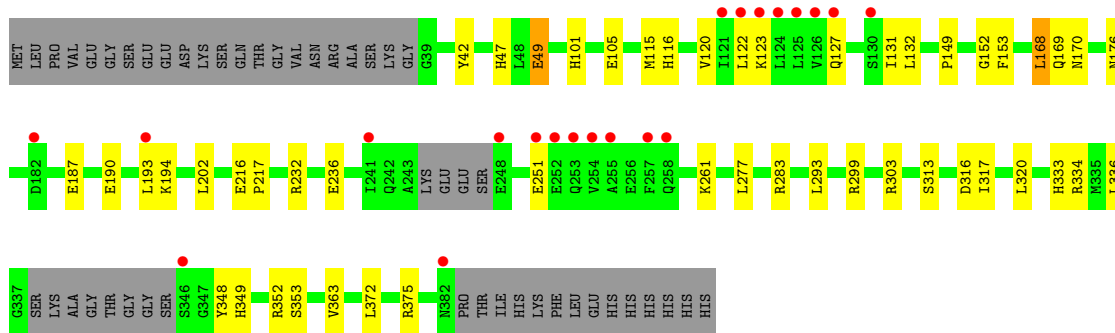
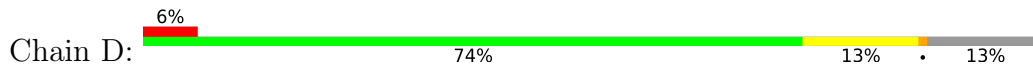

## 4 Data and refinement statistics

Property	Value	Source
Space group	P 21 21 2	Depositor
Cell constants a, b, c, $\alpha$ , $\beta$ , $\gamma$	143.60Å 154.01Å 87.80Å 90.00° 90.00° 90.00°	Depositor
Resolution (Å)	33.93 – 2.50 48.34 – 2.50	Depositor EDS
% Data completeness (in resolution range)	99.6 (33.93-2.50) 99.7 (48.34-2.50)	Depositor EDS
$R_{merge}$	0.06	Depositor
$R_{sym}$	0.04	Depositor
$\langle I/\sigma(I) \rangle$ <sup>1</sup>	2.92 (at 2.48Å)	Xtrriage
Refinement program	PHENIX 1.9_1692	Depositor
R, $R_{free}$	0.159 , 0.230 0.164 , 0.230	Depositor DCC
$R_{free}$ test set	6892 reflections (10.09%)	wwPDB-VP
Wilson B-factor (Å <sup>2</sup> )	45.4	Xtrriage
Anisotropy	0.259	Xtrriage
Bulk solvent $k_{sol}$ (e/Å <sup>3</sup> ), $B_{sol}$ (Å <sup>2</sup> )	0.35 , 69.4	EDS
L-test for twinning <sup>2</sup>	$\langle  L  \rangle = 0.50$ , $\langle L^2 \rangle = 0.33$	Xtrriage
Estimated twinning fraction	No twinning to report.	Xtrriage
$F_o, F_c$ correlation	0.96	EDS
Total number of atoms	12070	wwPDB-VP
Average B, all atoms (Å <sup>2</sup> )	56.0	wwPDB-VP

Xtrriage's analysis on translational NCS is as follows: *The largest off-origin peak in the Patterson function is 3.10% of the height of the origin peak. No significant pseudotranslation is detected.*

<sup>1</sup>Intensities estimated from amplitudes.

<sup>2</sup>Theoretical values of  $\langle |L| \rangle$ ,  $\langle L^2 \rangle$  for acentric reflections are 0.5, 0.333 respectively for untwinned datasets, and 0.375, 0.2 for perfectly twinned datasets.

## 5 Model quality [i](#)

### 5.1 Standard geometry [i](#)

Bond lengths and bond angles in the following residue types are not validated in this section: HEM, PO4, OXY, NFK

The Z score for a bond length (or angle) is the number of standard deviations the observed value is removed from the expected value. A bond length (or angle) with  $|Z| > 5$  is considered an outlier worth inspection. RMSZ is the root-mean-square of all Z scores of the bond lengths (or angles).

Mol	Chain	Bond lengths		Bond angles	
		RMSZ	# Z  >5	RMSZ	# Z  >5
1	A	0.53	0/3017	0.63	0/4060
1	B	0.53	0/2875	0.65	0/3864
1	C	0.48	0/2808	0.60	0/3778
1	D	0.51	0/2882	0.63	0/3877
All	All	0.51	0/11582	0.63	0/15579

There are no bond length outliers.

There are no bond angle outliers.

There are no chirality outliers.

There are no planarity outliers.

### 5.2 Too-close contacts [i](#)

In the following table, the Non-H and H(model) columns list the number of non-hydrogen atoms and hydrogen atoms in the chain respectively. The H(added) column lists the number of hydrogen atoms added and optimized by MolProbity. The Clashes column lists the number of clashes within the asymmetric unit, whereas Symm-Clashes lists symmetry-related clashes.

Mol	Chain	Non-H	H(model)	H(added)	Clashes	Symm-Clashes
1	A	2948	0	2933	21	0
1	B	2814	0	2802	29	0
1	C	2744	0	2738	47	0
1	D	2818	0	2803	26	0
2	A	2	0	0	1	0
2	B	2	0	0	0	0
3	A	43	0	30	1	0
3	B	43	0	30	1	0
3	C	43	0	30	3	0

*Continued on next page...*

Continued from previous page...

Mol	Chain	Non-H	H(model)	H(added)	Clashes	Symm-Clashes
3	D	43	0	30	2	0
4	A	30	0	18	4	0
4	B	30	0	18	0	0
4	C	15	0	9	0	0
4	D	15	0	9	1	0
5	A	5	0	0	0	0
5	B	5	0	0	0	0
6	C	17	0	0	1	0
6	D	17	0	0	2	0
7	A	108	0	0	3	0
7	B	134	0	0	3	0
7	C	81	0	0	4	0
7	D	113	0	0	2	0
All	All	12070	0	11450	122	0

The all-atom clashscore is defined as the number of clashes found per 1000 atoms (including hydrogen atoms). The all-atom clashscore for this structure is 5.

All (122) close contacts within the same asymmetric unit are listed below, sorted by their clash magnitude.

Atom-1	Atom-2	Interatomic distance (Å)	Clash overlap (Å)
1:C:166:GLY:O	1:C:283:ARG:NH2	2.10	0.83
1:A:172:ARG:HB2	1:A:177:ARG:HB3	1.68	0.75
1:C:339:LYS:O	7:C:501:HOH:O	2.11	0.69
1:C:234:LEU:HD13	1:C:261:LYS:HG3	1.74	0.68
1:D:261:LYS:NZ	7:D:501:HOH:O	2.29	0.66
1:C:63:GLY:O	7:C:502:HOH:O	2.14	0.66
1:C:221:ASN:HD21	1:C:224:GLY:HA3	1.63	0.62
1:C:299:ARG:HH12	1:C:375:ARG:NH2	1.96	0.62
1:A:237:GLU:OE2	1:A:240:ARG:NH1	2.35	0.60
1:B:299:ARG:HH22	1:B:375:ARG:HH22	1.50	0.59
1:D:47:HIS:HA	1:D:49:GLU:OE1	2.02	0.59
1:B:358:ARG:HD3	1:B:358:ARG:H	1.67	0.59
1:C:334:ARG:HD2	7:C:563:HOH:O	2.04	0.57
1:D:299:ARG:HH12	1:D:375:ARG:HH22	1.53	0.57
1:B:305:GLN:HG2	1:C:109:LEU:HB2	1.88	0.56
3:C:401:HEM:HMB1	3:C:401:HEM:HBB2	1.87	0.56
1:D:334:ARG:HD2	7:D:582:HOH:O	2.06	0.56
1:B:303:ARG:HG2	1:C:391:HIS:HB2	1.87	0.56
1:B:62:LYS:NZ	7:B:502:HOH:O	2.40	0.55
1:B:348:TYR:OH	1:B:352:ARG:NH2	2.41	0.54

Continued on next page...

*Continued from previous page...*

Atom-1	Atom-2	Interatomic distance (Å)	Clash overlap (Å)
1:C:47:HIS:HA	1:C:49:GLU:OE1	2.07	0.54
1:D:333:HIS:HB2	1:D:348:TYR:HE2	1.72	0.54
1:C:103:ARG:NH2	7:C:503:HOH:O	2.39	0.54
1:C:210:GLU:HG2	1:C:287:ARG:HB3	1.90	0.54
1:B:168:LEU:HG	1:B:283:ARG:NH1	2.23	0.54
1:C:381:MET:HB3	1:C:386:HIS:CE1	2.42	0.53
1:A:47:HIS:HA	1:A:49:GLU:OE1	2.09	0.53
1:C:104:ASP:OD2	1:C:106:ARG:HG2	2.09	0.53
1:D:105:GLU:OE2	4:D:403:TRP:N	2.43	0.52
1:D:299:ARG:HH12	1:D:375:ARG:NH2	2.06	0.52
1:D:105:GLU:OE1	1:D:303:ARG:HD2	2.10	0.52
1:C:328:HIS:O	1:C:332:VAL:HG23	2.10	0.52
1:C:234:LEU:HD21	1:C:264:LEU:HD12	1.92	0.51
1:D:152:GLY:H	6:D:402:NFK:CAF	2.23	0.51
1:A:98:GLN:NE2	7:A:501:HOH:O	2.41	0.51
1:A:246:GLU:HA	1:A:250:LYS:HD3	1.92	0.51
1:C:362:PHE:HB3	1:C:365:LEU:HD12	1.92	0.51
1:D:152:GLY:HA3	3:D:401:HEM:C1D	2.46	0.50
1:B:132:LEU:HD13	3:B:402:HEM:HAB	1.94	0.50
1:C:185:LYS:HA	1:C:189:ASN:HB2	1.93	0.50
1:B:358:ARG:NH1	7:B:504:HOH:O	2.44	0.50
1:A:123:LYS:O	1:A:127:GLN:HG3	2.12	0.49
1:C:220:PHE:CD2	1:C:385:ILE:HG13	2.47	0.49
1:B:256:GLU:O	1:B:260:GLN:HG2	2.13	0.49
1:C:181:ARG:HG3	1:C:192:LEU:HD23	1.94	0.49
1:D:123:LYS:O	1:D:127:GLN:HG3	2.13	0.49
1:B:165:ILE:HG22	1:B:361:VAL:HG21	1.94	0.48
1:A:271:LYS:HD2	1:A:271:LYS:N	2.28	0.47
3:D:401:HEM:HBC2	3:D:401:HEM:HHD	1.96	0.47
1:C:132:LEU:HB3	1:C:331:MET:CE	2.44	0.47
1:B:375:ARG:HA	1:B:378:ILE:HD12	1.97	0.47
3:A:402:HEM:HMB1	3:A:402:HEM:HBB2	1.96	0.47
1:C:299:ARG:HH12	1:C:375:ARG:HH22	1.61	0.47
1:A:374:PRO:HG2	1:A:377:TRP:CE2	2.49	0.47
1:C:168:LEU:HD23	1:C:168:LEU:HA	1.60	0.47
1:B:216:GLU:HA	1:B:217:PRO:HD3	1.73	0.46
1:B:47:HIS:ND1	1:B:49:GLU:OE1	2.46	0.46
1:D:333:HIS:HB2	1:D:348:TYR:CE2	2.51	0.46
1:A:106:ARG:NH1	7:A:507:HOH:O	2.49	0.46
1:C:227:GLU:HB2	1:C:268:PHE:CE1	2.50	0.46
1:A:383:PRO:O	1:A:387:LYS:HG3	2.16	0.45

*Continued on next page...*

*Continued from previous page...*

Atom-1	Atom-2	Interatomic distance (Å)	Clash overlap (Å)
1:A:115:MET:HE2	1:A:201:LEU:HD21	1.99	0.45
1:D:169:GLN:HG3	1:D:170:ASN:N	2.32	0.45
1:B:168:LEU:HD23	1:B:168:LEU:HA	1.63	0.45
1:B:250:LYS:O	1:B:254:VAL:HG23	2.17	0.45
2:A:401:OXY:O1	4:A:403:TRP:NE1	2.49	0.44
1:C:360:LYS:HB3	1:C:363:VAL:HG13	1.99	0.44
1:A:165:ILE:HG22	1:A:361:VAL:HG21	2.00	0.44
1:C:282:ARG:HG3	1:C:364:ASP:OD1	2.17	0.44
1:A:352:ARG:HH11	1:C:356:SER:HA	1.82	0.44
1:C:132:LEU:HB3	1:C:331:MET:HE1	2.00	0.44
1:D:232:ARG:O	1:D:236:GLU:HG3	2.18	0.44
1:C:181:ARG:NH1	1:C:196:GLU:OE1	2.51	0.43
1:B:87:LEU:HD23	1:B:87:LEU:HA	1.77	0.43
1:C:216:GLU:HA	1:C:217:PRO:HD3	1.76	0.43
1:D:116:HIS:O	1:D:120:VAL:HG23	2.18	0.43
1:D:293:LEU:HD12	1:D:293:LEU:HA	1.83	0.43
1:A:220:PHE:O	1:A:225:LYS:NZ	2.43	0.43
1:B:216:GLU:H	1:B:216:GLU:CD	2.21	0.43
1:D:152:GLY:N	6:D:402:NFK:CAF	2.82	0.43
1:A:276:LEU:HD23	1:A:276:LEU:HA	1.78	0.43
1:D:313:SER:O	1:D:316:ASP:HB2	2.18	0.43
4:A:404:TRP:N	7:A:508:HOH:O	2.51	0.43
1:B:380:LYS:HD2	1:B:380:LYS:H	1.84	0.43
1:B:374:PRO:HG2	1:B:377:TRP:CE2	2.54	0.42
1:C:368:LEU:HD23	1:C:368:LEU:HA	1.88	0.42
1:B:301:GLU:OE1	1:C:106:ARG:NH1	2.53	0.42
1:D:168:LEU:HD12	1:D:168:LEU:HA	1.67	0.42
1:A:72:PHE:HZ	4:A:403:TRP:CD1	2.38	0.42
1:A:377:TRP:N	1:A:377:TRP:CD1	2.87	0.42
1:C:115:MET:HE3	1:C:317:ILE:CD1	2.50	0.42
1:C:203:GLU:O	1:C:206:GLU:HB3	2.20	0.42
1:C:311:LEU:HD23	1:C:311:LEU:HA	1.79	0.42
1:A:342:THR:HG23	4:A:403:TRP:O	2.20	0.42
1:C:335:MET:HG3	3:C:401:HEM:CBB	2.50	0.42
1:C:155:SER:HB2	1:D:42:TYR:CE1	2.55	0.42
1:B:276:LEU:HD23	1:B:276:LEU:HA	1.83	0.42
1:C:124:LEU:HD22	1:D:131:ILE:HD11	2.02	0.42
1:D:216:GLU:HA	1:D:217:PRO:HD3	1.74	0.42
1:B:260:GLN:OE1	7:B:501:HOH:O	2.21	0.41
1:C:220:PHE:HD2	1:C:385:ILE:HG13	1.85	0.41
1:C:381:MET:HB3	1:C:386:HIS:ND1	2.35	0.41

*Continued on next page...*

Continued from previous page...

Atom-1	Atom-2	Interatomic distance (Å)	Clash overlap (Å)
1:C:49:GLU:H	1:C:49:GLU:HG3	1.49	0.41
1:D:115:MET:HE3	1:D:317:ILE:CD1	2.51	0.41
1:C:132:LEU:HD23	1:C:132:LEU:HA	1.92	0.41
1:C:232:ARG:HG2	1:C:236:GLU:OE1	2.20	0.41
1:D:122:LEU:HB3	1:D:320:LEU:HB3	2.02	0.41
1:C:153:PHE:CE1	3:C:401:HEM:HBA1	2.56	0.41
1:A:259:LYS:HA	1:A:259:LYS:HD2	1.84	0.41
1:D:202:LEU:HD21	1:D:283:ARG:HB3	2.03	0.41
1:A:129:PHE:O	1:A:133:GLU:HG3	2.21	0.41
1:B:181:ARG:HH11	1:B:193:LEU:HD21	1.86	0.41
1:B:238:PHE:HB2	1:B:257:PHE:CZ	2.56	0.41
1:D:123:LYS:HE3	1:D:123:LYS:HB2	1.81	0.41
1:B:181:ARG:NH1	1:B:193:LEU:HD21	2.36	0.41
1:B:293:LEU:HD13	1:B:368:LEU:HD22	2.03	0.41
1:B:244:LYS:HB3	1:B:244:LYS:HE3	1.97	0.40
1:C:152:GLY:H	6:C:402:NFK:CAF	2.34	0.40
1:C:320:LEU:HD23	1:C:320:LEU:HA	1.79	0.40
1:C:336:LEU:O	1:C:339:LYS:HG3	2.21	0.40
1:A:125:LEU:HD23	1:A:125:LEU:HA	1.85	0.40
1:B:119:SER:HB2	1:B:320:LEU:HD12	2.04	0.40

There are no symmetry-related clashes.

## 5.3 Torsion angles [i](#)

### 5.3.1 Protein backbone [i](#)

In the following table, the Percentiles column shows the percent Ramachandran outliers of the chain as a percentile score with respect to all X-ray entries followed by that with respect to entries of similar resolution.

The Analysed column shows the number of residues for which the backbone conformation was analysed, and the total number of residues.

Mol	Chain	Analysed	Favoured	Allowed	Outliers	Percentiles
1	A	348/380 (92%)	333 (96%)	14 (4%)	1 (0%)	41 61
1	B	332/380 (87%)	325 (98%)	6 (2%)	1 (0%)	41 61
1	C	320/380 (84%)	307 (96%)	12 (4%)	1 (0%)	41 61
1	D	326/380 (86%)	317 (97%)	9 (3%)	0	100 100
All	All	1326/1520 (87%)	1282 (97%)	41 (3%)	3 (0%)	47 68

All (3) Ramachandran outliers are listed below:

Mol	Chain	Res	Type
1	A	183	ASN
1	B	171	MET
1	C	379	PRO

### 5.3.2 Protein sidechains [i](#)

In the following table, the Percentiles column shows the percent sidechain outliers of the chain as a percentile score with respect to all X-ray entries followed by that with respect to entries of similar resolution.

The Analysed column shows the number of residues for which the sidechain conformation was analysed, and the total number of residues.

Mol	Chain	Analysed	Rotameric	Outliers	Percentiles	
1	A	322/348 (92%)	307 (95%)	15 (5%)	26	49
1	B	307/348 (88%)	290 (94%)	17 (6%)	21	41
1	C	301/348 (86%)	289 (96%)	12 (4%)	31	56
1	D	308/348 (88%)	289 (94%)	19 (6%)	18	35
All	All	1238/1392 (89%)	1175 (95%)	63 (5%)	24	45

All (63) residues with a non-rotameric sidechain are listed below:

Mol	Chain	Res	Type
1	A	40	LEU
1	A	49	GLU
1	A	101	HIS
1	A	132	LEU
1	A	181	ARG
1	A	185	LYS
1	A	193	LEU
1	A	232	ARG
1	A	241	ILE
1	A	271	LYS
1	A	334	ARG
1	A	338	SER
1	A	372	LEU
1	A	381	MET
1	A	385	ILE
1	B	49	GLU
1	B	101	HIS

*Continued on next page...*



*Continued from previous page...*

<b>Mol</b>	<b>Chain</b>	<b>Res</b>	<b>Type</b>
1	B	132	LEU
1	B	138	LEU
1	B	148	SER
1	B	169	GLN
1	B	171	MET
1	B	182	ASP
1	B	187	GLU
1	B	192	LEU
1	B	237	GLU
1	B	259	LYS
1	B	313	SER
1	B	322	THR
1	B	358	ARG
1	B	363	VAL
1	B	380	LYS
1	C	49	GLU
1	C	132	LEU
1	C	153	PHE
1	C	185	LYS
1	C	196	GLU
1	C	240	ARG
1	C	282	ARG
1	C	313	SER
1	C	352	ARG
1	C	372	LEU
1	C	380	LYS
1	C	386	HIS
1	D	49	GLU
1	D	101	HIS
1	D	132	LEU
1	D	149	PRO
1	D	153	PHE
1	D	168	LEU
1	D	176	ASN
1	D	187	GLU
1	D	190	GLU
1	D	193	LEU
1	D	194	LYS
1	D	251	GLU
1	D	277	LEU
1	D	336	LEU
1	D	349	HIS

*Continued on next page...*

*Continued from previous page...*

Mol	Chain	Res	Type
1	D	352	ARG
1	D	353	SER
1	D	363	VAL
1	D	372	LEU

Sometimes sidechains can be flipped to improve hydrogen bonding and reduce clashes. All (3) such sidechains are listed below:

Mol	Chain	Res	Type
1	C	197	GLN
1	D	183	ASN
1	D	327	ASN

### 5.3.3 RNA [i](#)

There are no RNA molecules in this entry.

## 5.4 Non-standard residues in protein, DNA, RNA chains [i](#)

There are no non-standard protein/DNA/RNA residues in this entry.

## 5.5 Carbohydrates [i](#)

There are no monosaccharides in this entry.

## 5.6 Ligand geometry [i](#)

16 ligands are modelled in this entry.

In the following table, the Counts columns list the number of bonds (or angles) for which Mogul statistics could be retrieved, the number of bonds (or angles) that are observed in the model and the number of bonds (or angles) that are defined in the Chemical Component Dictionary. The Link column lists molecule types, if any, to which the group is linked. The Z score for a bond length (or angle) is the number of standard deviations the observed value is removed from the expected value. A bond length (or angle) with  $|Z| > 2$  is considered an outlier worth inspection. RMSZ is the root-mean-square of all Z scores of the bond lengths (or angles).

Mol	Type	Chain	Res	Link	Bond lengths			Bond angles		
					Counts	RMSZ	$\# Z  > 2$	Counts	RMSZ	$\# Z  > 2$
5	PO4	A	405	-	4,4,4	0.82	0	6,6,6	0.49	0

Mol	Type	Chain	Res	Link	Bond lengths			Bond angles		
					Counts	RMSZ	# Z  > 2	Counts	RMSZ	# Z  > 2
6	NFK	C	402	3	15,17,17	1.94	1 (6%)	19,22,22	2.07	3 (15%)
6	NFK	D	402	3	15,17,17	1.31	2 (13%)	19,22,22	2.76	7 (36%)
5	PO4	B	405	-	4,4,4	0.82	0	6,6,6	0.50	0
4	TRP	A	403	-	14,16,16	0.97	1 (7%)	16,22,22	1.10	2 (12%)
3	HEM	C	401	1,6	41,50,50	1.87	6 (14%)	45,82,82	1.98	9 (20%)
3	HEM	D	401	1,6	41,50,50	1.84	6 (14%)	45,82,82	1.82	12 (26%)
4	TRP	B	404	-	14,16,16	0.90	0	16,22,22	1.26	2 (12%)
2	OXY	B	401	3	1,1,1	0.15	0	-		
3	HEM	B	402	2,1	41,50,50	1.97	6 (14%)	45,82,82	1.98	13 (28%)
4	TRP	C	403	-	14,16,16	0.88	1 (7%)	16,22,22	1.06	0
4	TRP	D	403	-	14,16,16	0.89	0	16,22,22	1.19	2 (12%)
2	OXY	A	401	3	1,1,1	0.09	0	-		
4	TRP	A	404	-	14,16,16	0.83	1 (7%)	16,22,22	1.05	2 (12%)
3	HEM	A	402	2,1	41,50,50	1.91	6 (14%)	45,82,82	1.75	9 (20%)
4	TRP	B	403	-	14,16,16	0.98	1 (7%)	16,22,22	1.33	2 (12%)

In the following table, the Chirals column lists the number of chiral outliers, the number of chiral centers analysed, the number of these observed in the model and the number defined in the Chemical Component Dictionary. Similar counts are reported in the Torsion and Rings columns. '-' means no outliers of that kind were identified.

Mol	Type	Chain	Res	Link	Chirals	Torsions	Rings
6	NFK	C	402	3	-	7/15/15/15	0/1/1/1
6	NFK	D	402	3	-	4/15/15/15	0/1/1/1
4	TRP	A	403	-	-	1/7/8/8	0/2/2/2
3	HEM	C	401	1,6	-	2/12/54/54	-
3	HEM	D	401	1,6	-	2/12/54/54	-
4	TRP	B	404	-	-	0/7/8/8	0/2/2/2
3	HEM	B	402	2,1	-	2/12/54/54	-
4	TRP	C	403	-	-	0/7/8/8	0/2/2/2
4	TRP	D	403	-	-	1/7/8/8	0/2/2/2
4	TRP	A	404	-	-	1/7/8/8	0/2/2/2
3	HEM	A	402	2,1	-	2/12/54/54	-
4	TRP	B	403	-	-	1/7/8/8	0/2/2/2

All (31) bond length outliers are listed below:

Mol	Chain	Res	Type	Atoms	Z	Observed(Å)	Ideal(Å)
3	B	402	HEM	C3D-C2D	7.76	1.53	1.36
3	D	401	HEM	C3D-C2D	7.35	1.52	1.36
3	C	401	HEM	C3D-C2D	7.26	1.52	1.36
3	A	402	HEM	C3D-C2D	7.24	1.52	1.36
6	C	402	NFK	CAF-NAL	6.69	1.43	1.34
3	A	402	HEM	C3C-C2C	-5.33	1.33	1.40
3	B	402	HEM	C3C-C2C	-4.84	1.33	1.40
3	C	401	HEM	C3C-C2C	-4.42	1.34	1.40
3	D	401	HEM	C3C-C2C	-3.90	1.35	1.40
3	D	401	HEM	C3C-CAC	3.72	1.55	1.47
6	D	402	NFK	CAF-NAL	3.58	1.39	1.34
3	C	401	HEM	C3C-CAC	3.42	1.54	1.47
3	A	402	HEM	C3C-CAC	3.36	1.54	1.47
3	B	402	HEM	CAA-C2A	3.26	1.56	1.52
3	B	402	HEM	C3C-CAC	3.25	1.54	1.47
3	B	402	HEM	CAB-C3B	3.16	1.56	1.47
3	B	402	HEM	FE-ND	3.06	2.12	1.96
3	A	402	HEM	CAB-C3B	3.03	1.55	1.47
3	C	401	HEM	CAB-C3B	2.83	1.55	1.47
3	A	402	HEM	FE-ND	2.77	2.10	1.96
3	D	401	HEM	CAB-C3B	2.70	1.54	1.47
3	C	401	HEM	FE-ND	2.47	2.09	1.96
4	B	403	TRP	OXT-C	-2.37	1.22	1.30
3	A	402	HEM	CMB-C2B	2.33	1.55	1.50
3	D	401	HEM	CMB-C2B	2.33	1.55	1.50
6	D	402	NFK	CD2-CG	2.32	1.53	1.48
4	A	403	TRP	OXT-C	-2.24	1.23	1.30
3	D	401	HEM	FE-ND	2.14	2.07	1.96
3	C	401	HEM	CMB-C2B	2.12	1.55	1.50
4	C	403	TRP	OXT-C	-2.08	1.23	1.30
4	A	404	TRP	OXT-C	-2.06	1.23	1.30

All (63) bond angle outliers are listed below:

Mol	Chain	Res	Type	Atoms	Z	Observed(°)	Ideal(°)
6	D	402	NFK	CAO-NAL-CAF	-6.91	113.55	126.63
3	B	402	HEM	C4D-ND-C1D	6.27	111.55	105.07
3	C	401	HEM	C4D-ND-C1D	6.02	111.29	105.07
6	C	402	NFK	CAO-NAL-CAF	-5.92	115.42	126.63
3	A	402	HEM	C4D-ND-C1D	5.56	110.81	105.07
3	C	401	HEM	CBA-CAA-C2A	-5.46	103.30	112.62
6	D	402	NFK	CB-CG-CD2	5.36	127.31	119.86
3	C	401	HEM	CBD-CAD-C3D	-5.24	98.06	112.63

*Continued on next page...*

*Continued from previous page...*

Mol	Chain	Res	Type	Atoms	Z	Observed(°)	Ideal(°)
6	D	402	NFK	CA-CB-CG	-5.04	107.28	113.70
6	C	402	NFK	CA-CB-CG	-4.40	108.09	113.70
3	D	401	HEM	C4D-ND-C1D	4.14	109.35	105.07
3	C	401	HEM	C4C-CHD-C1D	4.06	127.92	122.56
3	A	402	HEM	C4C-CHD-C1D	3.96	127.79	122.56
3	B	402	HEM	CBD-CAD-C3D	-3.89	101.81	112.63
3	B	402	HEM	C3B-C2B-C1B	3.64	109.18	106.49
3	A	402	HEM	CBD-CAD-C3D	-3.58	102.68	112.63
3	D	401	HEM	CHD-C1D-ND	3.42	128.15	124.43
3	B	402	HEM	C1B-NB-C4B	3.36	108.55	105.07
3	D	401	HEM	C4C-CHD-C1D	3.28	126.89	122.56
3	D	401	HEM	CBD-CAD-C3D	-3.25	103.61	112.63
6	D	402	NFK	OD1-CG-CB	-3.21	117.04	120.76
3	D	401	HEM	CAD-C3D-C4D	3.14	130.14	124.66
3	D	401	HEM	CHC-C4B-NB	3.14	127.84	124.43
4	B	404	TRP	OXT-C-O	-3.06	117.14	124.09
3	D	401	HEM	CMD-C2D-C1D	3.02	129.64	125.04
6	D	402	NFK	OD1-CG-CD2	-2.93	115.65	120.83
3	B	402	HEM	CMB-C2B-C1B	-2.92	120.59	125.04
3	A	402	HEM	C1B-NB-C4B	2.92	108.08	105.07
4	B	403	TRP	OXT-C-O	-2.90	117.51	124.09
4	B	403	TRP	OXT-C-CA	2.84	123.06	113.38
3	B	402	HEM	CMA-C3A-C4A	-2.70	124.31	128.46
4	D	403	TRP	OXT-C-O	-2.68	118.00	124.09
3	B	402	HEM	C4C-CHD-C1D	2.63	126.03	122.56
3	B	402	HEM	C4A-C3A-C2A	2.63	108.82	107.00
3	C	401	HEM	C1B-NB-C4B	2.62	107.78	105.07
4	D	403	TRP	OXT-C-CA	2.60	122.25	113.38
6	D	402	NFK	OXT-C-CA	2.59	122.21	113.38
6	D	402	NFK	OXT-C-O	-2.55	118.29	124.09
3	A	402	HEM	CBA-CAA-C2A	-2.55	108.27	112.62
3	A	402	HEM	CAA-CBA-CGA	-2.54	106.64	113.76
3	D	401	HEM	C1B-NB-C4B	2.52	107.68	105.07
3	B	402	HEM	CHD-C1D-ND	2.52	127.17	124.43
3	D	401	HEM	CMA-C3A-C4A	-2.48	124.65	128.46
3	B	402	HEM	CHB-C1B-NB	2.42	127.37	124.38
3	D	401	HEM	CHB-C1B-NB	2.41	127.36	124.38
4	B	404	TRP	OXT-C-CA	2.37	121.46	113.38
3	A	402	HEM	CHA-C4D-ND	2.36	127.30	124.38
6	C	402	NFK	CB-CG-CD2	2.31	123.08	119.86
3	C	401	HEM	CMD-C2D-C1D	2.30	128.54	125.04
3	D	401	HEM	CAD-C3D-C2D	-2.27	123.66	127.88

*Continued on next page...*

Continued from previous page...

Mol	Chain	Res	Type	Atoms	Z	Observed(°)	Ideal(°)
3	B	402	HEM	C2B-C1B-NB	-2.27	107.16	109.84
3	C	401	HEM	CHD-C1D-ND	2.25	126.88	124.43
3	B	402	HEM	CAD-C3D-C4D	2.23	128.55	124.66
4	A	403	TRP	OXT-C-O	-2.21	119.07	124.09
3	A	402	HEM	CMD-C2D-C1D	2.20	128.39	125.04
4	A	404	TRP	OXT-C-O	-2.19	119.12	124.09
4	A	404	TRP	OXT-C-CA	2.13	120.66	113.38
3	B	402	HEM	C4B-CHC-C1C	2.13	125.37	122.56
4	A	403	TRP	OXT-C-CA	2.12	120.62	113.38
3	D	401	HEM	C4A-C3A-C2A	2.04	108.42	107.00
3	C	401	HEM	C3C-C4C-NC	-2.04	107.10	110.94
3	A	402	HEM	CMA-C3A-C4A	-2.01	125.37	128.46
3	C	401	HEM	C4B-CHC-C1C	2.00	125.20	122.56

There are no chirality outliers.

All (23) torsion outliers are listed below:

Mol	Chain	Res	Type	Atoms
6	C	402	NFK	C-CA-CB-CG
6	C	402	NFK	CD2-CAO-NAL-CAF
6	C	402	NFK	CAI-CAO-NAL-CAF
6	D	402	NFK	C-CA-CB-CG
6	D	402	NFK	N-CA-CB-CG
6	D	402	NFK	CAI-CAO-NAL-CAF
4	A	403	TRP	CA-CB-CG-CD1
4	B	403	TRP	CA-CB-CG-CD1
6	C	402	NFK	N-CA-CB-CG
6	D	402	NFK	CD2-CAO-NAL-CAF
3	A	402	HEM	CAA-CBA-CGA-O2A
3	C	401	HEM	CAA-CBA-CGA-O1A
3	A	402	HEM	CAA-CBA-CGA-O1A
3	B	402	HEM	CAA-CBA-CGA-O1A
4	A	404	TRP	O-C-CA-N
4	D	403	TRP	O-C-CA-N
3	B	402	HEM	CAA-CBA-CGA-O2A
3	C	401	HEM	CAA-CBA-CGA-O2A
3	D	401	HEM	CAA-CBA-CGA-O2A
3	D	401	HEM	CAA-CBA-CGA-O1A
6	C	402	NFK	OXT-C-CA-N
6	C	402	NFK	CAJ-CD2-CG-OD1
6	C	402	NFK	CAJ-CD2-CG-CB

There are no ring outliers.

10 monomers are involved in 15 short contacts:

Mol	Chain	Res	Type	Clashes	Symm-Clashes
6	C	402	NFK	1	0
6	D	402	NFK	2	0
4	A	403	TRP	3	0
3	C	401	HEM	3	0
3	D	401	HEM	2	0
3	B	402	HEM	1	0
4	D	403	TRP	1	0
2	A	401	OXY	1	0
4	A	404	TRP	1	0
3	A	402	HEM	1	0

The following is a two-dimensional graphical depiction of Mogul quality analysis of bond lengths, bond angles, torsion angles, and ring geometry for all instances of the Ligand of Interest. In addition, ligands with molecular weight > 250 and outliers as shown on the validation Tables will also be included. For torsion angles, if less than 5% of the Mogul distribution of torsion angles is within 10 degrees of the torsion angle in question, then that torsion angle is considered an outlier. Any bond that is central to one or more torsion angles identified as an outlier by Mogul will be highlighted in the graph. For rings, the root-mean-square deviation (RMSD) between the ring in question and similar rings identified by Mogul is calculated over all ring torsion angles. If the average RMSD is greater than 60 degrees and the minimal RMSD between the ring in question and any Mogul-identified rings is also greater than 60 degrees, then that ring is considered an outlier. The outliers are highlighted in purple. The color gray indicates Mogul did not find sufficient equivalents in the CSD to analyse the geometry.

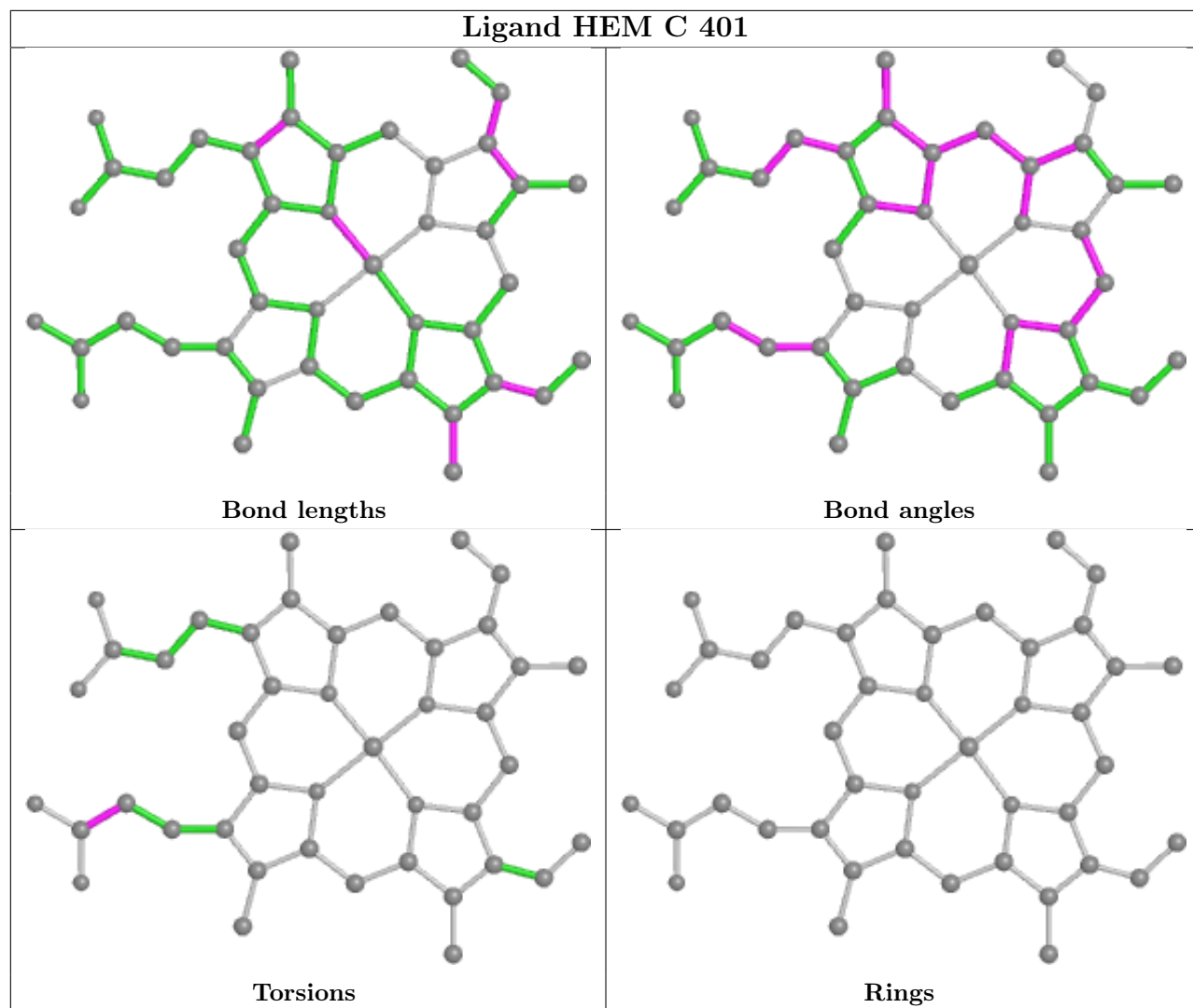



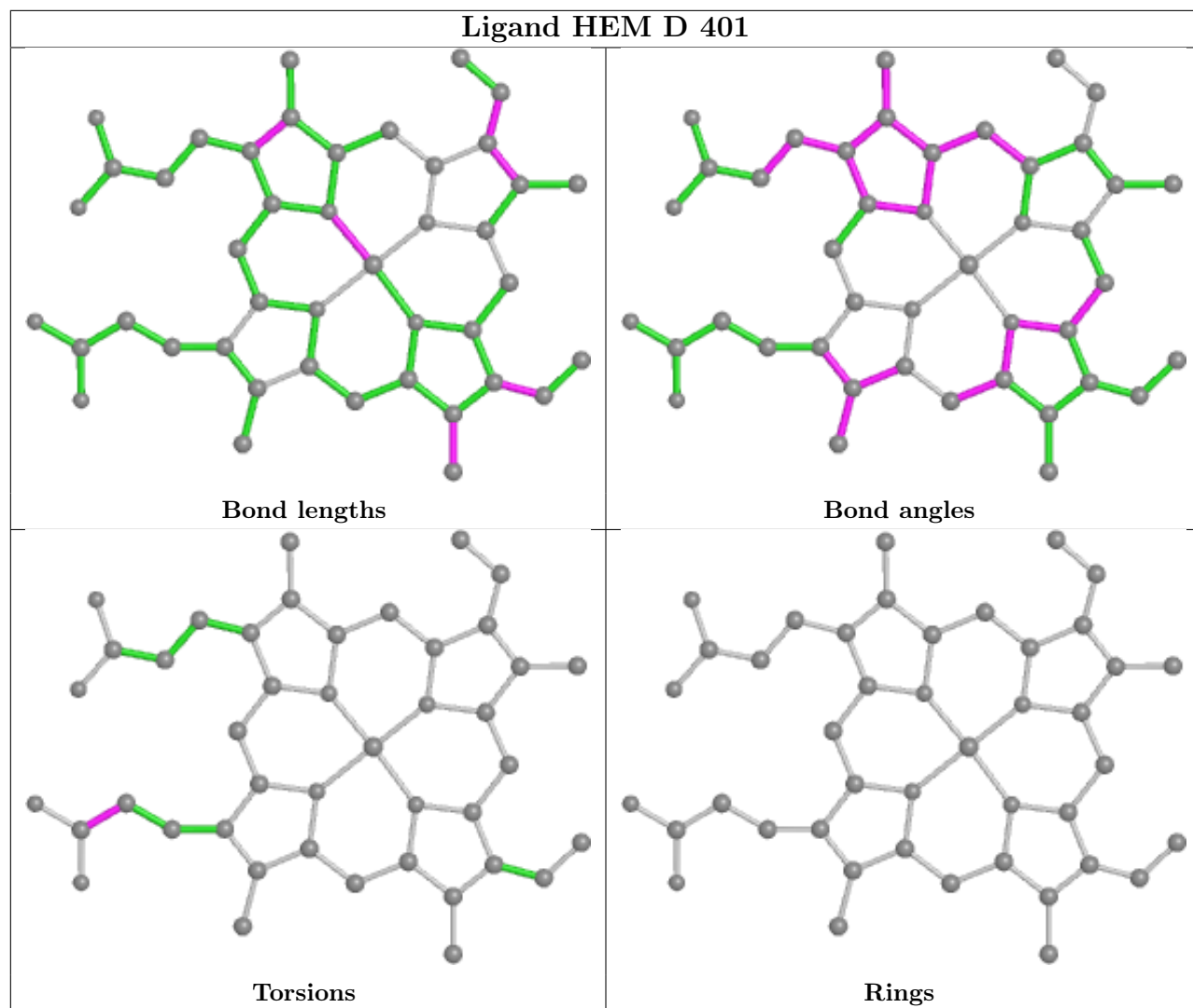

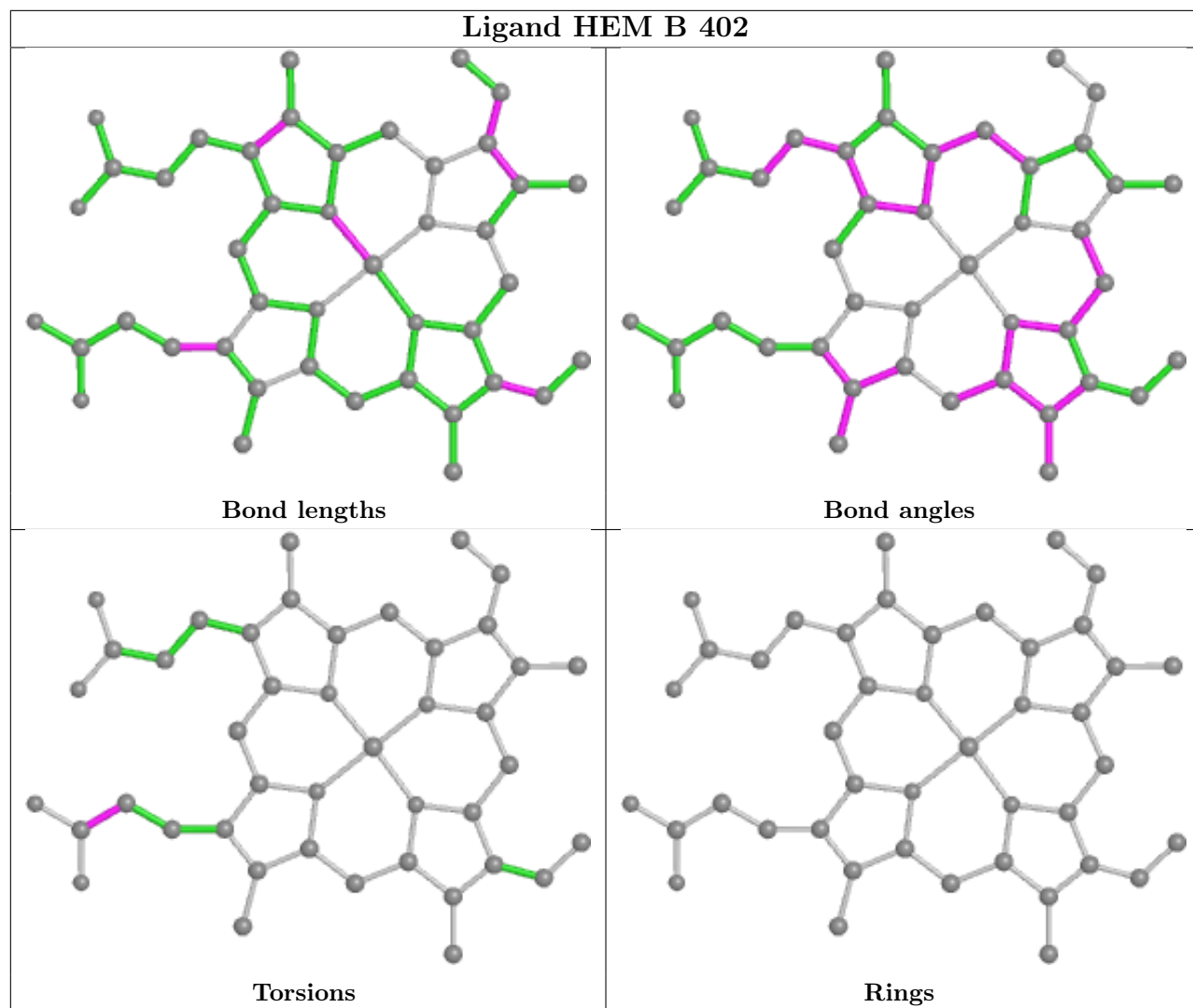

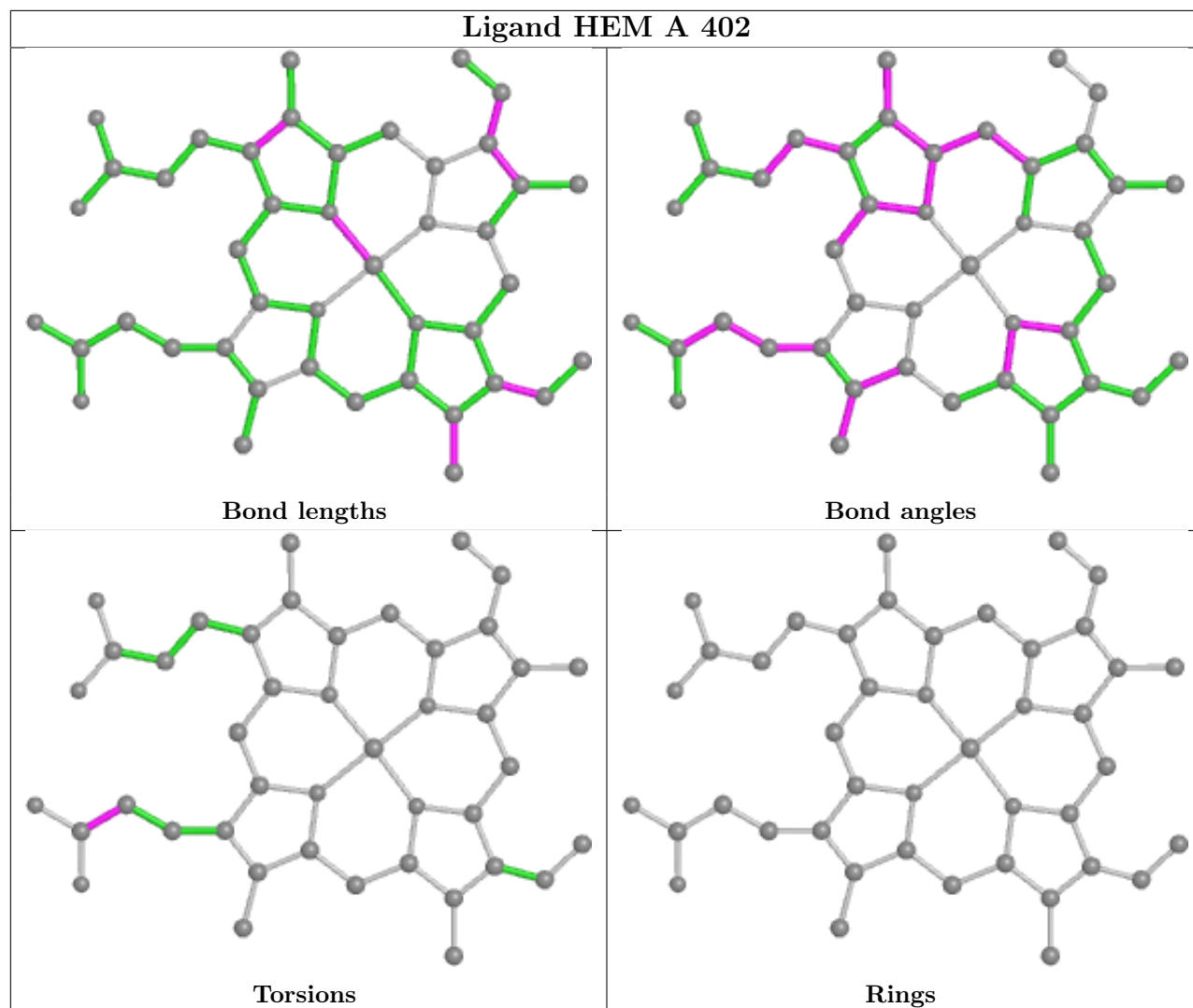

## 5.7 Other polymers [i](#)

There are no such residues in this entry.

## 5.8 Polymer linkage issues [i](#)

There are no chain breaks in this entry.

## 6 Fit of model and data

### 6.1 Protein, DNA and RNA chains

In the following table, the column labelled ‘#RSRZ > 2’ contains the number (and percentage) of RSRZ outliers, followed by percent RSRZ outliers for the chain as percentile scores relative to all X-ray entries and entries of similar resolution. The OWAB column contains the minimum, median, 95<sup>th</sup> percentile and maximum values of the occupancy-weighted average B-factor per residue. The column labelled ‘Q < 0.9’ lists the number of (and percentage) of residues with an average occupancy less than 0.9.

Mol	Chain	Analysed	<RSRZ>	#RSRZ>2	OWAB(Å <sup>2</sup> )	Q<0.9
1	A	350/380 (92%)	0.20	33 (9%) 8 8	30, 48, 102, 146	0
1	B	336/380 (88%)	0.14	21 (6%) 20 21	28, 44, 89, 127	0
1	C	326/380 (85%)	0.62	50 (15%) 2 1	33, 56, 113, 150	0
1	D	332/380 (87%)	0.21	21 (6%) 20 21	30, 50, 94, 155	0
All	All	1344/1520 (88%)	0.29	125 (9%) 8 8	28, 49, 103, 155	0

All (125) RSRZ outliers are listed below:

Mol	Chain	Res	Type	RSRZ
1	C	385	ILE	7.1
1	C	239	ILE	7.0
1	C	238	PHE	6.2
1	C	169	GLN	5.1
1	A	248	GLU	5.0
1	A	385	ILE	4.9
1	A	255	ALA	4.6
1	D	248	GLU	4.5
1	C	276	LEU	4.4
1	C	271	LYS	4.2
1	C	232	ARG	4.1
1	B	38	GLY	4.1
1	D	346	SER	4.0
1	D	193	LEU	3.9
1	A	384	THR	3.9
1	B	241	ILE	3.8
1	C	240	ARG	3.8
1	C	237	GLU	3.8
1	C	184	PHE	3.8
1	A	250	LYS	3.7
1	C	234	LEU	3.6

*Continued on next page...*

*Continued from previous page...*

<b>Mol</b>	<b>Chain</b>	<b>Res</b>	<b>Type</b>	<b>RSRZ</b>
1	C	279	LYS	3.6
1	C	275	HIS	3.6
1	C	257	PHE	3.5
1	A	251	GLU	3.5
1	C	181	ARG	3.4
1	C	230	ILE	3.4
1	B	244	LYS	3.3
1	C	384	THR	3.3
1	A	241	ILE	3.3
1	C	273	HIS	3.3
1	B	240	ARG	3.3
1	B	183	ASN	3.2
1	D	255	ALA	3.2
1	C	277	LEU	3.2
1	C	258	GLN	3.1
1	C	127	GLN	3.1
1	C	182	ASP	3.0
1	C	344	GLY	3.0
1	B	238	PHE	3.0
1	D	252	GLU	3.0
1	D	253	GLN	3.0
1	D	254	VAL	3.0
1	C	231	THR	2.9
1	A	122	LEU	2.9
1	C	185	LYS	2.9
1	A	181	ARG	2.9
1	B	181	ARG	2.9
1	D	124	LEU	2.8
1	A	247	SER	2.8
1	A	246	GLU	2.8
1	C	386	HIS	2.8
1	A	238	PHE	2.8
1	D	241	ILE	2.8
1	D	121	ILE	2.7
1	B	232	ARG	2.7
1	C	121	ILE	2.7
1	C	389	LEU	2.7
1	D	123	LYS	2.7
1	D	125	LEU	2.6
1	B	242	GLN	2.6
1	A	193	LEU	2.6
1	C	226	LEU	2.6

*Continued on next page...*

*Continued from previous page...*

<b>Mol</b>	<b>Chain</b>	<b>Res</b>	<b>Type</b>	<b>RSRZ</b>
1	A	344	GLY	2.6
1	C	190	GLU	2.6
1	D	257	PHE	2.6
1	D	126	VAL	2.6
1	D	251	GLU	2.6
1	D	258	GLN	2.5
1	C	153	PHE	2.5
1	D	382	ASN	2.5
1	A	340	ALA	2.5
1	C	120	VAL	2.5
1	C	124	LEU	2.5
1	A	184	PHE	2.5
1	A	252	GLU	2.5
1	B	120	VAL	2.4
1	C	272	ARG	2.4
1	B	236	GLU	2.4
1	B	123	LYS	2.4
1	C	380	LYS	2.4
1	C	123	LYS	2.4
1	D	127	GLN	2.4
1	A	176	ASN	2.4
1	B	124	LEU	2.4
1	C	125	LEU	2.4
1	D	122	LEU	2.4
1	B	127	GLN	2.4
1	B	344	GLY	2.4
1	A	345	SER	2.3
1	C	119	SER	2.3
1	C	183	ASN	2.3
1	C	225	LYS	2.3
1	A	253	GLN	2.3
1	A	254	VAL	2.3
1	A	383	PRO	2.3
1	B	245	GLU	2.3
1	A	242	GLN	2.2
1	B	171	MET	2.2
1	A	245	GLU	2.2
1	A	125	LEU	2.2
1	C	233	GLY	2.2
1	D	182	ASP	2.2
1	B	249	GLU	2.2
1	C	130	SER	2.2

*Continued on next page...*

*Continued from previous page...*

Mol	Chain	Res	Type	RSRZ
1	C	387	LYS	2.2
1	A	119	SER	2.2
1	C	377	TRP	2.1
1	A	127	GLN	2.1
1	B	248	GLU	2.1
1	B	119	SER	2.1
1	A	249	GLU	2.1
1	A	388	PHE	2.1
1	C	278	SER	2.1
1	C	382	ASN	2.1
1	B	376	HIS	2.1
1	C	122	LEU	2.1
1	C	388	PHE	2.1
1	C	170	ASN	2.0
1	D	130	SER	2.0
1	A	244	LYS	2.0
1	A	177	ARG	2.0
1	A	382	ASN	2.0
1	C	189	ASN	2.0
1	A	123	LYS	2.0

## 6.2 Non-standard residues in protein, DNA, RNA chains [i](#)

There are no non-standard protein/DNA/RNA residues in this entry.

## 6.3 Carbohydrates [i](#)

There are no monosaccharides in this entry.

## 6.4 Ligands [i](#)

In the following table, the Atoms column lists the number of modelled atoms in the group and the number defined in the chemical component dictionary. The B-factors column lists the minimum, median, 95<sup>th</sup> percentile and maximum values of B factors of atoms in the group. The column labelled 'Q< 0.9' lists the number of atoms with occupancy less than 0.9.

Mol	Type	Chain	Res	Atoms	RSCC	RSR	B-factors(Å <sup>2</sup> )	Q<0.9
5	PO4	A	405	5/5	0.93	0.39	105,108,112,118	0
5	PO4	B	405	5/5	0.93	0.48	106,117,121,122	0
4	TRP	B	403	15/15	0.94	0.15	43,54,61,63	0

*Continued on next page...*

*Continued from previous page...*

Mol	Type	Chain	Res	Atoms	RSCC	RSR	B-factors( $\text{\AA}^2$ )	Q<0.9
3	HEM	A	402	43/43	0.96	0.14	30,44,57,59	0
3	HEM	C	401	43/43	0.96	0.13	42,49,61,65	0
4	TRP	A	403	15/15	0.96	0.26	63,69,74,75	0
4	TRP	C	403	15/15	0.97	0.14	45,51,63,72	0
4	TRP	D	403	15/15	0.97	0.19	39,49,57,60	0
4	TRP	A	404	15/15	0.97	0.12	33,41,53,60	0
4	TRP	B	404	15/15	0.97	0.13	38,41,52,53	0
6	NFK	C	402	17/17	0.97	0.22	60,79,94,101	0
6	NFK	D	402	17/17	0.97	0.17	47,70,98,99	0
3	HEM	B	402	43/43	0.98	0.12	31,43,52,61	0
2	OXY	B	401	2/2	0.99	0.11	54,54,54,56	0
3	HEM	D	401	43/43	0.99	0.13	26,46,61,66	0
2	OXY	A	401	2/2	1.00	0.10	73,73,73,76	0

The following is a graphical depiction of the model fit to experimental electron density of all instances of the Ligand of Interest. In addition, ligands with molecular weight > 250 and outliers as shown on the geometry validation Tables will also be included. Each fit is shown from different orientation to approximate a three-dimensional view.



**Electron density around HEM A 402:**

$2mF_o-DF_c$  (at 0.7 rmsd) in gray  
 $mF_o-DF_c$  (at 3 rmsd) in purple (negative)  
and green (positive)

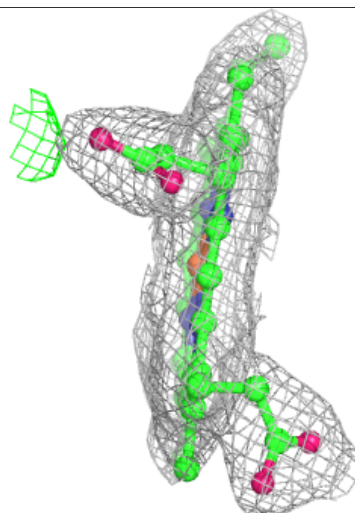
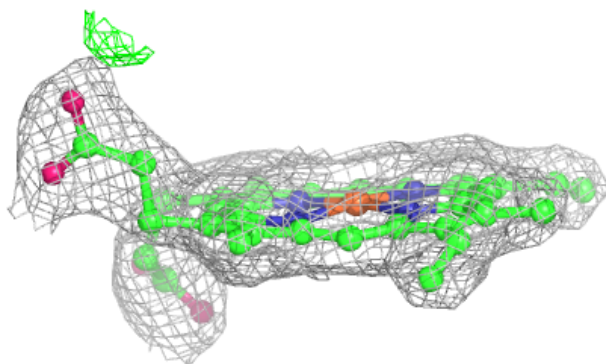
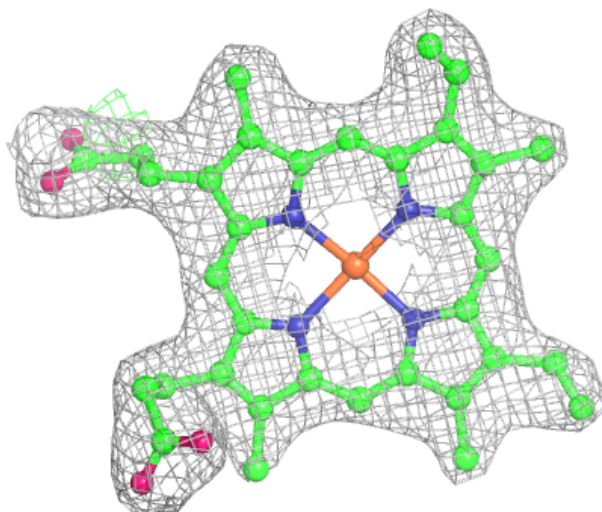

**Electron density around HEM C 401:**

$2mF_o-DF_c$  (at 0.7 rmsd) in gray  
 $mF_o-DF_c$  (at 3 rmsd) in purple (negative)  
and green (positive)

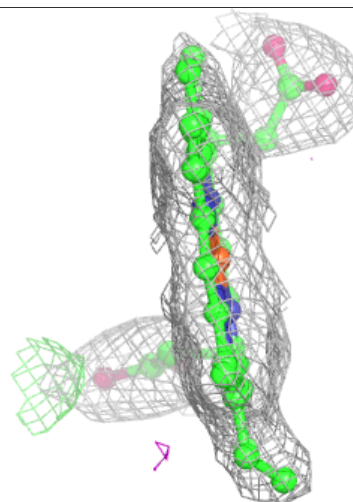
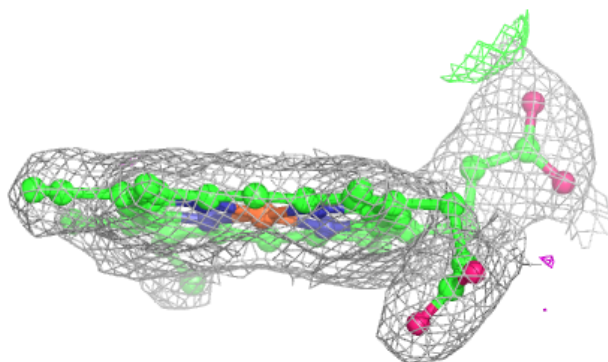
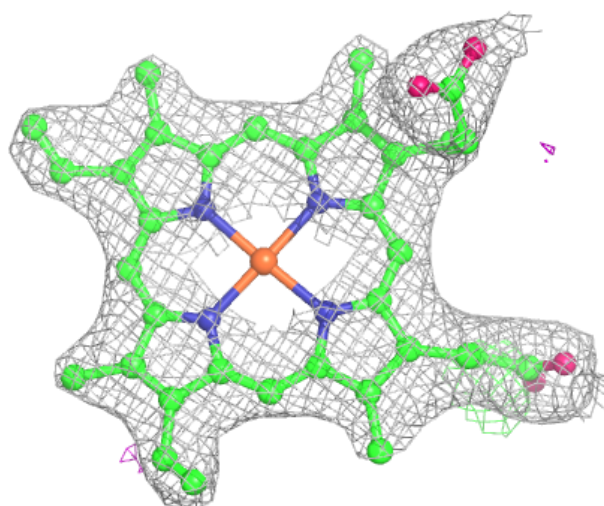

**Electron density around HEM B 402:**

$2mF_o-DF_c$  (at 0.7 rmsd) in gray  
 $mF_o-DF_c$  (at 3 rmsd) in purple (negative)  
and green (positive)

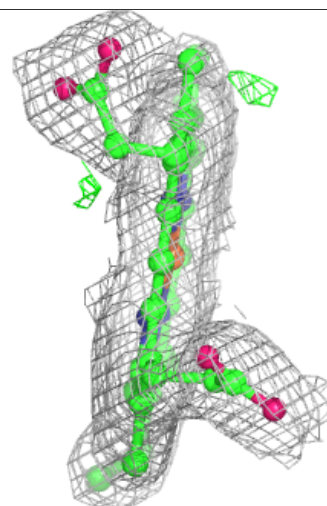
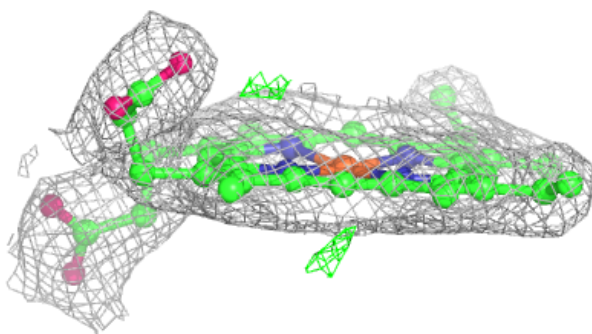
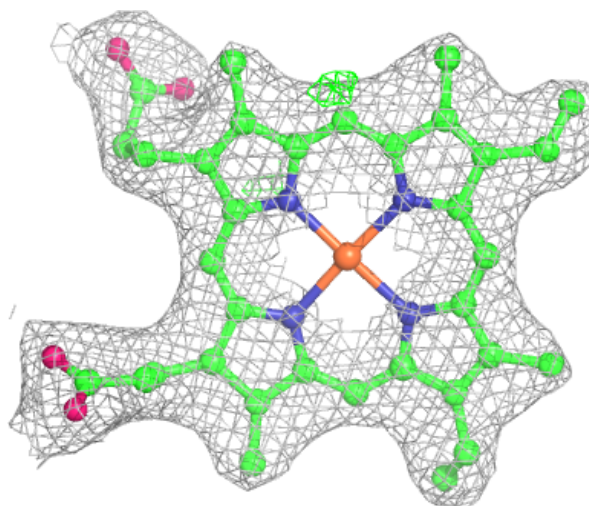

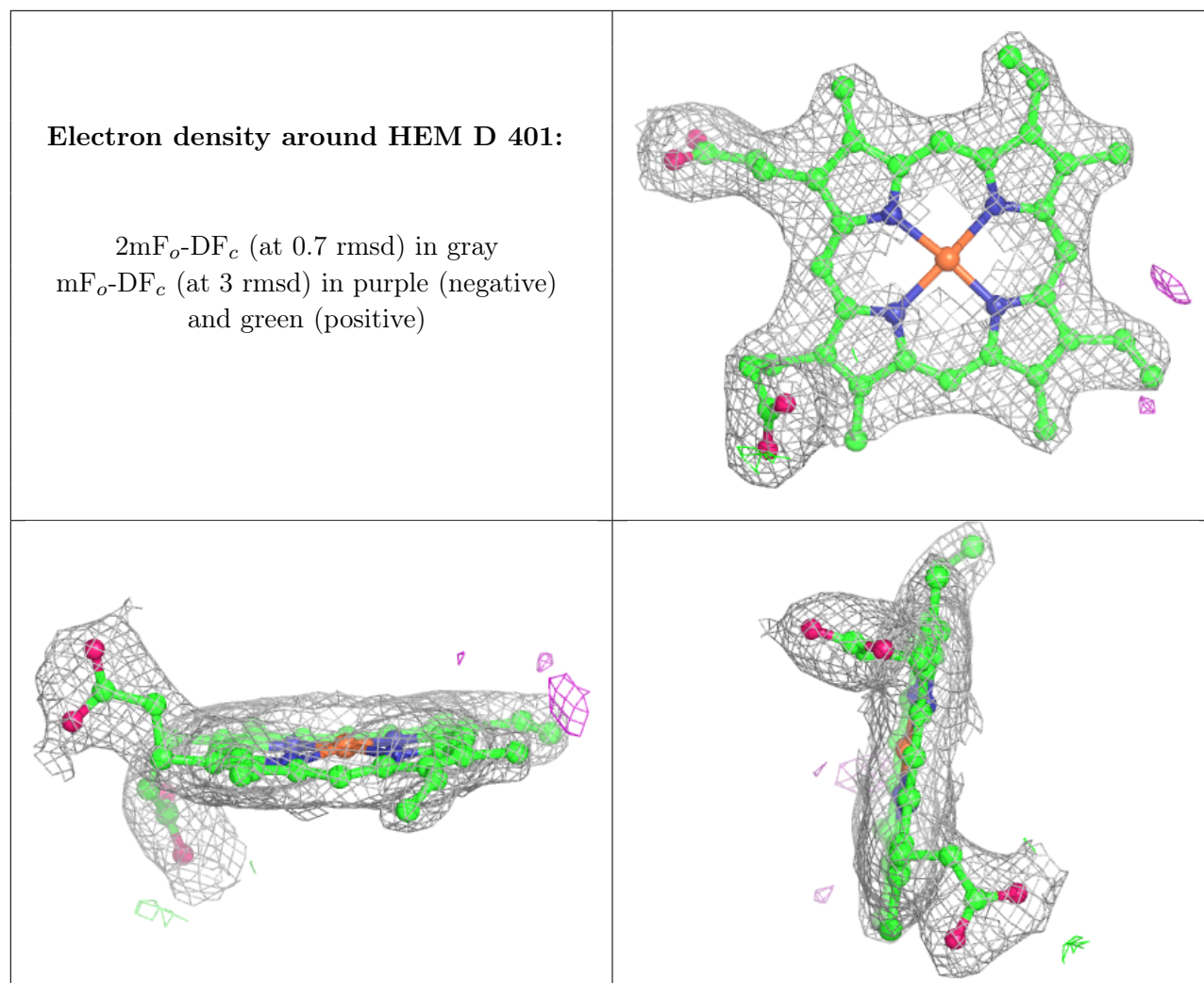

## 6.5 Other polymers [i](#)

There are no such residues in this entry.