



# Full wwPDB X-ray Structure Validation Report ⓘ

Nov 6, 2023 – 06:35 AM EST

PDB ID : 5KS8  
Title : Crystal structure of two-subunit pyruvate carboxylase from *Methylobacillus flagellatus*  
Authors : Choi, P.H.; Tong, L.  
Deposited on : 2016-07-07  
Resolution : 3.01 Å (reported)

This is a Full wwPDB X-ray Structure Validation Report for a publicly released PDB entry.

We welcome your comments at [validation@mail.wwpdb.org](mailto:validation@mail.wwpdb.org)

A user guide is available at

<https://www.wwpdb.org/validation/2017/XrayValidationReportHelp>

with specific help available everywhere you see the ⓘ symbol.

The types of validation reports are described at

<http://www.wwpdb.org/validation/2017/FAQs#types>.

---

The following versions of software and data (see [references ⓘ](#)) were used in the production of this report:

MolProbity : 4.02b-467  
Mogul : 1.8.5 (274361), CSD as541be (2020)  
Xtriage (Phenix) : 1.13  
EDS : 2.36  
Percentile statistics : 20191225.v01 (using entries in the PDB archive December 25th 2019)  
Refmac : 5.8.0158  
CCP4 : 7.0.044 (Gargrove)  
Ideal geometry (proteins) : Engh & Huber (2001)  
Ideal geometry (DNA, RNA) : Parkinson et al. (1996)  
Validation Pipeline (wwPDB-VP) : 2.36

# 1 Overall quality at a glance i

The following experimental techniques were used to determine the structure:

*X-RAY DIFFRACTION*

The reported resolution of this entry is 3.01 Å.

Percentile scores (ranging between 0-100) for global validation metrics of the entry are shown in the following graphic. The table shows the number of entries on which the scores are based.

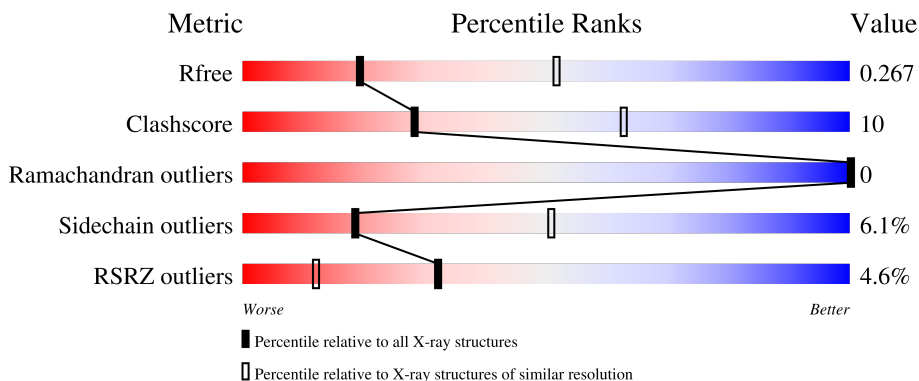

Metric	Whole archive (#Entries)	Similar resolution (#Entries, resolution range(Å))
$R_{free}$	130704	2399 (3.04-3.00)
Clashscore	141614	2734 (3.04-3.00)
Ramachandran outliers	138981	2640 (3.04-3.00)
Sidechain outliers	138945	2643 (3.04-3.00)
RSRZ outliers	127900	2287 (3.04-3.00)

The table below summarises the geometric issues observed across the polymeric chains and their fit to the electron density. The red, orange, yellow and green segments of the lower bar indicate the fraction of residues that contain outliers for  $\geq 3$ , 2, 1 and 0 types of geometric quality criteria respectively. A grey segment represents the fraction of residues that are not modelled. The numeric value for each fraction is indicated below the corresponding segment, with a dot representing fractions  $\leq 5\%$ . The upper red bar (where present) indicates the fraction of residues that have poor fit to the electron density. The numeric value is given above the bar.

Mol	Chain	Length	Quality of chain
1	A	405	79% 19% .
1	B	405	79% 20% .
2	C	617	72% 24% ..
2	D	617	72% 20% . 6%
2	E	617	10% 57% 11% . 30%

*Continued on next page...*

*Continued from previous page...*

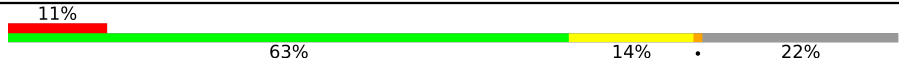
Mol	Chain	Length	Quality of chain
2	F	617	 <p>A horizontal bar chart representing the quality of chain. The bar is divided into four segments: a red segment on the left labeled '11%', a large green segment labeled '63%', a yellow segment labeled '14%', and a grey segment on the right labeled '22%'. A small black dot is located on the boundary between the yellow and grey segments.</p>

## 2 Entry composition [i](#)

There are 5 unique types of molecules in this entry. The entry contains 21684 atoms, of which 0 are hydrogens and 0 are deuteriums.

In the tables below, the ZeroOcc column contains the number of atoms modelled with zero occupancy, the AltConf column contains the number of residues with at least one atom in alternate conformation and the Trace column contains the number of residues modelled with at most 2 atoms.

- Molecule 1 is a protein called Pyruvate carboxylase subunit alpha.

Mol	Chain	Residues	Atoms					ZeroOcc	AltConf	Trace
			Total	C	N	O	S			
1	A	404	Total 3139	C 1985	N 557	O 582	S 15	0	0	0
1	B	404	Total 3149	C 1992	N 558	O 583	S 16	0	0	0

There are 8 discrepancies between the modelled and reference sequences:

Chain	Residue	Modelled	Actual	Comment	Reference
A	131	GLY	-	linker	UNP Q1H158
A	132	SER	-	linker	UNP Q1H158
A	200	SER	-	linker	UNP Q1H158
A	201	GLY	-	linker	UNP Q1H158
B	131	GLY	-	linker	UNP Q1H158
B	132	SER	-	linker	UNP Q1H158
B	200	SER	-	linker	UNP Q1H158
B	201	GLY	-	linker	UNP Q1H158

- Molecule 2 is a protein called Pyruvate carboxylase subunit beta.

Mol	Chain	Residues	Atoms					ZeroOcc	AltConf	Trace
			Total	C	N	O	S			
2	C	603	Total 4554	C 2862	N 787	O 885	S 20	0	0	0
2	D	580	Total 4410	C 2777	N 760	O 853	S 20	0	0	0
2	E	430	Total 2871	C 1768	N 514	O 581	S 8	0	0	0
2	F	482	Total 3531	C 2211	N 606	O 698	S 16	0	0	0

There are 12 discrepancies between the modelled and reference sequences:

Chain	Residue	Modelled	Actual	Comment	Reference
C	419	ALA	LYS	conflict	UNP Q1H157
C	421	ALA	GLU	conflict	UNP Q1H157
C	422	ALA	GLU	conflict	UNP Q1H157
D	419	ALA	LYS	conflict	UNP Q1H157
D	421	ALA	GLU	conflict	UNP Q1H157
D	422	ALA	GLU	conflict	UNP Q1H157
E	419	ALA	LYS	conflict	UNP Q1H157
E	421	ALA	GLU	conflict	UNP Q1H157
E	422	ALA	GLU	conflict	UNP Q1H157
F	419	ALA	LYS	conflict	UNP Q1H157
F	421	ALA	GLU	conflict	UNP Q1H157
F	422	ALA	GLU	conflict	UNP Q1H157

- Molecule 3 is 5-(HEXAHYDRO-2-OXO-1H-THIENO[3,4-D]IMIDAZOL-6-YL)PENTANAL (three-letter code: BTI) (formula: C<sub>10</sub>H<sub>16</sub>N<sub>2</sub>O<sub>2</sub>S).

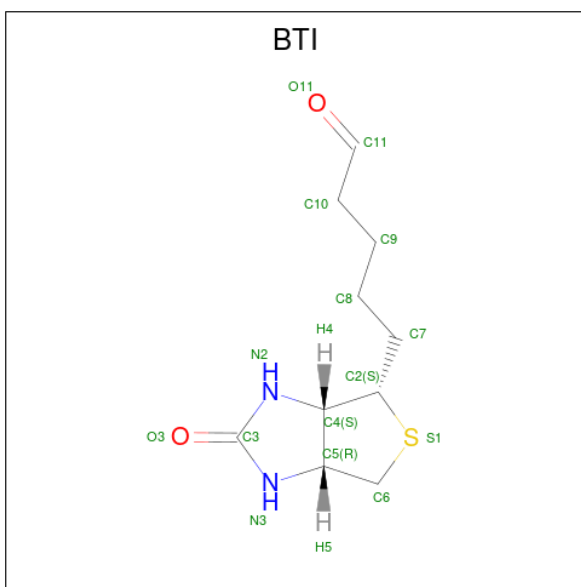

Mol	Chain	Residues	Atoms					ZeroOcc	AltConf
			Total	C	N	O	S		
3	C	1	15	10	2	2	1	0	0

- Molecule 4 is PYRUVIC ACID (three-letter code: PYR) (formula: C<sub>3</sub>H<sub>4</sub>O<sub>3</sub>).

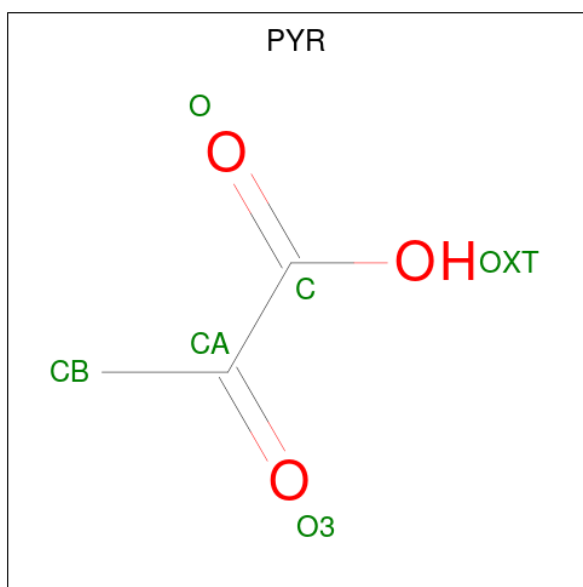

Mol	Chain	Residues	Atoms	ZeroOcc	AltConf
4	C	1	Total C O 6 3 3	0	0
4	D	1	Total C O 6 3 3	0	0

- Molecule 5 is MANGANESE (II) ION (three-letter code: MN) (formula: Mn).

Mol	Chain	Residues	Atoms	ZeroOcc	AltConf
5	C	1	Total Mn 1 1	0	0
5	D	1	Total Mn 1 1	0	0
5	F	1	Total Mn 1 1	0	0

### 3 Residue-property plots [i](#)

These plots are drawn for all protein, RNA, DNA and oligosaccharide chains in the entry. The first graphic for a chain summarises the proportions of the various outlier classes displayed in the second graphic. The second graphic shows the sequence view annotated by issues in geometry and electron density. Residues are color-coded according to the number of geometric quality criteria for which they contain at least one outlier: green = 0, yellow = 1, orange = 2 and red = 3 or more. A red dot above a residue indicates a poor fit to the electron density ( $RSRZ > 2$ ). Stretches of 2 or more consecutive residues without any outlier are shown as a green connector. Residues present in the sample, but not in the model, are shown in grey.

- Molecule 1: Pyruvate carboxylase subunit alpha

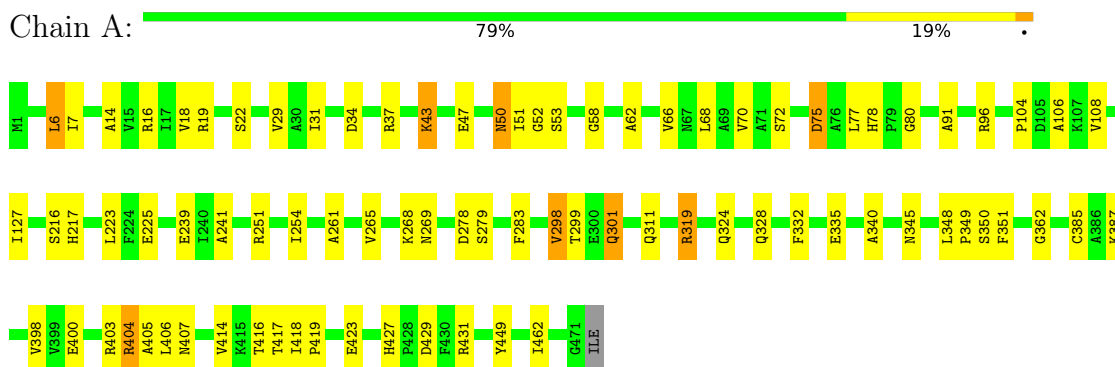

- Molecule 1: Pyruvate carboxylase subunit alpha

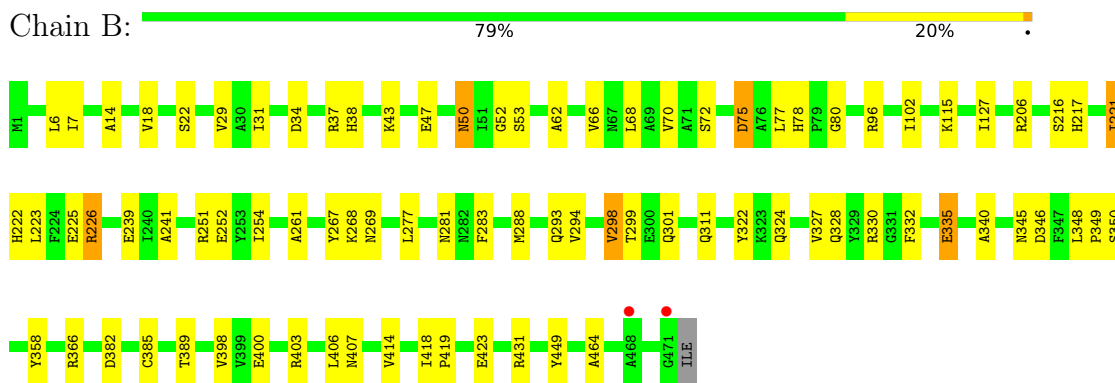

- Molecule 2: Pyruvate carboxylase subunit beta

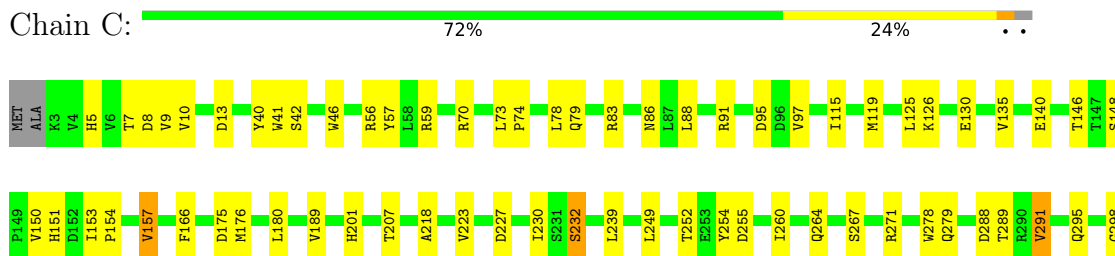

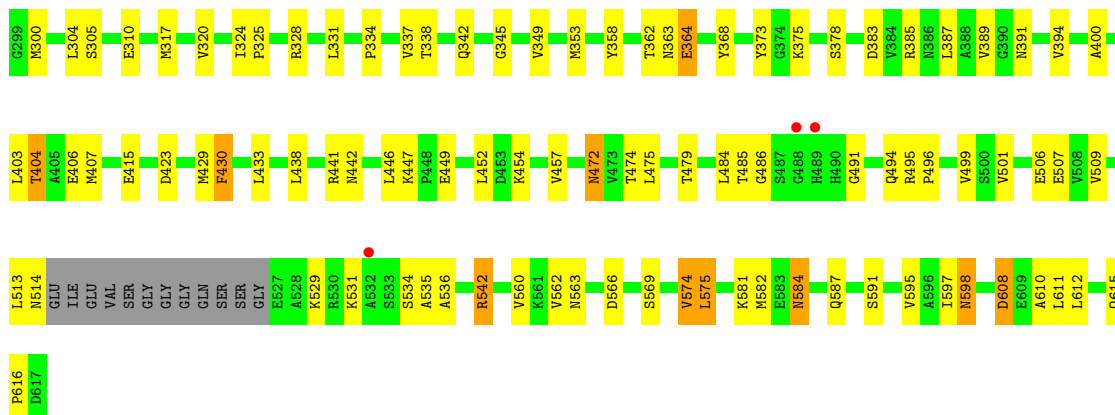

• Molecule 2: Pyruvate carboxylase subunit beta

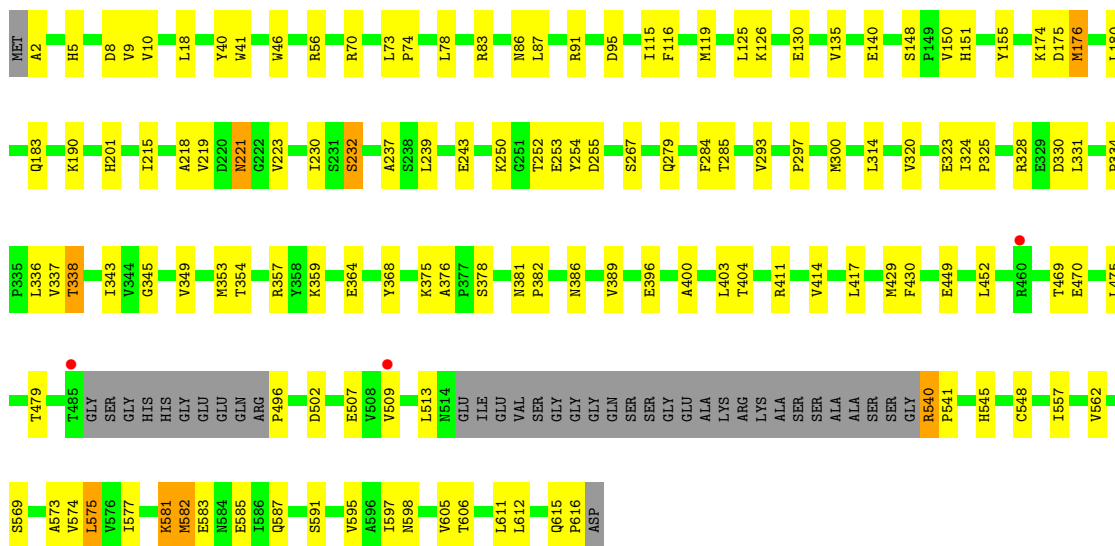

• Molecule 2: Pyruvate carboxylase subunit beta

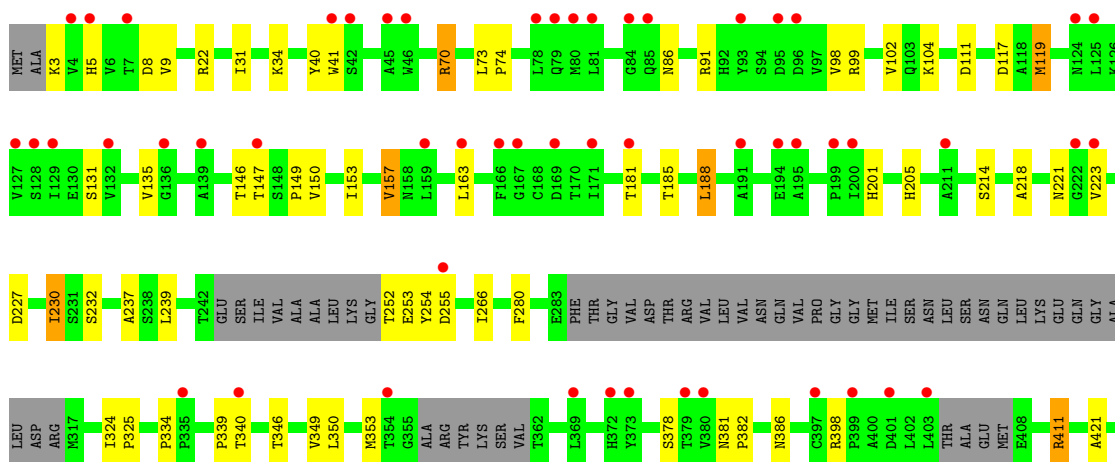





## 4 Data and refinement statistics

Property	Value	Source
Space group	H 3 2	Depositor
Cell constants a, b, c, $\alpha$ , $\beta$ , $\gamma$	285.76Å 285.76Å 274.87Å 90.00° 90.00° 120.00°	Depositor
Resolution (Å)	47.44 – 3.01 47.39 – 3.01	Depositor EDS
% Data completeness (in resolution range)	95.5 (47.44-3.01) 95.6 (47.39-3.01)	Depositor EDS
$R_{merge}$	0.08	Depositor
$R_{sym}$	(Not available)	Depositor
$\langle I/\sigma(I) \rangle$ <sup>1</sup>	1.99 (at 3.01Å)	Xtrriage
Refinement program	REFMAC 5.7.0029	Depositor
R, $R_{free}$	0.225 , 0.272 0.224 , 0.267	Depositor DCC
$R_{free}$ test set	4072 reflections (5.01%)	wwPDB-VP
Wilson B-factor (Å <sup>2</sup> )	87.8	Xtrriage
Anisotropy	0.004	Xtrriage
Bulk solvent $k_{sol}$ (e/Å <sup>3</sup> ), $B_{sol}$ (Å <sup>2</sup> )	0.29 , 80.6	EDS
L-test for twinning <sup>2</sup>	$\langle  L  \rangle = 0.50$ , $\langle L^2 \rangle = 0.33$	Xtrriage
Estimated twinning fraction	No twinning to report.	Xtrriage
$F_o, F_c$ correlation	0.93	EDS
Total number of atoms	21684	wwPDB-VP
Average B, all atoms (Å <sup>2</sup> )	110.0	wwPDB-VP

Xtrriage's analysis on translational NCS is as follows: *The largest off-origin peak in the Patterson function is 2.33% of the height of the origin peak. No significant pseudotranslation is detected.*

<sup>1</sup>Intensities estimated from amplitudes.

<sup>2</sup>Theoretical values of  $\langle |L| \rangle$ ,  $\langle L^2 \rangle$  for acentric reflections are 0.5, 0.333 respectively for untwinned datasets, and 0.375, 0.2 for perfectly twinned datasets.

## 5 Model quality i

### 5.1 Standard geometry i

Bond lengths and bond angles in the following residue types are not validated in this section: BTI, MN, PYR

The Z score for a bond length (or angle) is the number of standard deviations the observed value is removed from the expected value. A bond length (or angle) with  $|Z| > 5$  is considered an outlier worth inspection. RMSZ is the root-mean-square of all Z scores of the bond lengths (or angles).

Mol	Chain	Bond lengths		Bond angles	
		RMSZ	# $ Z  > 5$	RMSZ	# $ Z  > 5$
1	A	0.53	0/3203	0.78	3/4340 (0.1%)
1	B	0.58	0/3214	0.79	0/4353
2	C	0.54	0/4629	0.76	3/6287 (0.0%)
2	D	0.56	0/4484	0.75	3/6093 (0.0%)
2	E	0.43	0/2910	0.72	4/3989 (0.1%)
2	F	0.42	0/3586	0.67	1/4884 (0.0%)
All	All	0.52	0/22026	0.75	14/29946 (0.0%)

There are no bond length outliers.

All (14) bond angle outliers are listed below:

Mol	Chain	Res	Type	Atoms	Z	Observed(°)	Ideal(°)
2	E	398	ARG	NE-CZ-NH1	6.95	123.77	120.30
2	D	612	LEU	CA-CB-CG	6.94	131.26	115.30
2	E	398	ARG	NE-CZ-NH2	-6.68	116.96	120.30
2	C	291	VAL	CB-CA-C	-6.12	99.78	111.40
2	D	502	ASP	CB-CG-OD2	5.84	123.56	118.30
1	A	319	ARG	NE-CZ-NH1	5.71	123.16	120.30
2	C	271	ARG	CG-CD-NE	5.68	123.73	111.80
2	E	484	LEU	CA-CB-CG	5.66	128.32	115.30
2	F	290	ARG	NE-CZ-NH1	5.58	123.09	120.30
1	A	404	ARG	NE-CZ-NH1	5.48	123.04	120.30
2	D	612	LEU	CB-CA-C	-5.46	99.82	110.20
2	C	484	LEU	CA-CB-CG	5.41	127.75	115.30
1	A	404	ARG	NE-CZ-NH2	-5.40	117.60	120.30
2	E	398	ARG	CD-NE-CZ	5.11	130.75	123.60

There are no chirality outliers.

There are no planarity outliers.

## 5.2 Too-close contacts [i](#)

In the following table, the Non-H and H(model) columns list the number of non-hydrogen atoms and hydrogen atoms in the chain respectively. The H(added) column lists the number of hydrogen atoms added and optimized by MolProbity. The Clashes column lists the number of clashes within the asymmetric unit, whereas Symm-Clashes lists symmetry-related clashes.

Mol	Chain	Non-H	H(model)	H(added)	Clashes	Symm-Clashes
1	A	3139	0	3117	58	0
1	B	3149	0	3128	59	0
2	C	4554	0	4540	117	0
2	D	4410	0	4410	101	0
2	E	2871	0	2421	55	1
2	F	3531	0	3343	60	1
3	C	15	0	15	1	0
4	C	6	0	0	0	0
4	D	6	0	0	0	0
5	C	1	0	0	0	0
5	D	1	0	0	0	0
5	F	1	0	0	0	0
All	All	21684	0	20974	418	1

The all-atom clashscore is defined as the number of clashes found per 1000 atoms (including hydrogen atoms). The all-atom clashscore for this structure is 10.

All (418) close contacts within the same asymmetric unit are listed below, sorted by their clash magnitude.

Atom-1	Atom-2	Interatomic distance (Å)	Clash overlap (Å)
2:F:548:CYS:SG	2:F:610:ALA:HB1	1.86	1.15
2:F:548:CYS:SG	2:F:610:ALA:CB	2.49	1.00
2:E:22:ARG:HG3	2:E:280:PHE:CE1	2.08	0.88
2:D:2:ALA:O	2:D:254:TYR:HA	1.72	0.88
2:F:474:THR:HG22	2:F:479:THR:HG23	1.54	0.87
2:E:22:ARG:HG3	2:E:280:PHE:CD1	2.12	0.85
1:B:37:ARG:NH2	2:C:507:GLU:OE1	2.09	0.84
2:D:9:VAL:HG21	2:D:239:LEU:HD12	1.59	0.84
2:D:545:HIS:HB2	2:D:548:CYS:SG	2.16	0.84
2:D:9:VAL:HG21	2:D:239:LEU:CD1	2.11	0.81
2:C:260:ILE:O	2:C:264:GLN:HG3	1.82	0.80
2:E:9:VAL:HG21	2:E:239:LEU:HD12	1.64	0.79
2:D:116:PHE:CE1	2:D:337:VAL:HG11	2.19	0.78
2:C:475:LEU:HD13	2:D:507:GLU:O	1.84	0.77
2:E:119:MET:CE	2:E:340:THR:HG21	2.14	0.77

*Continued on next page...*

*Continued from previous page...*

Atom-1	Atom-2	Interatomic distance (Å)	Clash overlap (Å)
1:A:22:SER:O	1:B:403:ARG:NH2	2.17	0.77
1:A:400:GLU:OE2	1:A:403:ARG:NH1	2.19	0.76
2:C:9:VAL:HG11	2:C:13:ASP:HB3	1.67	0.75
1:A:265:VAL:HG12	1:A:265:VAL:O	1.87	0.74
2:D:582:MET:SD	2:D:583:GLU:N	2.60	0.74
2:F:548:CYS:HG	2:F:610:ALA:HB1	1.53	0.73
2:C:126:LYS:HG3	2:C:166:PHE:CE2	2.25	0.72
2:D:331:LEU:HB3	2:D:368:TYR:CE1	2.25	0.71
1:B:222:HIS:CD2	1:B:324:GLN:HE22	2.11	0.68
1:A:403:ARG:NH2	1:B:22:SER:O	2.27	0.68
2:E:119:MET:HE1	2:E:340:THR:HG21	1.74	0.67
1:A:269:ASN:OD1	1:A:311:GLN:HG2	1.95	0.67
2:C:278:TRP:CZ2	2:C:454:LYS:HA	2.30	0.66
2:C:423:ASP:CG	2:C:441:ARG:HH22	1.98	0.66
2:C:9:VAL:HG21	2:C:239:LEU:HD13	1.78	0.66
2:C:189:VAL:HG11	2:C:223:VAL:HG23	1.78	0.66
2:C:9:VAL:HG12	2:C:9:VAL:O	1.96	0.65
2:C:150:VAL:HG21	2:C:378:SER:HB2	1.78	0.65
2:F:55:VAL:HG12	2:F:433:LEU:HD21	1.78	0.65
1:A:349:PRO:HB3	1:A:351:PHE:CE2	2.31	0.65
2:E:346:THR:O	2:E:349:VAL:HG22	1.96	0.65
2:C:331:LEU:HB3	2:C:368:TYR:CE1	2.32	0.65
2:D:330:ASP:OD2	2:D:357:ARG:NH2	2.29	0.65
1:A:68:LEU:O	1:A:72:SER:OG	2.07	0.65
2:C:148:SER:OG	2:C:151:HIS:ND1	2.30	0.64
2:C:542:ARG:NH1	2:C:608:ASP:OD1	2.31	0.64
1:B:269:ASN:OD1	1:B:311:GLN:HG2	1.96	0.64
2:C:597:ILE:HG22	2:C:612:LEU:HD22	1.80	0.64
1:A:223:LEU:N	1:A:223:LEU:HD23	2.13	0.63
1:B:223:LEU:HD23	1:B:223:LEU:N	2.11	0.63
2:C:9:VAL:CG1	2:C:13:ASP:HB3	2.28	0.63
2:D:174:LYS:HG2	2:D:176:MET:HG3	1.80	0.63
2:E:119:MET:HE3	2:E:340:THR:HG21	1.80	0.63
1:B:68:LEU:O	1:B:72:SER:OG	2.09	0.63
2:C:400:ALA:HA	2:C:403:LEU:HD12	1.80	0.62
2:D:116:PHE:CE1	2:D:337:VAL:CG1	2.82	0.62
2:F:543:PRO:HB3	2:F:548:CYS:SG	2.38	0.62
2:C:300:MET:CE	2:C:324:ILE:HD13	2.30	0.62
2:D:126:LYS:O	2:D:130:GLU:HG3	2.00	0.62
2:F:548:CYS:SG	2:F:610:ALA:HB2	2.40	0.62
1:A:241:ALA:HB3	1:A:298:VAL:HG13	1.82	0.61

*Continued on next page...*

*Continued from previous page...*

Atom-1	Atom-2	Interatomic distance (Å)	Clash overlap (Å)
2:C:126:LYS:O	2:C:130:GLU:HG3	2.00	0.61
2:E:205:HIS:HA	2:E:239:LEU:HD23	1.80	0.61
2:F:400:ALA:HA	2:F:403:LEU:HD12	1.82	0.61
2:D:148:SER:OG	2:D:151:HIS:ND1	2.30	0.61
2:C:9:VAL:CG1	2:C:13:ASP:CB	2.78	0.61
2:D:540:ARG:HG3	2:D:541:PRO:HD2	1.82	0.61
2:C:582:MET:SD	2:D:364:GLU:HG3	2.40	0.61
2:C:305:SER:HB3	2:C:317:MET:CE	2.30	0.60
2:E:496:PRO:HB3	2:E:509:VAL:HG22	1.83	0.60
1:B:78:HIS:HD2	1:B:80:GLY:H	1.48	0.60
2:C:304:LEU:HD11	2:C:320:VAL:HG11	1.81	0.60
2:D:70:ARG:CZ	2:D:78:LEU:CD1	2.79	0.60
2:C:496:PRO:HB3	2:C:509:VAL:HG22	1.84	0.60
1:A:400:GLU:OE1	1:A:431:ARG:NH2	2.35	0.60
2:D:496:PRO:HB3	2:D:509:VAL:HG22	1.83	0.60
2:C:362:THR:HG22	2:C:364:GLU:H	1.65	0.60
2:D:215:ILE:O	2:D:219:VAL:HG23	2.01	0.60
2:D:176:MET:SD	2:D:337:VAL:HG22	2.42	0.59
1:B:241:ALA:HB3	1:B:298:VAL:HG13	1.84	0.59
2:C:9:VAL:HG11	2:C:13:ASP:CB	2.32	0.59
2:F:148:SER:OG	2:F:151:HIS:ND1	2.33	0.59
2:C:300:MET:HE1	2:C:324:ILE:HD13	1.83	0.59
2:E:150:VAL:HG21	2:E:378:SER:HB2	1.84	0.59
1:B:239:GLU:OE1	1:B:335:GLU:OE1	2.21	0.59
2:C:581:LYS:HE2	2:D:56:ARG:CD	2.33	0.59
2:E:153:ILE:CB	2:E:188:LEU:HD22	2.33	0.58
2:D:400:ALA:HA	2:D:403:LEU:HD12	1.84	0.58
2:E:102:VAL:HG21	2:E:131:SER:HB3	1.84	0.58
2:F:38:VAL:HG21	2:F:40:TYR:CD2	2.39	0.58
2:C:475:LEU:CD1	2:D:507:GLU:O	2.51	0.58
2:D:87:LEU:HD13	2:D:429:MET:HE1	1.85	0.58
1:A:265:VAL:O	1:A:265:VAL:CG1	2.51	0.58
1:B:221:ILE:CD1	1:B:322:TYR:O	2.51	0.58
1:B:34:ASP:OD1	1:B:37:ARG:NH1	2.36	0.57
2:C:320:VAL:O	2:C:324:ILE:HG13	2.04	0.57
2:C:581:LYS:HE2	2:D:56:ARG:NE	2.19	0.57
2:D:150:VAL:HG21	2:D:378:SER:HB2	1.87	0.57
1:B:66:VAL:O	1:B:70:VAL:HG23	2.04	0.57
2:E:22:ARG:CG	2:E:280:PHE:CD1	2.87	0.57
1:A:6:LEU:HD22	1:A:77:LEU:HD12	1.86	0.57
2:C:404:THR:O	2:C:406:GLU:HG3	2.04	0.57

*Continued on next page...*

*Continued from previous page...*

Atom-1	Atom-2	Interatomic distance (Å)	Clash overlap (Å)
2:D:320:VAL:O	2:D:324:ILE:HG13	2.04	0.57
2:C:70:ARG:CZ	2:C:78:LEU:CD1	2.82	0.57
2:C:491:GLY:O	2:C:495:ARG:N	2.38	0.57
2:F:55:VAL:CG1	2:F:433:LEU:HD21	2.34	0.57
1:A:239:GLU:OE1	1:A:335:GLU:OE1	2.23	0.56
2:C:506:GLU:OE1	2:D:475:LEU:HD11	2.05	0.56
1:B:217:HIS:N	1:B:217:HIS:CD2	2.72	0.56
2:D:135:VAL:HG12	2:D:135:VAL:O	2.06	0.56
2:F:396:GLU:HG3	2:F:396:GLU:O	2.05	0.56
1:B:50:ASN:HD22	1:B:52:GLY:H	1.54	0.56
2:E:441:ARG:HG3	2:E:442:ASN:N	2.20	0.56
1:A:50:ASN:HD22	1:A:52:GLY:H	1.53	0.56
2:D:414:VAL:HG12	2:D:417:LEU:HB2	1.87	0.55
1:A:78:HIS:HD2	1:A:80:GLY:H	1.54	0.55
1:A:217:HIS:CD2	1:A:217:HIS:N	2.74	0.55
2:E:146:THR:HG22	2:E:147:THR:N	2.21	0.55
1:A:462:ILE:HD12	2:C:499:VAL:HG11	1.89	0.55
2:F:38:VAL:HG21	2:F:40:TYR:CE2	2.42	0.55
1:A:66:VAL:O	1:A:70:VAL:HG23	2.06	0.55
2:D:595:VAL:HG21	2:D:615:GLN:HG3	1.88	0.55
2:C:534:SER:O	2:C:542:ARG:HG2	2.06	0.55
2:D:605:VAL:HG13	2:D:611:LEU:HD21	1.89	0.55
2:F:150:VAL:HG21	2:F:378:SER:HB2	1.87	0.54
2:F:605:VAL:HG13	2:F:611:LEU:HD21	1.89	0.54
2:C:9:VAL:HG21	2:C:239:LEU:CD1	2.36	0.54
2:C:135:VAL:HG12	2:C:135:VAL:O	2.07	0.54
2:E:421:ALA:O	2:E:424:VAL:HB	2.07	0.54
2:C:491:GLY:O	2:C:495:ARG:CB	2.55	0.54
1:B:221:ILE:HD11	1:B:322:TYR:O	2.08	0.54
2:C:494:GLN:O	2:C:496:PRO:HD3	2.08	0.54
1:A:241:ALA:CB	1:A:298:VAL:HG13	2.37	0.54
2:C:582:MET:CE	2:D:364:GLU:HG3	2.38	0.54
2:C:115:ILE:HG22	2:C:125:LEU:HD22	1.90	0.54
2:E:135:VAL:O	2:E:135:VAL:HG12	2.08	0.54
2:C:595:VAL:HG21	2:C:615:GLN:HG3	1.89	0.54
2:D:73:LEU:N	2:D:74:PRO:CD	2.71	0.53
1:B:38:HIS:O	1:B:43:LYS:HE2	2.08	0.53
2:C:430:PHE:CD1	2:C:433:LEU:HD23	2.43	0.53
2:C:423:ASP:OD2	2:C:441:ARG:NH2	2.41	0.53
3:C:2000:BTI:N2	2:D:300:MET:HG3	2.23	0.53
2:C:574:VAL:HG13	2:C:612:LEU:HD11	1.90	0.53

*Continued on next page...*

*Continued from previous page...*

Atom-1	Atom-2	Interatomic distance (Å)	Clash overlap (Å)
1:B:222:HIS:CD2	1:B:324:GLN:NE2	2.76	0.53
2:E:185:THR:HG21	2:E:214:SER:CB	2.38	0.53
2:E:476:HIS:CE1	2:F:506:GLU:HB3	2.43	0.53
1:B:222:HIS:CG	1:B:324:GLN:HE22	2.26	0.53
2:D:119:MET:CE	2:D:376:ALA:HA	2.39	0.53
2:D:119:MET:SD	2:D:368:TYR:HE2	2.31	0.53
2:E:382:PRO:O	2:E:386:ASN:N	2.35	0.53
2:F:135:VAL:HG12	2:F:135:VAL:O	2.08	0.53
2:D:323:GLU:OE2	2:D:357:ARG:NH1	2.37	0.52
2:F:562:VAL:HG12	2:F:597:ILE:HD11	1.91	0.52
1:A:301:GLN:OE1	1:A:301:GLN:HA	2.09	0.52
2:C:252:THR:HG22	2:D:183:GLN:NE2	2.25	0.52
2:D:331:LEU:HD13	2:D:368:TYR:CD1	2.44	0.52
2:E:119:MET:HE1	2:E:334:PRO:HB2	1.92	0.52
1:A:34:ASP:OD1	1:A:37:ARG:NH2	2.43	0.52
2:D:396:GLU:HG3	2:D:396:GLU:O	2.09	0.52
1:A:416:THR:HG22	1:A:417:THR:N	2.25	0.52
2:D:18:LEU:HD23	2:D:285:THR:CG2	2.39	0.52
2:F:557:ILE:HD12	2:F:575:LEU:CD2	2.40	0.51
1:B:241:ALA:CB	1:B:298:VAL:HG13	2.40	0.51
2:C:472:ASN:ND2	2:D:513:LEU:HD11	2.25	0.51
2:F:396:GLU:O	2:F:396:GLU:CG	2.58	0.51
2:D:83:ARG:O	2:D:86:ASN:HB2	2.11	0.51
2:D:557:ILE:HD12	2:D:575:LEU:CD2	2.41	0.51
2:F:24:ARG:NH2	2:F:449:GLU:O	2.44	0.51
2:C:140:GLU:OE1	2:C:201:HIS:HD2	1.93	0.51
2:D:562:VAL:HG12	2:D:597:ILE:HD11	1.91	0.51
2:E:22:ARG:CG	2:E:280:PHE:CE1	2.89	0.51
2:E:153:ILE:O	2:E:157:VAL:HG13	2.11	0.51
2:F:119:MET:SD	2:F:368:TYR:HE2	2.34	0.51
2:C:305:SER:HB3	2:C:317:MET:HE2	1.93	0.51
1:B:301:GLN:HA	1:B:301:GLN:OE1	2.10	0.51
2:C:291:VAL:HG12	2:C:291:VAL:O	2.11	0.50
2:C:119:MET:SD	2:C:368:TYR:HE2	2.34	0.50
2:C:608:ASP:OD2	2:C:608:ASP:C	2.49	0.50
2:D:176:MET:HG2	2:D:337:VAL:HG22	1.93	0.50
2:C:153:ILE:O	2:C:157:VAL:HG13	2.12	0.50
2:D:279:GLN:HE22	2:D:452:LEU:HG	1.77	0.50
2:F:88:LEU:C	2:F:429:MET:CE	2.80	0.50
2:C:88:LEU:C	2:C:429:MET:HE2	2.32	0.50
2:D:115:ILE:HG22	2:D:125:LEU:HD22	1.93	0.50

*Continued on next page...*



*Continued from previous page...*

Atom-1	Atom-2	Interatomic distance (Å)	Clash overlap (Å)
1:B:251:ARG:CZ	1:B:251:ARG:HB2	2.41	0.50
1:B:419:PRO:HB2	1:B:449:TYR:CE2	2.46	0.50
2:D:411:ARG:HB3	2:D:411:ARG:CZ	2.42	0.50
2:D:540:ARG:HG3	2:D:541:PRO:CD	2.42	0.49
2:E:5:HIS:HB3	2:E:41:TRP:HB2	1.93	0.49
1:B:277:LEU:HD21	1:B:281:ASN:HA	1.95	0.49
2:C:88:LEU:C	2:C:429:MET:CE	2.81	0.49
2:D:70:ARG:CZ	2:D:78:LEU:HD12	2.43	0.49
1:A:14:ALA:O	1:A:18:VAL:HG23	2.12	0.49
1:A:328:GLN:HB2	1:B:330:ARG:NH2	2.28	0.49
2:C:423:ASP:CG	2:C:441:ARG:NH2	2.66	0.49
1:A:254:ILE:HD13	1:A:283:PHE:CG	2.48	0.49
2:F:38:VAL:CG2	2:F:40:TYR:CD2	2.95	0.49
2:C:42:SER:OG	2:C:79:GLN:NE2	2.46	0.49
1:A:43:LYS:NZ	1:B:358:TYR:OH	2.45	0.48
1:B:62:ALA:O	1:B:66:VAL:HG23	2.13	0.48
1:B:267:TYR:CD1	1:B:288:MET:HE1	2.47	0.48
1:B:77:LEU:HD23	1:B:77:LEU:C	2.33	0.48
2:D:8:ASP:HB2	2:D:40:TYR:CE1	2.48	0.48
1:A:332:PHE:HB2	1:A:398:VAL:HG21	1.96	0.48
1:B:14:ALA:O	1:B:18:VAL:HG23	2.13	0.48
2:C:73:LEU:N	2:C:74:PRO:CD	2.76	0.48
2:D:540:ARG:HD2	2:D:598:ASN:O	2.13	0.48
2:E:102:VAL:HG21	2:E:131:SER:CB	2.44	0.48
2:D:252:THR:HG22	2:D:253:GLU:N	2.28	0.48
2:D:345:GLY:O	2:D:349:VAL:HG23	2.14	0.48
1:A:62:ALA:O	1:A:66:VAL:HG23	2.13	0.48
1:B:400:GLU:OE2	1:B:431:ARG:NH1	2.47	0.47
2:C:305:SER:CB	2:C:317:MET:CE	2.92	0.47
2:C:279:GLN:HE22	2:C:452:LEU:HG	1.79	0.47
2:E:98:VAL:O	2:E:102:VAL:HG13	2.14	0.47
2:F:8:ASP:HB2	2:F:40:TYR:CE1	2.50	0.47
2:F:70:ARG:HA	2:F:70:ARG:HD3	1.74	0.47
1:A:127:ILE:CD1	1:A:261:ALA:HB2	2.44	0.47
1:B:78:HIS:CD2	1:B:80:GLY:H	2.30	0.47
2:C:364:GLU:HG2	2:C:373:TYR:OH	2.15	0.47
2:C:513:LEU:HB2	2:D:470:GLU:HG3	1.95	0.47
2:D:175:ASP:OD2	2:D:180:LEU:HG	2.14	0.47
2:C:358:TYR:HB2	2:C:387:LEU:HD23	1.95	0.47
2:D:337:VAL:HG12	2:D:338:THR:N	2.30	0.47
1:A:96:ARG:HH12	2:F:587:GLN:HE22	1.62	0.47

*Continued on next page...*

*Continued from previous page...*

Atom-1	Atom-2	Interatomic distance (Å)	Clash overlap (Å)
1:B:332:PHE:HB2	1:B:398:VAL:HG21	1.95	0.47
2:C:362:THR:HG22	2:C:364:GLU:N	2.29	0.47
2:C:441:ARG:HD2	2:C:442:ASN:OD1	2.15	0.47
1:A:51:ILE:HG13	1:A:58:GLY:HA3	1.95	0.47
2:E:476:HIS:NE2	2:F:506:GLU:HB3	2.30	0.47
2:F:438:LEU:O	2:F:442:ASN:OD1	2.32	0.47
1:A:251:ARG:HB2	1:A:251:ARG:CZ	2.44	0.47
2:C:207:THR:CG2	2:C:288:ASP:HB3	2.44	0.47
2:C:338:THR:HG22	2:C:342:GLN:OE1	2.15	0.47
2:F:83:ARG:O	2:F:86:ASN:HB2	2.15	0.47
2:F:290:ARG:HH11	2:F:290:ARG:HB2	1.79	0.47
1:A:104:PRO:HB2	1:A:108:VAL:CG2	2.45	0.47
2:F:9:VAL:CG1	2:F:13:ASP:HB2	2.45	0.47
2:F:279:GLN:HG2	2:F:452:LEU:HD12	1.96	0.47
2:D:116:PHE:HE1	2:D:337:VAL:CG1	2.28	0.47
2:D:605:VAL:CG1	2:D:611:LEU:HD21	2.45	0.47
2:E:86:ASN:ND2	2:E:339:PRO:HG3	2.30	0.47
2:F:185:THR:HG21	2:F:214:SER:HB3	1.96	0.47
2:E:205:HIS:HD2	2:E:237:ALA:O	1.98	0.46
1:A:345:ASN:O	1:A:348:LEU:HG	2.16	0.46
1:A:419:PRO:HB2	1:A:449:TYR:CE2	2.50	0.46
2:C:232:SER:OG	2:C:267:SER:O	2.29	0.46
2:C:611:LEU:O	2:C:612:LEU:HD23	2.15	0.46
2:E:70:ARG:HA	2:E:70:ARG:HD3	1.76	0.46
2:F:177:ALA:HB3	2:F:179:LEU:HG	1.98	0.46
2:F:605:VAL:CG1	2:F:611:LEU:HD21	2.45	0.46
1:A:225:GLU:OE1	1:A:225:GLU:N	2.42	0.46
1:B:127:ILE:CD1	1:B:261:ALA:HB2	2.46	0.46
2:D:324:ILE:N	2:D:325:PRO:HD2	2.30	0.46
2:C:485:THR:HG22	2:C:486:GLY:N	2.29	0.46
2:C:514:ASN:O	2:D:469:THR:N	2.44	0.46
2:D:328:ARG:HG2	2:D:334:PRO:HD2	1.98	0.46
1:A:43:LYS:NZ	2:F:478:GLU:OE2	2.47	0.46
2:E:119:MET:CE	2:E:334:PRO:HB2	2.45	0.46
1:A:335:GLU:OE2	1:A:387:LYS:HD3	2.16	0.46
1:B:464:ALA:CB	2:F:508:VAL:HG11	2.46	0.46
2:D:18:LEU:HD23	2:D:285:THR:HG21	1.97	0.46
2:C:9:VAL:CG1	2:C:13:ASP:HB2	2.45	0.45
2:C:97:VAL:HG22	2:C:407:MET:SD	2.56	0.45
2:C:249:LEU:O	2:C:252:THR:OG1	2.34	0.45
2:C:598:ASN:ND2	2:C:610:ALA:O	2.48	0.45

*Continued on next page...*

*Continued from previous page...*

Atom-1	Atom-2	Interatomic distance (Å)	Clash overlap (Å)
2:D:218:ALA:HB1	2:D:223:VAL:HG21	1.98	0.45
2:F:279:GLN:HG2	2:F:452:LEU:HB2	1.96	0.45
2:E:8:ASP:HB2	2:E:40:TYR:CE1	2.51	0.45
2:E:254:TYR:O	2:E:255:ASP:C	2.55	0.45
2:D:140:GLU:CD	2:D:201:HIS:HD1	2.20	0.45
2:E:252:THR:HG22	2:E:253:GLU:N	2.32	0.45
2:F:592:GLY:HA3	2:F:615:GLN:O	2.16	0.45
2:E:146:THR:HG22	2:E:147:THR:H	1.81	0.45
1:A:349:PRO:HB3	1:A:351:PHE:HE2	1.80	0.45
2:C:289:THR:HG21	2:D:243:GLU:HB2	1.98	0.45
2:C:560:VAL:HA	2:C:575:LEU:HD12	1.97	0.45
2:F:254:TYR:O	2:F:255:ASP:C	2.55	0.45
2:F:474:THR:HG22	2:F:479:THR:CG2	2.37	0.45
2:D:605:VAL:HG12	2:D:606:THR:N	2.31	0.45
2:E:205:HIS:HA	2:E:239:LEU:CD2	2.47	0.45
1:A:406:LEU:HB3	1:A:418:ILE:HG23	1.98	0.45
1:B:348:LEU:HG	1:B:349:PRO:HD2	1.98	0.45
2:C:254:TYR:O	2:C:255:ASP:C	2.55	0.45
2:D:237:ALA:HB3	2:D:285:THR:HG23	1.97	0.45
2:D:591:SER:O	2:D:616:PRO:HA	2.17	0.45
2:F:5:HIS:HB3	2:F:41:TRP:HB2	1.99	0.45
2:F:414:VAL:HG12	2:F:417:LEU:HB2	1.98	0.45
2:C:70:ARG:CZ	2:C:78:LEU:HD12	2.46	0.45
2:C:582:MET:CE	2:D:343:ILE:CG1	2.95	0.45
2:C:176:MET:SD	2:C:176:MET:O	2.75	0.44
2:F:73:LEU:N	2:F:74:PRO:CD	2.80	0.44
2:C:8:ASP:HB2	2:C:40:TYR:CE1	2.52	0.44
2:E:181:THR:O	2:E:185:THR:HG23	2.18	0.44
1:A:75:ASP:OD2	1:A:75:ASP:N	2.50	0.44
2:F:88:LEU:C	2:F:429:MET:HE2	2.37	0.44
2:F:218:ALA:HB1	2:F:223:VAL:HG21	2.00	0.44
2:C:324:ILE:N	2:C:325:PRO:HD2	2.33	0.44
2:C:331:LEU:HD13	2:C:368:TYR:CD1	2.53	0.44
2:D:581:LYS:CG	2:D:581:LYS:O	2.66	0.44
2:E:73:LEU:N	2:E:74:PRO:CD	2.80	0.44
2:E:411:ARG:HG2	2:E:411:ARG:HH11	1.83	0.44
2:E:86:ASN:HA	2:E:91:ARG:O	2.18	0.44
1:A:29:VAL:HG22	1:A:47:GLU:HB2	2.00	0.44
2:C:291:VAL:O	2:C:295:GLN:HA	2.18	0.44
2:C:345:GLY:O	2:C:349:VAL:HG23	2.18	0.44
1:A:278:ASP:OD2	1:A:279:SER:N	2.51	0.44

*Continued on next page...*

*Continued from previous page...*

Atom-1	Atom-2	Interatomic distance (Å)	Clash overlap (Å)
1:B:29:VAL:HG22	1:B:47:GLU:HB2	2.00	0.44
2:D:86:ASN:HA	2:D:91:ARG:O	2.18	0.44
2:D:254:TYR:O	2:D:255:ASP:C	2.56	0.44
2:F:138:HIS:HE1	2:F:170:THR:OG1	2.01	0.44
2:C:385:ARG:HD2	2:C:394:VAL:HG21	2.00	0.43
2:C:582:MET:CE	2:D:343:ILE:HG13	2.48	0.43
2:D:221:ASN:N	2:D:221:ASN:HD22	2.16	0.43
2:E:230:ILE:HD11	2:E:266:ILE:HG13	2.00	0.43
1:B:96:ARG:HH12	2:D:587:GLN:HE22	1.66	0.43
1:B:400:GLU:OE1	1:B:403:ARG:NH1	2.51	0.43
2:C:591:SER:O	2:C:616:PRO:HA	2.18	0.43
2:D:8:ASP:HB2	2:D:40:TYR:CZ	2.53	0.43
1:A:254:ILE:HD13	1:A:283:PHE:CD2	2.54	0.43
1:A:404:ARG:HG2	1:A:405:ALA:N	2.32	0.43
1:B:75:ASP:OD2	1:B:75:ASP:N	2.52	0.43
2:C:189:VAL:CG1	2:C:223:VAL:HG23	2.47	0.43
2:C:328:ARG:HG2	2:C:334:PRO:HD2	2.01	0.43
2:D:581:LYS:O	2:D:581:LYS:HG2	2.19	0.43
1:A:335:GLU:OE2	1:A:387:LYS:CD	2.67	0.43
1:A:416:THR:HG22	1:A:418:ILE:H	1.84	0.43
2:C:5:HIS:HB3	2:C:41:TRP:HB2	2.00	0.43
2:C:441:ARG:NH1	2:C:442:ASN:OD1	2.40	0.43
2:D:573:ALA:HB2	2:D:585:GLU:OE1	2.18	0.43
2:E:34:LYS:HD3	2:E:34:LYS:N	2.34	0.43
2:E:509:VAL:HB	2:F:474:THR:OG1	2.19	0.43
1:B:226:ARG:HB3	1:B:241:ALA:HB2	1.99	0.43
2:D:411:ARG:HB3	2:D:411:ARG:NH1	2.34	0.43
1:B:298:VAL:HG23	1:B:335:GLU:HB3	2.00	0.43
2:D:5:HIS:HB3	2:D:41:TRP:HB2	2.00	0.43
1:A:324:GLN:HE21	1:A:324:GLN:HA	1.84	0.43
2:E:218:ALA:HB1	2:E:223:VAL:HG21	2.01	0.43
2:F:70:ARG:NH2	2:F:111:ASP:OD2	2.51	0.43
2:F:605:VAL:HG12	2:F:606:THR:N	2.33	0.43
2:C:83:ARG:O	2:C:86:ASN:HB2	2.19	0.42
2:C:218:ALA:HB1	2:C:223:VAL:HG21	2.00	0.42
2:E:474:THR:HA	2:E:479:THR:HA	2.01	0.42
2:C:201:HIS:HE1	2:C:227:ASP:OD1	2.02	0.42
2:D:331:LEU:HB3	2:D:368:TYR:HE1	1.82	0.42
2:F:221:ASN:N	2:F:221:ASN:HD22	2.18	0.42
2:C:452:LEU:HD13	2:C:457:VAL:HG21	2.02	0.42
2:D:83:ARG:HG2	2:D:116:PHE:CZ	2.54	0.42

*Continued on next page...*

*Continued from previous page...*

Atom-1	Atom-2	Interatomic distance (Å)	Clash overlap (Å)
1:B:406:LEU:HB3	1:B:418:ILE:HG23	2.01	0.42
2:D:284:PHE:HE2	2:D:314:LEU:HD22	1.84	0.42
2:E:3:LYS:O	2:E:3:LYS:HG3	2.18	0.42
1:B:222:HIS:NE2	1:B:324:GLN:NE2	2.68	0.42
2:C:582:MET:HE3	2:D:343:ILE:HG12	2.01	0.42
2:D:176:MET:SD	2:D:337:VAL:CG2	3.08	0.42
2:E:324:ILE:N	2:E:325:PRO:HD2	2.34	0.42
2:F:35:LEU:O	2:F:38:VAL:HG22	2.19	0.42
2:F:86:ASN:HA	2:F:91:ARG:O	2.19	0.42
2:C:59:ARG:HD3	2:C:59:ARG:HA	1.72	0.42
2:D:176:MET:HB2	2:D:297:PRO:HB3	2.02	0.42
2:E:253:GLU:O	2:E:253:GLU:HG2	2.20	0.42
2:C:474:THR:HA	2:C:479:THR:HA	2.02	0.42
2:E:221:ASN:N	2:E:221:ASN:HD22	2.18	0.42
1:A:340:ALA:HB2	1:A:385:CYS:SG	2.59	0.42
2:E:70:ARG:NH2	2:E:111:ASP:OD2	2.52	0.42
2:F:8:ASP:HB2	2:F:40:TYR:CZ	2.54	0.42
1:A:7:ILE:HG21	1:A:14:ALA:HA	2.02	0.41
1:A:78:HIS:CD2	1:A:80:GLY:H	2.35	0.41
1:A:91:ALA:HB3	1:A:106:ALA:HB2	2.00	0.41
2:C:535:ALA:C	2:C:542:ARG:HD3	2.40	0.41
2:E:350:LEU:O	2:E:353:MET:N	2.53	0.41
2:F:9:VAL:HG23	2:F:228:GLY:O	2.20	0.41
2:F:414:VAL:HG12	2:F:414:VAL:O	2.19	0.41
1:B:350:SER:O	1:B:414:VAL:HG13	2.19	0.41
2:C:305:SER:HB3	2:C:317:MET:HE1	2.02	0.41
2:D:557:ILE:HD13	2:D:577:ILE:HD13	2.01	0.41
1:B:225:GLU:OE1	1:B:225:GLU:N	2.46	0.41
1:B:254:ILE:HD13	1:B:283:PHE:CG	2.55	0.41
1:B:298:VAL:O	1:B:301:GLN:HB2	2.21	0.41
1:B:301:GLN:NE2	1:B:366:ARG:HD2	2.34	0.41
2:C:175:ASP:OD2	2:C:180:LEU:HG	2.20	0.41
2:E:119:MET:CE	2:E:334:PRO:CB	2.98	0.41
2:E:201:HIS:HE1	2:E:227:ASP:OD1	2.04	0.41
2:F:573:ALA:HB2	2:F:585:GLU:OE1	2.20	0.41
1:B:293:GLN:O	1:B:294:VAL:C	2.58	0.41
2:C:56:ARG:HD2	2:C:57:TYR:CZ	2.56	0.41
2:C:331:LEU:HD23	2:C:331:LEU:N	2.35	0.41
2:D:148:SER:HG	2:D:151:HIS:CE1	2.33	0.41
2:D:250:LYS:HA	2:D:255:ASP:OD2	2.20	0.41
1:A:350:SER:O	1:A:414:VAL:HG13	2.21	0.41

*Continued on next page...*

Continued from previous page...

Atom-1	Atom-2	Interatomic distance (Å)	Clash overlap (Å)
2:E:153:ILE:CB	2:E:188:LEU:CD2	2.98	0.41
2:E:411:ARG:HH11	2:E:411:ARG:CG	2.34	0.41
1:B:206:ARG:CZ	1:B:277:LEU:HD22	2.50	0.41
1:B:340:ALA:HB2	1:B:385:CYS:SG	2.61	0.41
2:C:153:ILE:N	2:C:154:PRO:HD2	2.36	0.41
1:B:31:ILE:O	1:B:31:ILE:HG13	2.20	0.41
1:B:335:GLU:HB3	1:B:389:THR:HG23	2.03	0.41
2:C:86:ASN:HA	2:C:91:ARG:O	2.21	0.41
2:C:337:VAL:HG12	2:C:338:THR:N	2.36	0.41
2:C:584:ASN:HD22	2:C:584:ASN:HA	1.65	0.41
2:D:155:TYR:CD2	2:D:155:TYR:C	2.94	0.41
2:F:9:VAL:CG1	2:F:13:ASP:CB	2.99	0.41
1:A:31:ILE:O	1:A:31:ILE:HG13	2.19	0.41
1:B:7:ILE:HG21	1:B:14:ALA:HA	2.02	0.41
1:B:382:ASP:OD1	1:B:382:ASP:C	2.59	0.41
2:C:310:GLU:CD	2:D:541:PRO:HG3	2.42	0.41
1:A:362:GLY:HA2	1:B:366:ARG:HE	1.86	0.40
1:B:345:ASN:O	1:B:346:ASP:C	2.58	0.40
2:D:324:ILE:N	2:D:325:PRO:CD	2.84	0.40
2:D:323:GLU:OE2	2:D:357:ARG:HD2	2.21	0.40
2:C:291:VAL:HG22	2:C:298:GLY:H	1.86	0.40
2:C:300:MET:HE2	2:C:324:ILE:HD13	2.01	0.40
2:C:536:ALA:N	2:C:542:ARG:HD3	2.36	0.40
2:D:70:ARG:NH1	2:D:78:LEU:HD12	2.36	0.40
2:D:297:PRO:HG3	2:D:336:LEU:O	2.21	0.40
2:D:354:THR:HG21	2:D:359:LYS:HB3	2.02	0.40
1:A:427:HIS:CE1	1:A:429:ASP:HB2	2.57	0.40
1:A:16:ARG:O	1:A:19:ARG:HB2	2.22	0.40
1:A:462:ILE:HD11	2:C:501:VAL:CG2	2.52	0.40
1:B:327:VAL:O	1:B:327:VAL:HG23	2.22	0.40
2:C:582:MET:HE1	2:D:343:ILE:HG13	2.02	0.40
2:D:232:SER:OG	2:D:267:SER:O	2.30	0.40
2:D:381:ASN:HA	2:D:382:PRO:HD3	1.95	0.40
2:F:12:ARG:NE	2:F:44:GLU:OE2	2.49	0.40

All (1) symmetry-related close contacts are listed below. The label for Atom-2 includes the symmetry operator and encoded unit-cell translations to be applied.

Atom-1	Atom-2	Interatomic distance (Å)	Clash overlap (Å)
2:E:149:PRO:O	2:F:193:ARG:NH2[4_555]	2.07	0.13

## 5.3 Torsion angles [i](#)

### 5.3.1 Protein backbone [i](#)

In the following table, the Percentiles column shows the percent Ramachandran outliers of the chain as a percentile score with respect to all X-ray entries followed by that with respect to entries of similar resolution.

The Analysed column shows the number of residues for which the backbone conformation was analysed, and the total number of residues.

Mol	Chain	Analysed	Favoured	Allowed	Outliers	Percentiles	
1	A	402/405 (99%)	375 (93%)	27 (7%)	0	100	100
1	B	402/405 (99%)	372 (92%)	30 (8%)	0	100	100
2	C	599/617 (97%)	572 (96%)	27 (4%)	0	100	100
2	D	574/617 (93%)	553 (96%)	21 (4%)	0	100	100
2	E	416/617 (67%)	397 (95%)	19 (5%)	0	100	100
2	F	468/617 (76%)	445 (95%)	23 (5%)	0	100	100
All	All	2861/3278 (87%)	2714 (95%)	147 (5%)	0	100	100

There are no Ramachandran outliers to report.

### 5.3.2 Protein sidechains [i](#)

In the following table, the Percentiles column shows the percent sidechain outliers of the chain as a percentile score with respect to all X-ray entries followed by that with respect to entries of similar resolution.

The Analysed column shows the number of residues for which the sidechain conformation was analysed, and the total number of residues.

Mol	Chain	Analysed	Rotameric	Outliers	Percentiles	
1	A	327/332 (98%)	314 (96%)	13 (4%)	31	67
1	B	329/332 (99%)	312 (95%)	17 (5%)	23	57
2	C	491/513 (96%)	455 (93%)	36 (7%)	14	43
2	D	479/513 (93%)	455 (95%)	24 (5%)	24	59
2	E	242/513 (47%)	224 (93%)	18 (7%)	13	42
2	F	360/513 (70%)	333 (92%)	27 (8%)	13	42
All	All	2228/2716 (82%)	2093 (94%)	135 (6%)	18	51

All (135) residues with a non-rotameric sidechain are listed below:

Mol	Chain	Res	Type
1	A	6	LEU
1	A	43	LYS
1	A	50	ASN
1	A	53	SER
1	A	75	ASP
1	A	216	SER
1	A	268	LYS
1	A	298	VAL
1	A	299	THR
1	A	301	GLN
1	A	319	ARG
1	A	407	ASN
1	A	423	GLU
1	B	6	LEU
1	B	50	ASN
1	B	53	SER
1	B	75	ASP
1	B	102	ILE
1	B	115	LYS
1	B	216	SER
1	B	221	ILE
1	B	226	ARG
1	B	252	GLU
1	B	268	LYS
1	B	298	VAL
1	B	299	THR
1	B	328	GLN
1	B	335	GLU
1	B	407	ASN
1	B	423	GLU
2	C	7	THR
2	C	10	VAL
2	C	46	TRP
2	C	95	ASP
2	C	146	THR
2	C	157	VAL
2	C	230	ILE
2	C	232	SER
2	C	353	MET
2	C	363	ASN
2	C	364	GLU
2	C	375	LYS

*Continued on next page...*



*Continued from previous page...*

<b>Mol</b>	<b>Chain</b>	<b>Res</b>	<b>Type</b>
2	C	383	ASP
2	C	389	VAL
2	C	391	ASN
2	C	404	THR
2	C	415	GLU
2	C	430	PHE
2	C	438	LEU
2	C	446	LEU
2	C	447	LYS
2	C	449	GLU
2	C	472	ASN
2	C	529	LYS
2	C	531	LYS
2	C	542	ARG
2	C	562	VAL
2	C	563	ASN
2	C	566	ASP
2	C	569	SER
2	C	574	VAL
2	C	575	LEU
2	C	584	ASN
2	C	587	GLN
2	C	598	ASN
2	C	608	ASP
2	D	10	VAL
2	D	46	TRP
2	D	95	ASP
2	D	176	MET
2	D	190	LYS
2	D	221	ASN
2	D	230	ILE
2	D	232	SER
2	D	293	VAL
2	D	338	THR
2	D	353	MET
2	D	375	LYS
2	D	386	ASN
2	D	389	VAL
2	D	404	THR
2	D	430	PHE
2	D	449	GLU
2	D	479	THR

*Continued on next page...*

*Continued from previous page...*

<b>Mol</b>	<b>Chain</b>	<b>Res</b>	<b>Type</b>
2	D	540	ARG
2	D	569	SER
2	D	574	VAL
2	D	575	LEU
2	D	581	LYS
2	D	582	MET
2	E	31	ILE
2	E	70	ARG
2	E	99	ARG
2	E	104	LYS
2	E	117	ASP
2	E	119	MET
2	E	157	VAL
2	E	163	LEU
2	E	188	LEU
2	E	230	ILE
2	E	232	SER
2	E	381	ASN
2	E	411	ARG
2	E	430	PHE
2	E	438	LEU
2	E	479	THR
2	E	484	LEU
2	E	511	GLU
2	F	10	VAL
2	F	46	TRP
2	F	70	ARG
2	F	95	ASP
2	F	104	LYS
2	F	119	MET
2	F	133	LYS
2	F	221	ASN
2	F	230	ILE
2	F	243	GLU
2	F	381	ASN
2	F	404	THR
2	F	408	GLU
2	F	430	PHE
2	F	442	ASN
2	F	449	GLU
2	F	470	GLU
2	F	540	ARG

*Continued on next page...*

*Continued from previous page...*

<b>Mol</b>	<b>Chain</b>	<b>Res</b>	<b>Type</b>
2	F	545	HIS
2	F	563	ASN
2	F	569	SER
2	F	574	VAL
2	F	575	LEU
2	F	580	MET
2	F	582	MET
2	F	612	LEU
2	F	615	GLN

Sometimes sidechains can be flipped to improve hydrogen bonding and reduce clashes. All (54) such sidechains are listed below:

<b>Mol</b>	<b>Chain</b>	<b>Res</b>	<b>Type</b>
1	A	50	ASN
1	A	78	HIS
1	A	117	GLN
1	A	219	ASN
1	A	234	ASN
1	A	245	GLN
1	A	309	GLN
1	A	318	GLN
1	A	328	GLN
1	A	339	ASN
1	A	407	ASN
1	A	443	HIS
1	A	448	ASN
1	B	38	HIS
1	B	50	ASN
1	B	61	ASN
1	B	78	HIS
1	B	117	GLN
1	B	217	HIS
1	B	219	ASN
1	B	245	GLN
1	B	282	ASN
1	B	309	GLN
1	B	318	GLN
1	B	324	GLN
1	B	328	GLN
1	B	339	ASN
1	B	407	ASN
1	B	443	HIS

*Continued on next page...*

*Continued from previous page...*

Mol	Chain	Res	Type
2	C	79	GLN
2	C	92	HIS
2	C	201	HIS
2	C	264	GLN
2	C	279	GLN
2	C	311	GLN
2	C	391	ASN
2	C	472	ASN
2	C	584	ASN
2	C	598	ASN
2	D	86	ASN
2	D	183	GLN
2	D	221	ASN
2	D	279	GLN
2	D	587	GLN
2	E	86	ASN
2	E	201	HIS
2	E	205	HIS
2	E	221	ASN
2	E	381	ASN
2	F	138	HIS
2	F	183	GLN
2	F	201	HIS
2	F	221	ASN
2	F	587	GLN

### 5.3.3 RNA [i](#)

There are no RNA molecules in this entry.

### 5.4 Non-standard residues in protein, DNA, RNA chains [i](#)

There are no non-standard protein/DNA/RNA residues in this entry.

### 5.5 Carbohydrates [i](#)

There are no monosaccharides in this entry.

## 5.6 Ligand geometry [i](#)

Of 6 ligands modelled in this entry, 3 are monoatomic - leaving 3 for Mogul analysis.

In the following table, the Counts columns list the number of bonds (or angles) for which Mogul statistics could be retrieved, the number of bonds (or angles) that are observed in the model and the number of bonds (or angles) that are defined in the Chemical Component Dictionary. The Link column lists molecule types, if any, to which the group is linked. The Z score for a bond length (or angle) is the number of standard deviations the observed value is removed from the expected value. A bond length (or angle) with  $|Z| > 2$  is considered an outlier worth inspection. RMSZ is the root-mean-square of all Z scores of the bond lengths (or angles).

Mol	Type	Chain	Res	Link	Bond lengths			Bond angles		
					Counts	RMSZ	# Z  > 2	Counts	RMSZ	# Z  > 2
3	BTI	C	2000	2	16,16,16	1.80	1 (6%)	21,21,21	2.88	10 (47%)
4	PYR	D	2001	-	5,5,5	1.63	2 (40%)	3,6,6	2.19	1 (33%)
4	PYR	C	2001	-	5,5,5	1.27	0	3,6,6	1.59	1 (33%)

In the following table, the Chirals column lists the number of chiral outliers, the number of chiral centers analysed, the number of these observed in the model and the number defined in the Chemical Component Dictionary. Similar counts are reported in the Torsion and Rings columns. '-' means no outliers of that kind were identified.

Mol	Type	Chain	Res	Link	Chirals	Torsions	Rings
3	BTI	C	2000	2	-	1/5/27/27	0/2/2/2
4	PYR	D	2001	-	-	2/4/4/4	-
4	PYR	C	2001	-	-	3/4/4/4	-

All (3) bond length outliers are listed below:

Mol	Chain	Res	Type	Atoms	Z	Observed(Å)	Ideal(Å)
3	C	2000	BTI	C2-S1	-6.37	1.72	1.82
4	D	2001	PYR	CB-CA	2.21	1.54	1.50
4	D	2001	PYR	OXT-C	-2.17	1.24	1.30

All (12) bond angle outliers are listed below:

Mol	Chain	Res	Type	Atoms	Z	Observed(°)	Ideal(°)
3	C	2000	BTI	C2-C4-N2	6.45	118.91	113.13
3	C	2000	BTI	C4-C2-S1	-6.15	99.35	105.20
3	C	2000	BTI	C6-S1-C2	4.94	100.04	89.89
3	C	2000	BTI	C5-C6-S1	-4.70	102.28	106.31
3	C	2000	BTI	C6-C5-N3	-3.37	108.74	113.03
4	D	2001	PYR	OXT-C-O	-3.28	116.09	123.61

*Continued on next page...*

*Continued from previous page...*

Mol	Chain	Res	Type	Atoms	Z	Observed(°)	Ideal(°)
3	C	2000	BTI	O3-C3-N3	-2.63	122.16	125.94
3	C	2000	BTI	C2-C4-C5	2.18	111.47	108.94
4	C	2001	PYR	OXT-C-CA	2.15	119.84	113.97
3	C	2000	BTI	C4-C5-N3	2.09	104.65	102.43
3	C	2000	BTI	N2-C3-N3	2.08	110.71	108.76
3	C	2000	BTI	C6-C5-C4	2.03	110.42	108.66

There are no chirality outliers.

All (6) torsion outliers are listed below:

Mol	Chain	Res	Type	Atoms
4	C	2001	PYR	O-C-CA-CB
4	C	2001	PYR	OXT-C-CA-O3
4	C	2001	PYR	OXT-C-CA-CB
4	D	2001	PYR	O-C-CA-CB
4	D	2001	PYR	OXT-C-CA-CB
3	C	2000	BTI	C7-C8-C9-C10

There are no ring outliers.

1 monomer is involved in 1 short contact:

Mol	Chain	Res	Type	Clashes	Symm-Clashes
3	C	2000	BTI	1	0

## 5.7 Other polymers [i](#)

There are no such residues in this entry.

## 5.8 Polymer linkage issues [i](#)

There are no chain breaks in this entry.

## 6 Fit of model and data

### 6.1 Protein, DNA and RNA chains

In the following table, the column labelled ‘#RSRZ> 2’ contains the number (and percentage) of RSRZ outliers, followed by percent RSRZ outliers for the chain as percentile scores relative to all X-ray entries and entries of similar resolution. The OWAB column contains the minimum, median, 95<sup>th</sup> percentile and maximum values of the occupancy-weighted average B-factor per residue. The column labelled ‘Q< 0.9’ lists the number of (and percentage) of residues with an average occupancy less than 0.9.

Mol	Chain	Analysed	<RSRZ>	#RSRZ>2	OWAB(Å <sup>2</sup> )	Q<0.9
1	A	404/405 (99%)	-0.17	0 <b>100</b> <b>100</b>	55, 94, 126, 158	0
1	B	404/405 (99%)	-0.34	2 (0%) <b>91</b> <b>75</b>	54, 78, 132, 198	0
2	C	603/617 (97%)	-0.33	3 (0%) <b>91</b> <b>75</b>	52, 94, 137, 214	0
2	D	580/617 (94%)	-0.37	3 (0%) <b>91</b> <b>75</b>	47, 74, 138, 194	0
2	E	430/617 (69%)	0.63	60 (13%) <b>2</b> <b>1</b>	95, 169, 222, 253	0
2	F	482/617 (78%)	0.58	66 (13%) <b>3</b> <b>1</b>	97, 156, 196, 229	0
All	All	2903/3278 (88%)	-0.02	134 (4%) <b>32</b> <b>12</b>	47, 101, 191, 253	0

All (134) RSRZ outliers are listed below:

Mol	Chain	Res	Type	RSRZ
2	F	510	VAL	6.5
2	F	372	HIS	6.1
2	F	374	GLY	6.0
2	F	8	ASP	5.7
2	E	85	GLN	5.5
2	F	195	ALA	5.4
2	F	197	SER	5.2
2	E	199	PRO	5.0
2	E	96	ASP	4.7
1	B	468	ALA	4.6
2	F	380	VAL	4.5
2	E	128	SER	4.4
2	F	285	THR	4.4
2	E	46	TRP	4.4
2	F	140	GLU	4.1
2	E	399	PRO	4.1
2	E	372	HIS	4.1
2	F	167	GLY	4.1
2	E	7	THR	4.0

*Continued on next page...*

*Continued from previous page...*

<b>Mol</b>	<b>Chain</b>	<b>Res</b>	<b>Type</b>	<b>RSRZ</b>
2	F	148	SER	4.0
2	E	166	PHE	4.0
2	E	81	LEU	3.9
2	E	127	VAL	3.9
2	E	78	LEU	3.9
2	E	191	ALA	3.9
2	F	194	GLU	3.9
2	E	194	GLU	3.7
2	E	5	HIS	3.7
2	E	93	TYR	3.7
2	E	223	VAL	3.6
2	F	443	ALA	3.6
2	F	444	GLY	3.6
2	F	511	GLU	3.6
2	F	150	VAL	3.5
2	F	445	SER	3.5
2	F	78	LEU	3.5
2	E	222	GLY	3.5
2	F	199	PRO	3.5
2	C	488	GLY	3.4
2	F	373	TYR	3.4
2	F	145	TYR	3.4
2	E	163	LEU	3.4
2	E	373	TYR	3.4
2	E	80	MET	3.3
2	E	167	GLY	3.3
2	E	195	ALA	3.3
2	D	460	ARG	3.3
2	E	45	ALA	3.2
2	E	95	ASP	3.2
2	F	451	LEU	3.2
2	E	79	GLN	3.2
2	F	144	SER	3.2
2	F	448	PRO	3.1
2	E	4	VAL	3.1
2	F	286	GLY	3.0
2	E	41	TRP	3.0
2	E	397	CYS	3.0
2	F	277	TYR	3.0
2	F	371	GLY	3.0
2	F	369	LEU	2.9
2	F	377	PRO	2.9

*Continued on next page...*



*Continued from previous page...*

<b>Mol</b>	<b>Chain</b>	<b>Res</b>	<b>Type</b>	<b>RSRZ</b>
2	E	211	ALA	2.9
2	E	147	THR	2.9
2	F	224	ALA	2.9
2	F	200	ILE	2.8
2	E	139	ALA	2.8
2	E	255	ASP	2.8
2	F	417	LEU	2.8
2	E	171	ILE	2.8
2	F	75	ASN	2.8
2	F	378	SER	2.8
2	E	469	THR	2.7
2	E	485	THR	2.7
2	F	386	ASN	2.7
2	E	369	LEU	2.6
2	E	403	LEU	2.6
2	E	125	LEU	2.6
2	F	143	ILE	2.5
2	E	200	ILE	2.5
2	E	428	ALA	2.5
2	F	63	TRP	2.5
2	F	446	LEU	2.5
2	F	27	ASP	2.5
2	E	129	ILE	2.4
2	E	169	ASP	2.4
2	F	10	VAL	2.4
2	E	473	VAL	2.4
2	F	57	TYR	2.4
2	F	600	LYS	2.4
2	F	151	HIS	2.4
2	E	380	VAL	2.4
2	F	382	PRO	2.4
2	E	354	THR	2.4
2	F	447	LYS	2.4
2	F	485	THR	2.3
2	F	595	VAL	2.3
2	E	480	PHE	2.3
2	E	501	VAL	2.3
2	F	604	SER	2.3
2	C	489	HIS	2.3
2	E	132	VAL	2.3
2	E	42	SER	2.3
2	F	89	GLY	2.3

*Continued on next page...*

*Continued from previous page...*

Mol	Chain	Res	Type	RSRZ
2	F	450	PRO	2.3
2	E	84	GLY	2.2
2	F	228	GLY	2.2
2	E	379	THR	2.2
2	F	185	THR	2.2
2	F	370	LEU	2.2
2	F	512	ILE	2.2
2	F	198	LEU	2.2
2	E	181	THR	2.2
2	F	46	TRP	2.2
2	E	335	PRO	2.2
2	F	555	GLY	2.2
2	E	401	ASP	2.2
2	C	532	ALA	2.2
2	F	513	LEU	2.2
1	B	471	GLY	2.2
2	D	509	VAL	2.1
2	F	149	PRO	2.1
2	E	124	ASN	2.1
2	E	340	THR	2.1
2	F	508	VAL	2.1
2	F	509	VAL	2.1
2	F	395	ILE	2.1
2	F	122	LEU	2.1
2	F	484	LEU	2.1
2	F	363	ASN	2.1
2	F	72	ALA	2.1
2	D	485	THR	2.1
2	E	494	GLN	2.0
2	E	136	GLY	2.0
2	E	159	LEU	2.0

## 6.2 Non-standard residues in protein, DNA, RNA chains [i](#)

There are no non-standard protein/DNA/RNA residues in this entry.

## 6.3 Carbohydrates [i](#)

There are no monosaccharides in this entry.

## 6.4 Ligands [i](#)

In the following table, the Atoms column lists the number of modelled atoms in the group and the number defined in the chemical component dictionary. The B-factors column lists the minimum, median, 95<sup>th</sup> percentile and maximum values of B factors of atoms in the group. The column labelled 'Q< 0.9' lists the number of atoms with occupancy less than 0.9.

Mol	Type	Chain	Res	Atoms	RSCC	RSR	B-factors( $\text{\AA}^2$ )	Q<0.9
4	PYR	C	2001	6/6	0.87	0.24	84,98,101,101	0
5	MN	F	701	1/1	0.88	0.07	164,164,164,164	0
4	PYR	D	2001	6/6	0.90	0.25	64,71,72,73	0
3	BTI	C	2000	15/15	0.98	0.21	54,60,81,91	0
5	MN	D	2002	1/1	0.99	0.28	64,64,64,64	0
5	MN	C	2002	1/1	0.99	0.20	92,92,92,92	0

## 6.5 Other polymers [i](#)

There are no such residues in this entry.