



Full wwPDB X-ray Structure Validation Report ⓘ

Jun 17, 2024 – 07:33 AM EDT

PDB ID : 5JSZ
Title : Folate ECF transporter: apo state
Authors : Swier, L.J.Y.M.; Guskov, A.; Slotboom, D.J.
Deposited on : 2016-05-09
Resolution : 3.00 Å(reported)

This is a Full wwPDB X-ray Structure Validation Report for a publicly released PDB entry.

We welcome your comments at validation@mail.wwpdb.org

A user guide is available at

<https://www.wwpdb.org/validation/2017/XrayValidationReportHelp>

with specific help available everywhere you see the ⓘ symbol.

The types of validation reports are described at

<http://www.wwpdb.org/validation/2017/FAQs#types>.

The following versions of software and data (see [references ⓘ](#)) were used in the production of this report:

MolProbity : 4.02b-467
Xtrriage (Phenix) : 1.13
EDS : 2.37.1
Percentile statistics : 20191225.v01 (using entries in the PDB archive December 25th 2019)
Refmac : 5.8.0158
CCP4 : 7.0.044 (Gargrove)
Ideal geometry (proteins) : Engh & Huber (2001)
Ideal geometry (DNA, RNA) : Parkinson et al. (1996)
Validation Pipeline (wwPDB-VP) : 2.37.1

1 Overall quality at a glance

The following experimental techniques were used to determine the structure:

X-RAY DIFFRACTION

The reported resolution of this entry is 3.00 Å.

Percentile scores (ranging between 0-100) for global validation metrics of the entry are shown in the following graphic. The table shows the number of entries on which the scores are based.

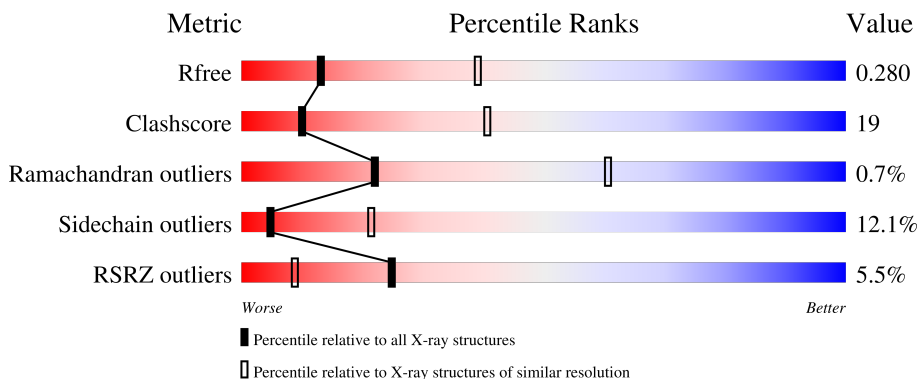



Metric	Whole archive (#Entries)	Similar resolution (#Entries, resolution range(Å))
R_{free}	130704	2092 (3.00-3.00)
Clashscore	141614	2416 (3.00-3.00)
Ramachandran outliers	138981	2333 (3.00-3.00)
Sidechain outliers	138945	2336 (3.00-3.00)
RSRZ outliers	127900	1990 (3.00-3.00)

The table below summarises the geometric issues observed across the polymeric chains and their fit to the electron density. The red, orange, yellow and green segments of the lower bar indicate the fraction of residues that contain outliers for ≥ 3 , 2, 1 and 0 types of geometric quality criteria respectively. A grey segment represents the fraction of residues that are not modelled. The numeric value for each fraction is indicated below the corresponding segment, with a dot representing fractions $\leq 5\%$. The upper red bar (where present) indicates the fraction of residues that have poor fit to the electron density. The numeric value is given above the bar.

Mol	Chain	Length	Quality of chain
1	A	300	 4% 54% 35% 7%
1	E	300	 3% 51% 35% 7% 7%
2	B	287	 61% 34% 5%
2	F	287	 2% 62% 33% 3%
3	C	184	 9% 44% 40% 5% 10%

Continued on next page...

Continued from previous page...

Mol	Chain	Length	Quality of chain
3	G	184	
4	D	265	
4	H	265	

2 Entry composition [i](#)

There are 4 unique types of molecules in this entry. The entry contains 15394 atoms, of which 0 are hydrogens and 0 are deuteriums.

In the tables below, the ZeroOcc column contains the number of atoms modelled with zero occupancy, the AltConf column contains the number of residues with at least one atom in alternate conformation and the Trace column contains the number of residues modelled with at most 2 atoms.

- Molecule 1 is a protein called Energy-coupling factor transporter ATP-binding protein EcfA1.

Mol	Chain	Residues	Atoms					ZeroOcc	AltConf	Trace
			Total	C	N	O	S			
1	A	280	2147	1354	359	430	4	0	0	0
1	E	280	2147	1354	359	430	4	0	0	0

There are 38 discrepancies between the modelled and reference sequences:

Chain	Residue	Modelled	Actual	Comment	Reference
A	-17	MET	-	initiating methionine	UNP Q1GBJ0
A	-16	HIS	-	expression tag	UNP Q1GBJ0
A	-15	HIS	-	expression tag	UNP Q1GBJ0
A	-14	HIS	-	expression tag	UNP Q1GBJ0
A	-13	HIS	-	expression tag	UNP Q1GBJ0
A	-12	HIS	-	expression tag	UNP Q1GBJ0
A	-11	HIS	-	expression tag	UNP Q1GBJ0
A	-10	HIS	-	expression tag	UNP Q1GBJ0
A	-9	HIS	-	expression tag	UNP Q1GBJ0
A	-8	HIS	-	expression tag	UNP Q1GBJ0
A	-7	HIS	-	expression tag	UNP Q1GBJ0
A	-6	GLY	-	expression tag	UNP Q1GBJ0
A	-5	GLU	-	expression tag	UNP Q1GBJ0
A	-4	ASN	-	expression tag	UNP Q1GBJ0
A	-3	LEU	-	expression tag	UNP Q1GBJ0
A	-2	TYR	-	expression tag	UNP Q1GBJ0
A	-1	PHE	-	expression tag	UNP Q1GBJ0
A	0	GLN	-	expression tag	UNP Q1GBJ0
A	1	GLY	-	expression tag	UNP Q1GBJ0
E	-17	MET	-	initiating methionine	UNP Q1GBJ0
E	-16	HIS	-	expression tag	UNP Q1GBJ0
E	-15	HIS	-	expression tag	UNP Q1GBJ0
E	-14	HIS	-	expression tag	UNP Q1GBJ0
E	-13	HIS	-	expression tag	UNP Q1GBJ0
E	-12	HIS	-	expression tag	UNP Q1GBJ0

Continued on next page...

Continued from previous page...

Chain	Residue	Modelled	Actual	Comment	Reference
E	-11	HIS	-	expression tag	UNP Q1GBJ0
E	-10	HIS	-	expression tag	UNP Q1GBJ0
E	-9	HIS	-	expression tag	UNP Q1GBJ0
E	-8	HIS	-	expression tag	UNP Q1GBJ0
E	-7	HIS	-	expression tag	UNP Q1GBJ0
E	-6	GLY	-	expression tag	UNP Q1GBJ0
E	-5	GLU	-	expression tag	UNP Q1GBJ0
E	-4	ASN	-	expression tag	UNP Q1GBJ0
E	-3	LEU	-	expression tag	UNP Q1GBJ0
E	-2	TYR	-	expression tag	UNP Q1GBJ0
E	-1	PHE	-	expression tag	UNP Q1GBJ0
E	0	GLN	-	expression tag	UNP Q1GBJ0
E	1	GLY	-	expression tag	UNP Q1GBJ0

- Molecule 2 is a protein called Energy-coupling factor transporter ATP-binding protein EcfA2.

Mol	Chain	Residues	Atoms					ZeroOcc	AltConf	Trace
			Total	C	N	O	S			
2	B	282	2191	1399	371	412	9	0	0	0
2	F	282	2191	1399	371	412	9	0	0	0

- Molecule 3 is a protein called Conserved hypothetical membrane protein.

Mol	Chain	Residues	Atoms					ZeroOcc	AltConf	Trace
			Total	C	N	O	S			
3	C	165	1276	861	199	206	10	0	0	0
3	G	165	1276	861	199	206	10	0	0	0

There are 16 discrepancies between the modelled and reference sequences:

Chain	Residue	Modelled	Actual	Comment	Reference
C	177	TRP	-	expression tag	UNP Q1G929
C	178	SER	-	expression tag	UNP Q1G929
C	179	HIS	-	expression tag	UNP Q1G929
C	180	PRO	-	expression tag	UNP Q1G929
C	181	GLN	-	expression tag	UNP Q1G929
C	182	PHE	-	expression tag	UNP Q1G929
C	183	GLU	-	expression tag	UNP Q1G929
C	184	LYS	-	expression tag	UNP Q1G929
G	177	TRP	-	expression tag	UNP Q1G929

Continued on next page...

Continued from previous page...

Chain	Residue	Modelled	Actual	Comment	Reference
G	178	SER	-	expression tag	UNP Q1G929
G	179	HIS	-	expression tag	UNP Q1G929
G	180	PRO	-	expression tag	UNP Q1G929
G	181	GLN	-	expression tag	UNP Q1G929
G	182	PHE	-	expression tag	UNP Q1G929
G	183	GLU	-	expression tag	UNP Q1G929
G	184	LYS	-	expression tag	UNP Q1G929

- Molecule 4 is a protein called Energy-coupling factor transporter transmembrane protein EcfT.

Mol	Chain	Residues	Atoms					ZeroOcc	AltConf	Trace
			Total	C	N	O	S			
4	D	259	Total	C	N	O	S	0	0	0
			2083	1391	333	345	14			
4	H	259	Total	C	N	O	S	0	0	0
			2083	1391	333	345	14			

3 Residue-property plots i

These plots are drawn for all protein, RNA, DNA and oligosaccharide chains in the entry. The first graphic for a chain summarises the proportions of the various outlier classes displayed in the second graphic. The second graphic shows the sequence view annotated by issues in geometry and electron density. Residues are color-coded according to the number of geometric quality criteria for which they contain at least one outlier: green = 0, yellow = 1, orange = 2 and red = 3 or more. A red dot above a residue indicates a poor fit to the electron density ($RSRZ > 2$). Stretches of 2 or more consecutive residues without any outlier are shown as a green connector. Residues present in the sample, but not in the model, are shown in grey.

- Molecule 1: Energy-coupling factor transporter ATP-binding protein EcfA1

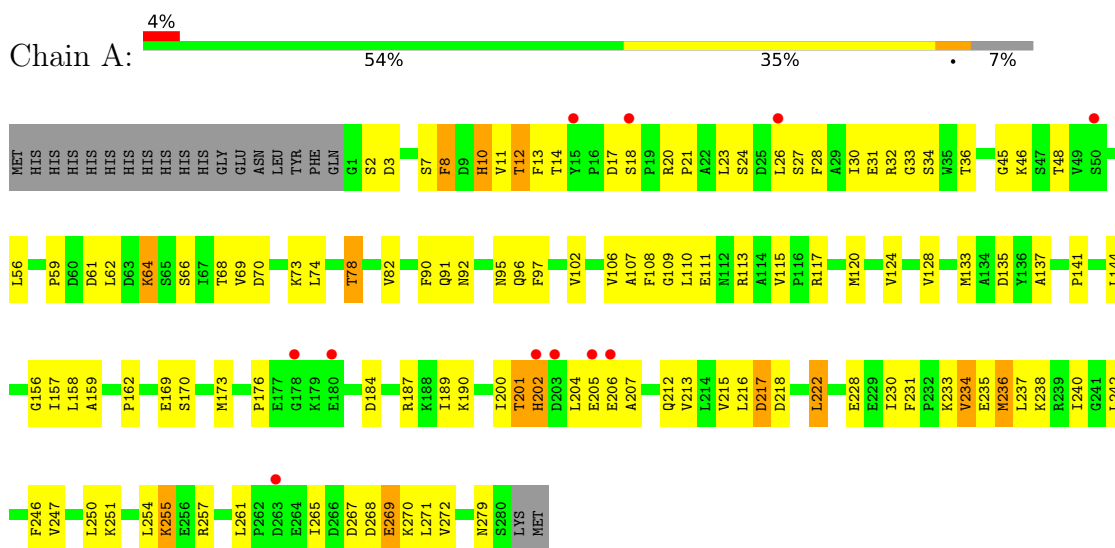

- Molecule 1: Energy-coupling factor transporter ATP-binding protein EcfA1

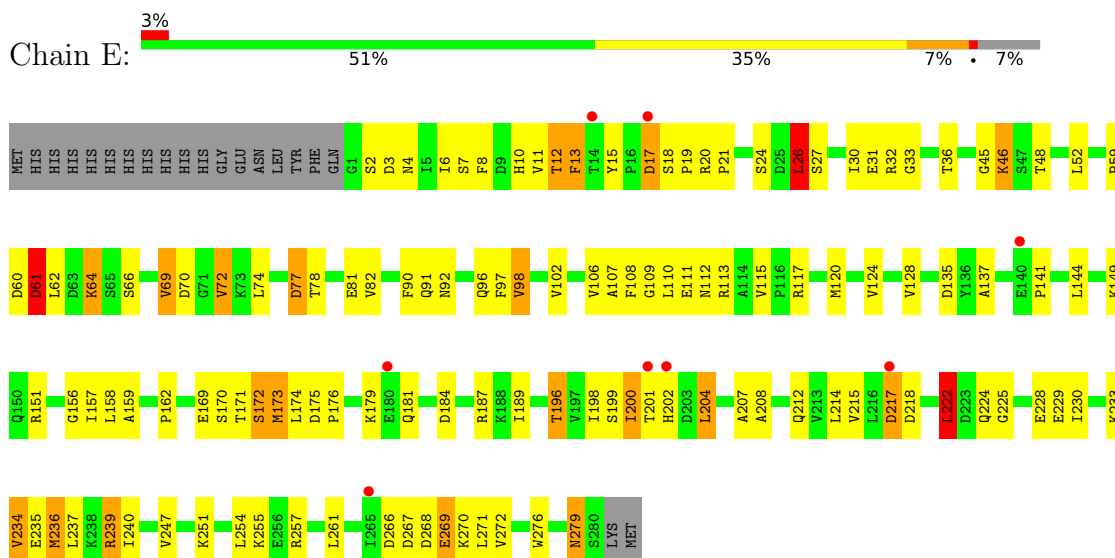

- Molecule 2: Energy-coupling factor transporter ATP-binding protein EcfA2



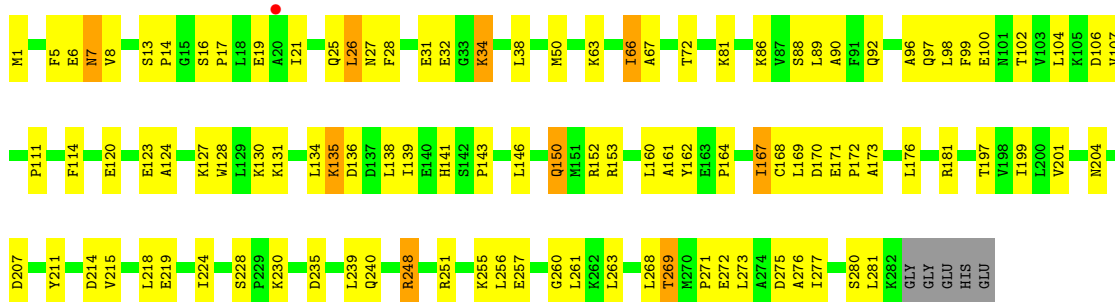

• Molecule 2: Energy-coupling factor transporter ATP-binding protein EcfA2

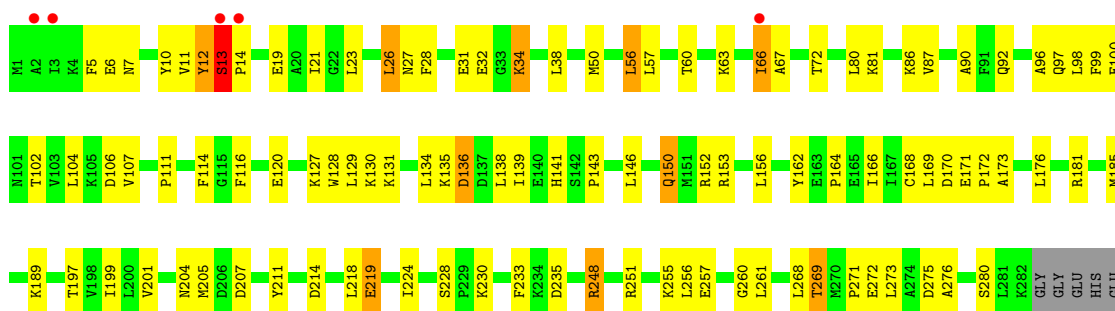

• Molecule 3: Conserved hypothetical membrane protein

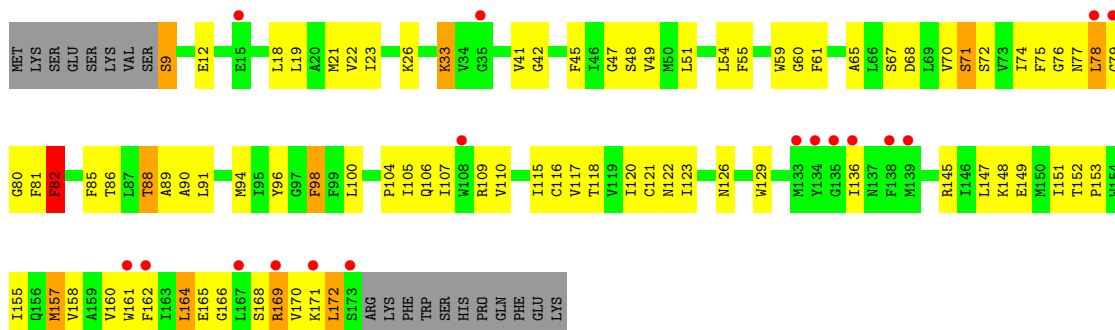

• Molecule 3: Conserved hypothetical membrane protein

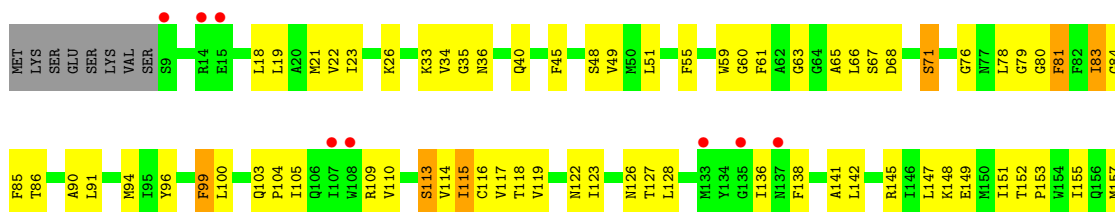

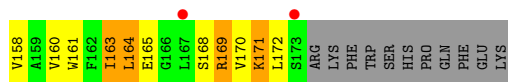

● Molecule 4: Energy-coupling factor transporter transmembrane protein EcfT

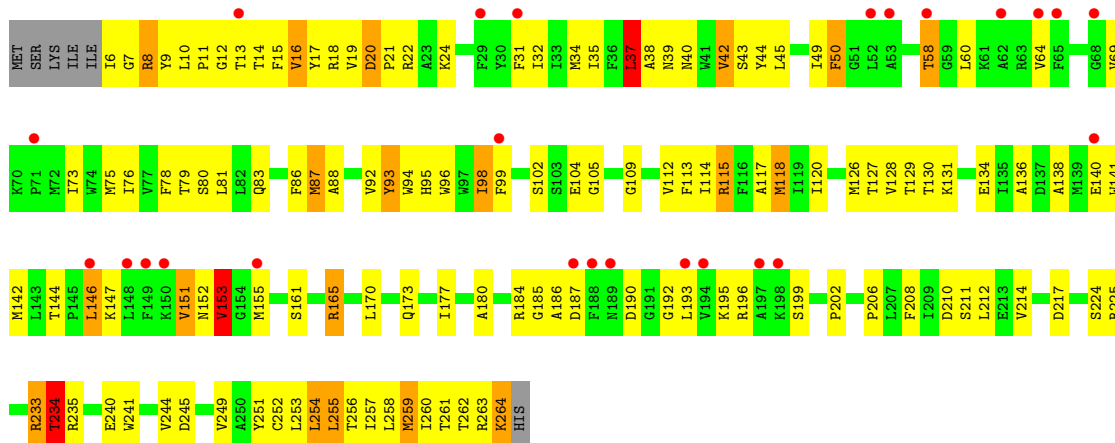

● Molecule 4: Energy-coupling factor transporter transmembrane protein EcfT

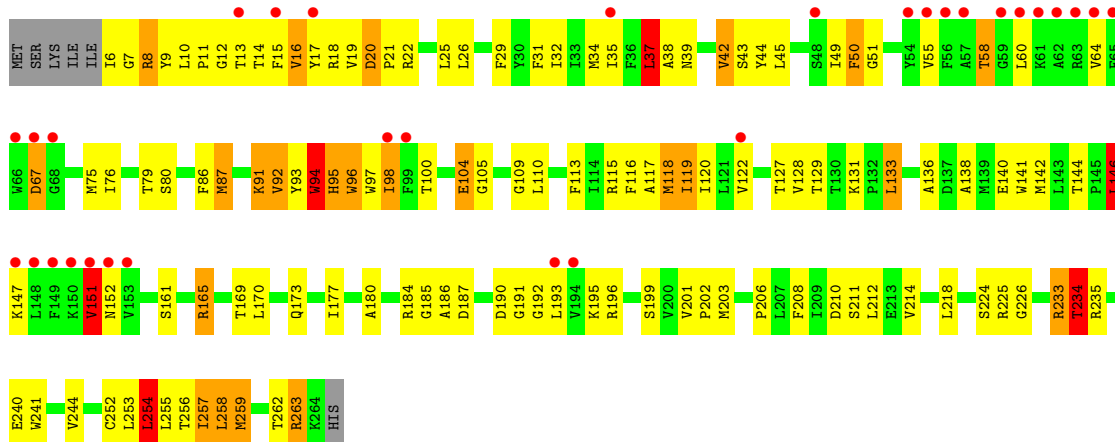

4 Data and refinement statistics i

Property	Value	Source
Space group	P 1	Depositor
Cell constants a, b, c, α , β , γ	88.82Å 95.32Å 107.57Å 83.45° 65.75° 61.99°	Depositor
Resolution (Å)	49.00 – 3.00 49.01 – 3.00	Depositor EDS
% Data completeness (in resolution range)	73.8 (49.00-3.00) 73.2 (49.01-3.00)	Depositor EDS
R_{merge}	0.04	Depositor
R_{sym}	(Not available)	Depositor
$\langle I/\sigma(I) \rangle$ ¹	1.65 (at 3.01Å)	Xtrriage
Refinement program	PHENIX (1.10_2155: ???)	Depositor
R, R_{free}	0.233 , 0.277 0.234 , 0.280	Depositor DCC
R_{free} test set	2088 reflections (5.03%)	wwPDB-VP
Wilson B-factor (Å ²)	89.9	Xtrriage
Anisotropy	0.015	Xtrriage
Bulk solvent k_{sol} (e/Å ³), B_{sol} (Å ²)	0.27 , 49.4	EDS
L-test for twinning ²	$\langle L \rangle = 0.45$, $\langle L^2 \rangle = 0.27$	Xtrriage
Estimated twinning fraction	0.327 for h,h-k,h-l	Xtrriage
F_o, F_c correlation	0.90	EDS
Total number of atoms	15394	wwPDB-VP
Average B, all atoms (Å ²)	102.0	wwPDB-VP

Xtrriage's analysis on translational NCS is as follows: *The largest off-origin peak in the Patterson function is 7.42% of the height of the origin peak. No significant pseudotranslation is detected.*

¹Intensities estimated from amplitudes.

²Theoretical values of $\langle |L| \rangle$, $\langle L^2 \rangle$ for acentric reflections are 0.5, 0.333 respectively for untwinned datasets, and 0.375, 0.2 for perfectly twinned datasets.

5 Model quality i

5.1 Standard geometry i

The Z score for a bond length (or angle) is the number of standard deviations the observed value is removed from the expected value. A bond length (or angle) with $|Z| > 5$ is considered an outlier worth inspection. RMSZ is the root-mean-square of all Z scores of the bond lengths (or angles).

Mol	Chain	Bond lengths		Bond angles	
		RMSZ	# Z >5	RMSZ	# Z >5
1	A	0.28	0/2180	0.52	0/2959
1	E	0.28	0/2180	0.58	2/2959 (0.1%)
2	B	0.27	0/2237	0.48	0/3019
2	F	0.26	0/2237	0.48	1/3019 (0.0%)
3	C	0.28	0/1307	0.55	0/1773
3	G	0.29	0/1307	0.58	0/1773
4	D	0.34	0/2136	0.60	1/2901 (0.0%)
4	H	0.37	0/2136	0.65	4/2901 (0.1%)
All	All	0.30	0/15720	0.56	8/21304 (0.0%)

Chiral center outliers are detected by calculating the chiral volume of a chiral center and verifying if the center is modelled as a planar moiety or with the opposite hand. A planarity outlier is detected by checking planarity of atoms in a peptide group, atoms in a mainchain group or atoms of a sidechain that are expected to be planar.

Mol	Chain	#Chirality outliers	#Planarity outliers
1	A	0	3
1	E	0	3
2	B	0	1
2	F	0	1
3	C	0	1
4	D	0	1
4	H	0	3
All	All	0	13

There are no bond length outliers.

All (8) bond angle outliers are listed below:

Mol	Chain	Res	Type	Atoms	Z	Observed(°)	Ideal(°)
1	E	26	LEU	CA-CB-CG	6.32	129.83	115.30
4	H	254	LEU	CB-CG-CD1	-6.10	100.63	111.00
4	H	146	LEU	CA-CB-CG	5.71	128.42	115.30

Continued on next page...

Continued from previous page...

Mol	Chain	Res	Type	Atoms	Z	Observed(°)	Ideal(°)
2	F	12	TYR	C-N-CA	5.56	135.60	121.70
1	E	222	LEU	CA-CB-CG	5.53	128.03	115.30
4	H	37	LEU	CA-CB-CG	5.29	127.46	115.30
4	H	94	TRP	N-CA-C	5.24	125.14	111.00
4	D	37	LEU	CA-CB-CG	5.11	127.04	115.30

There are no chirality outliers.

All (13) planarity outliers are listed below:

Mol	Chain	Res	Type	Group
1	A	12	THR	Peptide
1	A	18	SER	Peptide
1	A	69	VAL	Peptide
2	B	7	ASN	Peptide
3	C	82	PHE	Peptide
4	D	58	THR	Peptide
1	E	18	SER	Peptide
1	E	200	ILE	Peptide
1	E	69	VAL	Peptide
2	F	13	SER	Peptide
4	H	58	THR	Peptide
4	H	94	TRP	Peptide
4	H	96	TRP	Peptide

5.2 Too-close contacts [i](#)

In the following table, the Non-H and H(model) columns list the number of non-hydrogen atoms and hydrogen atoms in the chain respectively. The H(added) column lists the number of hydrogen atoms added and optimized by MolProbity. The Clashes column lists the number of clashes within the asymmetric unit, whereas Symm-Clashes lists symmetry-related clashes.

Mol	Chain	Non-H	H(model)	H(added)	Clashes	Symm-Clashes
1	A	2147	0	2159	84	0
1	E	2147	0	2159	83	0
2	B	2191	0	2199	60	0
2	F	2191	0	2199	61	0
3	C	1276	0	1349	68	0
3	G	1276	0	1349	60	0
4	D	2083	0	2185	117	0
4	H	2083	0	2185	111	0
All	All	15394	0	15784	593	0

The all-atom clashscore is defined as the number of clashes found per 1000 atoms (including hydrogen atoms). The all-atom clashscore for this structure is 19.

All (593) close contacts within the same asymmetric unit are listed below, sorted by their clash magnitude.

Atom-1	Atom-2	Interatomic distance (Å)	Clash overlap (Å)
4:H:94:TRP:HB2	4:H:95:HIS:CG	2.09	0.87
4:D:94:TRP:HB3	4:D:95:HIS:HB2	1.58	0.86
3:C:118:THR:HA	3:C:122:ASN:HB3	1.58	0.83
3:G:61:PHE:HB2	3:G:94:MET:HB2	1.61	0.81
4:D:22:ARG:NH2	4:D:240:GLU:O	2.14	0.81
4:H:42:VAL:HA	4:H:45:LEU:HB2	1.68	0.76
4:D:38:ALA:HB1	4:D:43:SER:HB3	1.66	0.76
3:C:72:SER:HA	3:C:77:ASN:HB2	1.68	0.76
1:E:36:THR:HG23	1:E:212:GLN:HB3	1.69	0.75
3:C:123:ILE:HG12	3:C:149:GLU:HG3	1.67	0.75
3:G:36:ASN:ND2	4:H:190:ASP:O	2.19	0.75
4:H:34:MET:HE1	4:H:256:THR:HA	1.68	0.75
4:D:95:HIS:H	4:D:98:ILE:HG12	1.50	0.75
3:G:118:THR:HG21	3:G:153:PRO:HB3	1.69	0.74
3:C:118:THR:HG21	3:C:153:PRO:HB3	1.70	0.74
4:D:253:LEU:O	4:D:256:THR:OG1	2.05	0.74
2:F:173:ALA:HB1	2:F:181:ARG:HG2	1.70	0.73
1:A:36:THR:HG23	1:A:212:GLN:HB3	1.71	0.73
4:D:20:ASP:OD1	4:D:22:ARG:NH2	2.22	0.73
3:C:26:LYS:NZ	3:C:48:SER:OG	2.20	0.73
3:C:171:LYS:HG3	4:D:208:PHE:HE2	1.51	0.73
3:C:33:LYS:HB3	3:C:42:GLY:HA2	1.71	0.73
4:D:13:THR:N	4:D:14:THR:HA	2.04	0.72
4:D:12:GLY:C	4:D:14:THR:HA	2.10	0.72
4:D:9:TYR:HB2	4:D:128:VAL:HA	1.70	0.72
3:C:80:GLY:HA2	3:C:81:PHE:HB2	1.72	0.72
1:E:77:ASP:OD1	1:E:77:ASP:N	2.22	0.72
4:H:50:PHE:CZ	4:H:254:LEU:HD11	2.24	0.71
1:A:7:SER:HB3	1:A:66:SER:H	1.54	0.71
4:H:12:GLY:C	4:H:14:THR:HA	2.11	0.71
4:H:13:THR:N	4:H:14:THR:HA	2.06	0.71
2:F:146:LEU:HB3	2:F:150:GLN:HG3	1.72	0.70
2:F:269:THR:HG22	2:F:272:GLU:H	1.56	0.70
2:B:146:LEU:HB3	2:B:150:GLN:HG3	1.72	0.70
4:D:60:LEU:HD11	4:D:128:VAL:HG11	1.73	0.70
1:E:91:GLN:HB2	1:E:169:GLU:HB3	1.72	0.70
4:H:50:PHE:HD2	4:H:255:LEU:HD23	1.55	0.70

Continued on next page...

Continued from previous page...

Atom-1	Atom-2	Interatomic distance (Å)	Clash overlap (Å)
2:B:19:GLU:HB3	2:B:21:ILE:HG22	1.73	0.69
3:C:61:PHE:HB2	3:C:94:MET:HB2	1.74	0.69
4:H:22:ARG:NH2	4:H:240:GLU:O	2.26	0.68
4:H:190:ASP:O	4:H:196:ARG:HG3	1.93	0.68
4:D:8:ARG:HG3	4:D:9:TYR:HA	1.75	0.67
1:A:21:PRO:HB2	1:A:24:SER:HB3	1.76	0.67
4:D:18:ARG:HH21	4:D:129:THR:HA	1.59	0.67
2:B:173:ALA:HB1	2:B:181:ARG:HG2	1.77	0.67
2:F:12:TYR:H	2:F:21:ILE:HD11	1.60	0.67
4:H:20:ASP:OD1	4:H:22:ARG:NH2	2.27	0.67
1:E:233:LYS:HE3	1:E:236:MET:HB3	1.76	0.66
4:H:92:VAL:N	4:H:93:TYR:HB2	2.10	0.66
4:D:141:TRP:O	4:D:144:THR:OG1	2.14	0.66
1:A:176:PRO:HG2	2:B:204:ASN:HD22	1.61	0.66
3:C:118:THR:O	3:C:123:ILE:N	2.23	0.66
1:A:92:ASN:HA	1:A:173:MET:HE1	1.78	0.66
3:G:168:SER:OG	3:G:169:ARG:NH1	2.29	0.66
1:E:97:PHE:O	4:H:165:ARG:NH2	2.28	0.66
2:F:269:THR:HG23	2:F:271:PRO:HD2	1.78	0.65
1:A:213:VAL:HB	1:A:230:ILE:HD11	1.77	0.65
2:B:269:THR:HG23	2:B:271:PRO:HD2	1.78	0.65
1:A:247:VAL:HG13	1:A:271:LEU:HD12	1.79	0.65
4:H:34:MET:HG2	4:H:255:LEU:CD1	2.26	0.65
2:F:134:LEU:HD22	2:F:138:LEU:HD12	1.77	0.65
1:A:12:THR:O	1:A:14:THR:N	2.30	0.64
4:D:252:CYS:O	4:D:256:THR:HG23	1.97	0.64
1:A:12:THR:OG1	1:A:21:PRO:HA	1.97	0.64
4:H:141:TRP:O	4:H:144:THR:OG1	2.15	0.64
4:H:234:THR:HG22	4:H:235:ARG:H	1.60	0.64
2:B:160:LEU:HD21	2:B:167:ILE:HD12	1.79	0.64
4:H:92:VAL:HG23	4:H:98:ILE:HG21	1.80	0.64
1:E:171:THR:HB	1:E:179:LYS:HG2	1.78	0.64
3:G:51:LEU:HD12	3:G:60:GLY:HA2	1.79	0.64
2:B:67:ALA:HB1	2:B:86:LYS:HD2	1.80	0.64
3:G:80:GLY:O	3:G:86:THR:OG1	2.15	0.64
1:A:11:VAL:HG22	1:A:59:PRO:HA	1.80	0.64
1:E:247:VAL:HG13	1:E:271:LEU:HD12	1.79	0.63
4:D:254:LEU:O	4:D:257:ILE:HG13	1.99	0.63
1:A:91:GLN:HB3	1:A:169:GLU:HB3	1.81	0.63
1:E:74:LEU:HD21	1:E:82:VAL:HG11	1.80	0.62
4:D:32:ILE:HA	4:D:35:ILE:HD12	1.81	0.62

Continued on next page...

Continued from previous page...

Atom-1	Atom-2	Interatomic distance (Å)	Clash overlap (Å)
4:H:253:LEU:O	4:H:256:THR:OG1	2.16	0.62
3:C:151:ILE:HG13	3:C:152:THR:HG23	1.80	0.62
4:H:91:LYS:HB2	4:H:93:TYR:CD1	2.34	0.62
4:H:60:LEU:HD11	4:H:128:VAL:HG11	1.81	0.62
4:H:257:ILE:HD12	4:H:258:LEU:HD23	1.81	0.61
4:D:234:THR:HG22	4:D:235:ARG:H	1.64	0.61
2:B:167:ILE:HD11	2:B:169:LEU:HD21	1.81	0.61
4:D:34:MET:HG2	4:D:255:LEU:HD11	1.83	0.61
2:B:134:LEU:HD22	2:B:138:LEU:HD12	1.82	0.61
3:C:65:ALA:HB2	3:C:90:ALA:HB2	1.83	0.61
2:F:214:ASP:HA	2:F:228:SER:HA	1.82	0.61
3:C:171:LYS:HG3	4:D:208:PHE:CE2	2.35	0.61
1:E:276:TRP:O	1:E:279:ASN:ND2	2.33	0.60
2:B:170:ASP:HA	2:B:201:VAL:HB	1.83	0.60
3:C:105:ILE:HD13	3:C:169:ARG:HD3	1.83	0.60
2:F:32:GLU:O	2:F:197:THR:OG1	2.17	0.60
1:A:115:VAL:HG13	1:E:115:VAL:HG13	1.82	0.60
2:B:269:THR:HG22	2:B:272:GLU:H	1.66	0.60
1:E:157:ILE:HG22	1:E:162:PRO:HG3	1.82	0.60
1:E:267:ASP:HB2	1:E:270:LYS:HD3	1.84	0.60
1:E:107:ALA:HB2	1:E:124:VAL:HG21	1.83	0.60
2:B:90:ALA:HB3	2:B:169:LEU:HD23	1.82	0.60
4:H:8:ARG:HG3	4:H:9:TYR:HA	1.82	0.60
2:B:98:LEU:HD23	2:B:143:PRO:HB2	1.83	0.60
4:D:12:GLY:H	4:D:18:ARG:NE	1.99	0.60
4:D:43:SER:N	4:D:262:THR:OG1	2.34	0.59
1:E:169:GLU:O	1:E:172:SER:HB2	2.01	0.59
2:F:67:ALA:HB1	2:F:86:LYS:HD2	1.84	0.59
1:E:267:ASP:HB3	1:E:269:GLU:HG3	1.84	0.59
1:A:97:PHE:O	4:D:165:ARG:NH2	2.35	0.59
1:A:157:ILE:HG22	1:A:162:PRO:HG3	1.84	0.59
2:B:66:ILE:HG23	2:B:67:ALA:H	1.67	0.59
3:G:26:LYS:NZ	3:G:48:SER:OG	2.32	0.59
4:D:19:VAL:HG21	4:D:244:VAL:HB	1.84	0.59
1:A:74:LEU:HD21	1:A:82:VAL:HG11	1.85	0.58
3:C:21:MET:HE2	4:D:170:LEU:HD11	1.85	0.58
4:H:94:TRP:CE3	4:H:95:HIS:HB2	2.38	0.58
3:C:147:LEU:HD23	3:C:148:LYS:HD3	1.85	0.58
4:H:50:PHE:CD2	4:H:255:LEU:HD23	2.37	0.58
4:H:32:ILE:HA	4:H:35:ILE:HD12	1.86	0.58
4:H:76:ILE:HG12	4:H:116:PHE:CD2	2.38	0.58

Continued on next page...

Continued from previous page...

Atom-1	Atom-2	Interatomic distance (Å)	Clash overlap (Å)
2:F:66:ILE:HG23	2:F:67:ALA:H	1.68	0.58
4:H:18:ARG:HH21	4:H:129:THR:HA	1.68	0.58
1:A:33:GLY:O	1:A:190:LYS:NZ	2.34	0.58
3:G:99:PHE:O	3:G:109:ARG:HD3	2.04	0.57
3:G:151:ILE:HG13	3:G:152:THR:HG23	1.85	0.57
1:E:176:PRO:HG2	2:F:204:ASN:HD22	1.69	0.57
3:G:110:VAL:HG11	3:G:161:TRP:HB2	1.86	0.57
3:G:123:ILE:HG12	3:G:149:GLU:HG3	1.85	0.57
1:A:2:SER:HA	1:A:31:GLU:HA	1.85	0.57
1:A:202:HIS:O	1:A:202:HIS:ND1	2.37	0.57
1:E:217:ASP:O	1:E:222:LEU:HD23	2.05	0.57
4:D:259:MET:HA	4:D:262:THR:HG22	1.87	0.57
4:H:12:GLY:H	4:H:18:ARG:NE	2.02	0.57
1:A:107:ALA:HB2	1:A:124:VAL:HG21	1.85	0.57
3:C:116:CYS:SG	3:C:117:VAL:N	2.77	0.57
3:C:110:VAL:HG11	3:C:161:TRP:HB2	1.87	0.57
4:H:94:TRP:HB2	4:H:95:HIS:CB	2.35	0.57
2:F:11:VAL:HG22	2:F:60:THR:HG21	1.86	0.57
4:D:43:SER:HA	4:D:262:THR:HG21	1.86	0.56
4:H:19:VAL:HG21	4:H:244:VAL:HB	1.86	0.56
2:B:32:GLU:O	2:B:197:THR:OG1	2.18	0.56
3:G:116:CYS:SG	3:G:117:VAL:N	2.78	0.56
3:C:45:PHE:O	3:C:49:VAL:HG23	2.05	0.56
4:D:95:HIS:N	4:D:98:ILE:HG12	2.19	0.56
1:E:215:VAL:HG21	1:E:230:ILE:HG21	1.86	0.56
2:F:98:LEU:HD23	2:F:143:PRO:HB2	1.87	0.56
3:G:36:ASN:HD22	4:H:191:GLY:HA2	1.71	0.56
1:E:26:LEU:HA	1:E:27:SER:OG	2.06	0.56
2:F:150:GLN:HA	2:F:153:ARG:HG3	1.88	0.56
3:C:82:PHE:HB2	3:C:85:PHE:CD2	2.41	0.56
4:H:34:MET:HG2	4:H:255:LEU:HD11	1.87	0.56
2:B:97:GLN:HG2	4:D:180:ALA:HB1	1.88	0.56
2:B:214:ASP:HA	2:B:228:SER:HA	1.87	0.56
3:C:104:PRO:HG2	3:C:109:ARG:HE	1.69	0.56
4:D:86:PHE:HE2	4:D:102:SER:HB2	1.71	0.56
4:H:252:CYS:O	4:H:256:THR:HG23	2.06	0.55
3:C:91:LEU:HD23	3:C:121:CYS:HB3	1.86	0.55
3:G:155:ILE:HD12	4:H:193:LEU:HD22	1.86	0.55
1:A:90:PHE:HB2	1:A:96:GLN:CD	2.27	0.55
2:B:50:MET:HG3	2:B:168:CYS:SG	2.47	0.55
4:D:34:MET:HE1	4:D:256:THR:HA	1.88	0.55

Continued on next page...

Continued from previous page...

Atom-1	Atom-2	Interatomic distance (Å)	Clash overlap (Å)
2:F:166:ILE:HG23	2:F:197:THR:HB	1.88	0.55
1:A:10:HIS:HA	1:A:24:SER:HA	1.87	0.55
3:C:67:SER:O	3:C:71:SER:HB2	2.07	0.55
2:F:12:TYR:CD2	2:F:21:ILE:HG13	2.42	0.55
3:G:171:LYS:HG2	4:H:208:PHE:CE2	2.40	0.55
3:C:75:PHE:HA	4:D:7:GLY:HA2	1.89	0.55
3:C:76:GLY:HA3	4:D:127:THR:HG21	1.89	0.55
1:E:12:THR:HG22	1:E:17:ASP:HB2	1.89	0.55
4:H:147:LYS:O	4:H:151:VAL:HG22	2.07	0.55
3:G:78:LEU:HB3	3:G:79:GLY:CA	2.37	0.55
4:H:87:MET:HE1	4:H:98:ILE:O	2.07	0.55
4:H:141:TRP:HE3	4:H:142:MET:HG2	1.71	0.55
3:C:164:LEU:O	3:C:168:SER:N	2.36	0.54
4:D:15:PHE:HB3	4:D:18:ARG:NH1	2.22	0.54
4:D:21:PRO:HG3	4:D:134:GLU:HB3	1.88	0.54
2:F:26:LEU:HD23	2:F:28:PHE:HE2	1.72	0.54
2:B:104:LEU:HB2	2:B:139:ILE:HG23	1.88	0.54
4:H:117:ALA:O	4:H:120:ILE:HG12	2.08	0.54
1:E:3:ASP:HB2	1:E:32:ARG:HB2	1.89	0.54
1:E:158:LEU:HD11	1:E:189:ILE:HG21	1.89	0.54
3:G:122:ASN:O	3:G:126:ASN:HB2	2.06	0.54
4:D:117:ALA:O	4:D:120:ILE:HG12	2.07	0.54
2:F:170:ASP:HA	2:F:201:VAL:HB	1.90	0.54
2:F:219:GLU:HB2	2:F:224:ILE:HD13	1.89	0.54
4:H:16:VAL:HG13	4:H:17:TYR:CD2	2.42	0.54
1:A:268:ASP:OD1	2:B:248:ARG:NH2	2.40	0.54
3:G:45:PHE:O	3:G:49:VAL:HG23	2.08	0.54
4:H:94:TRP:HE3	4:H:95:HIS:HB2	1.71	0.54
4:D:88:ALA:HB1	4:D:92:VAL:HB	1.89	0.54
1:A:108:PHE:CD2	4:D:225:ARG:HD3	2.42	0.54
4:D:258:LEU:O	4:D:261:THR:HG22	2.07	0.54
4:H:31:PHE:HE2	4:H:118:MET:HG3	1.73	0.54
1:A:61:ASP:CG	1:A:64:LYS:HG2	2.28	0.54
1:A:117:ARG:HA	1:A:120:MET:HE2	1.89	0.54
3:C:78:LEU:HD13	3:C:79:GLY:H	1.72	0.54
4:D:210:ASP:O	4:D:214:VAL:HG23	2.08	0.54
4:H:8:ARG:HB3	4:H:9:TYR:CD2	2.43	0.54
1:A:26:LEU:HD11	1:A:216:LEU:HD22	1.90	0.53
4:D:257:ILE:O	4:D:260:ILE:HG22	2.08	0.53
2:B:26:LEU:HD23	2:B:28:PHE:HE2	1.72	0.53
4:H:75:MET:O	4:H:79:THR:HG23	2.07	0.53

Continued on next page...

Continued from previous page...

Atom-1	Atom-2	Interatomic distance (Å)	Clash overlap (Å)
2:F:106:ASP:O	4:H:184:ARG:NH1	2.41	0.53
2:F:256:LEU:HD13	2:F:261:LEU:HD23	1.90	0.53
4:H:15:PHE:HB3	4:H:18:ARG:NH1	2.23	0.53
3:G:147:LEU:HD23	3:G:148:LYS:HD3	1.90	0.53
4:H:50:PHE:HZ	4:H:254:LEU:HD11	1.71	0.53
1:A:202:HIS:HB3	1:A:206:GLU:CD	2.29	0.53
2:F:230:LYS:HA	2:F:268:LEU:HD11	1.89	0.53
1:A:251:LYS:HG2	1:A:261:LEU:HD12	1.90	0.53
2:B:207:ASP:HB2	2:B:211:TYR:HD2	1.74	0.53
4:D:39:ASN:OD1	4:D:40:ASN:ND2	2.37	0.53
1:E:225:GLY:CA	1:E:230:ILE:HD11	2.39	0.53
1:E:251:LYS:HG2	1:E:261:LEU:HD12	1.91	0.53
4:H:21:PRO:HB2	4:H:138:ALA:HB2	1.90	0.53
2:F:152:ARG:NH1	2:F:172:PRO:O	2.42	0.53
1:A:45:GLY:O	1:A:48:THR:HG22	2.09	0.53
1:A:237:LEU:HA	1:A:240:ILE:HD12	1.90	0.53
4:H:67:ASP:N	4:H:67:ASP:OD1	2.41	0.52
3:C:18:LEU:HA	3:C:21:MET:HB2	1.90	0.52
1:E:222:LEU:HD11	1:E:240:ILE:HD11	1.89	0.52
3:G:35:GLY:HA2	3:G:40:GLN:O	2.10	0.52
3:C:168:SER:O	3:C:172:LEU:HB2	2.10	0.52
3:C:105:ILE:O	3:C:105:ILE:HG13	2.10	0.52
3:C:160:VAL:O	3:C:164:LEU:HB3	2.09	0.52
2:F:63:LYS:HG3	2:F:72:THR:HG22	1.90	0.52
4:D:8:ARG:HB3	4:D:9:TYR:CD2	2.45	0.52
1:E:257:ARG:NE	2:F:275:ASP:OD1	2.37	0.52
3:C:155:ILE:HD12	4:D:193:LEU:HD22	1.90	0.52
1:E:214:LEU:HG	1:E:224:GLN:HG3	1.92	0.52
1:E:21:PRO:HB2	1:E:24:SER:HB2	1.92	0.51
1:A:91:GLN:HB3	1:A:169:GLU:CB	2.40	0.51
4:D:39:ASN:ND2	4:D:263:ARG:O	2.44	0.51
3:G:171:LYS:HG2	4:H:208:PHE:HE2	1.75	0.51
4:D:263:ARG:HD2	4:D:264:LYS:HZ3	1.74	0.51
1:E:61:ASP:HB2	1:E:64:LYS:HE3	1.92	0.51
1:A:267:ASP:HB2	1:A:270:LYS:HD2	1.92	0.51
1:A:92:ASN:H	1:A:96:GLN:HE22	1.59	0.51
1:A:234:VAL:O	1:A:238:LYS:N	2.36	0.51
1:E:92:ASN:H	1:E:96:GLN:HE22	1.59	0.51
2:F:31:GLU:HG2	2:F:32:GLU:H	1.74	0.51
2:B:106:ASP:O	4:D:184:ARG:NH1	2.43	0.51
4:H:94:TRP:HE3	4:H:95:HIS:N	2.08	0.51

Continued on next page...

Continued from previous page...

Atom-1	Atom-2	Interatomic distance (Å)	Clash overlap (Å)
1:E:90:PHE:HB2	1:E:96:GLN:CD	2.31	0.51
1:A:158:LEU:HD11	1:A:189:ILE:HG21	1.92	0.51
1:E:91:GLN:HB2	1:E:169:GLU:CB	2.39	0.51
1:A:106:VAL:HG21	1:A:128:VAL:HG12	1.93	0.51
3:C:166:GLY:O	3:C:170:VAL:N	2.38	0.51
4:H:210:ASP:O	4:H:214:VAL:HG23	2.11	0.51
4:D:105:GLY:O	4:D:109:GLY:N	2.35	0.51
2:B:13:SER:HB3	2:B:14:PRO:HD2	1.91	0.50
4:D:16:VAL:HG13	4:D:17:TYR:CD2	2.47	0.50
4:D:42:VAL:HG22	4:D:262:THR:HB	1.94	0.50
2:F:90:ALA:HB3	2:F:169:LEU:HD23	1.93	0.50
2:F:104:LEU:HB2	2:F:139:ILE:HG23	1.93	0.50
4:H:141:TRP:CE3	4:H:142:MET:HG2	2.46	0.50
4:D:144:THR:O	4:D:147:LYS:HG3	2.11	0.50
4:D:94:TRP:HB3	4:D:95:HIS:CB	2.35	0.50
4:D:126:MET:O	4:D:130:THR:OG1	2.28	0.50
1:E:60:ASP:O	1:E:61:ASP:HB3	2.12	0.50
1:E:266:ASP:H	1:E:270:LYS:HE2	1.76	0.50
3:C:9:SER:O	3:C:12:GLU:HG3	2.10	0.50
4:H:86:PHE:CZ	4:H:104:GLU:HB3	2.45	0.50
1:A:110:LEU:HD11	1:A:159:ALA:HB1	1.94	0.50
1:E:13:PHE:O	1:E:17:ASP:HB3	2.12	0.50
1:E:102:VAL:HB	1:E:137:ALA:O	2.12	0.50
2:B:63:LYS:HG3	2:B:72:THR:HG22	1.93	0.50
2:B:256:LEU:HD12	2:B:263:LEU:HD11	1.94	0.50
3:G:169:ARG:HD2	3:G:169:ARG:N	2.27	0.50
4:H:11:PRO:HG2	4:H:131:LYS:HG3	1.94	0.50
1:A:237:LEU:O	1:A:240:ILE:HB	2.12	0.49
4:D:177:ILE:HD13	4:D:206:PRO:HB2	1.94	0.49
1:E:45:GLY:O	1:E:48:THR:HG22	2.10	0.49
1:A:102:VAL:HB	1:A:137:ALA:O	2.12	0.49
1:E:117:ARG:HA	1:E:120:MET:HE2	1.94	0.49
2:B:256:LEU:HD13	2:B:261:LEU:HD23	1.94	0.49
4:D:141:TRP:HE3	4:D:142:MET:HG2	1.78	0.49
1:E:108:PHE:CD2	4:H:225:ARG:HD3	2.47	0.49
1:E:169:GLU:N	1:E:169:GLU:OE1	2.45	0.49
3:G:23:ILE:HD13	3:G:51:LEU:HD21	1.95	0.49
3:C:19:LEU:O	3:C:23:ILE:HG12	2.12	0.49
2:B:99:PHE:CZ	2:B:100:GLU:HG2	2.47	0.49
3:C:26:LYS:HB2	3:C:47:GLY:HA3	1.94	0.49
4:D:6:ILE:HB	4:D:7:GLY:O	2.13	0.49

Continued on next page...

Continued from previous page...

Atom-1	Atom-2	Interatomic distance (Å)	Clash overlap (Å)
2:B:230:LYS:HA	2:B:268:LEU:HD11	1.94	0.49
3:C:121:CYS:SG	3:C:122:ASN:N	2.86	0.49
3:G:63:GLY:HA2	3:G:66:LEU:HD12	1.94	0.49
2:B:168:CYS:HA	2:B:199:ILE:HB	1.95	0.49
4:D:192:GLY:HA3	4:D:195:LYS:HG3	1.94	0.49
1:E:27:SER:OG	1:E:27:SER:O	2.29	0.49
4:H:10:LEU:H	4:H:10:LEU:HD23	1.78	0.49
2:B:256:LEU:O	2:B:260:GLY:N	2.46	0.48
4:D:15:PHE:HB3	4:D:18:ARG:HH12	1.78	0.48
3:G:136:ILE:HD11	4:H:79:THR:HG22	1.93	0.48
1:A:27:SER:O	1:A:27:SER:OG	2.31	0.48
4:D:11:PRO:HG2	4:D:131:LYS:HG3	1.95	0.48
2:F:5:PHE:O	2:F:27:ASN:HA	2.13	0.48
4:H:9:TYR:HB2	4:H:128:VAL:HA	1.95	0.48
2:B:31:GLU:HG2	2:B:32:GLU:H	1.77	0.48
2:B:107:VAL:O	2:B:111:PRO:HD2	2.13	0.48
4:D:93:TYR:N	4:D:93:TYR:CD1	2.81	0.48
1:E:33:GLY:H	1:E:196:THR:HB	1.78	0.48
4:H:6:ILE:HB	4:H:7:GLY:O	2.14	0.48
4:H:136:ALA:O	4:H:140:GLU:HG2	2.14	0.48
1:A:92:ASN:O	1:A:96:GLN:NE2	2.46	0.48
1:A:7:SER:OG	1:A:8:PHE:N	2.46	0.48
3:C:136:ILE:HD11	4:D:79:THR:HG22	1.95	0.48
4:D:39:ASN:OD1	4:D:263:ARG:HA	2.14	0.48
1:E:204:LEU:O	1:E:208:ALA:N	2.44	0.48
2:F:256:LEU:O	2:F:260:GLY:N	2.46	0.48
3:G:19:LEU:O	3:G:23:ILE:HG12	2.14	0.48
3:G:138:PHE:O	3:G:142:LEU:HB2	2.14	0.48
4:H:31:PHE:CE2	4:H:118:MET:HG3	2.49	0.48
3:G:18:LEU:HA	3:G:21:MET:HB2	1.96	0.48
2:B:135:LYS:H	2:B:135:LYS:NZ	2.12	0.48
3:G:114:VAL:HG11	3:G:157:MET:HG3	1.96	0.48
3:C:105:ILE:HG21	3:C:169:ARG:HD3	1.96	0.48
1:A:21:PRO:CB	1:A:24:SER:HB3	2.43	0.47
3:C:51:LEU:HD12	3:C:60:GLY:HA2	1.96	0.47
4:D:190:ASP:O	4:D:196:ARG:HG3	2.13	0.47
1:E:11:VAL:HG21	1:E:52:LEU:HD11	1.96	0.47
3:G:78:LEU:HB3	3:G:79:GLY:HA3	1.95	0.47
3:C:151:ILE:HG13	3:C:152:THR:H	1.79	0.47
1:E:2:SER:HA	1:E:31:GLU:HA	1.95	0.47
2:B:219:GLU:HB2	2:B:224:ILE:HD13	1.97	0.47

Continued on next page...

Continued from previous page...

Atom-1	Atom-2	Interatomic distance (Å)	Clash overlap (Å)
3:C:77:ASN:HB3	3:C:78:LEU:C	2.35	0.47
4:D:141:TRP:CE3	4:D:142:MET:HG2	2.49	0.47
3:C:115:ILE:O	3:C:118:THR:OG1	2.24	0.47
3:G:105:ILE:HG13	3:G:105:ILE:O	2.14	0.47
2:F:207:ASP:HB2	2:F:211:TYR:HD2	1.80	0.47
3:G:18:LEU:O	3:G:22:VAL:HG23	2.15	0.47
4:H:140:GLU:O	4:H:144:THR:HG23	2.14	0.47
1:A:23:LEU:HD22	1:A:26:LEU:HD22	1.97	0.47
2:B:150:GLN:HA	2:B:153:ARG:HG3	1.96	0.47
4:D:34:MET:CE	4:D:256:THR:HA	2.44	0.47
4:D:146:LEU:HD13	4:D:151:VAL:CG1	2.43	0.47
3:G:163:ILE:HD11	4:H:201:VAL:HG22	1.96	0.47
4:H:105:GLY:O	4:H:109:GLY:N	2.28	0.47
4:H:185:GLY:HA3	4:H:186:ALA:HB2	1.96	0.47
1:A:73:LYS:O	1:A:78:THR:HG21	2.14	0.47
3:C:23:ILE:HD13	3:C:51:LEU:HD21	1.96	0.47
4:D:31:PHE:CE2	4:D:118:MET:HG3	2.50	0.47
1:E:200:ILE:O	1:E:201:THR:HG22	2.14	0.47
2:F:23:LEU:HB3	2:F:26:LEU:HD13	1.97	0.47
1:A:111:GLU:O	4:D:233:ARG:HB2	2.15	0.47
2:B:38:LEU:HD11	2:B:218:LEU:HD11	1.97	0.47
4:D:76:ILE:HA	4:D:79:THR:HG23	1.97	0.47
1:E:110:LEU:HD11	1:E:159:ALA:HB1	1.96	0.47
1:E:156:GLY:HA3	4:H:225:ARG:HH22	1.80	0.47
1:E:255:LYS:NZ	1:E:261:LEU:H	2.13	0.47
3:G:65:ALA:HB2	3:G:90:ALA:HB2	1.96	0.47
4:H:38:ALA:HB2	4:H:259:MET:HE1	1.97	0.47
2:B:251:ARG:O	2:B:255:LYS:HB2	2.15	0.47
4:D:31:PHE:HE2	4:D:118:MET:HG3	1.79	0.47
4:D:185:GLY:HA3	4:D:186:ALA:HB2	1.97	0.47
1:E:11:VAL:HG22	1:E:59:PRO:HA	1.97	0.47
4:H:43:SER:N	4:H:262:THR:HG21	2.30	0.47
1:A:217:ASP:O	1:A:222:LEU:HD13	2.14	0.46
1:A:255:LYS:NZ	1:A:261:LEU:H	2.13	0.46
1:A:265:ILE:HG23	1:A:270:LYS:HB2	1.97	0.46
3:C:110:VAL:HB	3:C:161:TRP:HD1	1.80	0.46
4:H:192:GLY:HA3	4:H:195:LYS:HB2	1.97	0.46
4:H:254:LEU:O	4:H:257:ILE:HG13	2.14	0.46
2:B:120:GLU:HA	2:B:123:GLU:HB2	1.97	0.46
2:B:124:ALA:HB1	2:B:161:ALA:O	2.16	0.46
4:D:136:ALA:O	4:D:140:GLU:HG2	2.15	0.46

Continued on next page...

Continued from previous page...

Atom-1	Atom-2	Interatomic distance (Å)	Clash overlap (Å)
1:E:173:MET:H	1:E:173:MET:HG2	1.58	0.46
1:E:215:VAL:HB	1:E:222:LEU:O	2.16	0.46
2:F:129:LEU:HD13	2:F:139:ILE:HG13	1.97	0.46
4:H:15:PHE:HB3	4:H:18:ARG:HH12	1.80	0.46
3:C:51:LEU:O	3:C:55:PHE:HB2	2.16	0.46
3:C:88:THR:HG23	3:C:129:TRP:HE1	1.81	0.46
4:D:251:TYR:O	4:D:255:LEU:HD23	2.16	0.46
2:F:162:TYR:CE1	2:F:164:PRO:HG3	2.51	0.46
4:H:199:SER:O	4:H:202:PRO:HD2	2.16	0.46
2:B:276:ALA:O	2:B:280:SER:HB3	2.16	0.46
1:E:111:GLU:O	4:H:233:ARG:HB2	2.15	0.46
1:E:204:LEU:O	1:E:207:ALA:N	2.46	0.46
2:F:50:MET:HG3	2:F:168:CYS:SG	2.56	0.46
4:D:24:LYS:HG2	4:D:126:MET:SD	2.56	0.46
3:G:109:ARG:O	3:G:113:SER:OG	2.31	0.46
3:C:151:ILE:HG13	3:C:152:THR:N	2.30	0.46
4:D:87:MET:HG3	4:D:99:PHE:HA	1.96	0.46
4:D:199:SER:O	4:D:202:PRO:HD2	2.16	0.46
1:E:46:LYS:HE3	1:E:201:THR:HB	1.98	0.46
1:E:61:ASP:OD2	1:E:64:LYS:HG2	2.16	0.46
1:A:3:ASP:HB2	1:A:32:ARG:HA	1.98	0.46
4:D:40:ASN:H	4:D:43:SER:HB2	1.81	0.46
2:F:92:GLN:HG3	2:F:171:GLU:HB3	1.98	0.46
4:H:31:PHE:HB3	4:H:122:VAL:HG21	1.97	0.46
4:H:60:LEU:HD13	4:H:64:VAL:HG21	1.98	0.46
4:D:75:MET:O	4:D:79:THR:HG23	2.16	0.46
2:F:276:ALA:O	2:F:280:SER:HB3	2.15	0.46
4:D:152:ASN:HD21	4:D:155:MET:HG2	1.81	0.45
4:H:51:GLY:O	4:H:55:VAL:HG23	2.15	0.45
1:A:26:LEU:HA	1:A:26:LEU:HD12	1.49	0.45
4:D:254:LEU:O	4:D:258:LEU:HD12	2.16	0.45
1:E:237:LEU:O	1:E:240:ILE:HB	2.17	0.45
4:D:8:ARG:CG	4:D:9:TYR:HA	2.44	0.45
4:D:44:TYR:HD1	4:D:114:ILE:HG13	1.81	0.45
2:F:31:GLU:HB3	2:F:34:LYS:HD3	1.98	0.45
3:G:161:TRP:O	3:G:165:GLU:HG2	2.17	0.45
1:A:92:ASN:N	1:A:96:GLN:HE22	2.15	0.45
2:F:96:ALA:O	4:H:206:PRO:HB3	2.16	0.45
1:A:272:VAL:HG22	2:B:256:LEU:HD23	1.98	0.45
3:C:18:LEU:O	3:C:22:VAL:HG23	2.16	0.45
1:E:30:ILE:HG13	1:E:198:ILE:HD12	1.99	0.45

Continued on next page...

Continued from previous page...

Atom-1	Atom-2	Interatomic distance (Å)	Clash overlap (Å)
1:E:69:VAL:O	1:E:72:VAL:HG23	2.17	0.45
3:G:68:ASP:HB3	3:G:80:GLY:HA3	1.99	0.45
1:A:68:THR:HG22	1:A:73:LYS:HD3	1.99	0.45
1:A:217:ASP:HA	1:A:218:ASP:HA	1.56	0.45
3:G:151:ILE:HG13	3:G:152:THR:N	2.31	0.45
4:D:21:PRO:HB2	4:D:138:ALA:HB2	1.99	0.45
1:E:30:ILE:HG21	1:E:198:ILE:CD1	2.47	0.45
1:E:90:PHE:HB2	1:E:96:GLN:OE1	2.17	0.45
1:A:61:ASP:O	1:A:62:LEU:HB2	2.17	0.45
3:C:96:TYR:O	3:C:100:LEU:HB2	2.17	0.45
1:E:108:PHE:HD2	4:H:225:ARG:HD3	1.82	0.45
2:F:107:VAL:O	2:F:111:PRO:HD2	2.17	0.45
4:H:144:THR:O	4:H:146:LEU:N	2.50	0.45
4:H:39:ASN:OD1	4:H:263:ARG:HA	2.17	0.44
1:A:156:GLY:HA3	4:D:225:ARG:HH22	1.82	0.44
2:B:162:TYR:CE2	2:B:164:PRO:HG3	2.53	0.44
3:G:100:LEU:HA	3:G:100:LEU:HD23	1.82	0.44
1:A:108:PHE:HD2	4:D:225:ARG:HD3	1.81	0.44
3:C:169:ARG:HE	3:C:169:ARG:HB2	1.59	0.44
4:D:93:TYR:N	4:D:93:TYR:HD1	2.15	0.44
4:D:259:MET:HA	4:D:262:THR:CG2	2.46	0.44
1:E:12:THR:CG2	1:E:17:ASP:HB2	2.46	0.44
4:H:45:LEU:O	4:H:49:ILE:HG13	2.17	0.44
4:H:151:VAL:HB	4:H:152:ASN:H	1.53	0.44
2:B:88:SER:OG	2:B:162:TYR:OH	2.30	0.44
1:E:17:ASP:C	1:E:19:PRO:HD2	2.37	0.44
3:G:76:GLY:HA2	4:H:127:THR:HG21	1.99	0.44
3:C:70:VAL:O	3:C:74:ILE:HG13	2.17	0.44
4:D:37:LEU:C	4:D:259:MET:HE1	2.37	0.44
4:D:44:TYR:HE1	4:D:115:ARG:HB2	1.83	0.44
1:E:106:VAL:HG21	1:E:128:VAL:HG12	2.00	0.44
1:E:228:GLU:CD	1:E:228:GLU:H	2.21	0.44
2:F:97:GLN:HG2	4:H:180:ALA:HB1	1.98	0.44
2:F:189:LYS:HD3	2:F:189:LYS:HA	1.87	0.44
3:G:170:VAL:HG12	3:G:171:LYS:HD2	1.99	0.44
4:D:15:PHE:HE1	4:D:58:THR:O	2.00	0.44
2:F:251:ARG:O	2:F:255:LYS:HB2	2.18	0.44
1:E:109:GLY:O	1:E:113:ARG:HG2	2.18	0.44
2:F:56:LEU:HD12	2:F:56:LEU:HA	1.89	0.44
4:H:15:PHE:HE1	4:H:58:THR:O	1.99	0.44
1:E:92:ASN:O	1:E:96:GLN:NE2	2.51	0.44

Continued on next page...

Continued from previous page...

Atom-1	Atom-2	Interatomic distance (Å)	Clash overlap (Å)
3:G:67:SER:O	3:G:71:SER:HB2	2.18	0.44
1:A:267:ASP:HB3	1:A:269:GLU:HG3	2.00	0.44
4:D:196:ARG:HD3	4:D:199:SER:OG	2.17	0.44
1:E:78:THR:HG22	1:E:82:VAL:HG23	2.00	0.44
4:H:94:TRP:CE3	4:H:95:HIS:N	2.85	0.44
1:A:200:ILE:O	1:A:201:THR:HG22	2.18	0.43
2:F:38:LEU:HD11	2:F:218:LEU:HD11	2.00	0.43
4:D:60:LEU:HD13	4:D:64:VAL:HG21	1.99	0.43
3:C:21:MET:HG3	4:D:211:SER:HB2	2.00	0.43
3:C:82:PHE:HB2	3:C:85:PHE:CE2	2.53	0.43
4:H:42:VAL:HG13	4:H:262:THR:HG23	1.99	0.43
1:A:46:LYS:HB3	1:A:216:LEU:HD12	1.99	0.43
2:B:152:ARG:NH1	2:B:172:PRO:O	2.51	0.43
2:B:277:ILE:O	2:B:281:LEU:HG	2.18	0.43
3:C:94:MET:O	3:C:98:PHE:N	2.48	0.43
1:E:115:VAL:O	4:H:234:THR:HG21	2.18	0.43
3:G:151:ILE:HG13	3:G:152:THR:H	1.83	0.43
4:H:50:PHE:HD1	4:H:50:PHE:HA	1.70	0.43
4:H:87:MET:HE2	4:H:100:THR:HG22	1.99	0.43
1:A:97:PHE:CD2	1:A:141:PRO:HB3	2.53	0.43
3:C:105:ILE:HB	3:C:165:GLU:OE2	2.19	0.43
4:H:147:LYS:HB2	4:H:147:LYS:NZ	2.33	0.43
1:A:215:VAL:HB	1:A:222:LEU:O	2.19	0.43
3:C:96:TYR:CE1	3:C:117:VAL:HG21	2.54	0.43
3:C:106:GLN:C	3:C:161:TRP:HE1	2.21	0.43
1:E:239:ARG:O	1:E:239:ARG:NE	2.50	0.43
2:F:173:ALA:HA	2:F:176:LEU:HD12	1.99	0.43
3:G:81:PHE:CZ	4:H:25:LEU:HD11	2.54	0.43
3:C:76:GLY:CA	4:D:127:THR:HG21	2.48	0.43
3:C:100:LEU:HD23	3:C:100:LEU:HA	1.72	0.43
4:D:264:LYS:HE2	4:D:264:LYS:HB2	1.85	0.43
3:G:85:PHE:N	3:G:85:PHE:CD1	2.85	0.43
4:H:195:LYS:HB3	4:H:196:ARG:CZ	2.49	0.43
1:A:133:MET:HE1	1:A:144:LEU:HD22	2.00	0.43
4:D:152:ASN:O	4:D:153:VAL:HG22	2.19	0.43
3:G:115:ILE:O	3:G:118:THR:OG1	2.30	0.43
1:A:31:GLU:HG3	1:A:34:SER:HB3	2.01	0.43
1:A:56:LEU:HD11	4:D:224:SER:OG	2.18	0.42
1:A:106:VAL:HA	1:A:156:GLY:HA2	2.00	0.42
2:B:127:LYS:O	2:B:131:LYS:HB2	2.18	0.42
3:C:157:MET:H	3:C:157:MET:HG3	1.68	0.42

Continued on next page...

Continued from previous page...

Atom-1	Atom-2	Interatomic distance (Å)	Clash overlap (Å)
4:D:42:VAL:HG22	4:D:262:THR:CB	2.48	0.42
2:F:207:ASP:HB2	2:F:211:TYR:CD2	2.54	0.42
4:H:173:GLN:HE21	4:H:177:ILE:HD11	1.84	0.42
1:A:95:ASN:HB3	4:D:217:ASP:HB2	2.00	0.42
2:B:173:ALA:HA	2:B:176:LEU:HD12	2.01	0.42
4:D:173:GLN:HE21	4:D:177:ILE:HD11	1.85	0.42
2:F:116:PHE:CD2	2:F:120:GLU:HG3	2.55	0.42
3:G:51:LEU:O	3:G:55:PHE:HB2	2.18	0.42
1:A:257:ARG:NE	2:B:275:ASP:OD1	2.46	0.42
4:D:252:CYS:HA	4:D:255:LEU:HD23	2.01	0.42
1:E:254:LEU:HD23	1:E:254:LEU:HA	1.89	0.42
1:E:268:ASP:OD1	2:F:248:ARG:NH2	2.51	0.42
2:F:13:SER:HB3	2:F:14:PRO:HD3	2.00	0.42
2:F:99:PHE:CZ	2:F:100:GLU:HG2	2.54	0.42
4:H:263:ARG:O	4:H:263:ARG:HG3	2.17	0.42
3:C:68:ASP:OD1	3:C:89:ALA:HB3	2.20	0.42
4:D:37:LEU:HD23	4:D:259:MET:SD	2.59	0.42
3:G:136:ILE:H	3:G:136:ILE:HD12	1.85	0.42
4:H:35:ILE:HD13	4:H:119:ILE:HG22	2.01	0.42
2:B:207:ASP:HB2	2:B:211:TYR:CD2	2.54	0.42
4:D:69:VAL:O	4:D:73:ILE:HG13	2.19	0.42
1:E:234:VAL:HG23	1:E:235:GLU:H	1.84	0.42
3:G:118:THR:O	3:G:122:ASN:HB2	2.19	0.42
4:H:6:ILE:HA	4:H:7:GLY:HA3	1.82	0.42
2:B:92:GLN:HG3	2:B:171:GLU:HB3	2.02	0.42
4:D:45:LEU:O	4:D:49:ILE:HG13	2.19	0.42
4:H:196:ARG:HD3	4:H:199:SER:OG	2.20	0.42
1:A:95:ASN:ND2	4:D:217:ASP:OD2	2.51	0.42
2:B:269:THR:O	2:B:273:LEU:N	2.51	0.42
1:E:97:PHE:CD2	1:E:141:PRO:HB3	2.54	0.42
1:A:157:ILE:O	1:A:162:PRO:HD3	2.20	0.42
1:E:272:VAL:HG13	2:F:256:LEU:HD23	2.01	0.42
3:G:49:VAL:HG22	3:G:96:TYR:CE2	2.55	0.42
3:G:152:THR:N	3:G:153:PRO:HD2	2.35	0.42
4:H:79:THR:OG1	4:H:80:SER:N	2.53	0.42
1:A:233:LYS:HE3	1:A:236:MET:HB3	2.00	0.42
4:D:161:SER:O	4:D:165:ARG:HB2	2.20	0.42
3:G:34:VAL:HA	3:G:35:GLY:HA3	1.59	0.42
4:H:144:THR:O	4:H:147:LYS:HG3	2.19	0.42
1:A:26:LEU:HB3	1:A:27:SER:H	1.65	0.42
1:A:234:VAL:HG23	1:A:235:GLU:H	1.84	0.42

Continued on next page...

Continued from previous page...

Atom-1	Atom-2	Interatomic distance (Å)	Clash overlap (Å)
2:B:5:PHE:O	2:B:27:ASN:HA	2.20	0.42
2:B:16:SER:HB2	2:B:17:PRO:HD2	2.02	0.42
1:E:144:LEU:O	1:E:149:LYS:NZ	2.47	0.42
3:G:21:MET:HG3	4:H:211:SER:HB2	2.01	0.42
1:A:228:GLU:CD	1:A:228:GLU:H	2.23	0.41
2:F:156:LEU:HD23	2:F:156:LEU:HA	1.91	0.41
1:A:207:ALA:HB1	1:A:231:PHE:HZ	1.85	0.41
4:D:78:PHE:HA	4:D:81:LEU:HB2	2.01	0.41
2:F:269:THR:O	2:F:273:LEU:N	2.51	0.41
4:D:140:GLU:O	4:D:144:THR:HG23	2.20	0.41
1:E:11:VAL:HG21	1:E:52:LEU:CD1	2.49	0.41
2:F:127:LYS:O	2:F:131:LYS:HB2	2.19	0.41
2:B:128:TRP:CD1	2:B:161:ALA:HA	2.55	0.41
4:D:43:SER:HA	4:D:262:THR:CG2	2.48	0.41
4:D:83:GLN:OE1	4:D:112:VAL:HG21	2.20	0.41
3:G:171:LYS:HD2	3:G:171:LYS:N	2.35	0.41
4:H:42:VAL:HG22	4:H:262:THR:HG21	2.02	0.41
1:A:109:GLY:O	1:A:113:ARG:HG2	2.21	0.41
2:F:168:CYS:HA	2:F:199:ILE:HB	2.02	0.41
4:H:76:ILE:HG12	4:H:116:PHE:CG	2.55	0.41
1:A:240:ILE:HG22	1:A:242:LEU:HG	2.03	0.41
3:C:122:ASN:O	3:C:126:ASN:HB2	2.20	0.41
1:A:201:THR:HG23	1:A:201:THR:O	2.19	0.41
4:D:147:LYS:NZ	4:D:147:LYS:HB2	2.35	0.41
1:E:112:ASN:HB3	4:H:226:GLY:O	2.21	0.41
3:G:103:GLN:HB3	3:G:104:PRO:HD2	2.02	0.41
2:B:8:VAL:N	2:B:25:GLN:O	2.54	0.41
1:E:7:SER:OG	1:E:66:SER:N	2.30	0.41
1:E:98:VAL:HG23	4:H:218:LEU:HD11	2.02	0.41
1:E:217:ASP:HA	1:E:218:ASP:HA	1.55	0.41
4:H:133:LEU:H	4:H:133:LEU:HD23	1.85	0.41
2:B:96:ALA:O	4:D:206:PRO:HB3	2.21	0.41
4:D:50:PHE:HD1	4:D:50:PHE:HA	1.74	0.41
4:D:245:ASP:O	4:D:249:VAL:HG23	2.21	0.41
1:E:151:ARG:HH22	1:E:181:GLN:NE2	2.18	0.41
3:G:83:ILE:HG22	3:G:84:GLY:H	1.85	0.41
3:G:119:VAL:O	3:G:123:ILE:HB	2.21	0.41
3:G:160:VAL:O	3:G:164:LEU:HB3	2.20	0.41
4:H:44:TYR:HE1	4:H:115:ARG:HB2	1.85	0.41
1:A:30:ILE:HD12	1:A:36:THR:HG21	2.03	0.41
3:C:152:THR:N	3:C:153:PRO:HD2	2.36	0.41

Continued on next page...

Continued from previous page...

Atom-1	Atom-2	Interatomic distance (Å)	Clash overlap (Å)
2:F:128:TRP:HA	2:F:131:LYS:HB2	2.03	0.41
4:H:29:PHE:O	4:H:32:ILE:HG13	2.21	0.41
1:A:26:LEU:HG	1:A:28:PHE:HD2	1.86	0.40
1:A:115:VAL:O	4:D:234:THR:HG21	2.20	0.40
2:B:50:MET:O	2:B:89:LEU:HD21	2.22	0.40
3:C:136:ILE:HD12	3:C:136:ILE:H	1.87	0.40
2:F:10:TYR:CZ	2:F:57:LEU:HD13	2.57	0.40
2:F:87:VAL:HG22	2:F:166:ILE:HD12	2.03	0.40
3:C:77:ASN:HB3	3:C:78:LEU:HB3	2.02	0.40
2:F:136:ASP:HA	2:F:139:ILE:HD13	2.02	0.40
1:A:246:PHE:O	1:A:250:LEU:N	2.46	0.40
1:A:254:LEU:HD23	1:A:254:LEU:HA	1.91	0.40
2:B:150:GLN:HE21	2:B:150:GLN:HB3	1.59	0.40
4:H:37:LEU:HD23	4:H:259:MET:SD	2.61	0.40
3:C:149:GLU:O	3:C:153:PRO:HG3	2.22	0.40
4:D:79:THR:OG1	4:D:80:SER:N	2.54	0.40
2:F:205:MET:HG3	2:F:233:PHE:CZ	2.57	0.40
3:G:99:PHE:N	3:G:99:PHE:CD1	2.87	0.40
3:G:127:THR:HG23	3:G:141:ALA:HB3	2.03	0.40
4:H:91:LYS:HB2	4:H:91:LYS:HE2	1.95	0.40
2:B:31:GLU:HB3	2:B:34:LYS:HD3	2.02	0.40
3:C:105:ILE:HB	3:C:165:GLU:CD	2.42	0.40
4:D:233:ARG:O	4:D:233:ARG:HD3	2.21	0.40

There are no symmetry-related clashes.

5.3 Torsion angles [i](#)

5.3.1 Protein backbone [i](#)

In the following table, the Percentiles column shows the percent Ramachandran outliers of the chain as a percentile score with respect to all X-ray entries followed by that with respect to entries of similar resolution.

The Analysed column shows the number of residues for which the backbone conformation was analysed, and the total number of residues.

Mol	Chain	Analysed	Favoured	Allowed	Outliers	Percentiles
1	A	278/300 (93%)	250 (90%)	25 (9%)	3 (1%)	14 50
1	E	278/300 (93%)	254 (91%)	22 (8%)	2 (1%)	22 60

Continued on next page...

Continued from previous page...

Mol	Chain	Analysed	Favoured	Allowed	Outliers	Percentiles	
2	B	280/287 (98%)	264 (94%)	16 (6%)	0	100	100
2	F	280/287 (98%)	263 (94%)	16 (6%)	1 (0%)	34	72
3	C	163/184 (89%)	143 (88%)	18 (11%)	2 (1%)	13	48
3	G	163/184 (89%)	147 (90%)	15 (9%)	1 (1%)	25	64
4	D	257/265 (97%)	244 (95%)	11 (4%)	2 (1%)	19	57
4	H	257/265 (97%)	241 (94%)	13 (5%)	3 (1%)	13	48
All	All	1956/2072 (94%)	1806 (92%)	136 (7%)	14 (1%)	22	60

All (14) Ramachandran outliers are listed below:

Mol	Chain	Res	Type
1	A	13	PHE
4	D	153	VAL
4	D	234	THR
2	F	13	SER
4	H	234	THR
1	E	61	ASP
1	A	17	ASP
3	G	83	ILE
1	A	234	VAL
1	E	234	VAL
4	H	151	VAL
4	H	92	VAL
3	C	120	ILE
3	C	41	VAL

5.3.2 Protein sidechains [i](#)

In the following table, the Percentiles column shows the percent sidechain outliers of the chain as a percentile score with respect to all X-ray entries followed by that with respect to entries of similar resolution.

The Analysed column shows the number of residues for which the sidechain conformation was analysed, and the total number of residues.

Mol	Chain	Analysed	Rotameric	Outliers	Percentiles	
1	A	240/259 (93%)	220 (92%)	20 (8%)	11	39
1	E	240/259 (93%)	202 (84%)	38 (16%)	2	12
2	B	231/234 (99%)	209 (90%)	22 (10%)	8	32

Continued on next page...

Continued from previous page...

Mol	Chain	Analysed	Rotameric	Outliers	Percentiles	
2	F	231/234 (99%)	209 (90%)	22 (10%)	8	32
3	C	136/155 (88%)	118 (87%)	18 (13%)	4	18
3	G	136/155 (88%)	120 (88%)	16 (12%)	5	22
4	D	227/233 (97%)	199 (88%)	28 (12%)	4	21
4	H	227/233 (97%)	189 (83%)	38 (17%)	2	11
All	All	1668/1762 (95%)	1466 (88%)	202 (12%)	5	21

All (202) residues with a non-rotameric sidechain are listed below:

Mol	Chain	Res	Type
1	A	8	PHE
1	A	10	HIS
1	A	20	ARG
1	A	64	LYS
1	A	70	ASP
1	A	78	THR
1	A	135	ASP
1	A	170	SER
1	A	184	ASP
1	A	187	ARG
1	A	201	THR
1	A	202	HIS
1	A	204	LEU
1	A	205	GLU
1	A	217	ASP
1	A	222	LEU
1	A	236	MET
1	A	255	LYS
1	A	269	GLU
1	A	279	ASN
2	B	1	MET
2	B	6	GLU
2	B	7	ASN
2	B	26	LEU
2	B	34	LYS
2	B	66	ILE
2	B	81	LYS
2	B	102	THR
2	B	114	PHE
2	B	130	LYS

Continued on next page...

Continued from previous page...

Mol	Chain	Res	Type
2	B	135	LYS
2	B	136	ASP
2	B	141	HIS
2	B	150	GLN
2	B	167	ILE
2	B	215	VAL
2	B	235	ASP
2	B	239	LEU
2	B	240	GLN
2	B	248	ARG
2	B	257	GLU
2	B	269	THR
3	C	9	SER
3	C	33	LYS
3	C	54	LEU
3	C	59	TRP
3	C	71	SER
3	C	78	LEU
3	C	82	PHE
3	C	86	THR
3	C	88	THR
3	C	98	PHE
3	C	107	ILE
3	C	145	ARG
3	C	157	MET
3	C	158	VAL
3	C	162	PHE
3	C	164	LEU
3	C	169	ARG
3	C	172	LEU
4	D	8	ARG
4	D	10	LEU
4	D	16	VAL
4	D	20	ASP
4	D	37	LEU
4	D	42	VAL
4	D	50	PHE
4	D	87	MET
4	D	93	TYR
4	D	96	TRP
4	D	98	ILE
4	D	104	GLU

Continued on next page...

Continued from previous page...

Mol	Chain	Res	Type
4	D	113	PHE
4	D	115	ARG
4	D	118	MET
4	D	146	LEU
4	D	151	VAL
4	D	153	VAL
4	D	165	ARG
4	D	187	ASP
4	D	212	LEU
4	D	233	ARG
4	D	234	THR
4	D	241	TRP
4	D	254	LEU
4	D	255	LEU
4	D	259	MET
4	D	264	LYS
1	E	4	ASN
1	E	6	ILE
1	E	8	PHE
1	E	10	HIS
1	E	12	THR
1	E	13	PHE
1	E	15	TYR
1	E	17	ASP
1	E	20	ARG
1	E	26	LEU
1	E	46	LYS
1	E	61	ASP
1	E	62	LEU
1	E	64	LYS
1	E	70	ASP
1	E	72	VAL
1	E	77	ASP
1	E	81	GLU
1	E	98	VAL
1	E	135	ASP
1	E	170	SER
1	E	172	SER
1	E	173	MET
1	E	174	LEU
1	E	175	ASP
1	E	184	ASP

Continued on next page...

Continued from previous page...

Mol	Chain	Res	Type
1	E	187	ARG
1	E	196	THR
1	E	199	SER
1	E	202	HIS
1	E	204	LEU
1	E	217	ASP
1	E	222	LEU
1	E	229	GLU
1	E	236	MET
1	E	239	ARG
1	E	269	GLU
1	E	279	ASN
2	F	6	GLU
2	F	7	ASN
2	F	19	GLU
2	F	26	LEU
2	F	34	LYS
2	F	56	LEU
2	F	66	ILE
2	F	80	LEU
2	F	81	LYS
2	F	102	THR
2	F	114	PHE
2	F	130	LYS
2	F	135	LYS
2	F	136	ASP
2	F	141	HIS
2	F	150	GLN
2	F	185	MET
2	F	219	GLU
2	F	235	ASP
2	F	248	ARG
2	F	257	GLU
2	F	269	THR
3	G	33	LYS
3	G	59	TRP
3	G	71	SER
3	G	81	PHE
3	G	91	LEU
3	G	99	PHE
3	G	113	SER
3	G	115	ILE

Continued on next page...

Continued from previous page...

Mol	Chain	Res	Type
3	G	128	LEU
3	G	145	ARG
3	G	158	VAL
3	G	163	ILE
3	G	164	LEU
3	G	169	ARG
3	G	171	LYS
3	G	172	LEU
4	H	8	ARG
4	H	16	VAL
4	H	20	ASP
4	H	26	LEU
4	H	37	LEU
4	H	42	VAL
4	H	50	PHE
4	H	67	ASP
4	H	87	MET
4	H	91	LYS
4	H	95	HIS
4	H	96	TRP
4	H	97	TRP
4	H	98	ILE
4	H	104	GLU
4	H	110	LEU
4	H	113	PHE
4	H	118	MET
4	H	119	ILE
4	H	133	LEU
4	H	146	LEU
4	H	151	VAL
4	H	161	SER
4	H	165	ARG
4	H	169	THR
4	H	170	LEU
4	H	187	ASP
4	H	203	MET
4	H	212	LEU
4	H	224	SER
4	H	233	ARG
4	H	234	THR
4	H	241	TRP
4	H	254	LEU

Continued on next page...

Continued from previous page...

Mol	Chain	Res	Type
4	H	257	ILE
4	H	258	LEU
4	H	259	MET
4	H	263	ARG

Sometimes sidechains can be flipped to improve hydrogen bonding and reduce clashes. All (3) such sidechains are listed below:

Mol	Chain	Res	Type
1	A	96	GLN
1	E	96	GLN
3	G	77	ASN

5.3.3 RNA [i](#)

There are no RNA molecules in this entry.

5.4 Non-standard residues in protein, DNA, RNA chains [i](#)

There are no non-standard protein/DNA/RNA residues in this entry.

5.5 Carbohydrates [i](#)

There are no monosaccharides in this entry.

5.6 Ligand geometry [i](#)

There are no ligands in this entry.

5.7 Other polymers [i](#)

There are no such residues in this entry.

5.8 Polymer linkage issues [i](#)

There are no chain breaks in this entry.

6 Fit of model and data

6.1 Protein, DNA and RNA chains

In the following table, the column labelled ‘#RSRZ > 2’ contains the number (and percentage) of RSRZ outliers, followed by percent RSRZ outliers for the chain as percentile scores relative to all X-ray entries and entries of similar resolution. The OWAB column contains the minimum, median, 95th percentile and maximum values of the occupancy-weighted average B-factor per residue. The column labelled ‘Q < 0.9’ lists the number of (and percentage) of residues with an average occupancy less than 0.9.

Mol	Chain	Analysed	<RSRZ>	#RSRZ>2	OWAB(Å ²)	Q<0.9
1	A	280/300 (93%)	-0.22	11 (3%) 39 15	41, 81, 147, 261	0
1	E	280/300 (93%)	-0.24	8 (2%) 51 23	40, 83, 154, 279	0
2	B	282/287 (98%)	-0.41	1 (0%) 92 79	44, 76, 134, 209	0
2	F	282/287 (98%)	-0.20	5 (1%) 68 40	39, 74, 147, 225	0
3	C	165/184 (89%)	0.19	17 (10%) 6 2	51, 121, 192, 247	0
3	G	165/184 (89%)	0.09	10 (6%) 21 7	59, 121, 198, 261	0
4	D	259/265 (97%)	0.20	25 (9%) 7 2	54, 110, 203, 255	0
4	H	259/265 (97%)	0.41	31 (11%) 4 1	45, 110, 225, 279	0
All	All	1972/2072 (95%)	-0.05	108 (5%) 25 9	39, 90, 186, 279	0

All (108) RSRZ outliers are listed below:

Mol	Chain	Res	Type	RSRZ
4	H	60	LEU	13.5
3	G	173	SER	11.2
4	H	13	THR	11.1
4	H	150	LYS	10.0
3	C	173	SER	9.9
4	H	148	LEU	9.5
4	D	148	LEU	8.3
4	H	151	VAL	8.2
4	H	59	GLY	8.1
4	H	149	PHE	7.8
1	E	14	THR	7.0
3	C	133	MET	6.2
4	H	61	LYS	6.1
4	H	57	ALA	5.7
1	A	202	HIS	5.4
4	H	67	ASP	5.4

Continued on next page...

Continued from previous page...

Mol	Chain	Res	Type	RSRZ
3	C	35	GLY	5.3
3	C	169	ARG	5.2
3	C	15	GLU	5.2
4	H	62	ALA	5.1
1	E	217	ASP	5.0
4	D	13	THR	4.9
1	E	17	ASP	4.9
3	G	15	GLU	4.8
2	F	14	PRO	4.6
4	H	15	PHE	4.3
1	E	180	GLU	4.2
4	D	193	LEU	4.2
4	D	65	PHE	4.0
3	G	14	ARG	4.0
4	H	68	GLY	4.0
3	C	78	LEU	3.9
4	D	68	GLY	3.9
4	D	31	PHE	3.8
3	G	107	ILE	3.8
3	C	134	TYR	3.7
4	H	65	PHE	3.7
3	G	108	TRP	3.6
4	H	66	TRP	3.6
1	A	205	GLU	3.6
3	C	138	PHE	3.5
1	A	15	TYR	3.5
4	H	48	SER	3.5
3	G	9	SER	3.5
3	G	137	ASN	3.4
4	D	150	LYS	3.4
4	D	188	PHE	3.3
4	H	56	PHE	3.3
4	H	193	LEU	3.3
2	F	2	ALA	3.2
3	C	135	GLY	3.1
3	C	167	LEU	3.1
3	G	167	LEU	3.1
3	C	79	GLY	3.1
2	F	13	SER	3.0
1	E	265	ILE	3.0
4	D	197	ALA	3.0
1	A	26	LEU	3.0

Continued on next page...

Continued from previous page...

Mol	Chain	Res	Type	RSRZ
3	C	108	TRP	2.9
3	G	133	MET	2.9
4	D	194	VAL	2.9
4	H	194	VAL	2.9
4	H	35	ILE	2.9
4	D	53	ALA	2.8
1	A	50	SER	2.8
4	D	189	ASN	2.8
4	H	147	LYS	2.8
1	E	202	HIS	2.8
4	H	122	VAL	2.8
1	A	203	ASP	2.8
4	D	198	LYS	2.7
4	H	63	ARG	2.7
4	H	64	VAL	2.7
4	H	54	TYR	2.7
4	H	17	TYR	2.7
4	H	152	ASN	2.6
4	D	71	PRO	2.6
4	D	62	ALA	2.6
1	A	263	ASP	2.6
3	C	171	LYS	2.6
4	H	55	VAL	2.6
3	G	135	GLY	2.6
2	F	3	ILE	2.6
3	C	161	TRP	2.5
4	H	98	ILE	2.5
2	F	66	ILE	2.5
1	E	201	THR	2.4
4	H	99	PHE	2.4
3	C	162	PHE	2.4
3	C	136	ILE	2.4
1	E	140	GLU	2.4
4	D	58	THR	2.3
1	A	206	GLU	2.3
4	D	64	VAL	2.3
4	D	155	MET	2.2
1	A	180	GLU	2.2
1	A	18	SER	2.2
4	D	29	PHE	2.2
4	D	149	PHE	2.1
4	D	187	ASP	2.1

Continued on next page...

Continued from previous page...

Mol	Chain	Res	Type	RSRZ
4	H	153	VAL	2.1
4	D	140	GLU	2.1
4	D	146	LEU	2.1
3	C	139	MET	2.1
1	A	178	GLY	2.1
4	D	52	LEU	2.0
2	B	20	ALA	2.0
4	D	99	PHE	2.0

6.2 Non-standard residues in protein, DNA, RNA chains [i](#)

There are no non-standard protein/DNA/RNA residues in this entry.

6.3 Carbohydrates [i](#)

There are no monosaccharides in this entry.

6.4 Ligands [i](#)

There are no ligands in this entry.

6.5 Other polymers [i](#)

There are no such residues in this entry.