



# Full wwPDB X-ray Structure Validation Report ⓘ

Sep 20, 2023 – 11:43 PM EDT

PDB ID : 5H8K  
Title : Crystal structure of *Medicago truncatula* N-carbamoylputrescine amidohydrolase (MtCPA) C158S mutant  
Authors : Sekula, B.; Ruzskowski, M.; Malinska, M.; Dauter, Z.  
Deposited on : 2015-12-23  
Resolution : 2.39 Å (reported)

This is a Full wwPDB X-ray Structure Validation Report for a publicly released PDB entry.

We welcome your comments at [validation@mail.wwpdb.org](mailto:validation@mail.wwpdb.org)

A user guide is available at

<https://www.wwpdb.org/validation/2017/XrayValidationReportHelp>

with specific help available everywhere you see the ⓘ symbol.

The types of validation reports are described at

<http://www.wwpdb.org/validation/2017/FAQs#types>.

---

The following versions of software and data (see [references ⓘ](#)) were used in the production of this report:

MolProbity : 4.02b-467  
Mogul : 1.8.5 (274361), CSD as541be (2020)  
Xtriage (Phenix) : 1.13  
EDS : 2.35.1  
Percentile statistics : 20191225.v01 (using entries in the PDB archive December 25th 2019)  
Refmac : 5.8.0158  
CCP4 : 7.0.044 (Gargrove)  
Ideal geometry (proteins) : Engh & Huber (2001)  
Ideal geometry (DNA, RNA) : Parkinson et al. (1996)  
Validation Pipeline (wwPDB-VP) : 2.35.1

# 1 Overall quality at a glance

The following experimental techniques were used to determine the structure:

*X-RAY DIFFRACTION*

The reported resolution of this entry is 2.39 Å.

Percentile scores (ranging between 0-100) for global validation metrics of the entry are shown in the following graphic. The table shows the number of entries on which the scores are based.

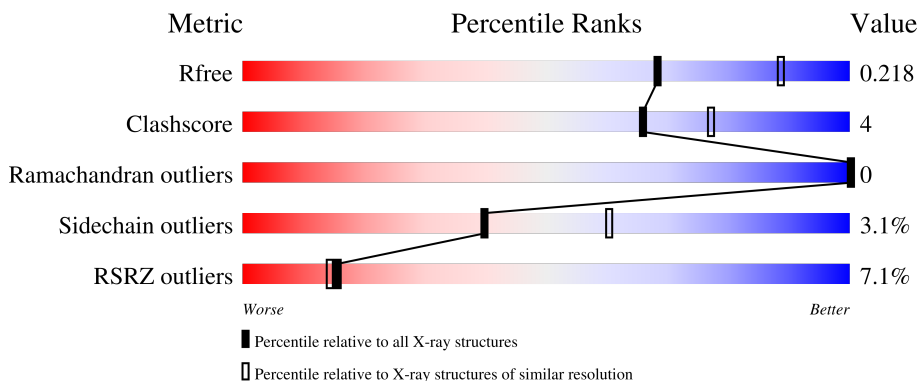

Metric	Whole archive (#Entries)	Similar resolution (#Entries, resolution range(Å))
$R_{free}$	130704	3907 (2.40-2.40)
Clashscore	141614	4398 (2.40-2.40)
Ramachandran outliers	138981	4318 (2.40-2.40)
Sidechain outliers	138945	4319 (2.40-2.40)
RSRZ outliers	127900	3811 (2.40-2.40)

The table below summarises the geometric issues observed across the polymeric chains and their fit to the electron density. The red, orange, yellow and green segments of the lower bar indicate the fraction of residues that contain outliers for  $\geq 3$ , 2, 1 and 0 types of geometric quality criteria respectively. A grey segment represents the fraction of residues that are not modelled. The numeric value for each fraction is indicated below the corresponding segment, with a dot representing fractions  $\leq 5\%$ . The upper red bar (where present) indicates the fraction of residues that have poor fit to the electron density. The numeric value is given above the bar.

Mol	Chain	Length	Quality of chain
1	A	304	 6% 85% 11% ..
1	B	304	 92% 6% .
1	C	304	 91% 8% ..
1	D	304	 90% 8% .
1	E	304	 3% 91% 6% .

Continued on next page...

Continued from previous page...

Mol	Chain	Length	Quality of chain
1	F	304	
1	G	304	
1	H	304	
1	I	304	
1	J	304	
1	K	304	
1	L	304	
1	M	304	
1	N	304	
1	O	304	
1	P	304	

The following table lists non-polymeric compounds, carbohydrate monomers and non-standard residues in protein, DNA, RNA chains that are outliers for geometric or electron-density-fit criteria:

Mol	Type	Chain	Res	Chirality	Geometry	Clashes	Electron density
2	GOL	B	405	-	-	-	X
2	GOL	E	404	-	-	-	X

## 2 Entry composition

There are 5 unique types of molecules in this entry. The entry contains 40889 atoms, of which 0 are hydrogens and 0 are deuteriums.

In the tables below, the ZeroOcc column contains the number of atoms modelled with zero occupancy, the AltConf column contains the number of residues with at least one atom in alternate conformation and the Trace column contains the number of residues modelled with at most 2 atoms.

- Molecule 1 is a protein called N-carbamoylputrescine amidohydrolase.

Mol	Chain	Residues	Atoms					ZeroOcc	AltConf	Trace
			Total	C	N	O	S			
1	A	294	Total 2333	C 1492	N 402	O 431	S 8	0	1	0
1	B	297	Total 2363	C 1509	N 408	O 439	S 7	0	1	0
1	C	301	Total 2390	C 1524	N 412	O 445	S 9	0	1	0
1	D	298	Total 2368	C 1511	N 409	O 440	S 8	0	1	0
1	E	297	Total 2357	C 1505	N 408	O 437	S 7	0	0	0
1	F	298	Total 2368	C 1511	N 409	O 440	S 8	0	1	0
1	G	295	Total 2344	C 1497	N 405	O 435	S 7	0	0	0
1	H	278	Total 2217	C 1423	N 383	O 403	S 8	0	1	0
1	I	293	Total 2327	C 1487	N 401	O 431	S 8	0	1	0
1	J	298	Total 2368	C 1511	N 409	O 440	S 8	0	1	0
1	K	301	Total 2396	C 1528	N 412	O 447	S 9	0	2	0
1	L	298	Total 2368	C 1511	N 409	O 440	S 8	0	1	0
1	M	297	Total 2360	C 1507	N 408	O 437	S 8	0	1	0
1	N	298	Total 2365	C 1509	N 409	O 440	S 7	0	0	0
1	O	297	Total 2357	C 1505	N 408	O 437	S 7	0	0	0
1	P	288	Total 2289	C 1465	N 394	O 423	S 7	0	0	0

There are 64 discrepancies between the modelled and reference sequences:

Chain	Residue	Modelled	Actual	Comment	Reference
A	-2	SER	-	expression tag	UNP G7ITU5
A	-1	ASN	-	expression tag	UNP G7ITU5
A	0	ALA	-	expression tag	UNP G7ITU5
A	158	SER	CYS	engineered mutation	UNP G7ITU5
B	-2	SER	-	expression tag	UNP G7ITU5
B	-1	ASN	-	expression tag	UNP G7ITU5
B	0	ALA	-	expression tag	UNP G7ITU5
B	158	SER	CYS	engineered mutation	UNP G7ITU5
C	-2	SER	-	expression tag	UNP G7ITU5
C	-1	ASN	-	expression tag	UNP G7ITU5
C	0	ALA	-	expression tag	UNP G7ITU5
C	158	SER	CYS	engineered mutation	UNP G7ITU5
D	-2	SER	-	expression tag	UNP G7ITU5
D	-1	ASN	-	expression tag	UNP G7ITU5
D	0	ALA	-	expression tag	UNP G7ITU5
D	158	SER	CYS	engineered mutation	UNP G7ITU5
E	-2	SER	-	expression tag	UNP G7ITU5
E	-1	ASN	-	expression tag	UNP G7ITU5
E	0	ALA	-	expression tag	UNP G7ITU5
E	158	SER	CYS	engineered mutation	UNP G7ITU5
F	-2	SER	-	expression tag	UNP G7ITU5
F	-1	ASN	-	expression tag	UNP G7ITU5
F	0	ALA	-	expression tag	UNP G7ITU5
F	158	SER	CYS	engineered mutation	UNP G7ITU5
G	-2	SER	-	expression tag	UNP G7ITU5
G	-1	ASN	-	expression tag	UNP G7ITU5
G	0	ALA	-	expression tag	UNP G7ITU5
G	158	SER	CYS	engineered mutation	UNP G7ITU5
H	-2	SER	-	expression tag	UNP G7ITU5
H	-1	ASN	-	expression tag	UNP G7ITU5
H	0	ALA	-	expression tag	UNP G7ITU5
H	158	SER	CYS	engineered mutation	UNP G7ITU5
I	-2	SER	-	expression tag	UNP G7ITU5
I	-1	ASN	-	expression tag	UNP G7ITU5
I	0	ALA	-	expression tag	UNP G7ITU5
I	158	SER	CYS	engineered mutation	UNP G7ITU5
J	-2	SER	-	expression tag	UNP G7ITU5
J	-1	ASN	-	expression tag	UNP G7ITU5
J	0	ALA	-	expression tag	UNP G7ITU5
J	158	SER	CYS	engineered mutation	UNP G7ITU5
K	-2	SER	-	expression tag	UNP G7ITU5
K	-1	ASN	-	expression tag	UNP G7ITU5

*Continued on next page...*

Continued from previous page...

Chain	Residue	Modelled	Actual	Comment	Reference
K	0	ALA	-	expression tag	UNP G7ITU5
K	158	SER	CYS	engineered mutation	UNP G7ITU5
L	-2	SER	-	expression tag	UNP G7ITU5
L	-1	ASN	-	expression tag	UNP G7ITU5
L	0	ALA	-	expression tag	UNP G7ITU5
L	158	SER	CYS	engineered mutation	UNP G7ITU5
M	-2	SER	-	expression tag	UNP G7ITU5
M	-1	ASN	-	expression tag	UNP G7ITU5
M	0	ALA	-	expression tag	UNP G7ITU5
M	158	SER	CYS	engineered mutation	UNP G7ITU5
N	-2	SER	-	expression tag	UNP G7ITU5
N	-1	ASN	-	expression tag	UNP G7ITU5
N	0	ALA	-	expression tag	UNP G7ITU5
N	158	SER	CYS	engineered mutation	UNP G7ITU5
O	-2	SER	-	expression tag	UNP G7ITU5
O	-1	ASN	-	expression tag	UNP G7ITU5
O	0	ALA	-	expression tag	UNP G7ITU5
O	158	SER	CYS	engineered mutation	UNP G7ITU5
P	-2	SER	-	expression tag	UNP G7ITU5
P	-1	ASN	-	expression tag	UNP G7ITU5
P	0	ALA	-	expression tag	UNP G7ITU5
P	158	SER	CYS	engineered mutation	UNP G7ITU5

- Molecule 2 is GLYCEROL (three-letter code: GOL) (formula:  $C_3H_8O_3$ ).

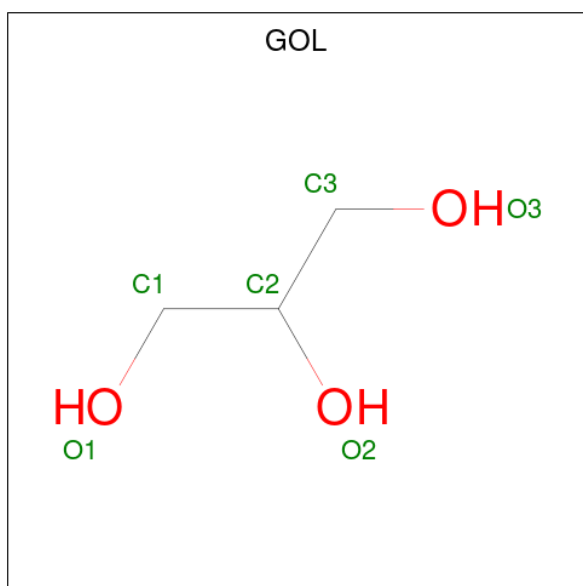

Mol	Chain	Residues	Atoms			ZeroOcc	AltConf
2	A	1	Total 6	C 3	O 3	0	0
2	A	1	Total 6	C 3	O 3	0	0
2	B	1	Total 6	C 3	O 3	0	0
2	B	1	Total 6	C 3	O 3	0	0
2	B	1	Total 6	C 3	O 3	0	0
2	B	1	Total 6	C 3	O 3	0	0
2	B	1	Total 6	C 3	O 3	0	0
2	B	1	Total 6	C 3	O 3	0	0
2	C	1	Total 6	C 3	O 3	0	0
2	C	1	Total 6	C 3	O 3	0	0
2	C	1	Total 6	C 3	O 3	0	0
2	D	1	Total 6	C 3	O 3	0	0
2	D	1	Total 6	C 3	O 3	0	0
2	D	1	Total 6	C 3	O 3	0	0
2	D	1	Total 6	C 3	O 3	0	0
2	E	1	Total 6	C 3	O 3	0	0
2	E	1	Total 6	C 3	O 3	0	0
2	E	1	Total 6	C 3	O 3	0	0
2	E	1	Total 6	C 3	O 3	0	0
2	F	1	Total 6	C 3	O 3	0	0
2	F	1	Total 6	C 3	O 3	0	0
2	F	1	Total 6	C 3	O 3	0	0
2	G	1	Total 6	C 3	O 3	0	0

*Continued on next page...*

*Continued from previous page...*

Mol	Chain	Residues	Atoms			ZeroOcc	AltConf
2	G	1	Total 6	C 3	O 3	0	0
2	G	1	Total 6	C 3	O 3	0	0
2	I	1	Total 6	C 3	O 3	0	0
2	I	1	Total 6	C 3	O 3	0	0
2	J	1	Total 6	C 3	O 3	0	0
2	J	1	Total 6	C 3	O 3	0	0
2	K	1	Total 6	C 3	O 3	0	0
2	K	1	Total 6	C 3	O 3	0	0
2	K	1	Total 6	C 3	O 3	0	0
2	L	1	Total 6	C 3	O 3	0	0
2	L	1	Total 6	C 3	O 3	0	0
2	L	1	Total 6	C 3	O 3	0	0
2	M	1	Total 6	C 3	O 3	0	0
2	M	1	Total 6	C 3	O 3	0	0
2	M	1	Total 6	C 3	O 3	0	0
2	N	1	Total 6	C 3	O 3	0	0
2	N	1	Total 6	C 3	O 3	0	0
2	N	1	Total 6	C 3	O 3	0	0
2	N	1	Total 6	C 3	O 3	0	0
2	O	1	Total 6	C 3	O 3	0	0
2	P	1	Total 6	C 3	O 3	0	0



- Molecule 3 is 1,2-ETHANEDIOL (three-letter code: EDO) (formula: C<sub>2</sub>H<sub>6</sub>O<sub>2</sub>).

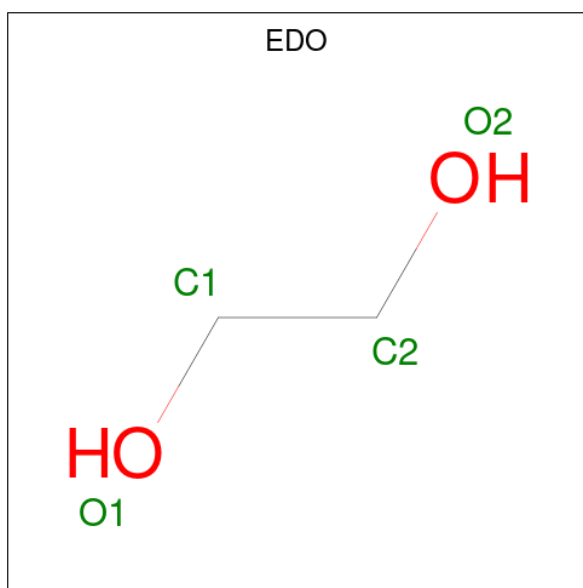

Mol	Chain	Residues	Atoms	ZeroOcc	AltConf
3	A	1	Total C O 4 2 2	0	0
3	C	1	Total C O 4 2 2	0	0
3	D	1	Total C O 4 2 2	0	0
3	I	1	Total C O 4 2 2	0	0
3	K	1	Total C O 4 2 2	0	0
3	L	1	Total C O 4 2 2	0	0

- Molecule 4 is DI(HYDROXYETHYL)ETHER (three-letter code: PEG) (formula: C<sub>4</sub>H<sub>10</sub>O<sub>3</sub>).



Mol	Chain	Residues	Atoms	ZeroOcc	AltConf
4	C	1	Total C O 7 4 3	0	0
4	G	1	Total C O 7 4 3	0	0
4	J	1	Total C O 7 4 3	0	0
4	L	1	Total C O 7 4 3	0	0

- Molecule 5 is water.

Mol	Chain	Residues	Atoms	ZeroOcc	AltConf
5	A	140	Total O 140 140	0	0
5	B	219	Total O 219 219	0	0
5	C	256	Total O 256 256	0	0
5	D	256	Total O 256 256	0	0
5	E	242	Total O 242 242	0	0
5	F	151	Total O 151 151	0	0
5	G	87	Total O 87 87	0	0
5	H	23	Total O 23 23	0	0

*Continued on next page...*

*Continued from previous page...*

Mol	Chain	Residues	Atoms	ZeroOcc	AltConf
5	I	183	Total O 183 183	0	0
5	J	238	Total O 238 238	0	0
5	K	220	Total O 220 220	0	0
5	L	253	Total O 253 253	0	0
5	M	239	Total O 239 239	0	0
5	N	252	Total O 252 252	0	0
5	O	160	Total O 160 160	0	0
5	P	90	Total O 90 90	0	0

### 3 Residue-property plots [i](#)

These plots are drawn for all protein, RNA, DNA and oligosaccharide chains in the entry. The first graphic for a chain summarises the proportions of the various outlier classes displayed in the second graphic. The second graphic shows the sequence view annotated by issues in geometry and electron density. Residues are color-coded according to the number of geometric quality criteria for which they contain at least one outlier: green = 0, yellow = 1, orange = 2 and red = 3 or more. A red dot above a residue indicates a poor fit to the electron density ( $RSRZ > 2$ ). Stretches of 2 or more consecutive residues without any outlier are shown as a green connector. Residues present in the sample, but not in the model, are shown in grey.

- Molecule 1: N-carbamoylputrescine amidohydrolase

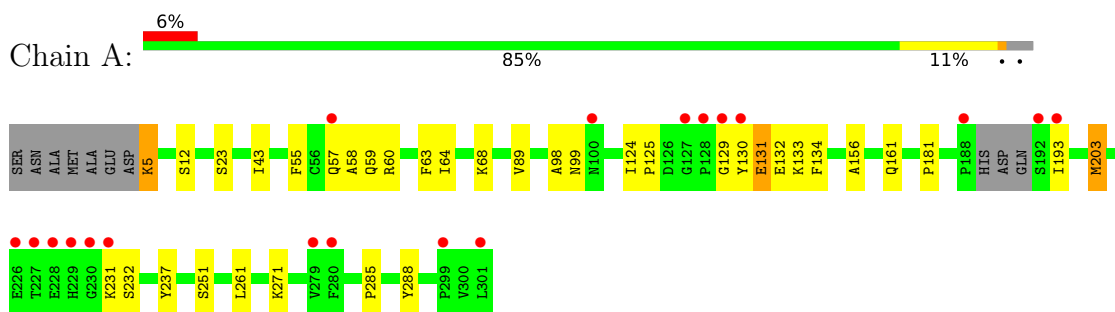

- Molecule 1: N-carbamoylputrescine amidohydrolase

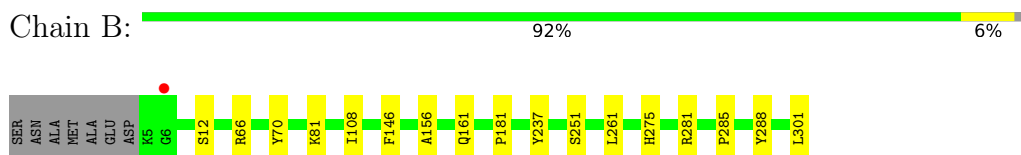

- Molecule 1: N-carbamoylputrescine amidohydrolase

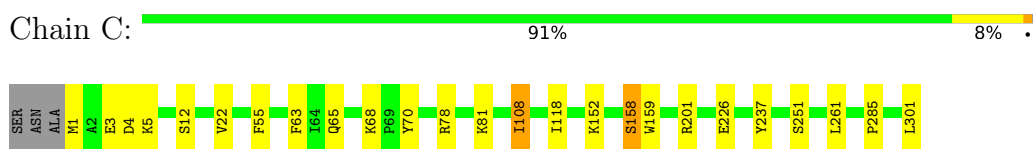

- Molecule 1: N-carbamoylputrescine amidohydrolase

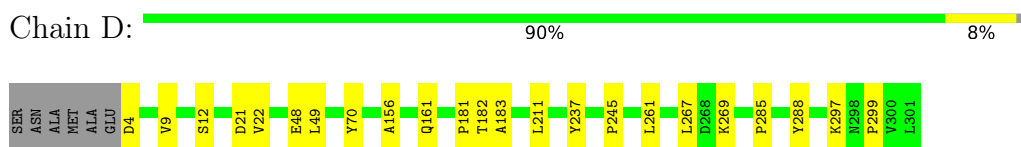

- Molecule 1: N-carbamoylputrescine amidohydrolase

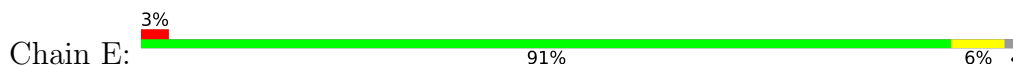

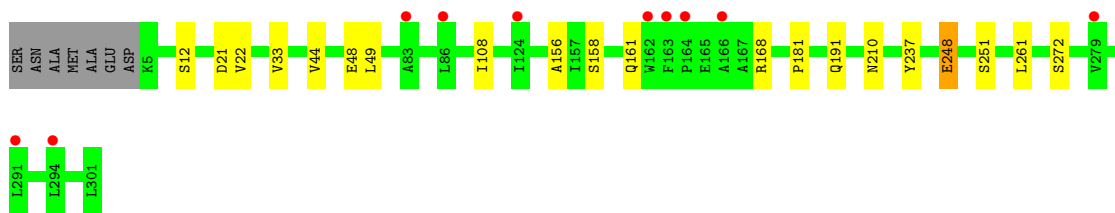

• Molecule 1: N-carbamoylputrescine amidohydrolase

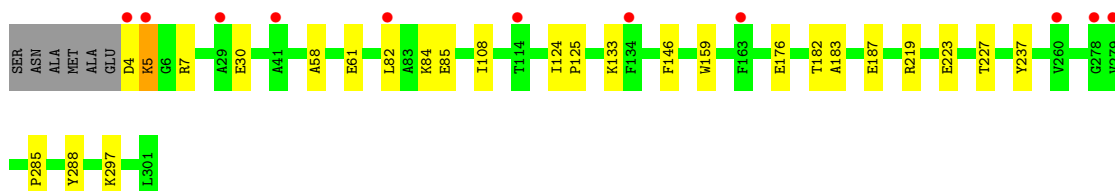
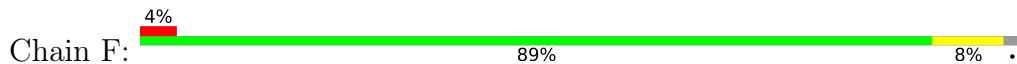

• Molecule 1: N-carbamoylputrescine amidohydrolase

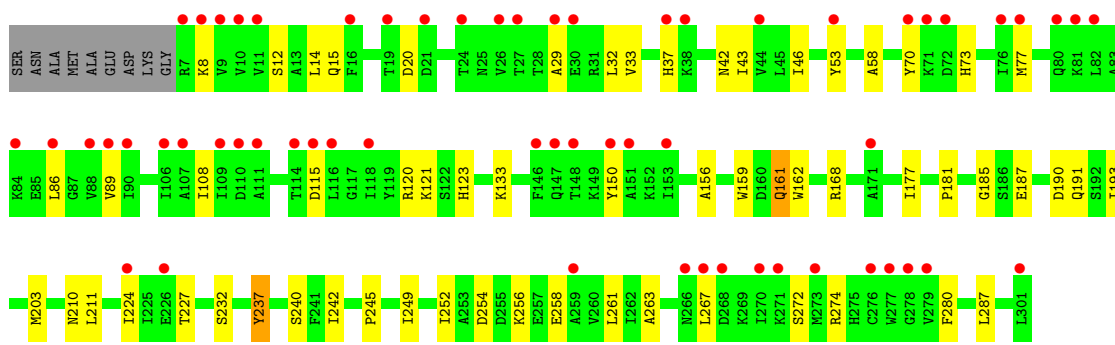
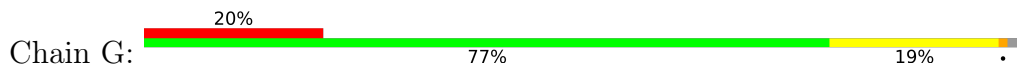

• Molecule 1: N-carbamoylputrescine amidohydrolase

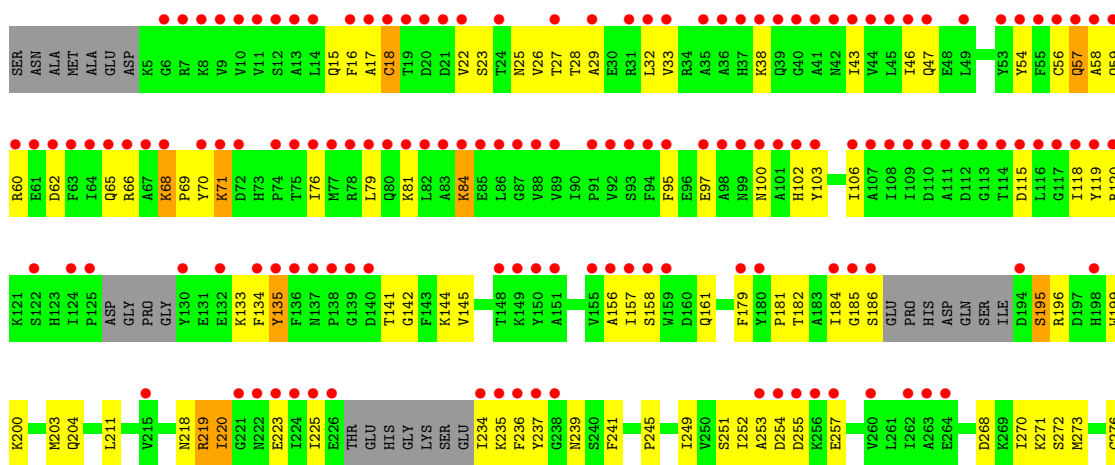

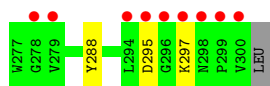

- Molecule 1: N-carbamoylputrescine amidohydrolase

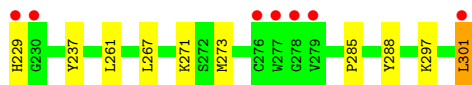
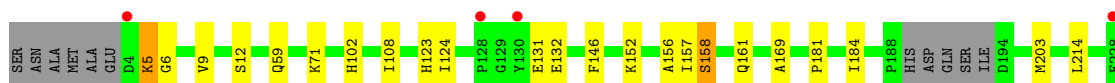
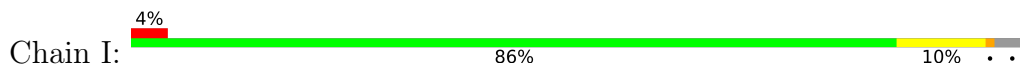

- Molecule 1: N-carbamoylputrescine amidohydrolase

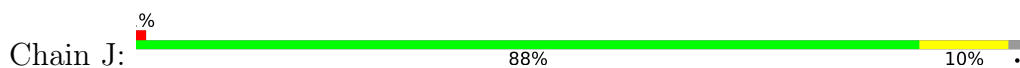

- Molecule 1: N-carbamoylputrescine amidohydrolase



- Molecule 1: N-carbamoylputrescine amidohydrolase



- Molecule 1: N-carbamoylputrescine amidohydrolase



- Molecule 1: N-carbamoylputrescine amidohydrolase





- Molecule 1: N-carbamoylputrescine amidohydrolase

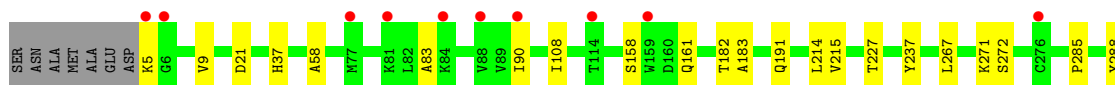
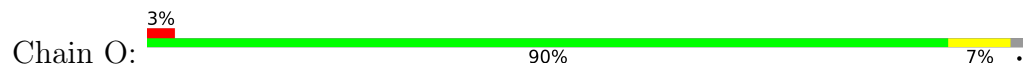

- Molecule 1: N-carbamoylputrescine amidohydrolase

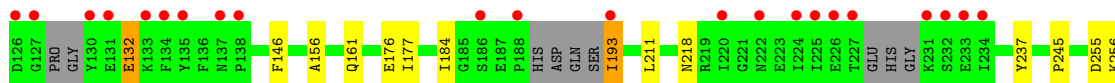
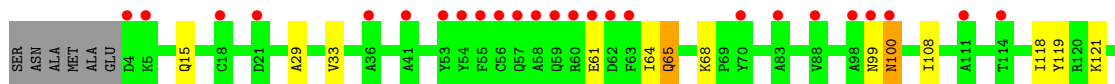
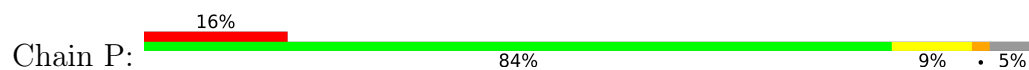

## 4 Data and refinement statistics i

Property	Value	Source
Space group	P 21 21 2	Depositor
Cell constants a, b, c, $\alpha$ , $\beta$ , $\gamma$	152.53Å 210.76Å 208.72Å 90.00° 90.00° 90.00°	Depositor
Resolution (Å)	49.43 – 2.39 49.43 – 2.39	Depositor EDS
% Data completeness (in resolution range)	99.2 (49.43-2.39) 99.3 (49.43-2.39)	Depositor EDS
$R_{merge}$	0.14	Depositor
$R_{sym}$	(Not available)	Depositor
$\langle I/\sigma(I) \rangle$ <sup>1</sup>	1.88 (at 2.39Å)	Xtrriage
Refinement program	REFMAC 5.8.0135	Depositor
R, $R_{free}$	0.158 , 0.212 0.170 , 0.218	Depositor DCC
$R_{free}$ test set	2615 reflections (1.00%)	wwPDB-VP
Wilson B-factor (Å <sup>2</sup> )	33.0	Xtrriage
Anisotropy	0.685	Xtrriage
Bulk solvent $k_{sol}$ (e/Å <sup>3</sup> ), $B_{sol}$ (Å <sup>2</sup> )	0.32 , 40.1	EDS
L-test for twinning <sup>2</sup>	$\langle  L  \rangle = 0.46$ , $\langle L^2 \rangle = 0.29$	Xtrriage
Estimated twinning fraction	0.000 for -h,l,k	Xtrriage
$F_o, F_c$ correlation	0.97	EDS
Total number of atoms	40889	wwPDB-VP
Average B, all atoms (Å <sup>2</sup> )	57.0	wwPDB-VP

Xtrriage's analysis on translational NCS is as follows: *The analyses of the Patterson function reveals a significant off-origin peak that is 42.31 % of the origin peak, indicating pseudo-translational symmetry. The chance of finding a peak of this or larger height randomly in a structure without pseudo-translational symmetry is equal to 2.0771e-04. The detected translational NCS is most likely also responsible for the elevated intensity ratio.*

<sup>1</sup>Intensities estimated from amplitudes.

<sup>2</sup>Theoretical values of  $\langle |L| \rangle$ ,  $\langle L^2 \rangle$  for acentric reflections are 0.5, 0.333 respectively for untwinned datasets, and 0.375, 0.2 for perfectly twinned datasets.



## 5 Model quality [i](#)

### 5.1 Standard geometry [i](#)

Bond lengths and bond angles in the following residue types are not validated in this section: PEG, GOL, EDO

The Z score for a bond length (or angle) is the number of standard deviations the observed value is removed from the expected value. A bond length (or angle) with  $|Z| > 5$  is considered an outlier worth inspection. RMSZ is the root-mean-square of all Z scores of the bond lengths (or angles).

Mol	Chain	Bond lengths		Bond angles	
		RMSZ	# Z  >5	RMSZ	# Z  >5
1	A	0.78	0/2390	0.84	0/3231
1	B	0.80	0/2422	0.82	0/3276
1	C	0.81	0/2449	0.85	0/3312
1	D	0.84	1/2427 (0.0%)	0.83	0/3283
1	E	0.76	0/2413	0.82	0/3264
1	F	0.72	0/2427	0.80	0/3283
1	G	0.80	0/2400	0.81	0/3248
1	H	0.67	0/2269	0.74	0/3065
1	I	0.81	0/2384	0.85	0/3223
1	J	0.83	0/2427	0.83	0/3283
1	K	0.81	0/2458	0.83	0/3324
1	L	0.84	0/2427	0.84	0/3283
1	M	0.79	0/2419	0.79	0/3272
1	N	0.82	0/2421	0.82	0/3275
1	O	0.76	0/2413	0.77	0/3264
1	P	0.68	0/2339	0.76	0/3160
All	All	0.78	1/38485 (0.0%)	0.81	0/52046

All (1) bond length outliers are listed below:

Mol	Chain	Res	Type	Atoms	Z	Observed(Å)	Ideal(Å)
1	D	70	TYR	CG-CD1	5.09	1.45	1.39

There are no bond angle outliers.

There are no chirality outliers.

There are no planarity outliers.

## 5.2 Too-close contacts [i](#)

In the following table, the Non-H and H(model) columns list the number of non-hydrogen atoms and hydrogen atoms in the chain respectively. The H(added) column lists the number of hydrogen atoms added and optimized by MolProbity. The Clashes column lists the number of clashes within the asymmetric unit, whereas Symm-Clashes lists symmetry-related clashes.

Mol	Chain	Non-H	H(model)	H(added)	Clashes	Symm-Clashes
1	A	2333	0	2304	25	0
1	B	2363	0	2325	8	0
1	C	2390	0	2351	14	0
1	D	2368	0	2328	10	0
1	E	2357	0	2319	8	0
1	F	2368	0	2328	18	0
1	G	2344	0	2303	37	0
1	H	2217	0	2198	81	0
1	I	2327	0	2292	20	0
1	J	2368	0	2328	17	0
1	K	2396	0	2357	12	0
1	L	2368	0	2328	11	0
1	M	2360	0	2324	7	0
1	N	2365	0	2323	9	0
1	O	2357	0	2319	10	0
1	P	2289	0	2259	19	0
2	A	12	0	16	0	0
2	B	30	0	40	1	0
2	C	18	0	24	0	0
2	D	24	0	32	1	0
2	E	24	0	32	0	0
2	F	18	0	24	2	0
2	G	18	0	24	1	0
2	I	12	0	16	0	0
2	J	12	0	16	1	0
2	K	18	0	24	1	0
2	L	18	0	24	0	0
2	M	18	0	24	0	0
2	N	24	0	32	0	0
2	O	6	0	8	1	0
2	P	6	0	8	2	0
3	A	4	0	6	1	0
3	C	4	0	6	1	0
3	D	4	0	6	0	0
3	I	4	0	6	0	0
3	K	4	0	6	2	0
3	L	4	0	6	2	0

*Continued on next page...*

*Continued from previous page...*

Mol	Chain	Non-H	H(model)	H(added)	Clashes	Symm-Clashes
4	C	7	0	10	0	0
4	G	7	0	10	0	0
4	J	7	0	10	0	0
4	L	7	0	10	0	0
5	A	140	0	0	2	0
5	B	219	0	0	3	0
5	C	256	0	0	5	0
5	D	256	0	0	3	0
5	E	242	0	0	4	0
5	F	151	0	0	1	0
5	G	87	0	0	1	0
5	H	23	0	0	1	0
5	I	183	0	0	1	0
5	J	238	0	0	5	0
5	K	220	0	0	2	0
5	L	253	0	0	4	0
5	M	239	0	0	3	0
5	N	252	0	0	1	0
5	O	160	0	0	1	0
5	P	90	0	0	1	0
All	All	40889	0	37406	300	0

The all-atom clashscore is defined as the number of clashes found per 1000 atoms (including hydrogen atoms). The all-atom clashscore for this structure is 4.

All (300) close contacts within the same asymmetric unit are listed below, sorted by their clash magnitude.

Atom-1	Atom-2	Interatomic distance (Å)	Clash overlap (Å)
1:H:60:ARG:HG2	1:H:62:ASP:HB2	1.21	1.19
1:G:20:ASP:HB2	1:G:53:TYR:CE2	1.95	1.00
1:H:196:ARG:HB3	1:H:237:TYR:CE1	1.97	0.98
2:O:401:GOL:H12	5:P:527:HOH:O	1.64	0.97
1:H:196:ARG:HB3	1:H:237:TYR:CZ	2.00	0.96
1:H:196:ARG:HA	1:H:237:TYR:OH	1.67	0.93
1:I:5:LYS:HE3	1:I:6:GLY:N	1.85	0.90
1:A:58:ALA:HB1	1:A:60:ARG:HG3	1.55	0.88
1:H:60:ARG:HG2	1:H:62:ASP:CB	2.05	0.86
1:H:196:ARG:CB	1:H:237:TYR:CE1	2.61	0.83
1:G:20:ASP:HB2	1:G:53:TYR:CD2	2.16	0.80
1:H:196:ARG:CA	1:H:237:TYR:OH	2.30	0.79
1:A:59:GLN:NE2	1:A:131:GLU:HG3	1.98	0.78

*Continued on next page...*

*Continued from previous page...*

Atom-1	Atom-2	Interatomic distance (Å)	Clash overlap (Å)
1:A:129:GLY:O	1:A:130:TYR:CD1	2.39	0.76
1:H:66:ARG:O	1:H:68:LYS:HD2	1.88	0.73
1:G:58:ALA:HB2	1:G:227:THR:HG22	1.70	0.72
1:J:5:LYS:HD2	1:J:6:GLY:N	2.05	0.71
1:H:70:TYR:CD1	1:H:71:LYS:HE2	2.25	0.71
1:H:196:ARG:CB	1:H:237:TYR:CZ	2.71	0.71
1:H:18:CYS:HB3	1:H:25:ASN:CG	2.12	0.70
1:F:58:ALA:HB2	1:F:227:THR:HG22	1.73	0.70
1:L:22:VAL:HG23	5:L:618:HOH:O	1.92	0.69
1:H:141:THR:HB	1:H:144:LYS:HE3	1.75	0.69
1:A:129:GLY:O	1:A:130:TYR:HD1	1.76	0.68
1:B:281:ARG:HD2	5:B:653:HOH:O	1.94	0.68
1:J:66:ARG:HD2	5:J:564:HOH:O	1.94	0.67
1:A:55:PHE:HB2	1:A:63:PHE:CD2	2.30	0.67
1:P:65:GLN:NE2	1:P:65:GLN:HA	2.10	0.67
3:K:404:EDO:H21	5:M:631:HOH:O	1.95	0.65
1:C:152:LYS:HE2	5:C:635:HOH:O	1.97	0.64
1:E:21:ASP:HB2	5:E:712:HOH:O	1.97	0.64
1:G:29:ALA:HB1	1:G:46:ILE:HD13	1.79	0.63
1:H:18:CYS:HB3	1:H:25:ASN:ND2	2.14	0.63
1:B:66:ARG:HD2	5:B:634:HOH:O	1.98	0.62
1:F:133:LYS:HB3	1:G:133:LYS:HD3	1.82	0.62
1:H:57:GLN:OE1	1:H:234:ILE:HD11	2.00	0.62
1:G:185:GLY:HA2	1:G:237:TYR:CD2	2.36	0.61
1:H:18:CYS:CB	1:H:25:ASN:ND2	2.64	0.61
1:E:12:SER:HA	1:E:261:LEU:O	2.00	0.60
1:H:156:ALA:O	1:H:181:PRO:HD2	2.01	0.60
1:A:58:ALA:CB	1:A:60:ARG:HG3	2.31	0.59
1:I:157:ILE:HG22	1:I:158:SER:HB3	1.83	0.59
1:F:183:ALA:HB2	5:F:535:HOH:O	2.01	0.59
1:G:43:ILE:HG23	1:G:89:VAL:HB	1.85	0.58
1:J:4:ASP:OD2	1:J:8:LYS:HD3	2.03	0.58
1:H:22:VAL:O	1:H:26:VAL:HG23	2.04	0.58
1:L:299:PRO:HB3	5:L:523:HOH:O	2.04	0.57
1:G:20:ASP:HB2	1:G:53:TYR:HE2	1.60	0.57
1:H:29:ALA:O	1:H:33:VAL:HG23	2.05	0.57
1:N:9:VAL:HG21	1:N:267:LEU:HD11	1.87	0.57
1:O:9:VAL:HG21	1:O:267:LEU:HD11	1.87	0.57
1:G:20:ASP:CB	1:G:53:TYR:CD2	2.87	0.56
1:C:251:SER:HB2	5:C:598:HOH:O	2.05	0.56
1:E:156:ALA:O	1:E:181:PRO:HD2	2.06	0.56

*Continued on next page...*

*Continued from previous page...*

Atom-1	Atom-2	Interatomic distance (Å)	Clash overlap (Å)
1:H:70:TYR:CE1	1:H:71:LYS:HE2	2.41	0.56
1:H:186:SER:N	1:H:234:ILE:HG23	2.21	0.56
1:H:204:GLN:NE2	1:H:249:ILE:HG12	2.21	0.56
1:G:42:ASN:ND2	1:G:150:TYR:CE1	2.74	0.55
1:I:156:ALA:O	1:I:181:PRO:HD2	2.05	0.55
1:H:196:ARG:HB2	1:H:237:TYR:CE1	2.42	0.55
1:C:108:ILE:HD13	1:C:108:ILE:N	2.21	0.55
1:G:15:GLN:O	1:G:258:GLU:HA	2.06	0.55
1:A:125:PRO:HG3	5:A:531:HOH:O	2.07	0.54
1:H:60:ARG:HE	1:H:62:ASP:CB	2.21	0.54
1:F:133:LYS:HB3	1:G:133:LYS:CD	2.38	0.54
5:E:649:HOH:O	2:F:401:GOL:H12	2.08	0.54
1:K:277:TRP:CZ3	2:K:402:GOL:H32	2.42	0.54
1:G:70:TYR:HH	1:G:115:ASP:CG	2.10	0.54
1:I:301:LEU:H	1:I:301:LEU:HD22	1.72	0.54
1:H:196:ARG:O	1:H:200:LYS:HB2	2.08	0.53
1:C:201:ARG:HD3	2:D:404:GOL:H2	1.90	0.53
1:A:12:SER:HA	1:A:261:LEU:O	2.07	0.53
1:G:254:ASP:HB2	5:G:538:HOH:O	2.07	0.53
1:H:17:ALA:HB2	1:H:220:ILE:CG2	2.39	0.53
1:P:193:ILE:O	1:P:193:ILE:HG13	2.07	0.53
1:G:108:ILE:N	1:G:108:ILE:HD12	2.24	0.53
1:G:168:ARG:NH1	1:G:210:ASN:OD1	2.42	0.52
1:H:69:PRO:HA	1:H:97:GLU:O	2.09	0.52
1:H:204:GLN:HE21	1:H:249:ILE:HG12	1.74	0.52
1:D:4:ASP:HA	1:D:269:LYS:NZ	2.25	0.52
1:A:58:ALA:HB1	1:A:60:ARG:CG	2.35	0.52
1:C:22:VAL:HG23	5:C:647:HOH:O	2.09	0.52
1:O:214:LEU:HD23	1:O:215:VAL:N	2.23	0.52
1:H:60:ARG:HE	1:H:62:ASP:CG	2.13	0.52
1:E:48:GLU:HG2	1:E:49:LEU:HG	1.92	0.52
1:O:182:THR:HG22	1:O:183:ALA:N	2.25	0.52
1:P:65:GLN:HA	1:P:65:GLN:HE21	1.74	0.52
1:A:43:ILE:HG12	1:A:89:VAL:HB	1.91	0.52
1:G:249:ILE:HG21	1:G:252:ILE:HB	1.91	0.52
1:M:191:GLN:O	1:M:191:GLN:HG2	2.10	0.52
1:L:4:ASP:HB3	5:L:631:HOH:O	2.09	0.52
1:H:161:GLN:HB2	1:H:203:MET:CE	2.40	0.51
1:A:55:PHE:C	1:A:57:GLN:N	2.62	0.51
1:P:29:ALA:O	1:P:33:VAL:HG23	2.10	0.51
1:H:245:PRO:HG3	1:H:270:ILE:HD13	1.92	0.51

*Continued on next page...*

*Continued from previous page...*

Atom-1	Atom-2	Interatomic distance (Å)	Clash overlap (Å)
1:H:199:TRP:O	1:H:203:MET:HG2	2.11	0.51
1:H:81:LYS:O	1:H:81:LYS:HD3	2.11	0.51
1:O:108:ILE:HD13	1:O:108:ILE:N	2.26	0.51
1:B:156:ALA:O	1:B:181:PRO:HD2	2.10	0.51
1:E:22:VAL:HG23	5:E:623:HOH:O	2.10	0.51
1:F:285:PRO:HA	1:F:288:TYR:CD2	2.46	0.51
1:H:237:TYR:HD1	1:H:237:TYR:O	1.94	0.51
5:J:616:HOH:O	3:L:405:EDO:H12	2.10	0.51
1:D:211:LEU:HA	1:D:245:PRO:O	2.12	0.50
1:G:177:ILE:HD11	1:G:267:LEU:HD11	1.93	0.50
1:A:5:LYS:HE3	1:A:5:LYS:HA	1.92	0.50
1:H:84:LYS:HG2	1:H:84:LYS:O	2.10	0.50
1:I:124:ILE:HG23	1:I:132:GLU:HG2	1.93	0.50
1:M:201:ARG:HD3	5:M:560:HOH:O	2.11	0.50
1:P:108:ILE:HG13	1:P:146:PHE:CD2	2.46	0.50
1:K:5:LYS:HA	1:K:5:LYS:HE3	1.93	0.50
1:B:70:TYR:CD2	2:B:405:GOL:H2	2.47	0.50
1:H:18:CYS:HB2	1:H:25:ASN:ND2	2.27	0.50
1:J:55:PHE:HB2	1:J:63:PHE:CD2	2.46	0.50
1:D:9:VAL:HG11	1:D:267:LEU:HD11	1.93	0.50
1:G:156:ALA:O	1:G:181:PRO:HD2	2.11	0.50
1:H:161:GLN:HE22	1:H:182:THR:CB	2.25	0.50
1:I:9:VAL:HG21	1:I:267:LEU:HD11	1.92	0.50
1:J:156:ALA:O	1:J:181:PRO:HD2	2.12	0.49
1:A:285:PRO:HA	1:A:288:TYR:CD2	2.47	0.49
3:A:403:EDO:H12	5:D:618:HOH:O	2.10	0.49
1:D:182:THR:HG22	1:D:183:ALA:N	2.27	0.49
1:B:12:SER:HA	1:B:261:LEU:O	2.12	0.49
1:H:47:GLN:OE1	1:H:219:ARG:HA	2.13	0.49
1:G:14:LEU:HD22	1:G:32:LEU:HB3	1.94	0.49
1:H:119:TYR:CE2	1:H:156:ALA:HA	2.47	0.48
1:H:17:ALA:HB2	1:H:220:ILE:HG22	1.95	0.48
1:A:55:PHE:C	1:A:57:GLN:H	2.16	0.48
1:M:185:GLY:HA2	1:M:237:TYR:CD2	2.48	0.48
1:N:182:THR:HG22	1:N:183:ALA:N	2.29	0.48
1:G:287:LEU:HD22	1:H:142:GLY:HA2	1.96	0.48
1:J:73:HIS:HB3	1:J:76:ILE:HG13	1.94	0.48
5:J:616:HOH:O	3:L:405:EDO:C1	2.62	0.48
1:L:211:LEU:HA	1:L:245:PRO:O	2.14	0.48
1:I:273:MET:HE1	5:I:683:HOH:O	2.13	0.47
1:H:196:ARG:CB	1:H:237:TYR:OH	2.61	0.47

*Continued on next page...*

*Continued from previous page...*

Atom-1	Atom-2	Interatomic distance (Å)	Clash overlap (Å)
1:M:182:THR:HG22	1:M:183:ALA:N	2.29	0.47
1:H:58:ALA:O	1:H:59:GLN:HB3	2.14	0.47
1:J:12:SER:HA	1:J:261:LEU:O	2.14	0.47
1:H:16:PHE:C	1:H:220:ILE:HG22	2.35	0.47
1:I:5:LYS:HE3	1:I:5:LYS:C	2.34	0.47
1:O:285:PRO:HA	1:O:288:TYR:CD2	2.50	0.46
1:A:156:ALA:O	1:A:181:PRO:HD2	2.16	0.46
1:H:295:ASP:OD1	1:H:297:LYS:N	2.46	0.46
1:A:55:PHE:HB2	1:A:63:PHE:HD2	1.78	0.46
1:I:71:LYS:HB2	1:I:71:LYS:HE3	1.79	0.46
1:J:20:ASP:HA	5:J:501:HOH:O	2.16	0.46
1:A:132:GLU:C	1:A:134:PHE:H	2.19	0.46
1:H:185:GLY:O	1:H:186:SER:CB	2.64	0.46
1:P:100:ASN:HD22	1:P:100:ASN:N	2.14	0.46
1:F:4:ASP:HB3	1:F:5:LYS:H	1.51	0.46
1:F:133:LYS:HD2	1:G:133:LYS:HB3	1.98	0.46
1:K:118:ILE:HG21	1:K:118:ILE:HD13	1.64	0.46
1:L:12:SER:HA	1:L:261:LEU:O	2.16	0.46
1:M:108:ILE:HD13	1:M:108:ILE:N	2.31	0.46
1:D:299:PRO:HB3	5:D:549:HOH:O	2.16	0.45
1:J:29:ALA:O	1:J:33:VAL:HG23	2.16	0.45
1:N:176:GLU:O	1:N:177:ILE:HG13	2.16	0.45
1:P:121:LYS:NZ	1:P:132:GLU:OE2	2.46	0.45
1:C:12:SER:HA	1:C:261:LEU:O	2.16	0.45
1:J:212:VAL:HG23	1:J:212:VAL:O	2.15	0.45
1:C:81:LYS:NZ	5:C:509:HOH:O	2.49	0.45
1:F:30:GLU:HG3	1:F:82:LEU:HD22	1.99	0.45
1:I:12:SER:HA	1:I:261:LEU:O	2.17	0.45
1:H:218:ASN:OD1	1:H:219:ARG:N	2.50	0.45
1:H:252:ILE:O	1:H:252:ILE:HG23	2.17	0.45
1:I:108:ILE:HG13	1:I:146:PHE:CD1	2.52	0.45
1:K:248:GLU:HG2	5:K:519:HOH:O	2.15	0.45
1:P:211:LEU:HA	1:P:245:PRO:O	2.16	0.45
1:H:161:GLN:HE22	1:H:182:THR:HB	1.81	0.45
2:G:402:GOL:O3	1:H:273:MET:HG3	2.17	0.45
1:K:285:PRO:HD2	3:K:404:EDO:H22	1.99	0.45
1:A:130:TYR:HB2	5:A:615:HOH:O	2.17	0.44
1:G:274:ARG:HD2	1:G:280:PHE:HE2	1.81	0.44
1:N:12:SER:HA	1:N:261:LEU:O	2.17	0.44
1:O:214:LEU:HD23	1:O:214:LEU:C	2.37	0.44
1:C:285:PRO:HD2	3:C:405:EDO:H22	1.98	0.44

*Continued on next page...*

*Continued from previous page...*

Atom-1	Atom-2	Interatomic distance (Å)	Clash overlap (Å)
1:F:182:THR:HG22	1:F:183:ALA:N	2.33	0.44
1:H:16:PHE:HD2	1:H:32:LEU:HD12	1.82	0.44
1:J:274:ARG:HE	2:J:402:GOL:H12	1.83	0.44
1:L:182:THR:HG22	1:L:183:ALA:N	2.33	0.44
1:P:255:ASP:OD1	1:P:256:LYS:HG2	2.16	0.44
1:A:271:LYS:HE2	1:C:65:GLN:HE22	1.82	0.44
1:H:102:HIS:HB2	1:H:135:TYR:O	2.17	0.44
1:L:248:GLU:HB3	5:L:509:HOH:O	2.18	0.44
1:H:15:GLN:NE2	1:H:220:ILE:HD13	2.32	0.44
1:H:211:LEU:HA	1:H:245:PRO:O	2.18	0.44
1:P:273:MET:HG3	2:P:401:GOL:O1	2.17	0.44
1:H:106:ILE:O	1:H:106:ILE:HG23	2.17	0.44
1:K:3:GLU:HG2	1:K:4:ASP:N	2.32	0.44
1:N:9:VAL:HG21	1:N:267:LEU:CD1	2.48	0.44
1:A:124:ILE:HA	1:A:125:PRO:HD2	1.79	0.44
1:J:5:LYS:HD2	1:J:5:LYS:C	2.38	0.43
1:L:285:PRO:HA	1:L:288:TYR:CD2	2.53	0.43
1:I:123:HIS:C	1:I:124:ILE:HD13	2.39	0.43
1:D:12:SER:HA	1:D:261:LEU:O	2.19	0.43
1:G:12:SER:HA	1:G:261:LEU:O	2.18	0.43
1:H:254:ASP:OD1	1:H:257:GLU:HG3	2.18	0.43
1:J:108:ILE:HG13	1:J:146:PHE:CD1	2.53	0.43
1:P:277:TRP:CE3	2:P:401:GOL:H2	2.54	0.43
1:I:59:GLN:OE1	1:I:131:GLU:HG3	2.19	0.43
1:H:219:ARG:HD2	1:H:223:GLU:OE2	2.19	0.43
1:I:124:ILE:CG2	1:I:132:GLU:HG2	2.48	0.43
1:C:68:LYS:HE2	5:C:593:HOH:O	2.18	0.43
1:H:103:TYR:CG	1:H:120:ARG:HD3	2.53	0.43
1:H:270:ILE:HD11	5:H:423:HOH:O	2.16	0.43
1:J:30:GLU:HG2	5:J:693:HOH:O	2.17	0.43
1:P:15:GLN:HG3	1:P:218:ASN:O	2.18	0.43
1:F:61:GLU:HG2	1:H:272:SER:OG	2.19	0.43
1:M:71:LYS:HE2	5:M:723:HOH:O	2.18	0.43
1:P:99:ASN:HB3	1:P:100:ASN:H	1.65	0.43
1:H:16:PHE:CE1	1:H:47:GLN:NE2	2.87	0.43
1:H:254:ASP:OD1	1:H:254:ASP:N	2.52	0.43
1:F:124:ILE:O	1:F:133:LYS:NZ	2.49	0.43
1:I:271:LYS:HE2	1:K:65:GLN:HE22	1.84	0.43
1:O:37:HIS:CE1	5:O:535:HOH:O	2.72	0.42
1:B:108:ILE:HG13	1:B:146:PHE:CD1	2.54	0.42
1:H:28:THR:O	1:H:28:THR:CG2	2.66	0.42

*Continued on next page...*



*Continued from previous page...*

Atom-1	Atom-2	Interatomic distance (Å)	Clash overlap (Å)
1:H:56:CYS:HA	1:H:135:TYR:HE2	1.84	0.42
1:F:125:PRO:HB3	1:F:159:TRP:CD2	2.54	0.42
1:P:119:TYR:CE2	1:P:156:ALA:HA	2.55	0.42
1:G:123:HIS:NE2	1:H:288:TYR:OH	2.46	0.42
1:H:195:SER:O	1:H:237:TYR:OH	2.35	0.42
1:H:220:ILE:HD11	1:H:255:ASP:O	2.19	0.42
1:I:152:LYS:HE3	1:I:152:LYS:HB2	1.84	0.42
1:G:161:GLN:HB2	1:G:203:MET:SD	2.59	0.42
1:K:49:LEU:HA	5:K:646:HOH:O	2.19	0.42
1:N:161:GLN:HB3	1:N:180:TYR:CD1	2.55	0.42
1:P:176:GLU:C	1:P:177:ILE:HG13	2.39	0.42
1:B:285:PRO:HA	1:B:288:TYR:CD2	2.54	0.42
1:C:55:PHE:HB2	1:C:63:PHE:CD2	2.55	0.42
1:G:287:LEU:HD22	1:H:142:GLY:CA	2.49	0.42
1:O:5:LYS:HB3	1:O:5:LYS:NZ	2.34	0.42
1:G:29:ALA:O	1:G:33:VAL:HG23	2.19	0.42
1:H:157:ILE:HG22	1:H:158:SER:HB2	2.01	0.42
1:P:285:PRO:HA	1:P:288:TYR:CD2	2.55	0.42
1:C:78:ARG:O	1:C:81:LYS:HB2	2.20	0.42
1:I:169:ALA:HB1	1:J:290:VAL:HG11	2.02	0.42
1:D:48:GLU:HG2	1:D:49:LEU:HG	2.01	0.42
1:E:33:VAL:HG22	1:E:44:VAL:HG11	2.02	0.42
5:N:686:HOH:O	1:P:273:MET:HB2	2.20	0.42
1:G:190:ASP:HB3	1:G:193:ILE:HD12	2.02	0.41
1:H:241:PHE:HA	1:H:251:SER:O	2.21	0.41
1:I:285:PRO:HA	1:I:288:TYR:CD2	2.54	0.41
1:P:108:ILE:HG13	1:P:146:PHE:CE2	2.55	0.41
1:A:98:ALA:O	1:A:99:ASN:CB	2.68	0.41
1:F:84:LYS:O	1:F:85:GLU:C	2.57	0.41
1:G:211:LEU:HD12	1:G:245:PRO:O	2.20	0.41
1:M:214:LEU:HD23	1:M:214:LEU:C	2.40	0.41
1:A:132:GLU:C	1:A:134:PHE:N	2.73	0.41
1:D:285:PRO:HA	1:D:288:TYR:CD2	2.55	0.41
1:H:54:TYR:HB3	1:H:236:PHE:HZ	1.86	0.41
1:H:161:GLN:HB2	1:H:203:MET:HE1	2.02	0.41
1:I:214:LEU:C	1:I:214:LEU:HD23	2.41	0.41
1:B:81:LYS:HE3	5:B:702:HOH:O	2.20	0.41
1:E:168:ARG:HD3	1:E:210:ASN:OD1	2.20	0.41
1:G:120:ARG:O	1:G:121:LYS:C	2.59	0.41
1:H:268:ASP:O	1:H:271:LYS:HB3	2.20	0.41
1:J:285:PRO:HA	1:J:288:TYR:CD2	2.56	0.41

*Continued on next page...*

*Continued from previous page...*

Atom-1	Atom-2	Interatomic distance (Å)	Clash overlap (Å)
1:D:156:ALA:O	1:D:181:PRO:HD2	2.20	0.41
1:F:61:GLU:HG3	1:H:276[B]:CYS:HB3	2.02	0.41
1:G:73:HIS:O	1:G:77:MET:HG3	2.20	0.41
1:H:28:THR:O	1:H:28:THR:HG22	2.20	0.41
1:E:248:GLU:HG2	5:E:606:HOH:O	2.20	0.41
1:K:107:ALA:HA	1:K:118:ILE:HG22	2.01	0.41
1:K:108:ILE:HG13	1:K:146:PHE:CD1	2.55	0.41
1:G:159:TRP:CE3	1:G:162:TRP:CD1	3.08	0.41
1:H:237:TYR:CD1	1:H:237:TYR:C	2.94	0.41
1:N:54:TYR:CE2	1:N:56:CYS:HB2	2.56	0.41
1:O:83:ALA:HB2	1:O:90:ILE:HD12	2.03	0.41
1:F:7:ARG:NH2	1:F:176:GLU:OE1	2.51	0.41
1:G:37:HIS:CD2	1:G:86:LEU:HB3	2.55	0.41
1:G:224:ILE:HA	1:G:232:SER:O	2.21	0.41
1:I:161:GLN:HB2	1:I:203:MET:SD	2.60	0.41
1:C:70:TYR:CZ	1:C:118:ILE:HG23	2.56	0.41
1:H:219:ARG:CG	1:H:236:PHE:CD2	3.04	0.41
1:K:3:GLU:CG	1:K:4:ASP:N	2.84	0.41
1:L:109:ILE:HD13	1:L:109:ILE:N	2.36	0.41
1:O:58:ALA:HB2	1:O:227:THR:HG22	2.02	0.41
1:A:161:GLN:O	1:A:203:MET:HE1	2.21	0.40
1:F:108:ILE:HG13	1:F:146:PHE:CD1	2.57	0.40
1:P:61:GLU:HA	1:P:64:ILE:HD13	2.03	0.40
1:A:98:ALA:O	1:A:99:ASN:HB2	2.19	0.40
1:A:131:GLU:O	1:A:134:PHE:HB2	2.20	0.40
1:C:158:SER:HB3	1:C:159:TRP:H	1.63	0.40
1:H:239:ASN:HA	1:H:253:ALA:O	2.21	0.40
1:F:187:GLU:OE1	2:F:401:GOL:O2	2.38	0.40
1:H:234:ILE:CG2	1:H:235:LYS:N	2.84	0.40
1:N:45:LEU:HD11	1:N:181:PRO:HG3	2.03	0.40
1:D:22:VAL:HG23	5:D:623:HOH:O	2.21	0.40
1:F:219:ARG:HD3	1:F:223:GLU:OE2	2.22	0.40
1:H:43:ILE:HG21	1:H:179:PHE:CZ	2.57	0.40
1:H:254:ASP:OD1	1:H:257:GLU:CG	2.70	0.40
1:J:108:ILE:HG13	1:J:146:PHE:CE1	2.57	0.40
1:G:240:SER:O	1:G:261:LEU:HD11	2.21	0.40
1:G:242:ILE:HG21	1:G:263:ALA:HB3	2.04	0.40
1:H:57:GLN:OE1	1:H:234:ILE:CD1	2.66	0.40
1:K:285:PRO:HG2	1:L:300:VAL:HG11	2.03	0.40
1:L:118:ILE:HD13	1:L:118:ILE:HG21	1.74	0.40
1:N:156:ALA:O	1:N:181:PRO:HD2	2.21	0.40

There are no symmetry-related clashes.

## 5.3 Torsion angles [i](#)

### 5.3.1 Protein backbone [i](#)

In the following table, the Percentiles column shows the percent Ramachandran outliers of the chain as a percentile score with respect to all X-ray entries followed by that with respect to entries of similar resolution.

The Analysed column shows the number of residues for which the backbone conformation was analysed, and the total number of residues.

Mol	Chain	Analysed	Favoured	Allowed	Outliers	Percentiles	
1	A	291/304 (96%)	278 (96%)	13 (4%)	0	100	100
1	B	296/304 (97%)	287 (97%)	9 (3%)	0	100	100
1	C	300/304 (99%)	283 (94%)	17 (6%)	0	100	100
1	D	297/304 (98%)	287 (97%)	10 (3%)	0	100	100
1	E	295/304 (97%)	285 (97%)	10 (3%)	0	100	100
1	F	297/304 (98%)	285 (96%)	12 (4%)	0	100	100
1	G	293/304 (96%)	270 (92%)	23 (8%)	0	100	100
1	H	271/304 (89%)	244 (90%)	27 (10%)	0	100	100
1	I	290/304 (95%)	278 (96%)	12 (4%)	0	100	100
1	J	297/304 (98%)	288 (97%)	9 (3%)	0	100	100
1	K	301/304 (99%)	293 (97%)	8 (3%)	0	100	100
1	L	297/304 (98%)	289 (97%)	8 (3%)	0	100	100
1	M	296/304 (97%)	286 (97%)	10 (3%)	0	100	100
1	N	296/304 (97%)	284 (96%)	12 (4%)	0	100	100
1	O	295/304 (97%)	281 (95%)	14 (5%)	0	100	100
1	P	280/304 (92%)	267 (95%)	13 (5%)	0	100	100
All	All	4692/4864 (96%)	4485 (96%)	207 (4%)	0	100	100

There are no Ramachandran outliers to report.

### 5.3.2 Protein sidechains [i](#)

In the following table, the Percentiles column shows the percent sidechain outliers of the chain as a percentile score with respect to all X-ray entries followed by that with respect to entries of similar resolution.

The Analysed column shows the number of residues for which the sidechain conformation was analysed, and the total number of residues.

Mol	Chain	Analysed	Rotameric	Outliers	Percentiles	
1	A	245/252 (97%)	233 (95%)	12 (5%)	25	40
1	B	248/252 (98%)	243 (98%)	5 (2%)	55	74
1	C	251/252 (100%)	242 (96%)	9 (4%)	35	54
1	D	249/252 (99%)	245 (98%)	4 (2%)	62	79
1	E	247/252 (98%)	239 (97%)	8 (3%)	39	59
1	F	249/252 (99%)	246 (99%)	3 (1%)	71	85
1	G	246/252 (98%)	239 (97%)	7 (3%)	43	63
1	H	232/252 (92%)	207 (89%)	25 (11%)	6	9
1	I	244/252 (97%)	236 (97%)	8 (3%)	38	57
1	J	249/252 (99%)	242 (97%)	7 (3%)	43	63
1	K	252/252 (100%)	248 (98%)	4 (2%)	62	79
1	L	249/252 (99%)	247 (99%)	2 (1%)	81	91
1	M	248/252 (98%)	246 (99%)	2 (1%)	81	91
1	N	248/252 (98%)	243 (98%)	5 (2%)	55	74
1	O	247/252 (98%)	240 (97%)	7 (3%)	43	63
1	P	240/252 (95%)	228 (95%)	12 (5%)	24	40
All	All	3944/4032 (98%)	3824 (97%)	120 (3%)	40	61

All (120) residues with a non-rotameric sidechain are listed below:

Mol	Chain	Res	Type
1	A	5	LYS
1	A	23	SER
1	A	64	ILE
1	A	68	LYS
1	A	131	GLU
1	A	133	LYS
1	A	193	ILE
1	A	203	MET
1	A	231	LYS
1	A	232	SER
1	A	237	TYR
1	A	251	SER
1	B	161	GLN
1	B	237	TYR

*Continued on next page...*

*Continued from previous page...*

<b>Mol</b>	<b>Chain</b>	<b>Res</b>	<b>Type</b>
1	B	251	SER
1	B	275	HIS
1	B	301	LEU
1	C	1	MET
1	C	3	GLU
1	C	4	ASP
1	C	5	LYS
1	C	108	ILE
1	C	158	SER
1	C	226	GLU
1	C	237	TYR
1	C	301	LEU
1	D	21	ASP
1	D	161	GLN
1	D	237	TYR
1	D	297	LYS
1	E	108	ILE
1	E	158	SER
1	E	161	GLN
1	E	191	GLN
1	E	237	TYR
1	E	248	GLU
1	E	251	SER
1	E	272	SER
1	F	5	LYS
1	F	237	TYR
1	F	297	LYS
1	G	8	LYS
1	G	161	GLN
1	G	187	GLU
1	G	191	GLN
1	G	237	TYR
1	G	256	LYS
1	G	272	SER
1	H	18	CYS
1	H	23	SER
1	H	27	THR
1	H	38	LYS
1	H	46	ILE
1	H	57	GLN
1	H	65	GLN
1	H	68	LYS

*Continued on next page...*

*Continued from previous page...*

<b>Mol</b>	<b>Chain</b>	<b>Res</b>	<b>Type</b>
1	H	71	LYS
1	H	76	ILE
1	H	79	LEU
1	H	84	LYS
1	H	95	PHE
1	H	100	ASN
1	H	115	ASP
1	H	118	ILE
1	H	133	LYS
1	H	134	PHE
1	H	135	TYR
1	H	145	VAL
1	H	184	ILE
1	H	195	SER
1	H	219	ARG
1	H	220	ILE
1	H	225	ILE
1	I	5	LYS
1	I	102	HIS
1	I	158	SER
1	I	184	ILE
1	I	229	HIS
1	I	237	TYR
1	I	297	LYS
1	I	301	LEU
1	J	149	LYS
1	J	161	GLN
1	J	211	LEU
1	J	237	TYR
1	J	251	SER
1	J	272	SER
1	J	301	LEU
1	K	4	ASP
1	K	5	LYS
1	K	158	SER
1	K	237	TYR
1	L	5	LYS
1	L	237	TYR
1	M	108	ILE
1	M	237	TYR
1	N	5	LYS
1	N	158	SER

*Continued on next page...*

*Continued from previous page...*

Mol	Chain	Res	Type
1	N	161	GLN
1	N	237	TYR
1	N	251	SER
1	O	21	ASP
1	O	158	SER
1	O	161	GLN
1	O	191	GLN
1	O	237	TYR
1	O	271	LYS
1	O	272	SER
1	P	65	GLN
1	P	68	LYS
1	P	100	ASN
1	P	118	ILE
1	P	132	GLU
1	P	161	GLN
1	P	184	ILE
1	P	193	ILE
1	P	237	TYR
1	P	273	MET
1	P	297	LYS
1	P	300	VAL

Sometimes sidechains can be flipped to improve hydrogen bonding and reduce clashes. All (33) such sidechains are listed below:

Mol	Chain	Res	Type
1	A	59	GLN
1	A	161	GLN
1	B	65	GLN
1	B	102	HIS
1	C	65	GLN
1	D	65	GLN
1	D	204	GLN
1	E	65	GLN
1	F	65	GLN
1	F	222	ASN
1	G	65	GLN
1	G	102	HIS
1	G	147	GLN
1	G	189	HIS
1	H	25	ASN
1	H	161	GLN

*Continued on next page...*

*Continued from previous page...*

Mol	Chain	Res	Type
1	H	204	GLN
1	H	222	ASN
1	I	161	GLN
1	J	65	GLN
1	K	65	GLN
1	L	65	GLN
1	M	59	GLN
1	M	65	GLN
1	N	59	GLN
1	N	65	GLN
1	O	65	GLN
1	O	102	HIS
1	O	189	HIS
1	P	57	GLN
1	P	65	GLN
1	P	100	ASN
1	P	161	GLN

### 5.3.3 RNA [i](#)

There are no RNA molecules in this entry.

### 5.4 Non-standard residues in protein, DNA, RNA chains [i](#)

There are no non-standard protein/DNA/RNA residues in this entry.

### 5.5 Carbohydrates [i](#)

There are no monosaccharides in this entry.

### 5.6 Ligand geometry [i](#)

53 ligands are modelled in this entry.

In the following table, the Counts columns list the number of bonds (or angles) for which Mogul statistics could be retrieved, the number of bonds (or angles) that are observed in the model and the number of bonds (or angles) that are defined in the Chemical Component Dictionary. The Link column lists molecule types, if any, to which the group is linked. The Z score for a bond length (or angle) is the number of standard deviations the observed value is removed from the expected value. A bond length (or angle) with  $|Z| > 2$  is considered an outlier worth inspection. RMSZ is the root-mean-square of all Z scores of the bond lengths (or angles).



Mol	Type	Chain	Res	Link	Bond lengths			Bond angles		
					Counts	RMSZ	# Z  > 2	Counts	RMSZ	# Z  > 2
2	GOL	F	401	-	5,5,5	0.87	0	5,5,5	0.66	0
2	GOL	E	404	-	5,5,5	0.56	0	5,5,5	0.32	0
3	EDO	D	405	-	3,3,3	0.63	0	2,2,2	0.12	0
2	GOL	L	403	-	5,5,5	0.48	0	5,5,5	0.33	0
4	PEG	L	404	-	6,6,6	0.54	0	5,5,5	0.26	0
2	GOL	J	401	-	5,5,5	0.40	0	5,5,5	0.61	0
2	GOL	N	404	-	5,5,5	0.67	0	5,5,5	0.72	0
4	PEG	G	404	-	6,6,6	0.53	0	5,5,5	0.26	0
2	GOL	D	403	-	5,5,5	0.52	0	5,5,5	0.38	0
2	GOL	N	403	-	5,5,5	0.46	0	5,5,5	0.40	0
2	GOL	B	404	-	5,5,5	0.34	0	5,5,5	0.57	0
2	GOL	B	405	-	5,5,5	0.68	0	5,5,5	0.39	0
2	GOL	A	401	-	5,5,5	0.59	0	5,5,5	0.40	0
2	GOL	I	401	-	5,5,5	0.43	0	5,5,5	0.74	0
2	GOL	K	403	-	5,5,5	0.49	0	5,5,5	0.21	0
2	GOL	M	401	-	5,5,5	0.94	0	5,5,5	1.08	0
2	GOL	C	403	-	5,5,5	0.55	0	5,5,5	0.76	0
2	GOL	M	402	-	5,5,5	0.25	0	5,5,5	0.22	0
2	GOL	D	402	-	5,5,5	0.33	0	5,5,5	0.28	0
2	GOL	G	402	-	5,5,5	0.43	0	5,5,5	0.44	0
4	PEG	J	403	-	6,6,6	0.60	0	5,5,5	0.25	0
2	GOL	K	402	-	5,5,5	0.39	0	5,5,5	0.32	0
4	PEG	C	404	-	6,6,6	0.62	0	5,5,5	0.41	0
2	GOL	G	401	-	5,5,5	0.64	0	5,5,5	0.49	0
2	GOL	F	403	-	5,5,5	0.46	0	5,5,5	0.33	0
2	GOL	L	402	-	5,5,5	0.36	0	5,5,5	0.09	0
2	GOL	K	401	-	5,5,5	1.05	0	5,5,5	0.54	0
2	GOL	A	402	-	5,5,5	0.38	0	5,5,5	0.46	0
2	GOL	J	402	-	5,5,5	0.44	0	5,5,5	0.45	0
2	GOL	N	402	-	5,5,5	0.61	0	5,5,5	0.40	0
3	EDO	L	405	-	3,3,3	0.48	0	2,2,2	0.27	0
2	GOL	L	401	-	5,5,5	1.02	0	5,5,5	0.95	0
2	GOL	N	401	-	5,5,5	0.72	0	5,5,5	0.55	0
2	GOL	E	403	-	5,5,5	0.36	0	5,5,5	0.29	0
2	GOL	C	402	-	5,5,5	0.36	0	5,5,5	0.26	0
2	GOL	E	402	-	5,5,5	0.51	0	5,5,5	0.69	0
2	GOL	B	401	-	5,5,5	0.96	0	5,5,5	0.69	0
3	EDO	K	404	-	3,3,3	0.45	0	2,2,2	0.37	0
2	GOL	I	402	-	5,5,5	0.53	0	5,5,5	0.37	0
2	GOL	B	403	-	5,5,5	0.57	0	5,5,5	0.77	0
3	EDO	A	403	-	3,3,3	0.52	0	2,2,2	0.18	0
2	GOL	O	401	-	5,5,5	0.52	0	5,5,5	0.78	0
2	GOL	M	403	-	5,5,5	0.45	0	5,5,5	0.58	0

Mol	Type	Chain	Res	Link	Bond lengths			Bond angles		
					Counts	RMSZ	# Z  > 2	Counts	RMSZ	# Z  > 2
2	GOL	C	401	-	5,5,5	1.18	0	5,5,5	0.83	0
2	GOL	E	401	-	5,5,5	1.18	0	5,5,5	0.92	0
2	GOL	B	402	-	5,5,5	0.28	0	5,5,5	0.49	0
2	GOL	P	401	-	5,5,5	0.29	0	5,5,5	0.71	0
2	GOL	D	404	-	5,5,5	0.72	0	5,5,5	0.53	0
2	GOL	F	402	-	5,5,5	0.40	0	5,5,5	0.36	0
3	EDO	I	403	-	3,3,3	0.57	0	2,2,2	0.04	0
2	GOL	D	401	-	5,5,5	0.94	0	5,5,5	0.74	0
3	EDO	C	405	-	3,3,3	0.49	0	2,2,2	0.31	0
2	GOL	G	403	-	5,5,5	0.39	0	5,5,5	0.29	0

In the following table, the Chirals column lists the number of chiral outliers, the number of chiral centers analysed, the number of these observed in the model and the number defined in the Chemical Component Dictionary. Similar counts are reported in the Torsion and Rings columns. '-' means no outliers of that kind were identified.

Mol	Type	Chain	Res	Link	Chirals	Torsions	Rings
2	GOL	F	401	-	-	4/4/4/4	-
2	GOL	E	404	-	-	2/4/4/4	-
3	EDO	D	405	-	-	0/1/1/1	-
2	GOL	L	403	-	-	2/4/4/4	-
4	PEG	L	404	-	-	2/4/4/4	-
2	GOL	J	401	-	-	1/4/4/4	-
2	GOL	N	404	-	-	2/4/4/4	-
4	PEG	G	404	-	-	3/4/4/4	-
2	GOL	D	403	-	-	2/4/4/4	-
2	GOL	N	403	-	-	2/4/4/4	-
2	GOL	B	404	-	-	0/4/4/4	-
2	GOL	B	405	-	-	4/4/4/4	-
2	GOL	A	401	-	-	1/4/4/4	-
2	GOL	I	401	-	-	4/4/4/4	-
2	GOL	K	403	-	-	2/4/4/4	-
2	GOL	M	401	-	-	0/4/4/4	-
2	GOL	C	403	-	-	2/4/4/4	-
2	GOL	M	402	-	-	2/4/4/4	-
2	GOL	D	402	-	-	3/4/4/4	-
2	GOL	G	402	-	-	0/4/4/4	-
4	PEG	J	403	-	-	4/4/4/4	-
2	GOL	K	402	-	-	2/4/4/4	-

*Continued on next page...*

*Continued from previous page...*

Mol	Type	Chain	Res	Link	Chirals	Torsions	Rings
4	PEG	C	404	-	-	2/4/4/4	-
2	GOL	G	401	-	-	4/4/4/4	-
2	GOL	F	403	-	-	2/4/4/4	-
2	GOL	L	402	-	-	4/4/4/4	-
2	GOL	K	401	-	-	3/4/4/4	-
2	GOL	A	402	-	-	2/4/4/4	-
2	GOL	J	402	-	-	0/4/4/4	-
2	GOL	N	402	-	-	2/4/4/4	-
3	EDO	L	405	-	-	1/1/1/1	-
2	GOL	L	401	-	-	2/4/4/4	-
2	GOL	N	401	-	-	2/4/4/4	-
2	GOL	E	403	-	-	2/4/4/4	-
2	GOL	C	402	-	-	2/4/4/4	-
2	GOL	E	402	-	-	4/4/4/4	-
2	GOL	B	401	-	-	2/4/4/4	-
3	EDO	K	404	-	-	1/1/1/1	-
2	GOL	I	402	-	-	2/4/4/4	-
2	GOL	B	403	-	-	0/4/4/4	-
3	EDO	A	403	-	-	1/1/1/1	-
2	GOL	O	401	-	-	2/4/4/4	-
2	GOL	M	403	-	-	2/4/4/4	-
2	GOL	C	401	-	-	2/4/4/4	-
2	GOL	E	401	-	-	2/4/4/4	-
2	GOL	B	402	-	-	1/4/4/4	-
2	GOL	P	401	-	-	2/4/4/4	-
2	GOL	D	404	-	-	2/4/4/4	-
2	GOL	F	402	-	-	2/4/4/4	-
3	EDO	I	403	-	-	0/1/1/1	-
2	GOL	D	401	-	-	3/4/4/4	-
3	EDO	C	405	-	-	1/1/1/1	-
2	GOL	G	403	-	-	3/4/4/4	-

There are no bond length outliers.

There are no bond angle outliers.

There are no chirality outliers.

All (104) torsion outliers are listed below:

Mol	Chain	Res	Type	Atoms
2	A	402	GOL	C1-C2-C3-O3
2	B	401	GOL	C1-C2-C3-O3
2	B	405	GOL	O1-C1-C2-C3
2	B	405	GOL	C1-C2-C3-O3
2	C	402	GOL	O1-C1-C2-C3
2	C	403	GOL	C1-C2-C3-O3
2	D	401	GOL	C1-C2-C3-O3
2	D	403	GOL	O1-C1-C2-C3
2	E	401	GOL	O1-C1-C2-C3
2	E	402	GOL	O1-C1-C2-C3
2	E	402	GOL	C1-C2-C3-O3
2	F	401	GOL	O1-C1-C2-C3
2	F	401	GOL	C1-C2-C3-O3
2	F	403	GOL	C1-C2-C3-O3
2	G	401	GOL	C1-C2-C3-O3
2	G	403	GOL	C1-C2-C3-O3
2	I	401	GOL	O1-C1-C2-C3
2	K	401	GOL	C1-C2-C3-O3
2	K	402	GOL	C1-C2-C3-O3
2	K	402	GOL	O2-C2-C3-O3
2	K	403	GOL	O1-C1-C2-O2
2	K	403	GOL	O1-C1-C2-C3
2	L	401	GOL	C1-C2-C3-O3
2	L	401	GOL	O2-C2-C3-O3
2	L	402	GOL	O1-C1-C2-C3
2	M	402	GOL	O1-C1-C2-C3
2	N	401	GOL	C1-C2-C3-O3
2	N	401	GOL	O2-C2-C3-O3
2	N	402	GOL	O1-C1-C2-C3
2	N	403	GOL	C1-C2-C3-O3
2	N	404	GOL	O1-C1-C2-C3
2	O	401	GOL	O1-C1-C2-C3
2	D	402	GOL	O2-C2-C3-O3
2	F	402	GOL	O1-C1-C2-O2
2	G	401	GOL	O2-C2-C3-O3
2	K	401	GOL	O2-C2-C3-O3
2	O	401	GOL	O1-C1-C2-O2
4	C	404	PEG	O1-C1-C2-O2
2	A	401	GOL	C1-C2-C3-O3
2	C	401	GOL	C1-C2-C3-O3
2	D	402	GOL	O1-C1-C2-C3
2	D	402	GOL	C1-C2-C3-O3
2	D	404	GOL	O1-C1-C2-C3

*Continued on next page...*

*Continued from previous page...*

Mol	Chain	Res	Type	Atoms
2	E	403	GOL	C1-C2-C3-O3
2	E	404	GOL	O1-C1-C2-C3
2	F	402	GOL	O1-C1-C2-C3
2	G	401	GOL	O1-C1-C2-C3
2	I	401	GOL	C1-C2-C3-O3
2	I	402	GOL	C1-C2-C3-O3
2	L	402	GOL	C1-C2-C3-O3
2	M	403	GOL	C1-C2-C3-O3
2	P	401	GOL	C1-C2-C3-O3
2	B	401	GOL	O2-C2-C3-O3
2	B	405	GOL	O1-C1-C2-O2
2	C	402	GOL	O1-C1-C2-O2
2	D	401	GOL	O2-C2-C3-O3
2	E	401	GOL	O1-C1-C2-O2
2	E	402	GOL	O1-C1-C2-O2
2	E	404	GOL	O1-C1-C2-O2
2	F	401	GOL	O1-C1-C2-O2
2	F	401	GOL	O2-C2-C3-O3
2	F	403	GOL	O2-C2-C3-O3
2	G	403	GOL	O2-C2-C3-O3
2	I	401	GOL	O1-C1-C2-O2
2	I	401	GOL	O2-C2-C3-O3
2	I	402	GOL	O2-C2-C3-O3
2	L	402	GOL	O1-C1-C2-O2
2	N	402	GOL	O1-C1-C2-O2
2	P	401	GOL	O2-C2-C3-O3
3	C	405	EDO	O1-C1-C2-O2
2	A	402	GOL	O2-C2-C3-O3
2	B	405	GOL	O2-C2-C3-O3
2	C	401	GOL	O2-C2-C3-O3
2	C	403	GOL	O2-C2-C3-O3
2	E	403	GOL	O2-C2-C3-O3
2	N	404	GOL	O1-C1-C2-O2
4	G	404	PEG	O2-C3-C4-O4
4	J	403	PEG	O1-C1-C2-O2
3	A	403	EDO	O1-C1-C2-O2
2	J	401	GOL	O1-C1-C2-C3
4	J	403	PEG	O2-C3-C4-O4
2	D	404	GOL	O1-C1-C2-O2
2	N	403	GOL	O2-C2-C3-O3
3	K	404	EDO	O1-C1-C2-O2
4	L	404	PEG	O2-C3-C4-O4

*Continued on next page...*

*Continued from previous page...*

Mol	Chain	Res	Type	Atoms
2	B	402	GOL	O2-C2-C3-O3
2	D	403	GOL	O1-C1-C2-O2
2	E	402	GOL	O2-C2-C3-O3
2	L	402	GOL	O2-C2-C3-O3
2	M	403	GOL	O2-C2-C3-O3
2	L	403	GOL	C1-C2-C3-O3
4	G	404	PEG	C4-C3-O2-C2
3	L	405	EDO	O1-C1-C2-O2
4	L	404	PEG	O1-C1-C2-O2
4	J	403	PEG	C1-C2-O2-C3
4	G	404	PEG	O1-C1-C2-O2
2	G	401	GOL	O1-C1-C2-O2
2	M	402	GOL	O1-C1-C2-O2
4	C	404	PEG	C4-C3-O2-C2
4	J	403	PEG	C4-C3-O2-C2
2	K	401	GOL	O1-C1-C2-C3
2	L	403	GOL	O2-C2-C3-O3
2	D	401	GOL	O1-C1-C2-C3
2	G	403	GOL	O1-C1-C2-C3

There are no ring outliers.

12 monomers are involved in 16 short contacts:

Mol	Chain	Res	Type	Clashes	Symm-Clashes
2	F	401	GOL	2	0
2	B	405	GOL	1	0
2	G	402	GOL	1	0
2	K	402	GOL	1	0
2	J	402	GOL	1	0
3	L	405	EDO	2	0
3	K	404	EDO	2	0
3	A	403	EDO	1	0
2	O	401	GOL	1	0
2	P	401	GOL	2	0
2	D	404	GOL	1	0
3	C	405	EDO	1	0

## 5.7 Other polymers [i](#)

There are no such residues in this entry.

## 5.8 Polymer linkage issues

There are no chain breaks in this entry.

## 6 Fit of model and data [i](#)

### 6.1 Protein, DNA and RNA chains [i](#)

In the following table, the column labelled ‘#RSRZ> 2’ contains the number (and percentage) of RSRZ outliers, followed by percent RSRZ outliers for the chain as percentile scores relative to all X-ray entries and entries of similar resolution. The OWAB column contains the minimum, median, 95<sup>th</sup> percentile and maximum values of the occupancy-weighted average B-factor per residue. The column labelled ‘Q< 0.9’ lists the number of (and percentage) of residues with an average occupancy less than 0.9.

Mol	Chain	Analysed	<RSRZ>	#RSRZ>2	OWAB(Å <sup>2</sup> )	Q<0.9
1	A	294/304 (96%)	0.07	19 (6%) 18 17	35, 57, 105, 133	0
1	B	297/304 (97%)	-0.33	1 (0%) 94 93	32, 45, 68, 113	0
1	C	301/304 (99%)	-0.31	0 100 100	30, 42, 62, 113	0
1	D	298/304 (98%)	-0.31	0 100 100	30, 42, 60, 99	0
1	E	297/304 (97%)	0.17	10 (3%) 45 44	31, 45, 65, 99	0
1	F	298/304 (98%)	0.29	11 (3%) 41 41	32, 57, 80, 108	0
1	G	295/304 (97%)	0.99	60 (20%) 1 0	60, 90, 113, 123	0
1	H	278/304 (91%)	2.42	156 (56%) 0 0	74, 118, 143, 162	0
1	I	293/304 (96%)	-0.03	11 (3%) 40 39	34, 48, 92, 132	0
1	J	298/304 (98%)	-0.26	3 (1%) 82 80	31, 42, 62, 121	0
1	K	301/304 (99%)	-0.22	2 (0%) 87 86	31, 45, 67, 118	0
1	L	298/304 (98%)	-0.31	1 (0%) 94 93	31, 42, 59, 98	0
1	M	297/304 (97%)	0.06	4 (1%) 77 75	31, 43, 62, 87	0
1	N	298/304 (98%)	-0.21	2 (0%) 87 86	32, 42, 60, 110	0
1	O	297/304 (97%)	0.19	10 (3%) 45 44	40, 61, 82, 119	0
1	P	288/304 (94%)	0.78	48 (16%) 1 1	43, 73, 117, 132	0
All	All	4728/4864 (97%)	0.18	338 (7%) 16 14	30, 49, 110, 162	0

All (338) RSRZ outliers are listed below:

Mol	Chain	Res	Type	RSRZ
1	H	58	ALA	12.9
1	H	29	ALA	8.7
1	H	111	ALA	8.1
1	I	301	LEU	8.0
1	H	300	VAL	7.0

*Continued on next page...*



*Continued from previous page...*

<b>Mol</b>	<b>Chain</b>	<b>Res</b>	<b>Type</b>	<b>RSRZ</b>
1	H	135	TYR	6.9
1	H	86	LEU	6.8
1	H	56	CYS	6.5
1	H	88	VAL	6.1
1	H	134	PHE	6.1
1	H	224	ILE	6.0
1	H	130	TYR	5.8
1	H	57	GLN	5.8
1	H	234	ILE	5.7
1	H	38	LYS	5.6
1	H	13	ALA	5.6
1	H	221	GLY	5.5
1	H	102	HIS	5.5
1	H	40	GLY	5.5
1	H	83	ALA	5.5
1	H	99	ASN	5.5
1	H	109	ILE	5.5
1	G	89	VAL	5.4
1	P	63	PHE	5.4
1	H	54	TYR	5.4
1	A	193	ILE	5.4
1	H	185	GLY	5.3
1	G	88	VAL	5.3
1	J	4	ASP	5.3
1	H	33	VAL	5.3
1	H	82	LEU	5.2
1	H	103	TYR	5.2
1	H	137	ASN	5.1
1	H	10	VAL	5.1
1	H	225	ILE	5.1
1	H	256	LYS	5.0
1	H	41	ALA	5.0
1	H	55	PHE	5.0
1	P	232	SER	4.9
1	I	229	HIS	4.9
1	A	127	GLY	4.9
1	P	4	ASP	4.9
1	A	301	LEU	4.9
1	H	85	GLU	4.9
1	P	224	ILE	4.8
1	P	126	ASP	4.8
1	A	130	TYR	4.8

*Continued on next page...*

*Continued from previous page...*

Mol	Chain	Res	Type	RSRZ
1	H	236	PHE	4.7
1	H	36	ALA	4.7
1	H	59	GLN	4.7
1	H	76	ILE	4.7
1	H	223	GLU	4.7
1	H	17	ALA	4.7
1	A	57	GLN	4.7
1	H	95	PHE	4.6
1	H	93	SER	4.6
1	G	107	ALA	4.5
1	H	237	TYR	4.5
1	H	77	MET	4.5
1	H	44	VAL	4.5
1	I	230	GLY	4.4
1	G	7	ARG	4.4
1	H	75	THR	4.4
1	H	87	GLY	4.4
1	G	276	CYS	4.4
1	H	24	THR	4.4
1	H	159	TRP	4.4
1	O	5	LYS	4.4
1	G	26	VAL	4.3
1	H	118	ILE	4.3
1	A	229	HIS	4.3
1	P	231	LYS	4.3
1	G	81	LYS	4.3
1	P	130	TYR	4.3
1	F	279	VAL	4.3
1	O	6	GLY	4.2
1	H	78	ARG	4.2
1	G	27	THR	4.2
1	G	53	TYR	4.2
1	H	70	TYR	4.2
1	H	222	ASN	4.1
1	H	98	ALA	4.1
1	H	150	TYR	4.1
1	P	54	TYR	4.1
1	P	127	GLY	4.0
1	A	192	SER	4.0
1	G	110	ASP	3.9
1	H	39	GLN	3.9
1	H	16	PHE	3.9

*Continued on next page...*

*Continued from previous page...*

<b>Mol</b>	<b>Chain</b>	<b>Res</b>	<b>Type</b>	<b>RSRZ</b>
1	H	49	LEU	3.9
1	H	94	PHE	3.9
1	H	113	GLY	3.9
1	H	53	TYR	3.9
1	G	277	TRP	3.8
1	H	257	GLU	3.8
1	H	155	VAL	3.8
1	H	81	LYS	3.8
1	H	112	ASP	3.8
1	G	151	ALA	3.8
1	H	11	VAL	3.7
1	H	6	GLY	3.7
1	H	119	TYR	3.7
1	H	108	ILE	3.7
1	H	263	ALA	3.7
1	O	114	THR	3.7
1	H	72	ASP	3.7
1	H	253	ALA	3.7
1	G	70	TYR	3.7
1	P	188	PRO	3.6
1	H	21	ASP	3.6
1	H	61	GLU	3.6
1	P	59	GLN	3.6
1	H	43	ILE	3.6
1	P	193	ILE	3.6
1	P	227	THR	3.6
1	H	9	VAL	3.6
1	P	134	PHE	3.5
1	G	273	MET	3.5
1	P	100	ASN	3.5
1	H	136	PHE	3.5
1	H	42	ASN	3.5
1	P	58	ALA	3.5
1	G	10	VAL	3.4
1	H	20	ASP	3.4
1	H	101	ALA	3.4
1	H	194	ASP	3.4
1	I	228	GLU	3.4
1	H	47	GLN	3.4
1	H	19	THR	3.4
1	P	225	ILE	3.4
1	H	37	HIS	3.4

*Continued on next page...*

*Continued from previous page...*

<b>Mol</b>	<b>Chain</b>	<b>Res</b>	<b>Type</b>	<b>RSRZ</b>
1	O	276	CYS	3.4
1	P	57	GLN	3.3
1	H	100	ASN	3.3
1	G	9	VAL	3.3
1	H	262	ILE	3.3
1	H	68	LYS	3.3
1	A	230	GLY	3.3
1	H	64	ILE	3.3
1	P	186	SER	3.2
1	H	84	LYS	3.2
1	I	130	TYR	3.2
1	H	114	THR	3.2
1	G	29	ALA	3.2
1	G	114	THR	3.2
1	P	111	ALA	3.2
1	G	80	GLN	3.2
1	G	76	ILE	3.2
1	G	38	LYS	3.2
1	H	14	LEU	3.2
1	H	148	THR	3.1
1	G	24	THR	3.1
1	H	12	SER	3.1
1	H	296	GLY	3.1
1	K	3	GLU	3.1
1	H	65	GLN	3.1
1	G	270	ILE	3.1
1	I	4	ASP	3.1
1	H	71	LYS	3.1
1	G	44	VAL	3.1
1	H	297	LYS	3.1
1	H	89	VAL	3.1
1	I	279	VAL	3.1
1	G	77	MET	3.1
1	G	84	LYS	3.1
1	P	36	ALA	3.1
1	H	92	VAL	3.0
1	P	226	GLU	3.0
1	H	180	TYR	3.0
1	H	139	GLY	3.0
1	H	32	LEU	3.0
1	G	259	ALA	3.0
1	H	226	GLU	3.0

*Continued on next page...*

*Continued from previous page...*

<b>Mol</b>	<b>Chain</b>	<b>Res</b>	<b>Type</b>	<b>RSRZ</b>
1	G	171	ALA	3.0
1	P	99	ASN	3.0
1	H	7	ARG	2.9
1	H	158	SER	2.9
1	P	56	CYS	2.9
1	G	109	ILE	2.9
1	G	16	PHE	2.9
1	P	220	ILE	2.9
1	G	11	VAL	2.9
1	H	18	CYS	2.9
1	H	67	ALA	2.9
1	H	255	ASP	2.9
1	H	124	ILE	2.8
1	E	163	PHE	2.8
1	H	254	ASP	2.8
1	P	60	ARG	2.8
1	A	231	LYS	2.8
1	A	299	PRO	2.8
1	H	74	PRO	2.8
1	E	124	ILE	2.8
1	H	35	ALA	2.8
1	P	98	ALA	2.8
1	H	122	SER	2.8
1	H	151	ALA	2.8
1	H	91	PRO	2.8
1	I	128	PRO	2.8
1	H	116	LEU	2.8
1	B	6	GLY	2.7
1	H	235	LYS	2.7
1	G	118	ILE	2.7
1	A	128	PRO	2.7
1	A	226	GLU	2.7
1	H	215	VAL	2.7
1	O	88	VAL	2.7
1	H	115	ASP	2.7
1	F	29	ALA	2.7
1	H	97	GLU	2.7
1	H	107	ALA	2.7
1	G	224	ILE	2.6
1	F	163	PHE	2.6
1	H	45	LEU	2.6
1	P	53	TYR	2.6

*Continued on next page...*

*Continued from previous page...*

<b>Mol</b>	<b>Chain</b>	<b>Res</b>	<b>Type</b>	<b>RSRZ</b>
1	P	5	LYS	2.6
1	I	278	GLY	2.6
1	H	298	ASN	2.6
1	P	222	ASN	2.6
1	G	146	PHE	2.6
1	F	41	ALA	2.6
1	G	72	ASP	2.6
1	P	18	CYS	2.5
1	P	137	ASN	2.5
1	H	279	VAL	2.5
1	H	156	ALA	2.5
1	H	184	ILE	2.5
1	A	228	GLU	2.5
1	H	149	LYS	2.5
1	E	86	LEU	2.5
1	J	5	LYS	2.5
1	G	148	THR	2.5
1	H	238	GLY	2.5
1	H	294	LEU	2.5
1	E	279	VAL	2.5
1	H	299	PRO	2.5
1	P	135	TYR	2.5
1	L	4	ASP	2.5
1	H	63	PHE	2.4
1	P	62	ASP	2.4
1	A	188	PRO	2.4
1	H	8	LYS	2.4
1	G	153	ILE	2.4
1	G	266	ASN	2.4
1	F	260	VAL	2.4
1	G	21	ASP	2.4
1	P	300	VAL	2.4
1	P	234	ILE	2.4
1	P	114	THR	2.4
1	H	157	ILE	2.4
1	G	115	ASP	2.4
1	P	41	ALA	2.4
1	P	83	ALA	2.4
1	F	4	ASP	2.3
1	P	61	GLU	2.3
1	H	27	THR	2.3
1	H	186	SER	2.3

*Continued on next page...*

*Continued from previous page...*

Mol	Chain	Res	Type	RSRZ
1	N	4	ASP	2.3
1	H	106	ILE	2.3
1	H	125	PRO	2.3
1	G	19	THR	2.3
1	H	117	GLY	2.3
1	G	90	ILE	2.3
1	E	294	LEU	2.3
1	G	267	LEU	2.3
1	H	295	ASP	2.3
1	F	5	LYS	2.3
1	A	129	GLY	2.3
1	G	279	VAL	2.3
1	H	260	VAL	2.3
1	P	233	GLU	2.3
1	M	56	CYS	2.3
1	H	198	HIS	2.3
1	F	134	PHE	2.3
1	G	111	ALA	2.3
1	H	46	ILE	2.3
1	G	30	GLU	2.2
1	G	278	GLY	2.2
1	G	147	GLN	2.2
1	H	80	GLN	2.2
1	H	60	ARG	2.2
1	O	90	ILE	2.2
1	J	162	TRP	2.2
1	O	81	LYS	2.2
1	A	100	ASN	2.2
1	I	276[A]	CYS	2.2
1	G	106	ILE	2.2
1	G	71	LYS	2.2
1	P	133	LYS	2.2
1	H	22	VAL	2.2
1	H	120	ARG	2.2
1	E	162	TRP	2.2
1	M	164	PRO	2.2
1	G	150	TYR	2.1
1	P	70	TYR	2.1
1	A	280	PHE	2.1
1	G	116	LEU	2.1
1	E	164	PRO	2.1
1	H	140	ASP	2.1

*Continued on next page...*

*Continued from previous page...*

<b>Mol</b>	<b>Chain</b>	<b>Res</b>	<b>Type</b>	<b>RSRZ</b>
1	G	301	LEU	2.1
1	O	159	TRP	2.1
1	O	84	LYS	2.1
1	K	4	ASP	2.1
1	P	55	PHE	2.1
1	H	31	ARG	2.1
1	F	278	GLY	2.1
1	O	77	MET	2.1
1	G	268	ASP	2.1
1	P	88	VAL	2.1
1	H	278	GLY	2.1
1	F	82	LEU	2.1
1	G	8	LYS	2.1
1	G	82	LEU	2.1
1	G	271	LYS	2.1
1	G	37	HIS	2.1
1	H	110	ASP	2.1
1	H	132	GLU	2.1
1	H	264	GLU	2.1
1	H	179	PHE	2.1
1	H	138	PRO	2.1
1	H	62	ASP	2.1
1	A	227	THR	2.1
1	M	124	ILE	2.0
1	E	83	ALA	2.0
1	G	226	GLU	2.0
1	I	277	TRP	2.0
1	M	279	VAL	2.0
1	N	279	VAL	2.0
1	G	86	LEU	2.0
1	F	114	THR	2.0
1	E	166	ALA	2.0
1	H	66	ARG	2.0
1	P	138	PRO	2.0
1	A	279	VAL	2.0
1	E	291	LEU	2.0
1	H	79	LEU	2.0
1	P	131	GLU	2.0
1	P	21	ASP	2.0



## 6.2 Non-standard residues in protein, DNA, RNA chains [i](#)

There are no non-standard protein/DNA/RNA residues in this entry.

## 6.3 Carbohydrates [i](#)

There are no monosaccharides in this entry.

## 6.4 Ligands [i](#)

In the following table, the Atoms column lists the number of modelled atoms in the group and the number defined in the chemical component dictionary. The B-factors column lists the minimum, median, 95<sup>th</sup> percentile and maximum values of B factors of atoms in the group. The column labelled 'Q< 0.9' lists the number of atoms with occupancy less than 0.9.

Mol	Type	Chain	Res	Atoms	RSCC	RSR	B-factors(Å <sup>2</sup> )	Q<0.9
2	GOL	B	405	6/6	0.65	0.45	62,68,87,87	0
2	GOL	E	404	6/6	0.70	0.48	73,85,99,100	0
2	GOL	N	404	6/6	0.79	0.35	65,76,82,89	0
4	PEG	J	403	7/7	0.80	0.38	74,97,101,102	0
4	PEG	G	404	7/7	0.81	0.21	73,89,99,102	0
2	GOL	D	404	6/6	0.84	0.28	50,65,73,85	0
4	PEG	C	404	7/7	0.87	0.33	68,102,116,120	0
2	GOL	F	401	6/6	0.88	0.26	71,74,76,77	0
2	GOL	J	402	6/6	0.89	0.29	63,67,79,92	0
2	GOL	N	401	6/6	0.89	0.29	57,60,64,66	0
2	GOL	G	402	6/6	0.89	0.21	75,82,95,100	0
4	PEG	L	404	7/7	0.89	0.51	68,75,98,100	0
2	GOL	A	401	6/6	0.90	0.19	68,79,90,90	0
2	GOL	E	402	6/6	0.90	0.18	63,66,76,78	0
2	GOL	M	401	6/6	0.90	0.31	50,54,56,59	0
2	GOL	B	404	6/6	0.91	0.15	61,68,71,74	0
2	GOL	O	401	6/6	0.91	0.34	62,67,69,70	0
3	EDO	K	404	4/4	0.91	0.42	68,70,73,73	0
2	GOL	C	403	6/6	0.91	0.19	49,57,66,67	0
2	GOL	K	403	6/6	0.91	0.28	57,67,74,77	0
2	GOL	F	403	6/6	0.91	0.35	62,77,82,89	0
2	GOL	G	401	6/6	0.91	0.34	76,78,79,81	0
3	EDO	C	405	4/4	0.92	0.31	65,69,71,79	0
2	GOL	G	403	6/6	0.92	0.32	61,73,84,85	0
2	GOL	B	403	6/6	0.92	0.14	52,72,79,85	0
2	GOL	N	402	6/6	0.92	0.18	47,74,97,98	0
2	GOL	K	401	6/6	0.92	0.16	49,52,55,56	0

*Continued on next page...*

*Continued from previous page...*

Mol	Type	Chain	Res	Atoms	RSCC	RSR	B-factors( $\text{\AA}^2$ )	Q<0.9
2	GOL	E	401	6/6	0.92	0.36	49,52,55,55	0
2	GOL	C	401	6/6	0.93	0.18	46,49,51,54	0
2	GOL	J	401	6/6	0.93	0.29	49,53,53,54	0
3	EDO	D	405	4/4	0.93	0.22	60,65,72,76	0
2	GOL	B	401	6/6	0.93	0.24	49,52,55,55	0
2	GOL	M	403	6/6	0.94	0.22	53,62,70,72	0
2	GOL	D	402	6/6	0.94	0.19	53,57,87,89	0
2	GOL	I	401	6/6	0.94	0.23	48,55,67,79	0
2	GOL	I	402	6/6	0.94	0.10	61,68,75,76	0
2	GOL	L	401	6/6	0.94	0.34	51,60,62,73	0
2	GOL	D	403	6/6	0.94	0.30	54,61,67,70	0
2	GOL	N	403	6/6	0.95	0.20	49,61,64,72	0
2	GOL	E	403	6/6	0.95	0.25	56,59,65,66	0
3	EDO	L	405	4/4	0.95	0.19	52,67,69,71	0
2	GOL	D	401	6/6	0.95	0.22	49,51,54,63	0
2	GOL	P	401	6/6	0.95	0.12	53,63,66,68	0
3	EDO	A	403	4/4	0.95	0.26	64,64,67,74	0
2	GOL	A	402	6/6	0.95	0.13	55,65,69,72	0
2	GOL	L	402	6/6	0.96	0.19	62,68,83,91	0
2	GOL	F	402	6/6	0.96	0.20	54,66,78,84	0
3	EDO	I	403	4/4	0.96	0.27	58,62,66,77	0
2	GOL	K	402	6/6	0.97	0.16	52,59,81,84	0
2	GOL	B	402	6/6	0.97	0.16	44,60,65,85	0
2	GOL	M	402	6/6	0.97	0.13	52,61,68,85	0
2	GOL	C	402	6/6	0.97	0.18	52,58,85,90	0
2	GOL	L	403	6/6	0.98	0.34	49,67,71,73	0

## 6.5 Other polymers [\(i\)](#)

There are no such residues in this entry.