



Full wwPDB X-ray Structure Validation Report ⓘ

Sep 18, 2023 – 10:11 PM EDT

PDB ID : 5BW9
Title : Crystal Structure of Yeast V1-ATPase in the Autoinhibited Form
Authors : Oot, R.A.; Kane, P.M.; Berry, E.A.; Wilkens, S.
Deposited on : 2015-06-06
Resolution : 7.00 Å(reported)

This is a Full wwPDB X-ray Structure Validation Report for a publicly released PDB entry.

We welcome your comments at validation@mail.wwpdb.org

A user guide is available at

<https://www.wwpdb.org/validation/2017/XrayValidationReportHelp>

with specific help available everywhere you see the ⓘ symbol.

The types of validation reports are described at

<http://www.wwpdb.org/validation/2017/FAQs#types>.

The following versions of software and data (see [references ⓘ](#)) were used in the production of this report:

MolProbity : 4.02b-467
Xtriage (Phenix) : 1.13
EDS : 2.35.1
Percentile statistics : 20191225.v01 (using entries in the PDB archive December 25th 2019)
Refmac : 5.8.0158
CCP4 : 7.0.044 (Gargrove)
Ideal geometry (proteins) : Engh & Huber (2001)
Ideal geometry (DNA, RNA) : Parkinson et al. (1996)
Validation Pipeline (wwPDB-VP) : 2.35.1

1 Overall quality at a glance

The following experimental techniques were used to determine the structure:

X-RAY DIFFRACTION

The reported resolution of this entry is 7.00 Å.

Percentile scores (ranging between 0-100) for global validation metrics of the entry are shown in the following graphic. The table shows the number of entries on which the scores are based.

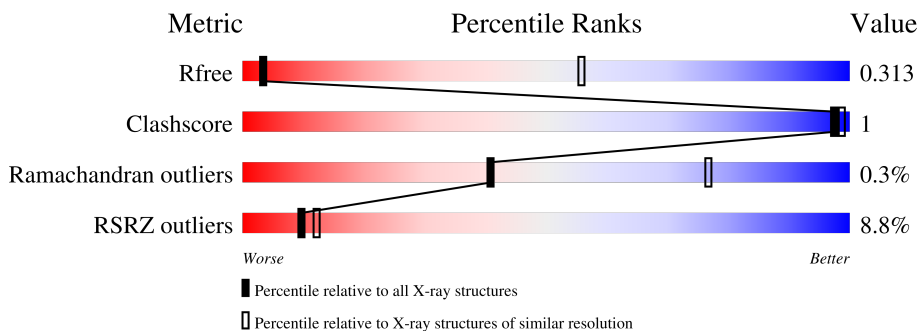

Metric	Whole archive (#Entries)	Similar resolution (#Entries, resolution range(Å))
R_{free}	130704	1004 (10.00-3.90)
Clashscore	141614	1069 (10.00-3.90)
Ramachandran outliers	138981	1002 (10.00-3.90)
RSRZ outliers	127900	1004 (9.50-3.80)

The table below summarises the geometric issues observed across the polymeric chains and their fit to the electron density. The red, orange, yellow and green segments of the lower bar indicate the fraction of residues that contain outliers for ≥ 3 , 2, 1 and 0 types of geometric quality criteria respectively. A grey segment represents the fraction of residues that are not modelled. The numeric value for each fraction is indicated below the corresponding segment, with a dot representing fractions $\leq 5\%$. The upper red bar (where present) indicates the fraction of residues that have poor fit to the electron density. The numeric value is given above the bar.

Mol	Chain	Length	Quality of chain
1	A	617	 15% 92%
1	B	617	 11% 93%
1	C	617	 10% 93% 5%
1	a	617	 17% 95%
1	b	617	 10% 95% 5%
1	c	617	 8% 94% 5%

Continued on next page...

Continued from previous page...

Mol	Chain	Length	Quality of chain
2	D	517	86% 12%
2	E	517	85% 12%
2	F	517	84% 13%
2	d	517	89% 11%
2	e	517	88% 12%
2	f	517	87% 13%
3	H	478	92% 7%
3	h	478	93% 7%
4	G	256	54% 46%
4	g	256	55% 45%
5	J	122	85% 15%
5	L	122	56% 44%
5	N	122	66% 34%
5	j	122	83% 17%
5	l	122	54% 46%
5	n	122	48% 52%
6	I	233	93% 7%
6	K	233	76% 24%
6	M	233	86% 13%
6	i	233	93% 7%
6	k	233	72% 28%
6	m	233	78% 22%

2 Entry composition

There are 6 unique types of molecules in this entry. The entry contains 44760 atoms, of which 0 are hydrogens and 0 are deuteriums.

In the tables below, the ZeroOcc column contains the number of atoms modelled with zero occupancy, the AltConf column contains the number of residues with at least one atom in alternate conformation and the Trace column contains the number of residues modelled with at most 2 atoms.

- Molecule 1 is a protein called V-type proton ATPase catalytic subunit A.

Mol	Chain	Residues	Atoms				ZeroOcc	AltConf	Trace
			Total	C	N	O			
1	A	591	2905	1723	591	591	0	0	0
1	B	594	2920	1732	594	594	0	0	0
1	C	589	2895	1717	589	589	0	0	0
1	a	591	2905	1723	591	591	0	0	0
1	b	589	2895	1717	589	589	0	0	0
1	c	586	2880	1708	586	586	0	0	0

- Molecule 2 is a protein called V-type proton ATPase subunit B.

Mol	Chain	Residues	Atoms				ZeroOcc	AltConf	Trace
			Total	C	N	O			
2	D	457	2250	1336	457	457	0	0	0
2	E	453	2231	1325	453	453	0	0	0
2	F	449	2211	1313	449	449	0	0	0
2	d	460	2265	1345	460	460	0	0	0
2	e	456	2245	1333	456	456	0	0	0
2	f	449	2212	1314	449	449	0	0	0

- Molecule 3 is a protein called V-type proton ATPase subunit H.

Mol	Chain	Residues	Atoms				ZeroOcc	AltConf	Trace
			Total	C	N	O			
3	H	445	2212	1322	445	445	0	0	0
3	h	444	2208	1320	444	444	0	0	0

- Molecule 4 is a protein called V-type proton ATPase subunit D.

Mol	Chain	Residues	Atoms				ZeroOcc	AltConf	Trace
			Total	C	N	O			
4	G	139	691	413	139	139	0	0	0
4	g	141	701	419	141	141	0	0	0

- Molecule 5 is a protein called V-type proton ATPase subunit G.

Mol	Chain	Residues	Atoms				ZeroOcc	AltConf	Trace
			Total	C	N	O			
5	J	104	514	306	104	104	0	0	0
5	L	68	335	199	68	68	0	0	0
5	N	81	400	238	81	81	0	0	0
5	j	101	499	297	101	101	0	0	0
5	l	66	325	193	66	66	0	0	0
5	n	58	288	172	58	58	0	0	0

There are 54 discrepancies between the modelled and reference sequences:

Chain	Residue	Modelled	Actual	Comment	Reference
J	-7	MET	-	initiating methionine	UNP P48836
J	-6	ASP	-	expression tag	UNP P48836
J	-5	TYR	-	expression tag	UNP P48836
J	-4	LYS	-	expression tag	UNP P48836
J	-3	ASP	-	expression tag	UNP P48836
J	-2	ASP	-	expression tag	UNP P48836
J	-1	ASP	-	expression tag	UNP P48836
J	0	ASP	-	expression tag	UNP P48836
J	1	LYS	-	expression tag	UNP P48836
L	-7	MET	-	initiating methionine	UNP P48836
L	-6	ASP	-	expression tag	UNP P48836

Continued on next page...

Continued from previous page...

Chain	Residue	Modelled	Actual	Comment	Reference
L	-5	TYR	-	expression tag	UNP P48836
L	-4	LYS	-	expression tag	UNP P48836
L	-3	ASP	-	expression tag	UNP P48836
L	-2	ASP	-	expression tag	UNP P48836
L	-1	ASP	-	expression tag	UNP P48836
L	0	ASP	-	expression tag	UNP P48836
L	1	LYS	-	expression tag	UNP P48836
N	-7	MET	-	initiating methionine	UNP P48836
N	-6	ASP	-	expression tag	UNP P48836
N	-5	TYR	-	expression tag	UNP P48836
N	-4	LYS	-	expression tag	UNP P48836
N	-3	ASP	-	expression tag	UNP P48836
N	-2	ASP	-	expression tag	UNP P48836
N	-1	ASP	-	expression tag	UNP P48836
N	0	ASP	-	expression tag	UNP P48836
N	1	LYS	-	expression tag	UNP P48836
j	-7	MET	-	initiating methionine	UNP P48836
j	-6	ASP	-	expression tag	UNP P48836
j	-5	TYR	-	expression tag	UNP P48836
j	-4	LYS	-	expression tag	UNP P48836
j	-3	ASP	-	expression tag	UNP P48836
j	-2	ASP	-	expression tag	UNP P48836
j	-1	ASP	-	expression tag	UNP P48836
j	0	ASP	-	expression tag	UNP P48836
j	1	LYS	-	expression tag	UNP P48836
l	-7	MET	-	initiating methionine	UNP P48836
l	-6	ASP	-	expression tag	UNP P48836
l	-5	TYR	-	expression tag	UNP P48836
l	-4	LYS	-	expression tag	UNP P48836
l	-3	ASP	-	expression tag	UNP P48836
l	-2	ASP	-	expression tag	UNP P48836
l	-1	ASP	-	expression tag	UNP P48836
l	0	ASP	-	expression tag	UNP P48836
l	1	LYS	-	expression tag	UNP P48836
n	-7	MET	-	initiating methionine	UNP P48836
n	-6	ASP	-	expression tag	UNP P48836
n	-5	TYR	-	expression tag	UNP P48836
n	-4	LYS	-	expression tag	UNP P48836
n	-3	ASP	-	expression tag	UNP P48836
n	-2	ASP	-	expression tag	UNP P48836
n	-1	ASP	-	expression tag	UNP P48836
n	0	ASP	-	expression tag	UNP P48836

Continued on next page...

Continued from previous page...

Chain	Residue	Modelled	Actual	Comment	Reference
n	1	LYS	-	expression tag	UNP P48836

- Molecule 6 is a protein called V-type proton ATPase subunit E.

Mol	Chain	Residues	Atoms				ZeroOcc	AltConf	Trace
6	I	216	Total	C	N	O	0	0	0
			1073	641	216	216			
6	K	178	Total	C	N	O	0	0	0
			883	527	178	178			
6	M	203	Total	C	N	O	0	0	0
			1008	602	203	203			
6	i	217	Total	C	N	O	0	0	0
			1078	644	217	217			
6	k	168	Total	C	N	O	0	0	0
			833	497	168	168			
6	m	181	Total	C	N	O	0	0	0
			898	536	181	181			

3 Residue-property plots [i](#)

These plots are drawn for all protein, RNA, DNA and oligosaccharide chains in the entry. The first graphic for a chain summarises the proportions of the various outlier classes displayed in the second graphic. The second graphic shows the sequence view annotated by issues in geometry and electron density. Residues are color-coded according to the number of geometric quality criteria for which they contain at least one outlier: green = 0, yellow = 1, orange = 2 and red = 3 or more. A red dot above a residue indicates a poor fit to the electron density ($RSRZ > 2$). Stretches of 2 or more consecutive residues without any outlier are shown as a green connector. Residues present in the sample, but not in the model, are shown in grey.

- Molecule 1: V-type proton ATPase catalytic subunit A

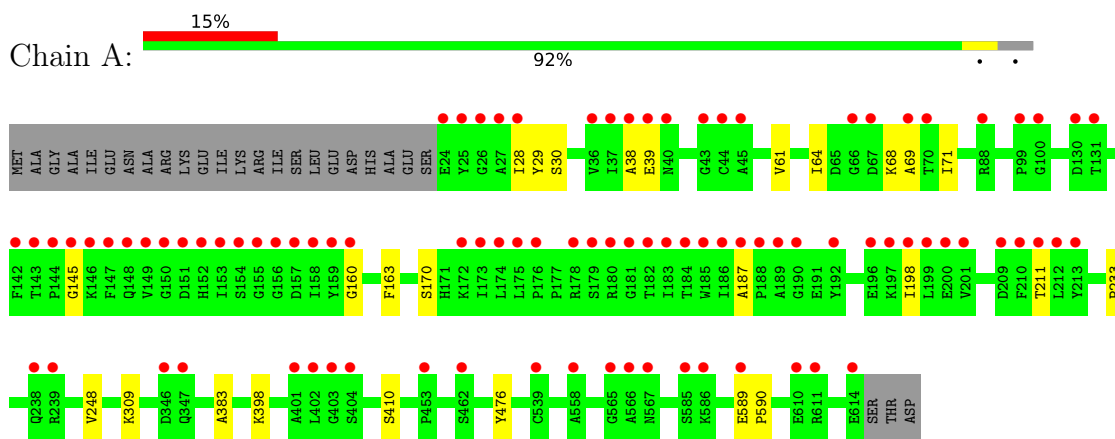

- Molecule 1: V-type proton ATPase catalytic subunit A

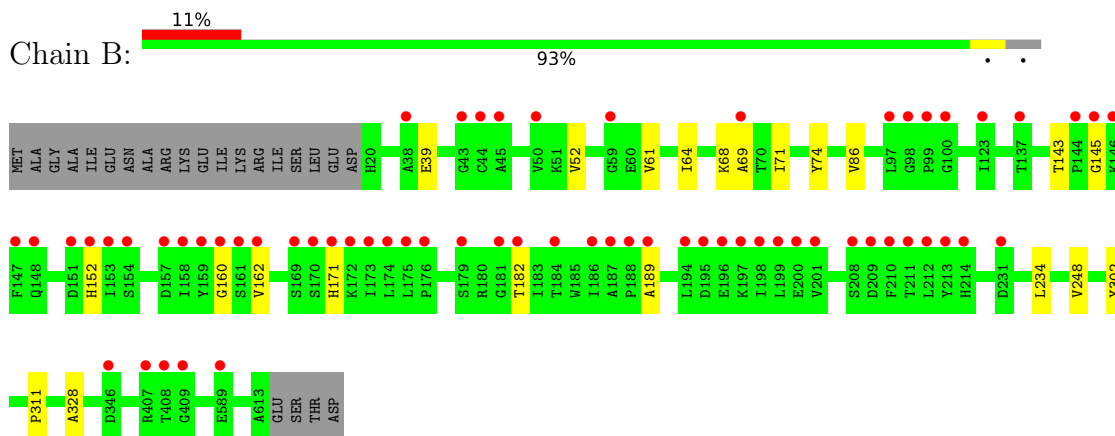

- Molecule 1: V-type proton ATPase catalytic subunit A

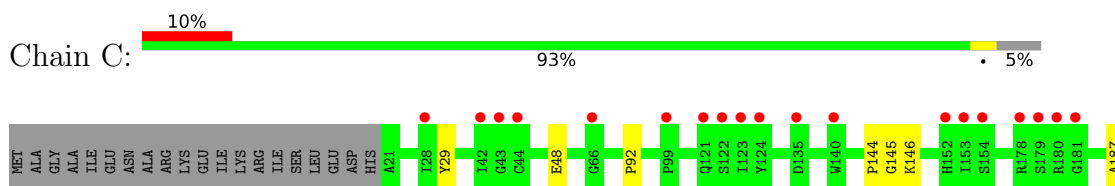

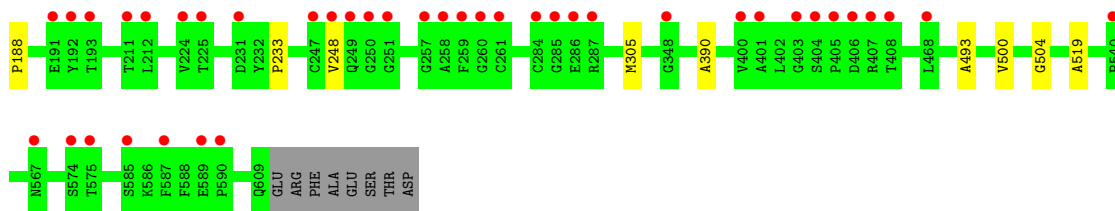

- Molecule 1: V-type proton ATPase catalytic subunit A

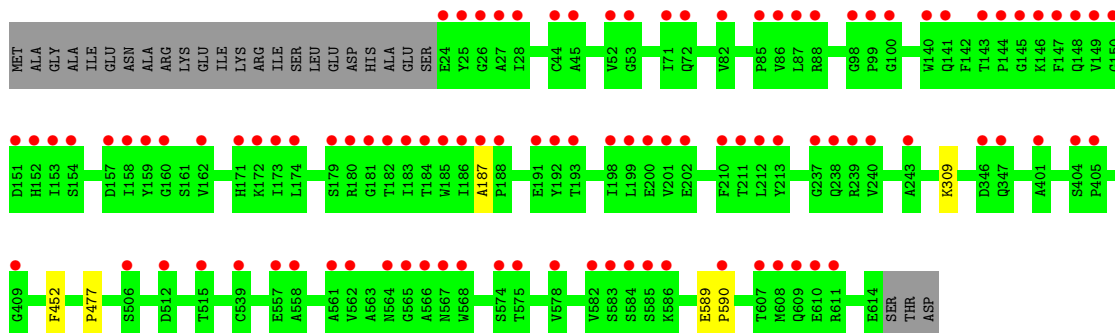

- Molecule 1: V-type proton ATPase catalytic subunit A

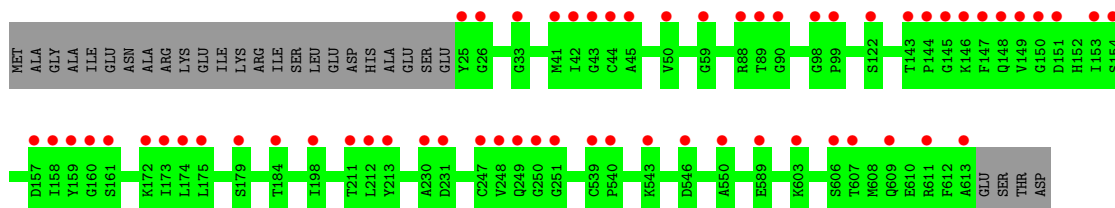

- Molecule 1: V-type proton ATPase catalytic subunit A

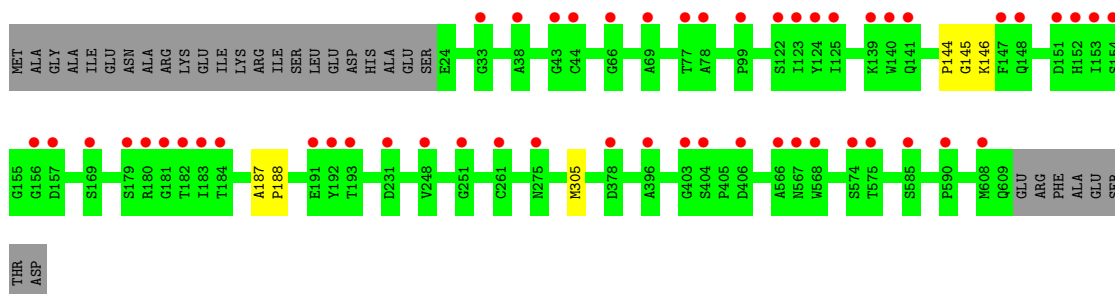
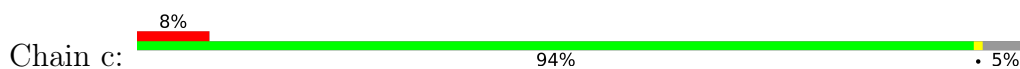

- Molecule 2: V-type proton ATPase subunit B

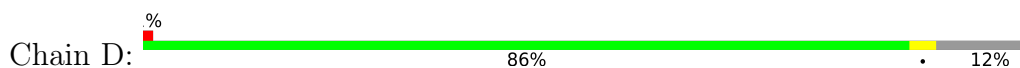

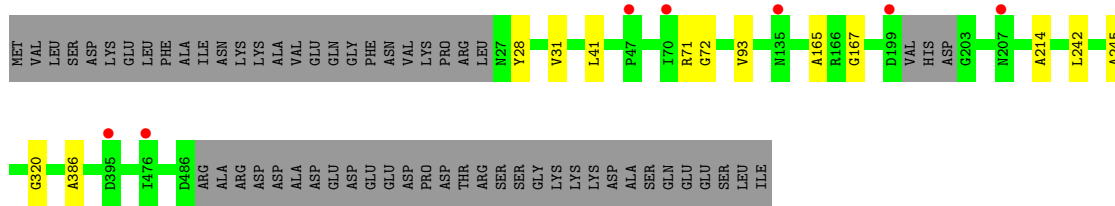

• Molecule 2: V-type proton ATPase subunit B

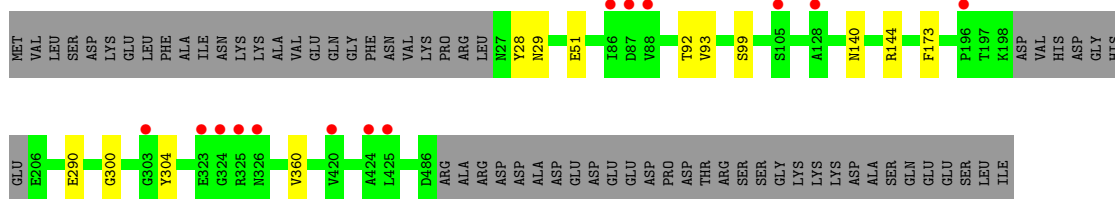
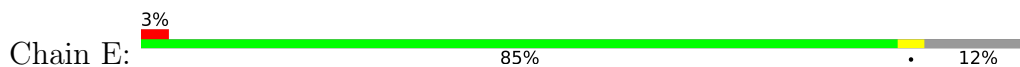

• Molecule 2: V-type proton ATPase subunit B

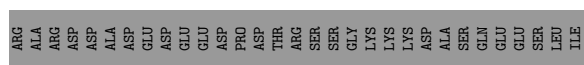
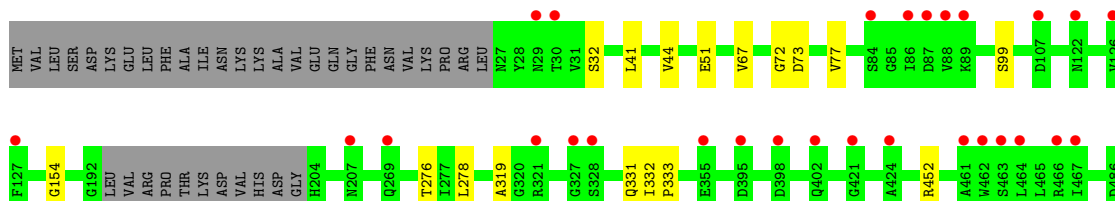
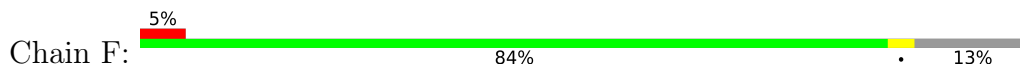

• Molecule 2: V-type proton ATPase subunit B

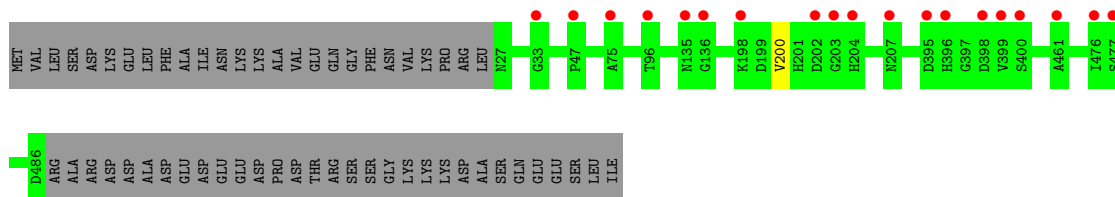
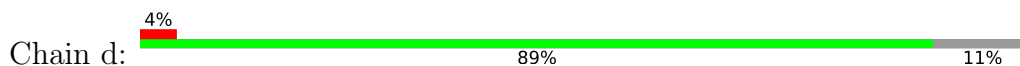

• Molecule 2: V-type proton ATPase subunit B

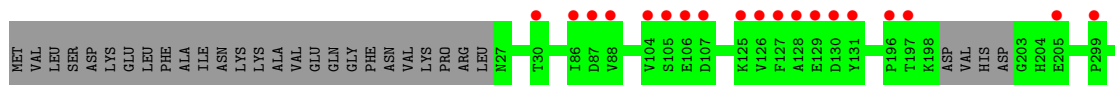
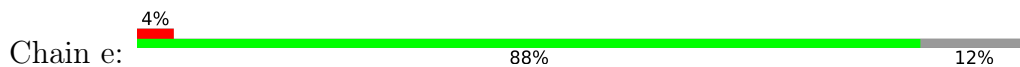

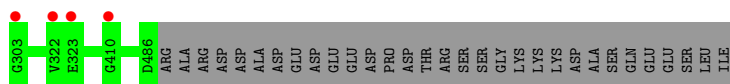

- Molecule 2: V-type proton ATPase subunit B

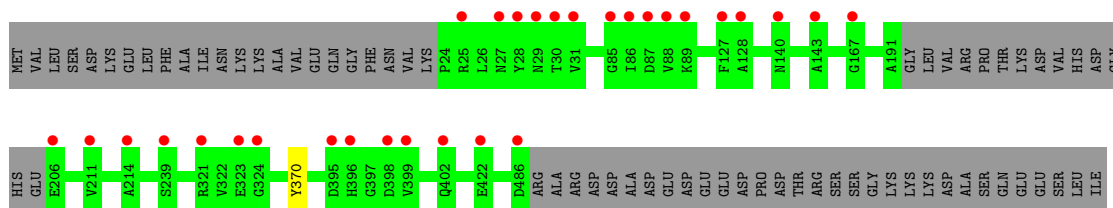
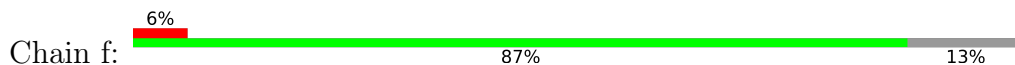

- Molecule 3: V-type proton ATPase subunit H

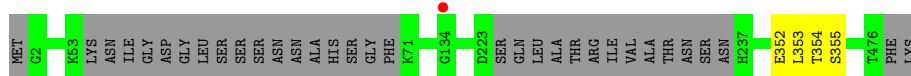

- Molecule 3: V-type proton ATPase subunit H

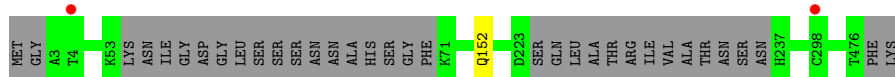

- Molecule 4: V-type proton ATPase subunit D

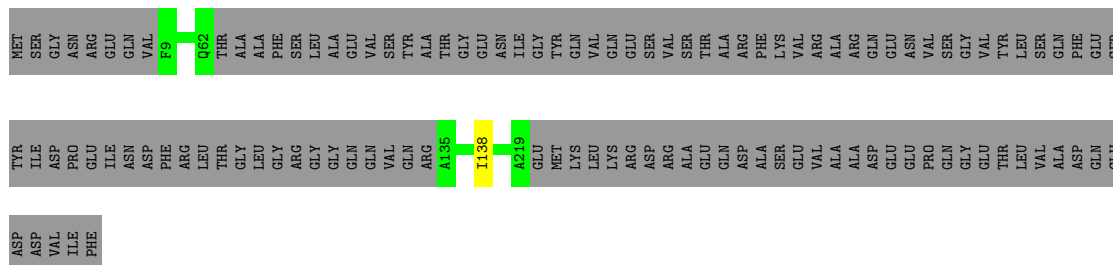

- Molecule 4: V-type proton ATPase subunit D

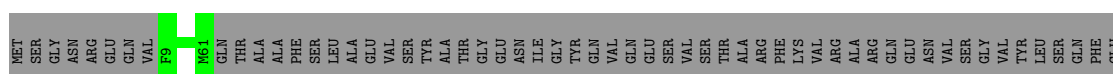



PHE

- Molecule 5: V-type proton ATPase subunit G

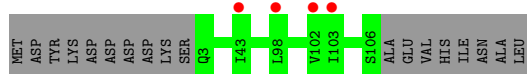
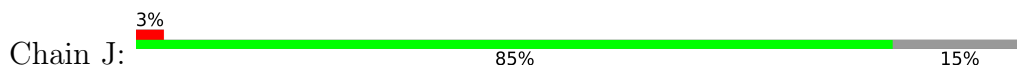

- Molecule 5: V-type proton ATPase subunit G

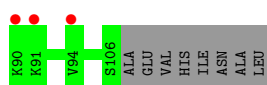
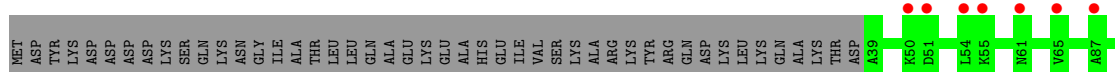

- Molecule 5: V-type proton ATPase subunit G

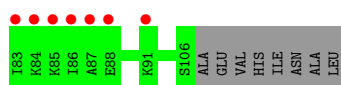
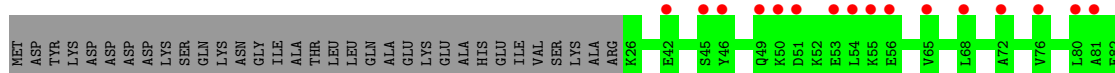

- Molecule 5: V-type proton ATPase subunit G

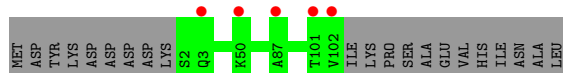
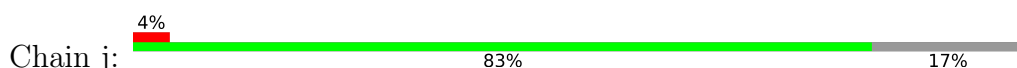

- Molecule 5: V-type proton ATPase subunit G

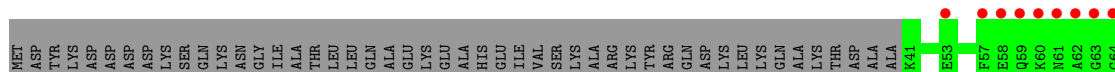

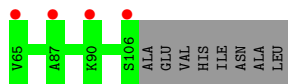

• Molecule 5: V-type proton ATPase subunit G

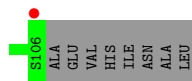
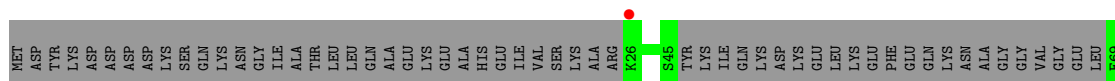

• Molecule 6: V-type proton ATPase subunit E

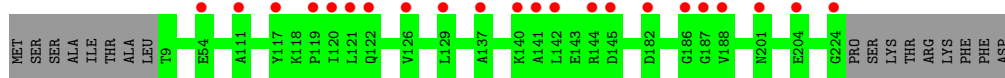
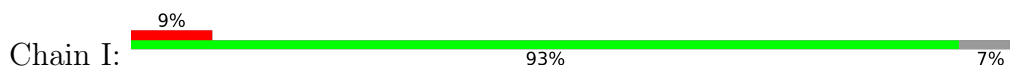

• Molecule 6: V-type proton ATPase subunit E

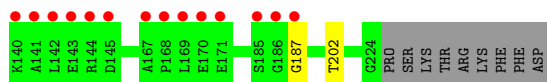
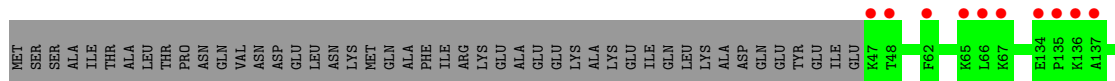
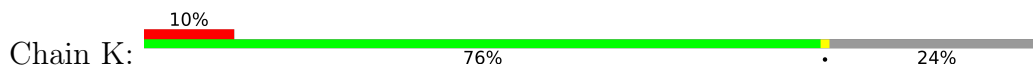

• Molecule 6: V-type proton ATPase subunit E

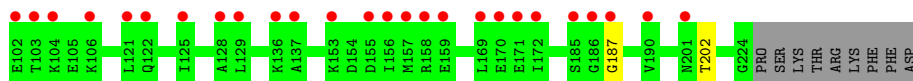
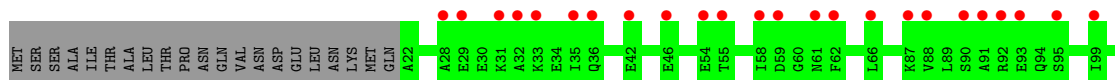
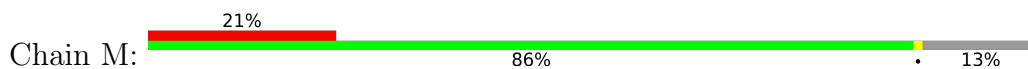

• Molecule 6: V-type proton ATPase subunit E

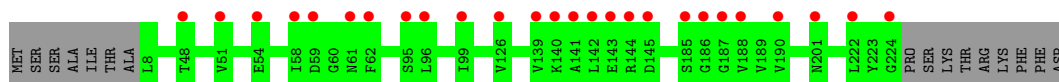

● Molecule 6: V-type proton ATPase subunit E

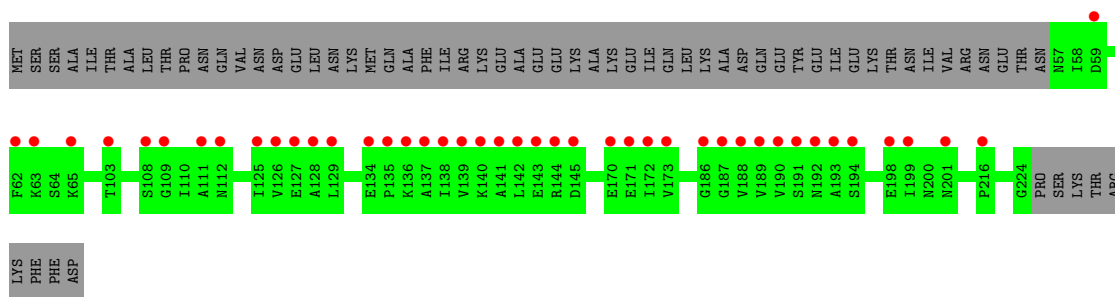

● Molecule 6: V-type proton ATPase subunit E

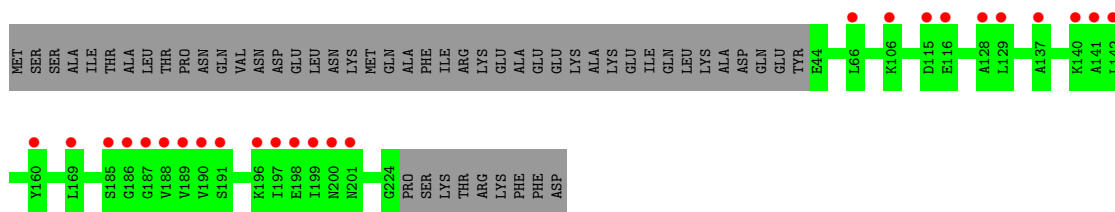
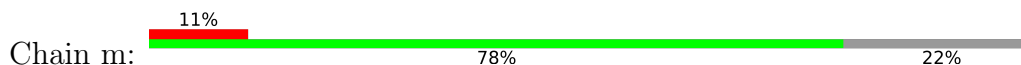

4 Data and refinement statistics

Property	Value	Source
Space group	C 1 2 1	Depositor
Cell constants a, b, c, α , β , γ	468.48Å 159.74Å 245.04Å 90.00° 113.88° 90.00°	Depositor
Resolution (Å)	40.10 – 7.00 40.10 – 7.00	Depositor EDS
% Data completeness (in resolution range)	99.3 (40.10-7.00) 90.4 (40.10-7.00)	Depositor EDS
R_{merge}	0.19	Depositor
R_{sym}	(Not available)	Depositor
$\langle I/\sigma(I) \rangle$ ¹	1.75 (at 7.33Å)	Xtrriage
Refinement program	PHENIX (phenix.refine: dev_1957)	Depositor
R, R_{free}	0.260 , 0.309 0.268 , 0.313	Depositor DCC
R_{free} test set	2000 reflections (7.66%)	wwPDB-VP
Wilson B-factor (Å ²)	321.6	Xtrriage
Anisotropy	0.269	Xtrriage
Bulk solvent k_{sol} (e/Å ³), B_{sol} (Å ²)	0.40 , 999.0	EDS
L-test for twinning ²	$\langle L \rangle = 0.45$, $\langle L^2 \rangle = 0.28$	Xtrriage
Estimated twinning fraction	No twinning to report.	Xtrriage
F_o, F_c correlation	0.80	EDS
Total number of atoms	44760	wwPDB-VP
Average B, all atoms (Å ²)	290.0	wwPDB-VP

Xtrriage's analysis on translational NCS is as follows: *The largest off-origin peak in the Patterson function is 3.45% of the height of the origin peak. No significant pseudotranslation is detected.*

¹Intensities estimated from amplitudes.

²Theoretical values of $\langle |L| \rangle$, $\langle L^2 \rangle$ for acentric reflections are 0.5, 0.333 respectively for untwinned datasets, and 0.375, 0.2 for perfectly twinned datasets.

5 Model quality

5.1 Standard geometry

The Z score for a bond length (or angle) is the number of standard deviations the observed value is removed from the expected value. A bond length (or angle) with $|Z| > 5$ is considered an outlier worth inspection. RMSZ is the root-mean-square of all Z scores of the bond lengths (or angles).

Mol	Chain	Bond lengths		Bond angles	
		RMSZ	# Z >5	RMSZ	# Z >5
1	A	0.18	0/2904	0.31	0/4034
1	B	0.18	0/2919	0.31	0/4055
1	C	0.19	0/2894	0.32	0/4020
1	a	0.18	0/2904	0.31	0/4034
1	b	0.18	0/2894	0.30	0/4020
1	c	0.18	0/2879	0.32	0/3999
2	D	0.18	0/2248	0.30	0/3123
2	E	0.18	0/2229	0.30	0/3097
2	F	0.18	0/2209	0.30	0/3069
2	d	0.18	0/2264	0.30	0/3147
2	e	0.18	0/2243	0.30	0/3116
2	f	0.18	0/2210	0.30	0/3071
3	H	0.19	0/2209	0.32	0/3080
3	h	0.19	0/2205	0.32	0/3075
4	G	0.18	0/689	0.31	0/959
4	g	0.18	0/699	0.30	0/973
5	J	0.18	0/513	0.30	0/713
5	L	0.19	0/334	0.30	0/463
5	N	0.18	0/399	0.30	0/554
5	j	0.18	0/498	0.30	0/692
5	l	0.19	0/324	0.30	0/449
5	n	0.18	0/286	0.29	0/396
6	I	0.18	0/1072	0.29	0/1495
6	K	0.18	0/882	0.29	0/1229
6	M	0.18	0/1007	0.28	0/1404
6	i	0.18	0/1077	0.29	0/1502
6	k	0.18	0/832	0.28	0/1159
6	m	0.18	0/897	0.28	0/1250
All	All	0.18	0/44720	0.31	0/62178

There are no bond length outliers.

There are no bond angle outliers.

There are no chirality outliers.

There are no planarity outliers.

5.2 Too-close contacts

In the following table, the Non-H and H(model) columns list the number of non-hydrogen atoms and hydrogen atoms in the chain respectively. The H(added) column lists the number of hydrogen atoms added and optimized by MolProbity. The Clashes column lists the number of clashes within the asymmetric unit, whereas Symm-Clashes lists symmetry-related clashes.

Mol	Chain	Non-H	H(model)	H(added)	Clashes	Symm-Clashes
1	A	2905	0	1339	12	0
1	B	2920	0	1348	11	0
1	C	2895	0	1335	6	0
1	a	2905	0	1339	0	0
1	b	2895	0	1335	0	0
1	c	2880	0	1326	0	0
2	D	2250	0	1015	8	0
2	E	2231	0	1006	7	0
2	F	2211	0	999	9	0
2	d	2265	0	1022	0	0
2	e	2245	0	1013	0	0
2	f	2212	0	998	0	0
3	H	2212	0	951	2	0
3	h	2208	0	948	0	0
4	G	691	0	311	0	0
4	g	701	0	312	0	0
5	J	514	0	248	0	0
5	L	335	0	160	0	0
5	N	400	0	189	0	0
5	j	499	0	243	0	0
5	l	325	0	150	0	0
5	n	288	0	136	0	0
6	I	1073	0	481	0	0
6	K	883	0	394	1	0
6	M	1008	0	456	1	0
6	i	1078	0	483	0	0
6	k	833	0	374	0	0
6	m	898	0	400	0	0
All	All	44760	0	20311	52	0

The all-atom clashscore is defined as the number of clashes found per 1000 atoms (including hydrogen atoms). The all-atom clashscore for this structure is 1.

All (52) close contacts within the same asymmetric unit are listed below, sorted by their clash magnitude.

Atom-1	Atom-2	Interatomic distance (Å)	Clash overlap (Å)
3:H:352:GLU:HA	3:H:355:SER:HA	1.72	0.72
2:D:28:TYR:H	2:D:93:VAL:H	1.39	0.69
3:H:353:LEU:H	3:H:354:THR:C	1.97	0.68
1:A:383:ALA:HB1	2:E:290:GLU:HA	1.95	0.63
2:D:31:VAL:HA	2:D:41:LEU:HA	1.80	0.63
6:M:187:GLY:HA3	6:M:202:THR:HA	1.80	0.63
1:C:390:ALA:HB1	2:D:245:ALA:HB1	1.80	0.62
6:K:187:GLY:HA3	6:K:202:THR:HA	1.85	0.59
1:A:29:TYR:O	2:D:72:GLY:N	2.37	0.57
2:F:51:GLU:HA	2:F:99:SER:HA	1.87	0.56
2:F:319:ALA:HB2	2:F:331:GLN:H	1.71	0.56
1:B:302:TYR:HA	1:B:311:PRO:HA	1.88	0.55
1:A:145:GLY:H	1:A:160:GLY:HA2	1.73	0.54
1:A:28:ILE:HA	1:A:38:ALA:HA	1.90	0.54
1:B:234:LEU:H	1:B:248:VAL:HA	1.73	0.54
1:B:145:GLY:H	1:B:160:GLY:HA2	1.73	0.54
1:A:233:PRO:HA	1:A:248:VAL:HA	1.90	0.54
1:C:48:GLU:HA	1:C:92:PRO:HA	1.89	0.53
1:B:64:ILE:HA	1:B:69:ALA:HA	1.91	0.53
2:E:300:GLY:N	2:E:304:TYR:O	2.34	0.53
1:B:52:VAL:HA	1:B:86:VAL:HA	1.91	0.53
2:F:154:GLY:O	2:F:452:ARG:N	2.40	0.51
2:D:165:ALA:HB2	2:D:386:ALA:HB2	1.93	0.50
2:F:32:SER:H	2:F:41:LEU:HA	1.77	0.49
1:A:39:GLU:HA	1:A:68:LYS:HA	1.94	0.49
1:B:39:GLU:HA	1:B:68:LYS:HA	1.95	0.49
2:E:51:GLU:HA	2:E:99:SER:HA	1.95	0.48
1:B:152:HIS:HA	1:B:182:THR:HA	1.96	0.48
1:B:74:TYR:HA	1:B:328:ALA:HB3	1.96	0.48
1:A:30:SER:HA	2:D:71:ARG:HA	1.96	0.48
2:F:44:VAL:N	2:F:73:ASP:O	2.37	0.47
1:B:61:VAL:HA	1:B:71:ILE:HA	1.97	0.46
2:F:278:LEU:H	2:F:333:PRO:HA	1.81	0.46
1:A:61:VAL:HA	1:A:71:ILE:HA	1.99	0.45
1:C:493:ALA:HB1	1:C:519:ALA:HB2	1.99	0.44
1:C:500:VAL:O	1:C:504:GLY:N	2.48	0.44
1:C:29:TYR:O	2:F:72:GLY:N	2.44	0.44
2:E:28:TYR:N	2:E:93:VAL:O	2.52	0.43
2:E:29:ASN:HA	2:E:92:THR:HA	1.99	0.43
1:A:398:LYS:HA	1:A:410:SER:HA	2.01	0.43
2:E:140:ASN:O	2:E:144:ARG:N	2.52	0.43
1:A:163:PHE:HA	1:A:170:SER:HA	2.01	0.43

Continued on next page...

Continued from previous page...

Atom-1	Atom-2	Interatomic distance (Å)	Clash overlap (Å)
1:C:233:PRO:HA	1:C:248:VAL:HA	2.01	0.43
1:A:64:ILE:HA	1:A:69:ALA:HA	2.02	0.42
1:B:143:THR:HA	1:B:189:ALA:HB1	2.01	0.42
1:A:198:ILE:H	1:A:211:THR:HA	1.85	0.42
1:B:162:VAL:O	1:B:171:HIS:N	2.40	0.42
2:D:214:ALA:HB3	2:D:242:LEU:HA	2.02	0.41
2:F:67:VAL:HA	2:F:77:VAL:HA	2.02	0.41
2:E:173:PHE:O	2:E:360:VAL:N	2.49	0.41
2:D:167:GLY:HA2	2:D:320:GLY:HA2	2.03	0.41
2:F:276:THR:O	2:F:332:ILE:N	2.36	0.40

There are no symmetry-related clashes.

5.3 Torsion angles [i](#)

5.3.1 Protein backbone [i](#)

In the following table, the Percentiles column shows the percent Ramachandran outliers of the chain as a percentile score with respect to all X-ray entries followed by that with respect to entries of similar resolution.

The Analysed column shows the number of residues for which the backbone conformation was analysed, and the total number of residues.

Mol	Chain	Analysed	Favoured	Allowed	Outliers	Percentiles	
1	A	589/617 (96%)	550 (93%)	34 (6%)	5 (1%)	19	60
1	B	592/617 (96%)	557 (94%)	35 (6%)	0	100	100
1	C	587/617 (95%)	548 (93%)	33 (6%)	6 (1%)	15	54
1	a	589/617 (96%)	550 (93%)	33 (6%)	6 (1%)	15	54
1	b	587/617 (95%)	552 (94%)	35 (6%)	0	100	100
1	c	584/617 (95%)	545 (93%)	33 (6%)	6 (1%)	15	54
2	D	453/517 (88%)	425 (94%)	28 (6%)	0	100	100
2	E	449/517 (87%)	428 (95%)	21 (5%)	0	100	100
2	F	445/517 (86%)	420 (94%)	25 (6%)	0	100	100
2	d	458/517 (89%)	429 (94%)	28 (6%)	1 (0%)	47	81
2	e	452/517 (87%)	431 (95%)	21 (5%)	0	100	100
2	f	445/517 (86%)	421 (95%)	23 (5%)	1 (0%)	47	81

Continued on next page...

Continued from previous page...

Mol	Chain	Analysed	Favoured	Allowed	Outliers	Percentiles	
3	H	439/478 (92%)	412 (94%)	27 (6%)	0	100	100
3	h	438/478 (92%)	412 (94%)	25 (6%)	1 (0%)	47	81
4	G	135/256 (53%)	130 (96%)	4 (3%)	1 (1%)	22	63
4	g	137/256 (54%)	134 (98%)	3 (2%)	0	100	100
5	J	102/122 (84%)	100 (98%)	2 (2%)	0	100	100
5	L	66/122 (54%)	65 (98%)	1 (2%)	0	100	100
5	N	79/122 (65%)	75 (95%)	4 (5%)	0	100	100
5	j	99/122 (81%)	97 (98%)	2 (2%)	0	100	100
5	l	64/122 (52%)	63 (98%)	1 (2%)	0	100	100
5	n	54/122 (44%)	51 (94%)	3 (6%)	0	100	100
6	I	214/233 (92%)	213 (100%)	1 (0%)	0	100	100
6	K	176/233 (76%)	175 (99%)	1 (1%)	0	100	100
6	M	201/233 (86%)	200 (100%)	1 (0%)	0	100	100
6	i	215/233 (92%)	213 (99%)	2 (1%)	0	100	100
6	k	166/233 (71%)	165 (99%)	1 (1%)	0	100	100
6	m	179/233 (77%)	178 (99%)	1 (1%)	0	100	100
All	All	8994/10402 (86%)	8539 (95%)	428 (5%)	27 (0%)	41	77

All (27) Ramachandran outliers are listed below:

Mol	Chain	Res	Type
1	C	187	ALA
1	C	188	PRO
4	G	138	ILE
1	c	187	ALA
1	c	188	PRO
1	A	589	GLU
1	C	144	PRO
1	a	589	GLU
1	c	144	PRO
1	A	590	PRO
1	C	305	MET
3	h	152	GLN
1	a	590	PRO
1	c	305	MET
2	d	200	VAL

Continued on next page...

Continued from previous page...

Mol	Chain	Res	Type
1	A	187	ALA
1	A	309	LYS
1	A	476	TYR
1	a	187	ALA
1	a	309	LYS
1	C	145	GLY
1	C	146	LYS
1	c	145	GLY
1	c	146	LYS
1	a	477	PRO
1	a	452	PHE
2	f	370	TYR

5.3.2 Protein sidechains [i](#)

There are no protein residues with a non-rotameric sidechain to report in this entry.

5.3.3 RNA [i](#)

There are no RNA molecules in this entry.

5.4 Non-standard residues in protein, DNA, RNA chains [i](#)

There are no non-standard protein/DNA/RNA residues in this entry.

5.5 Carbohydrates [i](#)

There are no monosaccharides in this entry.

5.6 Ligand geometry [i](#)

There are no ligands in this entry.

5.7 Other polymers [i](#)

There are no such residues in this entry.

5.8 Polymer linkage issues

There are no chain breaks in this entry.

6 Fit of model and data i

6.1 Protein, DNA and RNA chains i

In the following table, the column labelled ‘#RSRZ > 2’ contains the number (and percentage) of RSRZ outliers, followed by percent RSRZ outliers for the chain as percentile scores relative to all X-ray entries and entries of similar resolution. The OWAB column contains the minimum, median, 95th percentile and maximum values of the occupancy-weighted average B-factor per residue. The column labelled ‘Q < 0.9’ lists the number of (and percentage) of residues with an average occupancy less than 0.9.

Mol	Chain	Analysed	<RSRZ>	#RSRZ>2	OWAB(Å ²)	Q<0.9
1	A	591/617 (95%)	0.56	92 (15%) 2 5	126, 311, 475, 652	0
1	B	594/617 (96%)	0.34	65 (10%) 5 9	107, 290, 447, 594	0
1	C	589/617 (95%)	0.40	59 (10%) 7 10	111, 281, 475, 610	0
1	a	591/617 (95%)	0.80	102 (17%) 1 4	126, 314, 475, 658	0
1	b	589/617 (95%)	0.34	61 (10%) 6 9	107, 292, 450, 597	0
1	c	586/617 (94%)	0.34	52 (8%) 9 12	111, 282, 473, 614	0
2	D	457/517 (88%)	-0.08	7 (1%) 73 65	92, 239, 384, 587	0
2	E	453/517 (87%)	0.07	14 (3%) 49 42	124, 258, 413, 663	0
2	F	449/517 (86%)	0.08	28 (6%) 20 20	146, 287, 414, 584	0
2	d	460/517 (88%)	0.04	19 (4%) 37 34	94, 241, 390, 586	0
2	e	456/517 (88%)	0.12	23 (5%) 28 28	125, 258, 415, 667	0
2	f	449/517 (86%)	0.15	30 (6%) 17 18	145, 288, 416, 573	0
3	H	445/478 (93%)	-0.55	1 (0%) 95 93	65, 163, 317, 625	0
3	h	444/478 (92%)	-0.48	2 (0%) 91 85	61, 164, 321, 631	0
4	G	139/256 (54%)	-0.19	0 100 100	93, 212, 488, 554	0
4	g	141/256 (55%)	-0.45	0 100 100	97, 213, 493, 560	0
5	J	104/122 (85%)	0.05	4 (3%) 40 36	154, 290, 427, 498	0
5	L	68/122 (55%)	0.75	10 (14%) 2 5	283, 418, 525, 566	0
5	N	81/122 (66%)	1.31	23 (28%) 0 2	200, 450, 574, 740	0
5	j	101/122 (82%)	0.23	5 (4%) 28 28	151, 282, 419, 497	0
5	l	66/122 (54%)	0.98	13 (19%) 1 3	279, 422, 522, 566	0
5	n	58/122 (47%)	0.18	2 (3%) 45 40	200, 441, 509, 541	0
6	I	216/233 (92%)	0.50	22 (10%) 6 10	112, 345, 497, 643	0
6	K	178/233 (76%)	0.57	24 (13%) 3 6	186, 344, 491, 599	0

Continued on next page...

Continued from previous page...

Mol	Chain	Analysed	<RSRZ>	#RSRZ>2	OWAB(Å ²)	Q<0.9
6	M	203/233 (87%)	1.26	50 (24%) 0 2	200, 410, 571, 626	0
6	i	217/233 (93%)	0.55	26 (11%) 4 8	91, 345, 511, 638	0
6	k	168/233 (72%)	1.23	43 (25%) 0 2	187, 331, 466, 514	0
6	m	181/233 (77%)	0.72	25 (13%) 2 6	200, 402, 542, 587	0
All	All	9074/10402 (87%)	0.27	802 (8%) 10 12	61, 281, 479, 740	0

All (802) RSRZ outliers are listed below:

Mol	Chain	Res	Type	RSRZ
1	a	149	VAL	18.8
1	a	148	GLN	16.8
1	A	151	ASP	11.9
1	A	148	GLN	11.6
1	a	150	GLY	11.4
6	i	187	GLY	10.0
1	A	149	VAL	9.7
1	A	152	HIS	9.6
1	a	151	ASP	9.6
6	i	186	GLY	9.3
1	a	159	TYR	9.2
1	a	184	THR	9.2
1	A	147	PHE	8.3
6	I	187	GLY	8.3
1	a	173	ILE	7.8
6	k	171	GLU	7.6
1	A	150	GLY	7.6
1	a	185	TRP	7.3
1	a	565	GLY	7.2
6	M	187	GLY	7.1
1	a	183	ILE	7.1
1	B	147	PHE	7.0
6	I	186	GLY	6.9
1	A	159	TYR	6.8
1	a	566	ALA	6.7
1	C	123	ILE	6.7
1	B	231	ASP	6.7
6	k	190	VAL	6.7
6	k	191	SER	6.6
1	a	158	ILE	6.6
6	k	137	ALA	6.4
5	l	61	ASN	6.1

Continued on next page...

Continued from previous page...

Mol	Chain	Res	Type	RSRZ
1	A	144	PRO	6.0
1	B	146	LYS	6.0
1	a	160	GLY	6.0
1	a	585	SER	5.9
1	a	147	PHE	5.9
1	A	211	THR	5.9
6	M	186	GLY	5.9
1	C	574	SER	5.8
1	c	180	ARG	5.8
2	F	87	ASP	5.8
1	b	44	CYS	5.8
1	a	188	PRO	5.7
1	a	186	ILE	5.7
6	m	187	GLY	5.7
1	a	586	LYS	5.7
6	i	188	VAL	5.7
2	f	127	PHE	5.6
1	C	407	ARG	5.6
1	B	159	TYR	5.6
6	M	103	THR	5.5
5	N	87	ALA	5.5
1	B	99	PRO	5.5
6	m	198	GLU	5.4
1	A	44	CYS	5.4
1	a	198	ILE	5.4
2	f	87	ASP	5.4
1	A	153	ILE	5.3
1	C	406	ASP	5.3
1	b	99	PRO	5.3
1	A	184	THR	5.3
6	i	141	ALA	5.3
6	k	172	ILE	5.2
6	m	186	GLY	5.2
1	a	99	PRO	5.2
1	C	259	PHE	5.2
1	A	190	GLY	5.2
1	C	180	ARG	5.1
1	A	173	ILE	5.1
1	A	198	ILE	5.1
1	A	146	LYS	5.1
1	a	187	ALA	5.1
1	a	564	ASN	5.1

Continued on next page...

Continued from previous page...

Mol	Chain	Res	Type	RSRZ
1	A	185	TRP	5.1
2	E	86	ILE	5.0
1	c	192	TYR	5.0
6	k	187	GLY	5.0
1	C	122	SER	5.0
1	a	212	LEU	4.9
2	e	129	GLU	4.9
1	B	98	GLY	4.9
1	B	44	CYS	4.9
6	k	138	ILE	4.8
1	A	183	ILE	4.8
6	m	199	ILE	4.8
6	k	199	ILE	4.8
1	C	408	THR	4.8
1	b	159	TYR	4.7
1	A	186	ILE	4.7
1	A	158	ILE	4.7
1	c	140	TRP	4.7
2	f	30	THR	4.7
1	B	187	ALA	4.6
2	e	105	SER	4.6
2	f	395	ASP	4.6
1	A	212	LEU	4.6
6	k	173	VAL	4.5
1	a	152	HIS	4.5
1	a	88	ARG	4.5
2	F	86	ILE	4.5
1	B	148	GLN	4.5
2	e	106	GLU	4.5
1	B	160	GLY	4.5
1	B	209	ASP	4.4
1	a	192	TYR	4.4
6	I	141	ALA	4.4
1	a	347	GLN	4.4
1	b	147	PHE	4.4
6	k	136	LYS	4.4
1	c	153	ILE	4.4
1	A	188	PRO	4.3
6	k	128	ALA	4.3
6	k	192	ASN	4.3
1	B	211	THR	4.3
2	f	128	ALA	4.2

Continued on next page...

Continued from previous page...

Mol	Chain	Res	Type	RSRZ
1	B	408	THR	4.2
1	B	153	ILE	4.2
6	M	91	ALA	4.2
1	b	149	VAL	4.2
1	A	174	LEU	4.2
1	c	123	ILE	4.2
6	k	59	ASP	4.1
1	a	172	LYS	4.1
1	c	181	GLY	4.1
6	i	54	GLU	4.1
2	f	29	ASN	4.1
1	a	44	CYS	4.1
1	a	200	GLU	4.1
1	c	567	ASN	4.1
6	k	188	VAL	4.1
1	b	25	TYR	4.1
1	b	43	GLY	4.1
1	A	210	PHE	4.1
1	a	561	ALA	4.1
1	b	45	ALA	4.0
5	l	106	SER	4.0
1	a	567	ASN	4.0
1	a	146	LYS	4.0
1	a	182	THR	4.0
1	c	575	THR	4.0
6	k	134	GLU	4.0
1	B	198	ILE	4.0
1	A	565	GLY	4.0
1	a	179	SER	3.9
6	K	134	GLU	3.9
1	A	182	THR	3.9
1	C	575	THR	3.9
2	f	86	ILE	3.9
6	i	145	ASP	3.9
1	A	45	ALA	3.9
1	C	153	ILE	3.9
2	d	395	ASP	3.9
5	N	88	GLU	3.9
1	b	148	GLN	3.9
1	B	144	PRO	3.9
1	B	210	PHE	3.8
5	N	72	ALA	3.8

Continued on next page...

Continued from previous page...

Mol	Chain	Res	Type	RSRZ
1	a	174	LEU	3.8
1	A	179	SER	3.8
1	A	99	PRO	3.8
1	B	173	ILE	3.8
1	b	154	SER	3.8
1	A	187	ALA	3.8
6	m	190	VAL	3.8
1	a	558	ALA	3.8
1	B	171	HIS	3.7
1	B	172	LYS	3.7
2	E	325	ARG	3.7
6	k	108	SER	3.7
6	I	188	VAL	3.7
2	e	130	ASP	3.7
6	k	135	PRO	3.7
6	K	167	ALA	3.7
1	A	181	GLY	3.7
1	A	88	ARG	3.7
6	k	201	ASN	3.7
1	A	160	GLY	3.7
1	C	590	PRO	3.7
1	a	86	VAL	3.7
6	M	102	GLU	3.7
1	a	202	GLU	3.6
1	b	179	SER	3.6
1	A	157	ASP	3.6
1	a	153	ILE	3.6
2	e	86	ILE	3.6
1	a	557	GLU	3.6
1	c	77	THR	3.6
1	b	144	PRO	3.6
1	B	158	ILE	3.6
1	A	197	LYS	3.6
1	A	28	ILE	3.6
1	c	574	SER	3.6
1	c	147	PHE	3.6
1	A	27	ALA	3.6
1	A	199	LEU	3.6
1	A	145	GLY	3.6
5	L	61	ASN	3.6
2	e	87	ASP	3.6
1	B	409	GLY	3.6

Continued on next page...

Continued from previous page...

Mol	Chain	Res	Type	RSRZ
1	b	98	GLY	3.6
6	M	32	ALA	3.5
6	k	170	GLU	3.5
6	m	188	VAL	3.5
5	l	58	GLU	3.5
1	B	45	ALA	3.5
1	c	152	HIS	3.5
2	E	87	ASP	3.5
1	a	193	THR	3.5
5	L	87	ALA	3.5
6	k	109	GLY	3.5
6	M	29	GLU	3.5
1	a	239	ARG	3.5
6	M	171	GLU	3.5
6	k	189	VAL	3.5
1	A	176	PRO	3.5
1	B	176	PRO	3.5
6	K	135	PRO	3.5
1	b	161	SER	3.4
6	K	47	LYS	3.4
6	I	182	ASP	3.4
6	M	156	ILE	3.4
1	C	401	ALA	3.4
2	e	128	ALA	3.4
1	B	200	GLU	3.4
5	N	49	GLN	3.4
1	b	173	ILE	3.4
1	B	145	GLY	3.4
1	C	192	TYR	3.4
6	M	137	ALA	3.4
1	A	200	GLU	3.4
1	A	39	GLU	3.4
6	k	126	VAL	3.4
2	e	107	ASP	3.4
1	C	193	THR	3.4
1	b	150	GLY	3.4
1	c	99	PRO	3.3
1	C	42	ILE	3.3
1	c	179	SER	3.3
2	F	29	ASN	3.3
1	C	135	ASP	3.3
5	N	91	LYS	3.3

Continued on next page...

Continued from previous page...

Mol	Chain	Res	Type	RSRZ
6	M	99	ILE	3.3
6	i	142	LEU	3.3
6	M	106	LYS	3.3
6	K	66	LEU	3.3
1	a	27	ALA	3.3
1	C	404	SER	3.3
1	C	260	GLY	3.3
6	k	129	LEU	3.3
1	C	44	CYS	3.3
1	a	515	THR	3.3
6	M	125	ILE	3.3
1	b	146	LYS	3.3
5	j	102	VAL	3.3
1	c	154	SER	3.3
2	d	398	ASP	3.3
2	e	127	PHE	3.3
1	c	151	ASP	3.3
1	A	586	LYS	3.3
2	f	324	GLY	3.3
6	m	115	ASP	3.3
1	B	186	ILE	3.3
6	m	141	ALA	3.3
1	a	28	ILE	3.3
2	F	88	VAL	3.3
6	m	191	SER	3.3
1	b	153	ILE	3.2
6	M	157	MET	3.2
1	A	566	ALA	3.2
6	i	143	GLU	3.2
2	D	395	ASP	3.2
6	M	172	ILE	3.2
2	E	324	GLY	3.2
5	l	59	GLN	3.2
6	k	145	ASP	3.2
1	B	152	HIS	3.2
1	b	160	GLY	3.2
5	N	84	LYS	3.2
1	C	258	ALA	3.2
1	B	589	GLU	3.2
2	d	136	GLY	3.2
1	c	124	TYR	3.2
2	F	207	ASN	3.2

Continued on next page...

Continued from previous page...

Mol	Chain	Res	Type	RSRZ
2	f	27	ASN	3.2
2	E	326	ASN	3.2
2	f	398	ASP	3.2
5	l	60	LYS	3.2
5	N	68	LEU	3.1
1	a	562	VAL	3.1
1	c	139	LYS	3.1
1	C	212	LEU	3.1
6	m	200	ASN	3.1
1	C	286	GLU	3.1
2	d	203	GLY	3.1
6	k	141	ALA	3.1
6	K	140	LYS	3.1
1	C	179	SER	3.1
1	a	568	TRP	3.1
1	b	212	LEU	3.1
6	M	159	GLU	3.1
6	M	190	VAL	3.1
1	c	38	ALA	3.1
2	f	140	ASN	3.1
1	C	261	CYS	3.1
2	F	126	VAL	3.1
6	M	185	SER	3.1
6	K	141	ALA	3.1
1	C	43	GLY	3.1
1	C	251	GLY	3.1
6	i	185	SER	3.1
6	I	121	LEU	3.1
6	I	201	ASN	3.1
5	N	42	GLU	3.1
6	M	58	ILE	3.1
2	f	89	LYS	3.0
1	B	170	SER	3.0
1	A	346	ASP	3.0
1	B	38	ALA	3.0
1	A	239	ARG	3.0
6	K	168	PRO	3.0
1	B	154	SER	3.0
1	a	201	VAL	3.0
6	M	90	SER	3.0
1	A	154	SER	3.0
5	l	62	ALA	3.0

Continued on next page...

Continued from previous page...

Mol	Chain	Res	Type	RSRZ
6	m	185	SER	3.0
1	B	43	GLY	3.0
1	a	199	LEU	3.0
6	k	193	ALA	3.0
2	f	88	VAL	3.0
6	m	116	GLU	3.0
1	a	154	SER	3.0
1	C	152	HIS	3.0
1	a	607	THR	3.0
1	B	151	ASP	3.0
2	f	239	SER	3.0
1	A	189	ALA	3.0
6	M	155	ASP	3.0
1	C	154	SER	3.0
6	i	201	ASN	2.9
2	F	462	TRP	2.9
1	A	347	GLN	2.9
1	A	178	ARG	2.9
1	C	248	VAL	2.9
2	D	199	ASP	2.9
2	d	396	HIS	2.9
1	a	211	THR	2.9
1	B	199	LEU	2.9
1	a	87	LEU	2.9
6	M	92	ARG	2.9
6	M	128	ALA	2.9
1	A	201	VAL	2.9
1	a	238	GLN	2.9
1	c	585	SER	2.9
1	a	25	TYR	2.9
6	I	117	TYR	2.9
1	C	405	PRO	2.9
6	M	95	SER	2.9
5	L	54	LEU	2.9
1	a	26	GLY	2.9
1	a	98	GLY	2.9
5	N	53	GLU	2.9
1	B	182	THR	2.9
1	a	144	PRO	2.9
6	k	111	ALA	2.9
6	M	201	ASN	2.9
1	c	248	VAL	2.9

Continued on next page...

Continued from previous page...

Mol	Chain	Res	Type	RSRZ
1	C	589	GLU	2.9
1	C	249	GLN	2.9
6	i	144	ARG	2.9
1	b	247	CYS	2.9
1	A	585	SER	2.9
1	b	248	VAL	2.9
6	m	189	VAL	2.9
1	b	231	ASP	2.8
5	N	80	LEU	2.8
6	i	139	VAL	2.8
1	B	184	THR	2.8
2	F	127	PHE	2.8
2	F	395	ASP	2.8
1	A	539	CYS	2.8
1	B	214	HIS	2.8
1	A	196	GLU	2.8
6	k	125	ILE	2.8
1	b	230	ALA	2.8
5	J	98	LEU	2.8
6	M	55	THR	2.8
1	A	401	ALA	2.8
1	a	401	ALA	2.8
5	l	64	GLY	2.8
5	L	65	VAL	2.8
6	I	145	ASP	2.8
1	c	141	GLN	2.8
1	b	157	ASP	2.8
6	m	137	ALA	2.8
1	a	611	ARG	2.8
2	F	464	LEU	2.8
2	d	204	HIS	2.8
6	M	28	ALA	2.8
1	A	130	ASP	2.8
1	b	143	THR	2.8
5	N	50	LYS	2.8
1	a	157	ASP	2.8
1	B	162	VAL	2.8
1	A	69	ALA	2.8
1	a	346	ASP	2.8
6	k	186	GLY	2.7
6	m	197	ILE	2.7
2	e	323	GLU	2.7

Continued on next page...

Continued from previous page...

Mol	Chain	Res	Type	RSRZ
1	B	213	TYR	2.7
1	C	124	TYR	2.7
1	B	189	ALA	2.7
6	I	144	ARG	2.7
1	A	213	TYR	2.7
1	a	162	VAL	2.7
2	e	303	GLY	2.7
5	L	51	ASP	2.7
6	k	142	LEU	2.7
1	B	201	VAL	2.7
2	f	399	VAL	2.7
6	K	48	THR	2.7
5	J	102	VAL	2.7
1	A	175	LEU	2.7
1	a	574	SER	2.7
1	a	575	THR	2.7
1	A	172	LYS	2.7
1	C	231	ASP	2.7
1	a	180	ARG	2.7
1	c	69	ALA	2.7
6	k	127	GLU	2.7
1	B	100	GLY	2.7
1	c	157	ASP	2.7
6	k	139	VAL	2.7
1	B	208	SER	2.7
1	b	122	SER	2.7
2	f	402	GLN	2.7
2	f	486	ASP	2.7
1	C	250	GLY	2.7
1	a	181	GLY	2.7
1	b	249	GLN	2.7
5	N	76	VAL	2.7
6	k	65	LYS	2.7
1	A	43	GLY	2.7
1	A	403	GLY	2.7
1	C	191	GLU	2.7
1	c	191	GLU	2.7
1	b	145	GLY	2.7
3	H	134	GLY	2.7
1	b	251	GLY	2.6
1	c	193	THR	2.6
1	A	156	GLY	2.6

Continued on next page...

Continued from previous page...

Mol	Chain	Res	Type	RSRZ
1	B	161	SER	2.6
1	C	225	THR	2.6
5	l	65	VAL	2.6
2	F	321	ARG	2.6
1	A	40	ASN	2.6
1	B	188	PRO	2.6
1	C	587	PHE	2.6
1	A	38	ALA	2.6
1	b	611	ARG	2.6
6	K	170	GLU	2.6
6	M	158	ARG	2.6
2	e	88	VAL	2.6
2	d	33	GLY	2.6
1	A	155	GLY	2.6
6	i	58	ILE	2.6
6	k	112	ASN	2.6
1	c	78	ALA	2.6
1	c	396	ALA	2.6
2	d	135	ASN	2.6
1	A	209	ASP	2.6
1	C	400	VAL	2.6
2	F	327	GLY	2.6
2	F	466	ARG	2.6
6	K	145	ASP	2.6
6	K	187	GLY	2.6
1	B	123	ILE	2.6
1	A	24	GLU	2.6
1	B	196	GLU	2.6
1	b	151	ASP	2.6
6	m	201	ASN	2.6
5	N	86	ILE	2.6
2	F	328	SER	2.6
6	M	33	LYS	2.6
1	A	404	SER	2.6
6	I	140	LYS	2.6
6	m	140	LYS	2.6
6	M	31	LYS	2.6
1	B	97	LEU	2.6
1	a	85	PRO	2.6
1	C	247	CYS	2.6
2	f	323	GLU	2.6
6	K	136	LYS	2.6

Continued on next page...

Continued from previous page...

Mol	Chain	Res	Type	RSRZ
1	C	211	THR	2.6
1	a	143	THR	2.6
1	a	409	GLY	2.5
2	E	88	VAL	2.5
1	A	238	GLN	2.5
1	C	66	GLY	2.5
6	M	87	LYS	2.5
2	E	105	SER	2.5
6	I	119	PRO	2.5
6	I	142	LEU	2.5
6	m	129	LEU	2.5
1	b	33	GLY	2.5
1	c	44	CYS	2.5
5	l	53	GLU	2.5
2	D	70	ILE	2.5
6	M	129	LEU	2.5
6	I	120	ILE	2.5
1	B	346	ASP	2.5
6	I	122	GLN	2.5
2	D	207	ASN	2.5
6	M	59	ASP	2.5
1	B	174	LEU	2.5
1	a	145	GLY	2.5
6	k	140	LYS	2.5
1	B	212	LEU	2.5
6	M	136	LYS	2.5
1	b	59	GLY	2.5
6	K	185	SER	2.5
6	M	54	GLU	2.5
6	k	62	PHE	2.5
1	a	506	SER	2.5
6	i	96	LEU	2.5
6	M	62	PHE	2.5
1	c	590	PRO	2.5
6	k	63	LYS	2.5
1	A	67	ASP	2.5
1	a	82	VAL	2.5
2	d	476	ILE	2.5
5	l	57	PHE	2.5
6	M	42	GLU	2.5
1	c	33	GLY	2.4
1	c	169	SER	2.4

Continued on next page...

Continued from previous page...

Mol	Chain	Res	Type	RSRZ
1	c	231	ASP	2.4
6	K	62	PHE	2.4
6	m	196	LYS	2.4
1	a	71	ILE	2.4
5	J	43	ILE	2.4
2	E	425	LEU	2.4
1	c	184	THR	2.4
1	C	28	ILE	2.4
1	C	585	SER	2.4
2	d	399	VAL	2.4
1	B	59	GLY	2.4
2	f	206	GLU	2.4
1	C	121	GLN	2.4
2	d	75	ALA	2.4
2	D	47	PRO	2.4
1	C	181	GLY	2.4
1	B	175	LEU	2.4
2	f	422	GLU	2.4
1	A	66	GLY	2.4
1	a	45	ALA	2.4
2	E	424	ALA	2.4
6	K	137	ALA	2.4
1	c	182	THR	2.4
1	b	88	ARG	2.4
5	N	65	VAL	2.4
6	I	111	ALA	2.4
6	i	59	ASP	2.4
1	a	53	GLY	2.4
1	A	143	THR	2.4
1	b	41	MET	2.4
2	F	30	THR	2.4
6	I	54	GLU	2.4
6	i	61	ASN	2.4
2	F	84	SER	2.4
6	K	67	LYS	2.4
6	m	142	LEU	2.4
2	d	96	THR	2.4
5	J	103	ILE	2.4
1	b	158	ILE	2.4
2	F	398	ASP	2.4
1	c	568	TRP	2.4
2	E	128	ALA	2.4

Continued on next page...

Continued from previous page...

Mol	Chain	Res	Type	RSRZ
2	e	410	GLY	2.4
1	a	24	GLU	2.4
1	a	140	TRP	2.4
1	a	583	SER	2.4
1	A	611	ARG	2.4
1	C	178	ARG	2.4
1	a	578	VAL	2.4
5	N	83	ILE	2.3
1	A	610	GLU	2.3
6	M	93	GLU	2.3
2	F	467	ILE	2.3
1	C	140	TRP	2.3
5	N	81	ALA	2.3
5	j	87	ALA	2.3
6	k	143	GLU	2.3
1	a	404	SER	2.3
1	c	148	GLN	2.3
6	I	224	GLY	2.3
1	b	42	ILE	2.3
1	C	224	VAL	2.3
5	L	50	LYS	2.3
6	M	170	GLU	2.3
6	M	61	ASN	2.3
1	A	100	GLY	2.3
1	a	512	ASP	2.3
6	i	99	ILE	2.3
1	b	213	TYR	2.3
2	e	197	THR	2.3
1	a	240	VAL	2.3
1	c	122	SER	2.3
1	a	72	GLN	2.3
2	f	28	TYR	2.3
1	b	211	THR	2.3
5	N	46	TYR	2.3
6	K	169	LEU	2.3
1	C	403	GLY	2.3
2	d	198	LYS	2.3
1	a	52	VAL	2.3
1	A	37	ILE	2.3
2	d	477	SER	2.3
6	I	126	VAL	2.3
6	M	88	VAL	2.3

Continued on next page...

Continued from previous page...

Mol	Chain	Res	Type	RSRZ
1	B	69	ALA	2.3
2	F	424	ALA	2.3
2	d	202	ASP	2.3
1	a	584	SER	2.3
2	f	143	ALA	2.3
6	M	153	LYS	2.3
1	b	546	ASP	2.3
1	a	610	GLU	2.3
5	j	3	GLN	2.3
1	A	402	LEU	2.3
1	A	567	ASN	2.3
1	A	558	ALA	2.3
5	l	87	ALA	2.3
6	m	128	ALA	2.3
1	C	468	LEU	2.3
1	a	141	GLN	2.3
1	a	609	GLN	2.3
1	b	184	THR	2.3
2	e	205	GLU	2.3
3	h	4	THR	2.2
6	M	36	GLN	2.2
2	D	135	ASN	2.2
5	N	85	LYS	2.2
6	m	169	LEU	2.2
1	A	142	PHE	2.2
1	b	172	LYS	2.2
1	b	607	THR	2.2
6	M	104	LYS	2.2
1	B	157	ASP	2.2
1	c	66	GLY	2.2
2	f	31	VAL	2.2
2	f	167	GLY	2.2
6	i	51	VAL	2.2
6	m	106	LYS	2.2
1	A	26	GLY	2.2
2	e	322	VAL	2.2
6	K	143	GLU	2.2
6	i	140	LYS	2.2
1	A	453	PRO	2.2
1	A	192	TYR	2.2
6	i	62	PHE	2.2
6	m	66	LEU	2.2

Continued on next page...

Continued from previous page...

Mol	Chain	Res	Type	RSRZ
1	A	589	GLU	2.2
1	c	251	GLY	2.2
2	f	214	ALA	2.2
1	c	183	ILE	2.2
6	i	126	VAL	2.2
1	a	171	HIS	2.2
1	A	25	TYR	2.2
2	d	47	PRO	2.2
1	A	36	VAL	2.2
1	c	156	GLY	2.2
1	c	275	ASN	2.2
5	N	54	LEU	2.2
6	k	198	GLU	2.2
1	C	99	PRO	2.2
6	k	144	ARG	2.2
1	C	567	ASN	2.2
1	c	125	ILE	2.2
2	d	461	ALA	2.2
5	n	26	LYS	2.2
6	I	129	LEU	2.2
6	m	160	TYR	2.2
1	C	285	GLY	2.2
1	c	43	GLY	2.2
1	A	462	SER	2.2
2	F	89	LYS	2.2
2	F	461	ALA	2.2
1	B	407	ARG	2.2
1	B	169	SER	2.2
5	l	90	LYS	2.2
1	B	179	SER	2.2
1	a	100	GLY	2.1
2	E	303	GLY	2.1
1	b	603	LYS	2.1
1	c	566	ALA	2.1
1	b	606	SER	2.1
3	h	298	CYS	2.1
1	b	540	PRO	2.1
1	a	191	GLU	2.1
1	b	26	GLY	2.1
1	b	539	CYS	2.1
2	f	211	VAL	2.1
5	L	90	LYS	2.1

Continued on next page...

Continued from previous page...

Mol	Chain	Res	Type	RSRZ
6	M	121	LEU	2.1
2	f	25	ARG	2.1
2	e	125	LYS	2.1
2	e	126	VAL	2.1
6	k	103	THR	2.1
6	M	46	GLU	2.1
6	K	144	ARG	2.1
1	B	50	VAL	2.1
2	E	323	GLU	2.1
2	F	122	ASN	2.1
5	L	55	LYS	2.1
2	e	131	TYR	2.1
2	f	321	ARG	2.1
2	e	104	VAL	2.1
5	L	91	LYS	2.1
2	F	402	GLN	2.1
2	f	85	GLY	2.1
5	N	45	SER	2.1
6	M	35	ILE	2.1
1	A	614	GLU	2.1
1	b	198	ILE	2.1
2	F	107	ASP	2.1
5	N	56	GLU	2.1
6	K	142	LEU	2.1
6	i	48	THR	2.1
1	c	378	ASP	2.1
1	a	213	TYR	2.1
2	F	269	GLN	2.1
2	e	30	THR	2.1
6	K	186	GLY	2.1
6	M	169	LEU	2.1
2	e	196	PRO	2.1
1	b	543	LYS	2.1
5	l	63	GLY	2.1
2	f	396	HIS	2.1
2	e	299	PRO	2.1
1	C	257	GLY	2.1
1	A	131	THR	2.1
2	E	420	VAL	2.1
2	d	207	ASN	2.1
6	k	216	PRO	2.1
6	K	171	GLU	2.1

Continued on next page...

Continued from previous page...

Mol	Chain	Res	Type	RSRZ
1	a	243	ALA	2.1
1	c	261	CYS	2.1
6	M	66	LEU	2.1
1	c	404	SER	2.1
1	B	195	ASP	2.1
1	A	180	ARG	2.1
5	j	101	THR	2.1
1	B	197	LYS	2.1
2	d	400	SER	2.1
2	F	355	GLU	2.1
1	a	590	PRO	2.1
2	F	463	SER	2.1
6	M	122	GLN	2.1
1	a	405	PRO	2.1
1	C	287	ARG	2.1
1	b	90	GLY	2.1
1	b	250	GLY	2.1
1	b	613	ALA	2.1
6	I	137	ALA	2.1
6	k	194	SER	2.1
1	b	89	THR	2.0
5	L	94	VAL	2.0
2	E	196	PRO	2.0
6	K	65	LYS	2.0
1	b	589	GLU	2.0
1	a	582	VAL	2.0
1	c	406	ASP	2.0
6	i	190	VAL	2.0
1	C	540	PRO	2.0
2	F	421	GLY	2.0
1	c	608	MET	2.0
6	i	222	LEU	2.0
1	C	284	CYS	2.0
1	b	174	LEU	2.0
1	C	348	GLY	2.0
1	a	237	GLY	2.0
1	c	403	GLY	2.0
1	B	194	LEU	2.0
1	b	609	GLN	2.0
5	n	106	SER	2.0
6	I	204	GLU	2.0
2	D	476	ILE	2.0

Continued on next page...

Continued from previous page...

Mol	Chain	Res	Type	RSRZ
5	N	55	LYS	2.0
1	b	50	VAL	2.0
5	N	51	ASP	2.0
1	b	550	ALA	2.0
5	j	50	LYS	2.0
1	B	137	THR	2.0
6	i	95	SER	2.0
1	B	181	GLY	2.0
1	A	70	THR	2.0
1	a	539	CYS	2.0
1	a	608	MET	2.0
6	i	224	GLY	2.0
1	a	210	PHE	2.0
1	b	175	LEU	2.0

6.2 Non-standard residues in protein, DNA, RNA chains [i](#)

There are no non-standard protein/DNA/RNA residues in this entry.

6.3 Carbohydrates [i](#)

There are no monosaccharides in this entry.

6.4 Ligands [i](#)

There are no ligands in this entry.

6.5 Other polymers [i](#)

There are no such residues in this entry.