



Full wwPDB X-ray Structure Validation Report ⓘ

Oct 30, 2023 – 02:06 PM JST

PDB ID : 5B3H
Title : The crystal structure of the JACKDAW/IDD10 bound to the heterodimeric SHR-SCR complex
Authors : Hirano, Y.; Suyama, T.; Nakagawa, M.; Hakoshima, T.
Deposited on : 2016-02-29
Resolution : 2.70 Å(reported)

This is a Full wwPDB X-ray Structure Validation Report for a publicly released PDB entry.

We welcome your comments at validation@mail.wwpdb.org

A user guide is available at

<https://www.wwpdb.org/validation/2017/XrayValidationReportHelp>

with specific help available everywhere you see the ⓘ symbol.

The types of validation reports are described at

<http://www.wwpdb.org/validation/2017/FAQs#types>.

The following versions of software and data (see [references ⓘ](#)) were used in the production of this report:

MolProbity : 4.02b-467
Xtriage (Phenix) : 1.13
EDS : 2.36
Percentile statistics : 20191225.v01 (using entries in the PDB archive December 25th 2019)
Refmac : 5.8.0158
CCP4 : 7.0.044 (Gargrove)
Ideal geometry (proteins) : Engh & Huber (2001)
Ideal geometry (DNA, RNA) : Parkinson et al. (1996)
Validation Pipeline (wwPDB-VP) : 2.36

1 Overall quality at a glance

The following experimental techniques were used to determine the structure:

X-RAY DIFFRACTION

The reported resolution of this entry is 2.70 Å.

Percentile scores (ranging between 0-100) for global validation metrics of the entry are shown in the following graphic. The table shows the number of entries on which the scores are based.

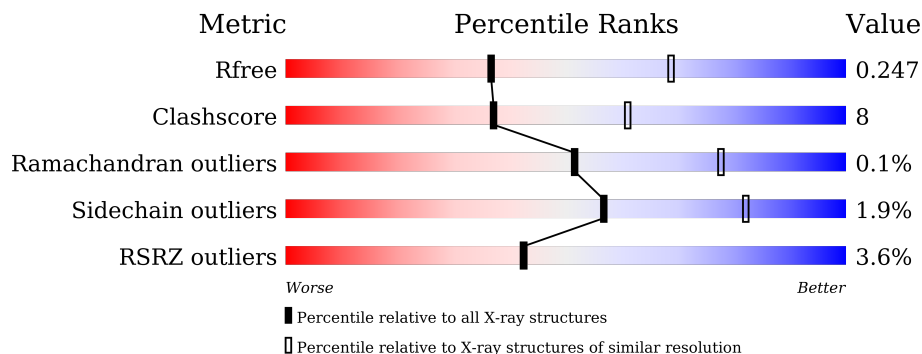

Metric	Whole archive (#Entries)	Similar resolution (#Entries, resolution range(Å))
R_{free}	130704	2808 (2.70-2.70)
Clashscore	141614	3122 (2.70-2.70)
Ramachandran outliers	138981	3069 (2.70-2.70)
Sidechain outliers	138945	3069 (2.70-2.70)
RSRZ outliers	127900	2737 (2.70-2.70)

The table below summarises the geometric issues observed across the polymeric chains and their fit to the electron density. The red, orange, yellow and green segments of the lower bar indicate the fraction of residues that contain outliers for ≥ 3 , 2, 1 and 0 types of geometric quality criteria respectively. A grey segment represents the fraction of residues that are not modelled. The numeric value for each fraction is indicated below the corresponding segment, with a dot representing fractions $\leq 5\%$. The upper red bar (where present) indicates the fraction of residues that have poor fit to the electron density. The numeric value is given above the bar.

Mol	Chain	Length	Quality of chain
1	A	381	
1	D	381	
2	B	421	
2	E	421	
3	C	72	
3	F	72	

2 Entry composition

There are 5 unique types of molecules in this entry. The entry contains 12787 atoms, of which 0 are hydrogens and 0 are deuteriums.

In the tables below, the ZeroOcc column contains the number of atoms modelled with zero occupancy, the AltConf column contains the number of residues with at least one atom in alternate conformation and the Trace column contains the number of residues modelled with at most 2 atoms.

- Molecule 1 is a protein called Protein SCARECROW.

Mol	Chain	Residues	Atoms					ZeroOcc	AltConf	Trace
			Total	C	N	O	S			
1	A	368	2841	1807	483	540	11	0	0	0
1	D	368	2838	1806	483	538	11	0	0	0

There are 4 discrepancies between the modelled and reference sequences:

Chain	Residue	Modelled	Actual	Comment	Reference
A	273	GLY	-	expression tag	UNP Q9M384
A	274	PRO	-	expression tag	UNP Q9M384
D	273	GLY	-	expression tag	UNP Q9M384
D	274	PRO	-	expression tag	UNP Q9M384

- Molecule 2 is a protein called Protein SHORT-ROOT.

Mol	Chain	Residues	Atoms					ZeroOcc	AltConf	Trace
			Total	C	N	O	S			
2	B	406	3155	1979	561	596	19	0	0	0
2	E	401	3115	1960	555	582	18	0	0	0

There are 4 discrepancies between the modelled and reference sequences:

Chain	Residue	Modelled	Actual	Comment	Reference
B	111	GLY	-	expression tag	UNP Q9SZF7
B	233	SER	PRO	see sequence details	UNP Q9SZF7
E	111	GLY	-	expression tag	UNP Q9SZF7
E	233	SER	PRO	see sequence details	UNP Q9SZF7

- Molecule 3 is a protein called Zinc finger protein JACKDAW.

Mol	Chain	Residues	Atoms					ZeroOcc	AltConf	Trace
3	C	54	Total	C	N	O	S	0	0	0
			413	260	73	74	6			
3	F	53	Total	C	N	O	S	0	0	0
			410	259	75	70	6			

There are 4 discrepancies between the modelled and reference sequences:

Chain	Residue	Modelled	Actual	Comment	Reference
C	153	GLY	-	expression tag	UNP Q700D2
C	154	PRO	-	expression tag	UNP Q700D2
F	153	GLY	-	expression tag	UNP Q700D2
F	154	PRO	-	expression tag	UNP Q700D2

- Molecule 4 is ZINC ION (three-letter code: ZN) (formula: Zn).

Mol	Chain	Residues	Atoms		ZeroOcc	AltConf
4	C	2	Total	Zn	0	0
			2	2		
4	F	2	Total	Zn	0	0
			2	2		

- Molecule 5 is water.

Mol	Chain	Residues	Atoms		ZeroOcc	AltConf
5	A	5	Total	O	0	0
			5	5		
5	B	1	Total	O	0	0
			1	1		
5	D	4	Total	O	0	0
			4	4		
5	E	1	Total	O	0	0
			1	1		

3 Residue-property plots [i](#)

These plots are drawn for all protein, RNA, DNA and oligosaccharide chains in the entry. The first graphic for a chain summarises the proportions of the various outlier classes displayed in the second graphic. The second graphic shows the sequence view annotated by issues in geometry and electron density. Residues are color-coded according to the number of geometric quality criteria for which they contain at least one outlier: green = 0, yellow = 1, orange = 2 and red = 3 or more. A red dot above a residue indicates a poor fit to the electron density ($RSRZ > 2$). Stretches of 2 or more consecutive residues without any outlier are shown as a green connector. Residues present in the sample, but not in the model, are shown in grey.

- Molecule 1: Protein SCARECROW

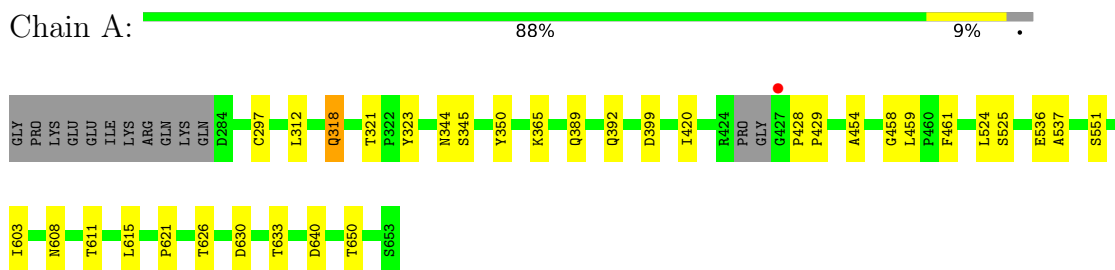

- Molecule 1: Protein SCARECROW

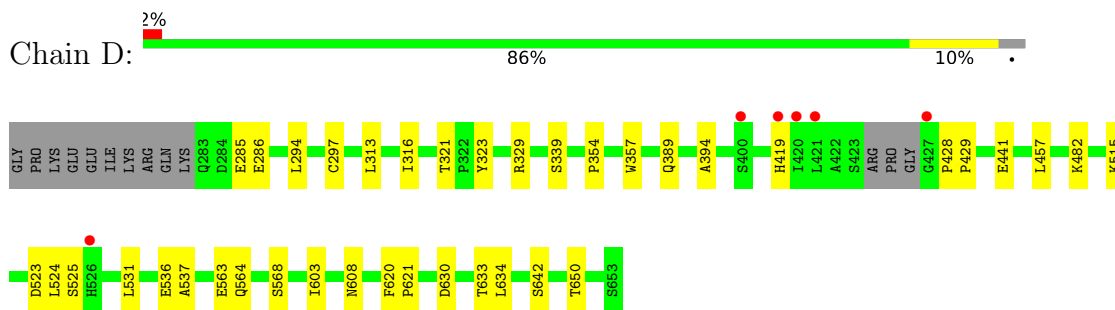

- Molecule 2: Protein SHORT-ROOT

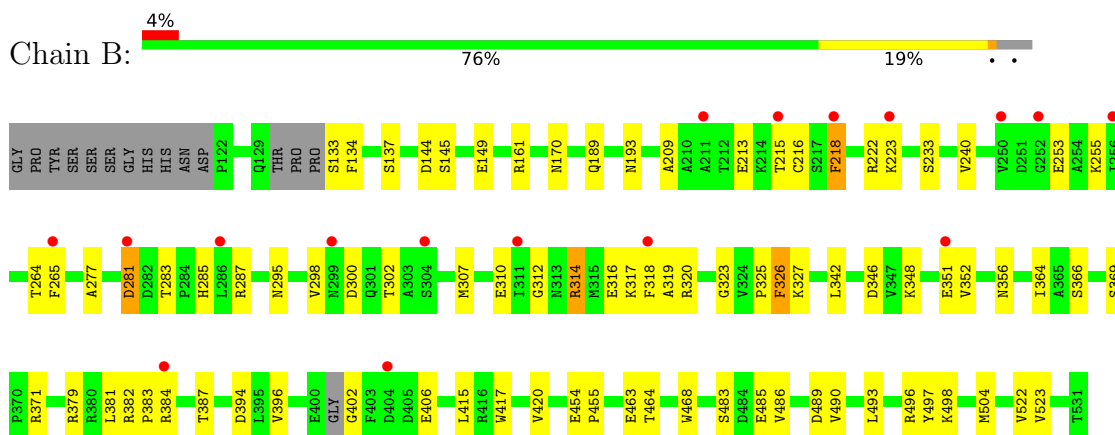

- Molecule 2: Protein SHORT-ROOT

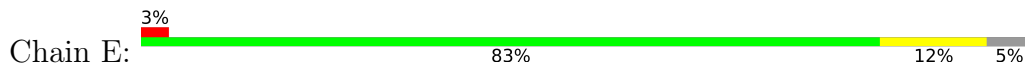

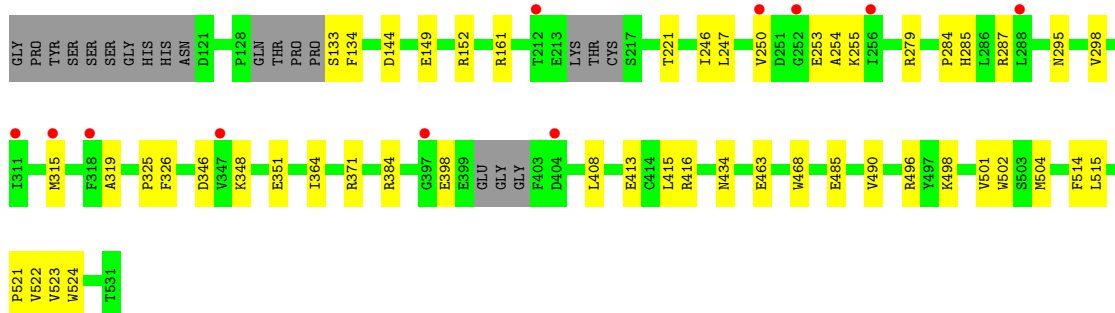

● Molecule 3: Zinc finger protein JACKDAW

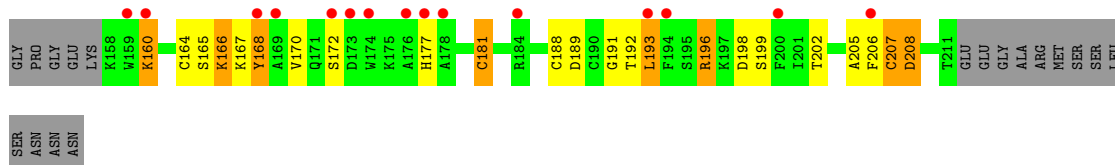
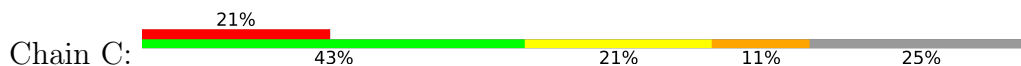

● Molecule 3: Zinc finger protein JACKDAW

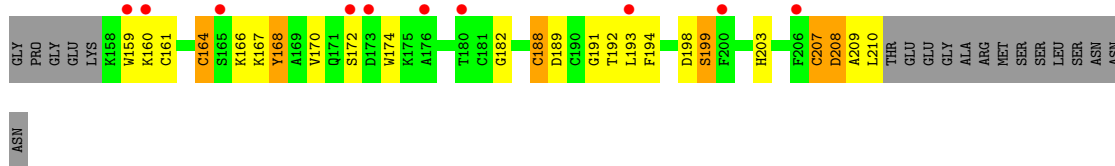

4 Data and refinement statistics

Property	Value	Source
Space group	P 1 21 1	Depositor
Cell constants a, b, c, α , β , γ	57.67Å 203.39Å 88.45Å 90.00° 90.46° 90.00°	Depositor
Resolution (Å)	39.44 – 2.70 43.93 – 2.70	Depositor EDS
% Data completeness (in resolution range)	98.5 (39.44-2.70) 96.7 (43.93-2.70)	Depositor EDS
R_{merge}	(Not available)	Depositor
R_{sym}	(Not available)	Depositor
$\langle I/\sigma(I) \rangle$ ¹	3.37 (at 2.69Å)	Xtrriage
Refinement program	PHENIX 1.9_1692	Depositor
R, R_{free}	0.208 , 0.246 0.211 , 0.247	Depositor DCC
R_{free} test set	2782 reflections (5.07%)	wwPDB-VP
Wilson B-factor (Å ²)	53.4	Xtrriage
Anisotropy	0.038	Xtrriage
Bulk solvent k_{sol} (e/Å ³), B_{sol} (Å ²)	0.31 , 25.4	EDS
L-test for twinning ²	$\langle L \rangle = 0.50$, $\langle L^2 \rangle = 0.34$	Xtrriage
Estimated twinning fraction	0.388 for h,-k,-l	Xtrriage
F_o, F_c correlation	0.94	EDS
Total number of atoms	12787	wwPDB-VP
Average B, all atoms (Å ²)	61.0	wwPDB-VP

Xtrriage's analysis on translational NCS is as follows: *The largest off-origin peak in the Patterson function is 3.75% of the height of the origin peak. No significant pseudotranslation is detected.*

¹Intensities estimated from amplitudes.

²Theoretical values of $\langle |L| \rangle$, $\langle L^2 \rangle$ for acentric reflections are 0.5, 0.333 respectively for untwinned datasets, and 0.375, 0.2 for perfectly twinned datasets.

5 Model quality [i](#)

5.1 Standard geometry [i](#)

Bond lengths and bond angles in the following residue types are not validated in this section:
ZN

The Z score for a bond length (or angle) is the number of standard deviations the observed value is removed from the expected value. A bond length (or angle) with $|Z| > 5$ is considered an outlier worth inspection. RMSZ is the root-mean-square of all Z scores of the bond lengths (or angles).

Mol	Chain	Bond lengths		Bond angles	
		RMSZ	# Z >5	RMSZ	# Z >5
1	A	0.27	0/2902	0.42	0/3936
1	D	0.36	0/2899	0.43	0/3932
2	B	0.52	0/3223	0.52	0/4369
2	E	0.49	0/3182	0.49	0/4312
3	C	0.57	0/423	0.81	1/568 (0.2%)
3	F	0.90	1/420 (0.2%)	1.02	3/563 (0.5%)
All	All	0.45	1/13049 (0.0%)	0.51	4/17680 (0.0%)

All (1) bond length outliers are listed below:

Mol	Chain	Res	Type	Atoms	Z	Observed(Å)	Ideal(Å)
3	F	182	GLY	CA-C	-12.90	1.31	1.51

All (4) bond angle outliers are listed below:

Mol	Chain	Res	Type	Atoms	Z	Observed(°)	Ideal(°)
3	F	182	GLY	CA-C-O	9.74	138.13	120.60
3	F	182	GLY	CA-C-N	-8.98	97.43	117.20
3	F	207	CYS	CA-CB-SG	-7.44	100.61	114.00
3	C	207	CYS	CA-CB-SG	-6.76	101.83	114.00

There are no chirality outliers.

There are no planarity outliers.

5.2 Too-close contacts [i](#)

In the following table, the Non-H and H(model) columns list the number of non-hydrogen atoms and hydrogen atoms in the chain respectively. The H(added) column lists the number of hydrogen atoms added and optimized by MolProbity. The Clashes column lists the number of clashes within

the asymmetric unit, whereas Symm-Clashes lists symmetry-related clashes.

Mol	Chain	Non-H	H(model)	H(added)	Clashes	Symm-Clashes
1	A	2841	0	2794	19	0
1	D	2838	0	2792	26	0
2	B	3155	0	3009	73	0
2	E	3115	0	2985	38	0
3	C	413	0	374	28	0
3	F	410	0	378	25	0
4	C	2	0	0	0	0
4	F	2	0	0	0	0
5	A	5	0	0	0	0
5	B	1	0	0	0	0
5	D	4	0	0	0	0
5	E	1	0	0	0	0
All	All	12787	0	12332	195	0

The all-atom clashscore is defined as the number of clashes found per 1000 atoms (including hydrogen atoms). The all-atom clashscore for this structure is 8.

All (195) close contacts within the same asymmetric unit are listed below, sorted by their clash magnitude.

Atom-1	Atom-2	Interatomic distance (Å)	Clash overlap (Å)
3:F:164:CYS:SG	3:F:166:LYS:HB2	2.06	0.94
2:B:149:GLU:HG3	2:B:161:ARG:HH12	1.37	0.87
2:B:285:HIS:ND1	2:B:325:PRO:O	2.09	0.86
2:E:319:ALA:HB1	2:E:326:PHE:HB2	1.56	0.85
2:E:485:GLU:OE1	3:F:167:LYS:NZ	2.10	0.85
3:F:193:LEU:HD23	3:F:194:PHE:N	1.94	0.83
1:D:321:THR:HG22	1:D:323:TYR:H	1.40	0.83
2:B:485:GLU:OE1	3:C:167:LYS:NZ	2.12	0.81
3:C:188:CYS:SG	3:C:189:ASP:N	2.54	0.81
3:F:209:ALA:O	3:F:210:LEU:HG	1.81	0.81
2:B:287:ARG:HH12	2:B:346:ASP:HB3	1.46	0.80
1:D:525:SER:H	1:D:536:GLU:HG2	1.45	0.80
3:F:159:TRP:CE3	3:F:174:TRP:CZ3	2.71	0.79
2:B:149:GLU:HG3	2:B:161:ARG:NH1	2.00	0.76
2:E:319:ALA:CB	2:E:326:PHE:HB2	2.16	0.74
2:B:281:ASP:N	2:B:281:ASP:OD1	2.20	0.74
2:B:496:ARG:HB3	3:C:196:ARG:HD2	1.70	0.73
1:A:321:THR:HG22	1:A:323:TYR:H	1.55	0.71
3:C:160:LYS:HB2	3:C:167:LYS:HG2	1.72	0.70
2:B:483:SER:OG	2:B:486:VAL:HG23	1.92	0.69

Continued on next page...

Continued from previous page...

Atom-1	Atom-2	Interatomic distance (Å)	Clash overlap (Å)
2:E:149:GLU:HG3	2:E:161:ARG:HH12	1.57	0.69
2:E:319:ALA:HB2	2:E:326:PHE:CD2	2.27	0.68
2:B:233:SER:HB3	2:B:497:TYR:CE2	2.29	0.68
1:D:286:GLU:HA	1:D:286:GLU:OE1	1.94	0.67
2:B:285:HIS:CE1	2:B:326:PHE:HA	2.29	0.67
3:F:159:TRP:CE3	3:F:174:TRP:HZ3	2.12	0.67
3:F:160:LYS:HB2	3:F:167:LYS:HG2	1.77	0.67
3:F:208:ASP:N	3:F:208:ASP:OD1	2.23	0.67
2:E:285:HIS:HA	2:E:325:PRO:HG2	1.76	0.66
2:B:364:ILE:O	2:B:371:ARG:NH2	2.22	0.65
3:F:164:CYS:SG	3:F:166:LYS:HE3	2.37	0.64
2:B:318:PHE:CD2	3:C:205:ALA:HA	2.32	0.64
2:B:149:GLU:CG	2:B:161:ARG:HH12	2.08	0.63
2:B:137:SER:HB3	1:D:531:LEU:HD23	1.79	0.63
2:B:496:ARG:NH1	3:C:198:ASP:OD2	2.30	0.63
2:E:514:PHE:CD2	2:E:521:PRO:HB3	2.33	0.63
3:F:193:LEU:HD23	3:F:193:LEU:C	2.18	0.63
2:B:485:GLU:CD	3:C:167:LYS:NZ	2.52	0.62
2:B:382:ARG:O	2:B:382:ARG:HG2	1.99	0.62
1:D:321:THR:HG21	2:E:434:ASN:OD1	2.00	0.62
2:E:149:GLU:CG	2:E:161:ARG:HH12	2.11	0.62
3:F:198:ASP:OD1	3:F:199:SER:N	2.33	0.61
2:E:315:MET:HG3	2:E:326:PHE:HE2	1.65	0.61
2:E:413:GLU:OE2	2:E:416:ARG:NH2	2.30	0.60
2:E:295:ASN:HB3	2:E:298:VAL:HG23	1.83	0.60
2:B:485:GLU:OE2	3:C:167:LYS:NZ	2.35	0.60
3:F:159:TRP:HB3	3:F:174:TRP:CE3	2.36	0.60
1:A:525:SER:H	1:A:536:GLU:HG2	1.68	0.59
2:B:189:GLN:HE21	2:B:193:ASN:HD21	1.50	0.59
2:B:319:ALA:CB	2:B:326:PHE:CE1	2.84	0.59
1:D:482:LYS:HD2	1:D:482:LYS:H	1.68	0.59
2:B:287:ARG:NH2	2:B:346:ASP:O	2.24	0.58
2:E:319:ALA:CB	2:E:326:PHE:CD2	2.85	0.58
1:A:392:GLN:OE1	1:A:420:ILE:HD13	2.03	0.58
1:D:389:GLN:OE1	1:D:608:ASN:ND2	2.37	0.58
2:E:319:ALA:CB	2:E:326:PHE:CB	2.82	0.57
3:C:198:ASP:OD1	3:C:199:SER:N	2.37	0.57
2:B:287:ARG:NH2	2:B:351:GLU:OE2	2.37	0.57
2:B:522:VAL:HG23	2:B:523:VAL:HG23	1.86	0.57
1:D:524:LEU:HD11	1:D:537:ALA:HA	1.86	0.57
3:F:168:TYR:CD1	3:F:168:TYR:N	2.72	0.57

Continued on next page...

Continued from previous page...

Atom-1	Atom-2	Interatomic distance (Å)	Clash overlap (Å)
1:D:419:HIS:HA	1:D:457:LEU:HD21	1.87	0.57
3:F:188:CYS:SG	3:F:189:ASP:N	2.78	0.57
1:A:389:GLN:HE21	1:A:608:ASN:ND2	2.02	0.56
3:C:168:TYR:N	3:C:168:TYR:CD1	2.72	0.56
3:C:164:CYS:HB2	3:C:166:LYS:HG3	1.87	0.56
2:B:222:ARG:HD2	3:C:206:PHE:HB3	1.88	0.56
3:F:166:LYS:HB3	3:F:168:TYR:HE1	1.71	0.56
2:E:287:ARG:NH2	2:E:346:ASP:O	2.33	0.55
3:F:188:CYS:O	3:F:191:GLY:N	2.39	0.55
1:D:321:THR:HG22	1:D:323:TYR:N	2.18	0.55
1:A:603:ILE:HD11	1:A:650:THR:HB	1.87	0.55
3:C:160:LYS:CB	3:C:167:LYS:HG2	2.35	0.55
3:C:164:CYS:O	3:C:165:SER:HB2	2.06	0.54
2:B:285:HIS:HD1	2:B:325:PRO:C	2.10	0.54
2:B:300:ASP:O	2:B:302:THR:HG23	2.08	0.54
1:A:297:CYS:HA	1:A:312:LEU:HD13	1.89	0.53
2:B:218:PHE:O	2:B:222:ARG:HB2	2.07	0.53
2:B:486:VAL:O	2:B:489:ASP:HB2	2.08	0.53
1:D:603:ILE:HD11	1:D:650:THR:HB	1.90	0.53
2:E:496:ARG:NH1	3:F:198:ASP:OD2	2.41	0.53
2:E:490:VAL:HG11	2:E:504:MET:HG3	1.90	0.53
2:B:144:ASP:HA	2:B:415:LEU:HD21	1.90	0.53
2:B:253:GLU:CG	2:B:384:ARG:HH22	2.22	0.53
2:B:319:ALA:HB2	2:B:326:PHE:CE1	2.44	0.52
1:D:294:LEU:HD22	1:D:316:ILE:HD13	1.90	0.52
3:C:202:THR:O	3:C:206:PHE:HD1	1.92	0.52
2:B:327:LYS:CB	2:B:327:LYS:NZ	2.73	0.52
2:E:325:PRO:HG2	2:E:325:PRO:O	2.10	0.52
2:E:144:ASP:HA	2:E:415:LEU:HD21	1.92	0.51
2:B:310:GLU:O	2:B:314:ARG:HG3	2.11	0.51
2:B:312:GLY:O	2:B:316:GLU:N	2.41	0.51
2:E:348:LYS:NZ	2:E:351:GLU:OE1	2.35	0.50
2:E:463:GLU:HB2	2:E:468:TRP:CE2	2.46	0.50
2:B:213:GLU:O	2:B:213:GLU:HG3	2.10	0.50
1:D:428:PRO:O	1:D:428:PRO:HG2	2.12	0.50
1:D:523:ASP:OD2	1:D:642:SER:OG	2.19	0.50
3:C:208:ASP:OD1	3:C:208:ASP:N	2.44	0.50
1:A:524:LEU:HD11	1:A:537:ALA:HA	1.93	0.49
1:A:345:SER:HA	1:A:350:TYR:HE1	1.78	0.49
2:B:218:PHE:C	2:B:218:PHE:CD1	2.85	0.49
2:B:319:ALA:CB	2:B:326:PHE:CD1	2.96	0.49

Continued on next page...

Continued from previous page...

Atom-1	Atom-2	Interatomic distance (Å)	Clash overlap (Å)
1:D:297:CYS:SG	1:D:313:LEU:HD12	2.53	0.49
2:B:490:VAL:HG11	2:B:504:MET:HG3	1.95	0.48
2:B:463:GLU:HB2	2:B:468:TRP:CE2	2.48	0.48
2:E:315:MET:HG3	2:E:326:PHE:CE2	2.46	0.48
2:B:316:GLU:HA	2:B:326:PHE:CE1	2.49	0.48
2:B:402:GLY:O	2:B:406:GLU:HB2	2.14	0.48
1:A:630:ASP:O	1:A:633:THR:OG1	2.25	0.48
2:B:382:ARG:N	2:B:383:PRO:CD	2.77	0.48
1:D:329:ARG:NH1	1:D:563:GLU:OE1	2.44	0.48
1:D:630:ASP:O	1:D:633:THR:OG1	2.25	0.48
1:A:399:ASP:HA	1:A:429:PRO:HB3	1.95	0.48
3:C:167:LYS:C	3:C:168:TYR:CD1	2.88	0.47
3:F:170:VAL:HG12	3:F:172:SER:H	1.79	0.47
2:B:356:ASN:OD1	2:B:387:THR:OG1	2.27	0.47
2:E:254:ALA:HA	2:E:284:PRO:HB3	1.97	0.47
2:B:218:PHE:HB2	2:B:307:MET:HG3	1.97	0.47
2:B:379:ARG:HG2	2:B:379:ARG:HH11	1.80	0.47
3:F:168:TYR:N	3:F:168:TYR:HD1	2.13	0.46
1:D:285:GLU:HA	1:D:285:GLU:OE2	2.15	0.46
2:B:320:ARG:O	2:B:323:GLY:N	2.40	0.46
2:B:277:ALA:HA	2:B:283:THR:HG21	1.98	0.46
2:E:253:GLU:OE2	2:E:384:ARG:NH1	2.33	0.46
2:E:364:ILE:HB	2:E:371:ARG:HG2	1.97	0.46
3:C:168:TYR:N	3:C:168:TYR:HD1	2.13	0.46
2:E:247:LEU:HB3	2:E:279:ARG:NH2	2.31	0.45
1:A:626:THR:HG21	1:A:640:ASP:H	1.82	0.45
2:B:295:ASN:HB3	2:B:298:VAL:HG12	1.98	0.45
3:C:177:HIS:O	3:C:181:CYS:N	2.50	0.45
2:B:213:GLU:HA	2:B:216:CYS:HB3	1.98	0.45
2:B:366:SER:HB2	2:B:396:VAL:HG22	1.97	0.45
2:B:394:ASP:HB2	2:B:464:THR:HG23	1.98	0.45
2:E:514:PHE:CE1	2:E:524:TRP:CD1	3.05	0.45
3:C:193:LEU:O	3:C:193:LEU:HG	2.16	0.45
3:C:189:ASP:N	3:C:189:ASP:OD1	2.49	0.44
2:E:255:LYS:CB	2:E:351:GLU:HG2	2.48	0.44
2:E:501:VAL:HG23	2:E:502:TRP:CD1	2.52	0.44
2:B:342:LEU:HD13	2:B:381:LEU:HD11	1.99	0.44
3:F:193:LEU:HD23	3:F:194:PHE:CA	2.46	0.44
3:C:164:CYS:CB	3:C:166:LYS:HG3	2.47	0.44
2:B:312:GLY:O	2:B:316:GLU:HG3	2.18	0.44
1:D:313:LEU:HD23	1:D:339:SER:OG	2.18	0.44

Continued on next page...

Continued from previous page...

Atom-1	Atom-2	Interatomic distance (Å)	Clash overlap (Å)
1:A:454:ALA:O	1:A:458:GLY:N	2.51	0.44
2:B:264:THR:O	2:B:265:PHE:HB2	2.18	0.44
2:B:417:TRP:O	2:B:420:VAL:HG12	2.17	0.44
3:F:192:THR:HG22	3:F:193:LEU:N	2.33	0.44
3:C:160:LYS:CA	3:C:167:LYS:HG2	2.48	0.44
2:B:326:PHE:CD1	2:B:326:PHE:O	2.70	0.44
2:E:515:LEU:HB3	2:E:523:VAL:HB	2.00	0.44
1:A:459:LEU:HD23	1:A:461:PHE:HB2	2.00	0.43
2:E:485:GLU:HG2	3:F:160:LYS:HZ2	1.83	0.43
1:D:394:ALA:O	1:D:515:LYS:HE3	2.19	0.43
2:E:514:PHE:HE1	2:E:524:TRP:CD1	2.36	0.43
1:D:441:GLU:H	1:D:441:GLU:CD	2.20	0.43
3:F:193:LEU:C	3:F:193:LEU:CD2	2.85	0.43
3:C:188:CYS:O	3:C:191:GLY:N	2.51	0.43
1:A:344:ASN:OD1	2:B:170:ASN:ND2	2.45	0.43
1:D:428:PRO:HA	1:D:429:PRO:HD3	1.79	0.43
2:E:398:GLU:HG3	2:E:398:GLU:O	2.18	0.43
2:E:498:LYS:HB2	2:E:498:LYS:HE3	1.82	0.43
2:B:326:PHE:CD1	2:B:326:PHE:C	2.92	0.43
1:A:318:GLN:HE22	2:B:209:ALA:C	2.22	0.42
2:B:454:GLU:HA	2:B:455:PRO:HD3	1.91	0.42
2:B:317:LYS:O	2:B:320:ARG:N	2.52	0.42
2:E:522:VAL:HG23	2:E:523:VAL:HG23	2.01	0.42
2:B:319:ALA:HB3	2:B:326:PHE:CE1	2.54	0.42
3:C:170:VAL:HG22	3:C:172:SER:H	1.84	0.42
2:B:233:SER:HB3	2:B:497:TYR:CD2	2.55	0.42
2:B:348:LYS:O	2:B:351:GLU:HG2	2.19	0.42
1:D:354:PRO:HG2	1:D:357:TRP:CG	2.55	0.42
2:B:133:SER:OG	2:B:161:ARG:NH2	2.52	0.42
3:C:196:ARG:HH11	3:C:198:ASP:CG	2.22	0.42
2:B:285:HIS:CE1	2:B:326:PHE:CA	3.01	0.41
2:B:498:LYS:HE3	2:B:498:LYS:HB2	1.82	0.41
2:B:134:PHE:CE1	2:B:149:GLU:HG2	2.56	0.41
1:A:551:SER:HB3	1:A:621:PRO:HG2	2.03	0.41
2:B:134:PHE:HE1	2:B:149:GLU:HG2	1.85	0.41
2:E:246:ILE:O	2:E:250:VAL:HG22	2.21	0.41
1:A:365:LYS:HE2	1:A:365:LYS:HB2	1.82	0.41
1:D:564:GLN:O	1:D:568:SER:OG	2.30	0.41
2:E:408:LEU:HD23	2:E:408:LEU:HA	1.91	0.41
1:A:428:PRO:O	1:A:428:PRO:HG2	2.20	0.41
2:E:152:ARG:HA	2:E:408:LEU:HD21	2.02	0.41

Continued on next page...

Continued from previous page...

Atom-1	Atom-2	Interatomic distance (Å)	Clash overlap (Å)
2:B:255:LYS:O	2:B:352:VAL:HG12	2.21	0.41
2:B:287:ARG:HH21	2:B:351:GLU:CD	2.22	0.41
2:B:145:SER:O	2:B:149:GLU:HB2	2.20	0.41
3:C:188:CYS:O	3:C:191:GLY:HA2	2.21	0.41
1:A:611:THR:O	1:A:615:LEU:HG	2.22	0.40
1:D:634:LEU:HD23	1:D:634:LEU:HA	1.90	0.40
3:C:160:LYS:HA	3:C:167:LYS:HG2	2.03	0.40
3:F:160:LYS:HA	3:F:167:LYS:HA	2.04	0.40
1:D:620:PHE:HA	1:D:621:PRO:HD3	1.92	0.40
2:B:240:VAL:HG21	2:B:493:LEU:HD22	2.04	0.40
3:F:203:HIS:CD2	3:F:203:HIS:C	2.94	0.40

There are no symmetry-related clashes.

5.3 Torsion angles [i](#)

5.3.1 Protein backbone [i](#)

In the following table, the Percentiles column shows the percent Ramachandran outliers of the chain as a percentile score with respect to all X-ray entries followed by that with respect to entries of similar resolution.

The Analysed column shows the number of residues for which the backbone conformation was analysed, and the total number of residues.

Mol	Chain	Analysed	Favoured	Allowed	Outliers	Percentiles	
1	A	364/381 (96%)	356 (98%)	8 (2%)	0	100	100
1	D	364/381 (96%)	352 (97%)	12 (3%)	0	100	100
2	B	400/421 (95%)	388 (97%)	11 (3%)	1 (0%)	41	66
2	E	393/421 (93%)	386 (98%)	7 (2%)	0	100	100
3	C	52/72 (72%)	49 (94%)	3 (6%)	0	100	100
3	F	51/72 (71%)	50 (98%)	1 (2%)	0	100	100
All	All	1624/1748 (93%)	1581 (97%)	42 (3%)	1 (0%)	51	78

All (1) Ramachandran outliers are listed below:

Mol	Chain	Res	Type
2	B	369	SER

5.3.2 Protein sidechains [i](#)

In the following table, the Percentiles column shows the percent sidechain outliers of the chain as a percentile score with respect to all X-ray entries followed by that with respect to entries of similar resolution.

The Analysed column shows the number of residues for which the sidechain conformation was analysed, and the total number of residues.

Mol	Chain	Analysed	Rotameric	Outliers	Percentiles	
1	A	303/317 (96%)	302 (100%)	1 (0%)	92	98
1	D	302/317 (95%)	302 (100%)	0	100	100
2	B	327/354 (92%)	321 (98%)	6 (2%)	59	83
2	E	322/354 (91%)	319 (99%)	3 (1%)	78	92
3	C	41/61 (67%)	32 (78%)	9 (22%)	1	2
3	F	40/61 (66%)	33 (82%)	7 (18%)	2	4
All	All	1335/1464 (91%)	1309 (98%)	26 (2%)	57	82

All (26) residues with a non-rotameric sidechain are listed below:

Mol	Chain	Res	Type
1	A	318	GLN
2	B	215	THR
2	B	218	PHE
2	B	223	LYS
2	B	281	ASP
2	B	314	ARG
2	B	326	PHE
2	E	133	SER
2	E	134	PHE
2	E	221	THR
3	C	160	LYS
3	C	166	LYS
3	C	168	TYR
3	C	181	CYS
3	C	192	THR
3	C	193	LEU
3	C	196	ARG
3	C	207	CYS
3	C	208	ASP
3	F	161	CYS
3	F	164	CYS
3	F	168	TYR

Continued on next page...

Continued from previous page...

Mol	Chain	Res	Type
3	F	188	CYS
3	F	199	SER
3	F	207	CYS
3	F	208	ASP

Sometimes sidechains can be flipped to improve hydrogen bonding and reduce clashes. All (9) such sidechains are listed below:

Mol	Chain	Res	Type
1	A	318	GLN
1	A	526	HIS
1	A	565	GLN
1	A	608	ASN
2	B	189	GLN
2	B	434	ASN
1	D	608	ASN
2	E	164	GLN
3	F	203	HIS

5.3.3 RNA [i](#)

There are no RNA molecules in this entry.

5.4 Non-standard residues in protein, DNA, RNA chains [i](#)

There are no non-standard protein/DNA/RNA residues in this entry.

5.5 Carbohydrates [i](#)

There are no monosaccharides in this entry.

5.6 Ligand geometry [i](#)

Of 4 ligands modelled in this entry, 4 are monoatomic - leaving 0 for Mogul analysis.

There are no bond length outliers.

There are no bond angle outliers.

There are no chirality outliers.

There are no torsion outliers.

There are no ring outliers.

No monomer is involved in short contacts.

5.7 Other polymers

There are no such residues in this entry.

5.8 Polymer linkage issues

There are no chain breaks in this entry.

6 Fit of model and data

6.1 Protein, DNA and RNA chains

In the following table, the column labelled ‘#RSRZ > 2’ contains the number (and percentage) of RSRZ outliers, followed by percent RSRZ outliers for the chain as percentile scores relative to all X-ray entries and entries of similar resolution. The OWAB column contains the minimum, median, 95th percentile and maximum values of the occupancy-weighted average B-factor per residue. The column labelled ‘Q < 0.9’ lists the number of (and percentage) of residues with an average occupancy less than 0.9.

Mol	Chain	Analysed	<RSRZ>	#RSRZ>2	OWAB(Å ²)	Q<0.9
1	A	368/381 (96%)	0.13	1 (0%) 94 95	32, 52, 83, 115	0
1	D	368/381 (96%)	0.18	6 (1%) 72 74	32, 53, 85, 107	0
2	B	406/421 (96%)	0.11	17 (4%) 36 35	29, 57, 101, 127	0
2	E	401/421 (95%)	0.14	11 (2%) 54 55	29, 55, 95, 120	0
3	C	54/72 (75%)	1.28	15 (27%) 0 0	67, 112, 136, 139	0
3	F	53/72 (73%)	1.02	10 (18%) 1 0	73, 106, 128, 138	0
All	All	1650/1748 (94%)	0.21	60 (3%) 42 42	29, 56, 107, 139	0

All (60) RSRZ outliers are listed below:

Mol	Chain	Res	Type	RSRZ
3	C	176	ALA	6.0
3	F	159	TRP	5.2
3	F	172	SER	5.2
3	C	193	LEU	4.8
3	F	180	THR	4.5
3	C	194	PHE	4.2
1	D	421	LEU	4.0
3	F	193	LEU	4.0
1	D	427	GLY	3.7
3	C	160	LYS	3.7
3	C	169	ALA	3.5
2	B	281	ASP	3.4
2	E	252	GLY	3.4
2	E	397	GLY	3.4
2	B	304	SER	3.3
2	B	404	ASP	3.3
2	B	250	VAL	3.1
2	E	318	PHE	3.1
3	F	200	PHE	3.1

Continued on next page...

Continued from previous page...

Mol	Chain	Res	Type	RSRZ
3	C	178	ALA	3.0
3	C	159	TRP	3.0
3	C	174	TRP	2.8
2	B	211	ALA	2.7
3	F	176	ALA	2.7
3	F	206	PHE	2.7
2	B	223	LYS	2.6
2	E	212	THR	2.5
2	E	311	ILE	2.5
2	B	299	ASN	2.5
2	B	351	GLU	2.4
2	B	384	ARG	2.4
1	D	419	HIS	2.4
2	B	218	PHE	2.4
2	B	318	PHE	2.4
2	B	265	PHE	2.4
3	C	172	SER	2.3
3	C	206	PHE	2.3
2	E	347	VAL	2.3
3	F	173	ASP	2.3
3	F	160	LYS	2.3
1	A	427	GLY	2.2
1	D	420	ILE	2.2
3	C	173	ASP	2.2
1	D	400	SER	2.2
3	F	165	SER	2.2
3	C	168	TYR	2.2
2	B	311	ILE	2.2
2	E	315	MET	2.2
1	D	526	HIS	2.1
2	B	286	LEU	2.1
3	C	177	HIS	2.1
2	E	256	ILE	2.1
2	B	215	THR	2.1
2	E	404	ASP	2.1
2	E	250	VAL	2.1
2	B	252	GLY	2.1
3	C	184	ARG	2.0
2	E	288	LEU	2.0
2	B	256	ILE	2.0
3	C	200	PHE	2.0

6.2 Non-standard residues in protein, DNA, RNA chains [i](#)

There are no non-standard protein/DNA/RNA residues in this entry.

6.3 Carbohydrates [i](#)

There are no monosaccharides in this entry.

6.4 Ligands [i](#)

In the following table, the Atoms column lists the number of modelled atoms in the group and the number defined in the chemical component dictionary. The B-factors column lists the minimum, median, 95th percentile and maximum values of B factors of atoms in the group. The column labelled 'Q< 0.9' lists the number of atoms with occupancy less than 0.9.

Mol	Type	Chain	Res	Atoms	RSCC	RSR	B-factors(Å ²)	Q<0.9
4	ZN	C	302	1/1	0.60	0.09	164,164,164,164	0
4	ZN	C	301	1/1	0.68	0.14	119,119,119,119	0
4	ZN	F	301	1/1	0.87	0.09	101,101,101,101	0
4	ZN	F	302	1/1	0.93	0.09	153,153,153,153	0

6.5 Other polymers [i](#)

There are no such residues in this entry.