



Full wwPDB EM Validation Report ⓘ

Dec 12, 2022 – 12:26 am GMT

PDB ID : 5A1V
EMDB ID : EMD-2986
Title : The structure of the COPI coat linkage I
Authors : Dodonova, S.O.; Diestelkoetter-Bachert, P.; von Appen, A.; Hagen, W.J.H.; Beck, R.; Beck, M.; Wieland, F.; Briggs, J.A.G.
Deposited on : 2015-05-06
Resolution : 21.00 Å(reported)

This is a Full wwPDB EM Validation Report for a publicly released PDB entry.

We welcome your comments at validation@mail.wwpdb.org

A user guide is available at

<https://www.wwpdb.org/validation/2017/EMValidationReportHelp>

with specific help available everywhere you see the ⓘ symbol.

The types of validation reports are described at

<http://www.wwpdb.org/validation/2017/FAQs#types>.

The following versions of software and data (see [references ⓘ](#)) were used in the production of this report:

EMDB validation analysis : 0.0.1.dev43
MolProbity : 4.02b-467
Percentile statistics : 20191225.v01 (using entries in the PDB archive December 25th 2019)
MapQ : 1.9.9
Ideal geometry (proteins) : Engh & Huber (2001)
Ideal geometry (DNA, RNA) : Parkinson et al. (1996)
Validation Pipeline (wwPDB-VP) : 2.31.3

1 Overall quality at a glance i

The following experimental techniques were used to determine the structure:
ELECTRON MICROSCOPY

The reported resolution of this entry is 21.00 Å.

Percentile scores (ranging between 0-100) for global validation metrics of the entry are shown in the following graphic. The table shows the number of entries on which the scores are based.

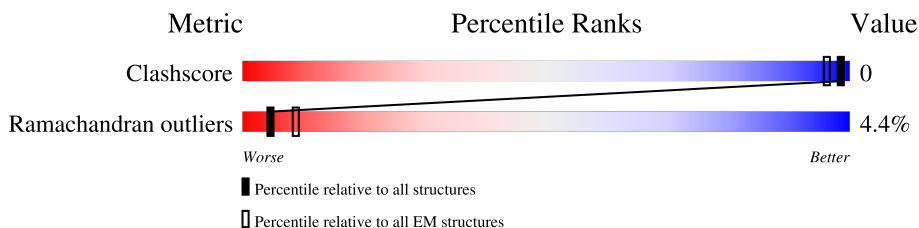

Metric	Whole archive (#Entries)	EM structures (#Entries)
Clashscore	158937	4297
Ramachandran outliers	154571	4023

The table below summarises the geometric issues observed across the polymeric chains and their fit to the map. The red, orange, yellow and green segments of the bar indicate the fraction of residues that contain outliers for ≥ 3 , 2, 1 and 0 types of geometric quality criteria respectively. A grey segment represents the fraction of residues that are not modelled. The numeric value for each fraction is indicated below the corresponding segment, with a dot representing fractions $\leq 5\%$. The upper red bar (where present) indicates the fraction of residues that have poor fit to the EM map (all-atom inclusion $< 40\%$). The numeric value is given above the bar.

Mol	Chain	Length	Quality of chain
1	A	181	14% 88% 12%
1	B	181	42% 88% 12%
1	I	181	17% 88% 12%
1	J	181	23% 88% 12%
1	R	181	12% 88% 12%
1	S	181	20% 88% 12%
2	C	1262	16% 59% 5% 36%
2	K	1262	12% 84% 5% 11%
2	T	1262	13% 84% 5% 11%

Continued on next page...

Continued from previous page...

Mol	Chain	Length	Quality of chain
3	D	905	18% 80% 9% 11%
3	L	905	14% 80% 9% 11%
3	U	905	10% 80% 9% 11%
4	E	874	11% 88% 5% 6%
4	M	874	10% 88% 5% 6%
4	V	874	8% 88% 5% 6%
5	F	177	13% 75% • 21%
5	N	177	10% 75% • 21%
5	W	177	5% 75% • 21%
6	G	968	20% 73% 10% • 16%
6	O	968	14% 73% 10% • 16%
6	X	968	12% 73% 10% • 16%
7	H	511	9% 25% • 74%
7	P	511	• 25% • 74%
7	Y	511	• 25% • 74%
8	Q	308	33% 93% • 5%
8	Z	308	28% 93% • 5%

2 Entry composition i

There are 8 unique types of molecules in this entry. The entry contains 50958 atoms, of which 0 are hydrogens and 0 are deuteriums.

In the tables below, the AltConf column contains the number of residues with at least one atom in alternate conformation and the Trace column contains the number of residues modelled with at most 2 atoms.

- Molecule 1 is a protein called ADP-RIBOSYLATION FACTOR 1.

Mol	Chain	Residues	Atoms				AltConf	Trace
			Total	C	N	O		
1	A	159	636	318	159	159	0	0
1	B	159	636	318	159	159	0	0
1	I	159	636	318	159	159	0	0
1	J	159	636	318	159	159	0	0
1	R	159	636	318	159	159	0	0
1	S	159	636	318	159	159	0	0

- Molecule 2 is a protein called COATOMER SUBUNIT ALPHA.

Mol	Chain	Residues	Atoms				AltConf	Trace
			Total	C	N	O		
2	C	813	3251	1626	813	812	0	0
2	K	1126	4503	2252	1126	1125	0	0
2	T	1126	4503	2252	1126	1125	0	0

There are 114 discrepancies between the modelled and reference sequences:

Chain	Residue	Modelled	Actual	Comment	Reference
C	1225	LEU	-	expression tag	UNP Q8CIE6
C	1226	GLU	-	expression tag	UNP Q8CIE6
C	1227	VAL	-	expression tag	UNP Q8CIE6
C	1228	LEU	-	expression tag	UNP Q8CIE6
C	1229	PHE	-	expression tag	UNP Q8CIE6
C	1230	GLN	-	expression tag	UNP Q8CIE6
C	1231	GLY	-	expression tag	UNP Q8CIE6

Continued on next page...

Continued from previous page...

Chain	Residue	Modelled	Actual	Comment	Reference
C	1232	PRO	-	expression tag	UNP Q8CIE6
C	1233	SER	-	expression tag	UNP Q8CIE6
C	1234	ALA	-	expression tag	UNP Q8CIE6
C	1235	TRP	-	expression tag	UNP Q8CIE6
C	1236	SER	-	expression tag	UNP Q8CIE6
C	1237	HIS	-	expression tag	UNP Q8CIE6
C	1238	PRO	-	expression tag	UNP Q8CIE6
C	1239	GLN	-	expression tag	UNP Q8CIE6
C	1240	PHE	-	expression tag	UNP Q8CIE6
C	1241	GLU	-	expression tag	UNP Q8CIE6
C	1242	LYS	-	expression tag	UNP Q8CIE6
C	1243	GLY	-	expression tag	UNP Q8CIE6
C	1244	GLY	-	expression tag	UNP Q8CIE6
C	1245	GLY	-	expression tag	UNP Q8CIE6
C	1246	SER	-	expression tag	UNP Q8CIE6
C	1247	GLY	-	expression tag	UNP Q8CIE6
C	1248	GLY	-	expression tag	UNP Q8CIE6
C	1249	GLY	-	expression tag	UNP Q8CIE6
C	1250	SER	-	expression tag	UNP Q8CIE6
C	1251	GLY	-	expression tag	UNP Q8CIE6
C	1252	GLY	-	expression tag	UNP Q8CIE6
C	1253	SER	-	expression tag	UNP Q8CIE6
C	1254	ALA	-	expression tag	UNP Q8CIE6
C	1255	TRP	-	expression tag	UNP Q8CIE6
C	1256	SER	-	expression tag	UNP Q8CIE6
C	1257	HIS	-	expression tag	UNP Q8CIE6
C	1258	PRO	-	expression tag	UNP Q8CIE6
C	1259	GLN	-	expression tag	UNP Q8CIE6
C	1260	PHE	-	expression tag	UNP Q8CIE6
C	1261	GLU	-	expression tag	UNP Q8CIE6
C	1262	LYS	-	expression tag	UNP Q8CIE6
K	1225	LEU	-	expression tag	UNP Q8CIE6
K	1226	GLU	-	expression tag	UNP Q8CIE6
K	1227	VAL	-	expression tag	UNP Q8CIE6
K	1228	LEU	-	expression tag	UNP Q8CIE6
K	1229	PHE	-	expression tag	UNP Q8CIE6
K	1230	GLN	-	expression tag	UNP Q8CIE6
K	1231	GLY	-	expression tag	UNP Q8CIE6
K	1232	PRO	-	expression tag	UNP Q8CIE6
K	1233	SER	-	expression tag	UNP Q8CIE6
K	1234	ALA	-	expression tag	UNP Q8CIE6
K	1235	TRP	-	expression tag	UNP Q8CIE6

Continued on next page...

Continued from previous page...

Chain	Residue	Modelled	Actual	Comment	Reference
K	1236	SER	-	expression tag	UNP Q8CIE6
K	1237	HIS	-	expression tag	UNP Q8CIE6
K	1238	PRO	-	expression tag	UNP Q8CIE6
K	1239	GLN	-	expression tag	UNP Q8CIE6
K	1240	PHE	-	expression tag	UNP Q8CIE6
K	1241	GLU	-	expression tag	UNP Q8CIE6
K	1242	LYS	-	expression tag	UNP Q8CIE6
K	1243	GLY	-	expression tag	UNP Q8CIE6
K	1244	GLY	-	expression tag	UNP Q8CIE6
K	1245	GLY	-	expression tag	UNP Q8CIE6
K	1246	SER	-	expression tag	UNP Q8CIE6
K	1247	GLY	-	expression tag	UNP Q8CIE6
K	1248	GLY	-	expression tag	UNP Q8CIE6
K	1249	GLY	-	expression tag	UNP Q8CIE6
K	1250	SER	-	expression tag	UNP Q8CIE6
K	1251	GLY	-	expression tag	UNP Q8CIE6
K	1252	GLY	-	expression tag	UNP Q8CIE6
K	1253	SER	-	expression tag	UNP Q8CIE6
K	1254	ALA	-	expression tag	UNP Q8CIE6
K	1255	TRP	-	expression tag	UNP Q8CIE6
K	1256	SER	-	expression tag	UNP Q8CIE6
K	1257	HIS	-	expression tag	UNP Q8CIE6
K	1258	PRO	-	expression tag	UNP Q8CIE6
K	1259	GLN	-	expression tag	UNP Q8CIE6
K	1260	PHE	-	expression tag	UNP Q8CIE6
K	1261	GLU	-	expression tag	UNP Q8CIE6
K	1262	LYS	-	expression tag	UNP Q8CIE6
T	1225	LEU	-	expression tag	UNP Q8CIE6
T	1226	GLU	-	expression tag	UNP Q8CIE6
T	1227	VAL	-	expression tag	UNP Q8CIE6
T	1228	LEU	-	expression tag	UNP Q8CIE6
T	1229	PHE	-	expression tag	UNP Q8CIE6
T	1230	GLN	-	expression tag	UNP Q8CIE6
T	1231	GLY	-	expression tag	UNP Q8CIE6
T	1232	PRO	-	expression tag	UNP Q8CIE6
T	1233	SER	-	expression tag	UNP Q8CIE6
T	1234	ALA	-	expression tag	UNP Q8CIE6
T	1235	TRP	-	expression tag	UNP Q8CIE6
T	1236	SER	-	expression tag	UNP Q8CIE6
T	1237	HIS	-	expression tag	UNP Q8CIE6
T	1238	PRO	-	expression tag	UNP Q8CIE6
T	1239	GLN	-	expression tag	UNP Q8CIE6

Continued on next page...

Continued from previous page...

Chain	Residue	Modelled	Actual	Comment	Reference
T	1240	PHE	-	expression tag	UNP Q8CIE6
T	1241	GLU	-	expression tag	UNP Q8CIE6
T	1242	LYS	-	expression tag	UNP Q8CIE6
T	1243	GLY	-	expression tag	UNP Q8CIE6
T	1244	GLY	-	expression tag	UNP Q8CIE6
T	1245	GLY	-	expression tag	UNP Q8CIE6
T	1246	SER	-	expression tag	UNP Q8CIE6
T	1247	GLY	-	expression tag	UNP Q8CIE6
T	1248	GLY	-	expression tag	UNP Q8CIE6
T	1249	GLY	-	expression tag	UNP Q8CIE6
T	1250	SER	-	expression tag	UNP Q8CIE6
T	1251	GLY	-	expression tag	UNP Q8CIE6
T	1252	GLY	-	expression tag	UNP Q8CIE6
T	1253	SER	-	expression tag	UNP Q8CIE6
T	1254	ALA	-	expression tag	UNP Q8CIE6
T	1255	TRP	-	expression tag	UNP Q8CIE6
T	1256	SER	-	expression tag	UNP Q8CIE6
T	1257	HIS	-	expression tag	UNP Q8CIE6
T	1258	PRO	-	expression tag	UNP Q8CIE6
T	1259	GLN	-	expression tag	UNP Q8CIE6
T	1260	PHE	-	expression tag	UNP Q8CIE6
T	1261	GLU	-	expression tag	UNP Q8CIE6
T	1262	LYS	-	expression tag	UNP Q8CIE6

- Molecule 3 is a protein called COATOMER SUBUNIT BETA.

Mol	Chain	Residues	Atoms				AltConf	Trace
3	D	803	Total	C	N	O	0	0
			3211	1606	803	802		
3	L	803	Total	C	N	O	0	0
			3211	1606	803	802		
3	U	803	Total	C	N	O	0	0
			3211	1606	803	802		

- Molecule 4 is a protein called COATOMER SUBUNIT GAMMA-1.

Mol	Chain	Residues	Atoms				AltConf	Trace
4	E	824	Total	C	N	O	0	0
			3294	1648	824	822		
4	M	824	Total	C	N	O	0	0
			3294	1648	824	822		

Continued on next page...

Continued from previous page...

Mol	Chain	Residues	Atoms				AltConf	Trace
4	V	824	Total	C	N	O	0	0
			3294	1648	824	822		

- Molecule 5 is a protein called COATOMER SUBUNIT ZETA-1.

Mol	Chain	Residues	Atoms				AltConf	Trace
5	F	139	Total	C	N	O	0	0
			555	278	139	138		
5	N	139	Total	C	N	O	0	0
			555	278	139	138		
5	W	139	Total	C	N	O	0	0
			555	278	139	138		

- Molecule 6 is a protein called COATOMER SUBUNIT BETA'.

Mol	Chain	Residues	Atoms				AltConf	Trace
6	G	813	Total	C	N	O	0	0
			3250	1626	813	811		
6	O	813	Total	C	N	O	0	0
			3250	1626	813	811		
6	X	813	Total	C	N	O	0	0
			3250	1626	813	811		

There are 45 discrepancies between the modelled and reference sequences:

Chain	Residue	Modelled	Actual	Comment	Reference
G	-14	MET	-	expression tag	UNP Q9JIF7
G	-13	HIS	-	expression tag	UNP Q9JIF7
G	-12	HIS	-	expression tag	UNP Q9JIF7
G	-11	HIS	-	expression tag	UNP Q9JIF7
G	-10	HIS	-	expression tag	UNP Q9JIF7
G	-9	HIS	-	expression tag	UNP Q9JIF7
G	-8	HIS	-	expression tag	UNP Q9JIF7
G	-7	GLU	-	expression tag	UNP Q9JIF7
G	-6	ASN	-	expression tag	UNP Q9JIF7
G	-5	LEU	-	expression tag	UNP Q9JIF7
G	-4	TYR	-	expression tag	UNP Q9JIF7
G	-3	PHE	-	expression tag	UNP Q9JIF7
G	-2	GLN	-	expression tag	UNP Q9JIF7
G	-1	GLY	-	expression tag	UNP Q9JIF7
G	0	HIS	-	expression tag	UNP Q9JIF7
O	-14	MET	-	expression tag	UNP Q9JIF7

Continued on next page...

Continued from previous page...

Chain	Residue	Modelled	Actual	Comment	Reference
O	-13	HIS	-	expression tag	UNP Q9JIF7
O	-12	HIS	-	expression tag	UNP Q9JIF7
O	-11	HIS	-	expression tag	UNP Q9JIF7
O	-10	HIS	-	expression tag	UNP Q9JIF7
O	-9	HIS	-	expression tag	UNP Q9JIF7
O	-8	HIS	-	expression tag	UNP Q9JIF7
O	-7	GLU	-	expression tag	UNP Q9JIF7
O	-6	ASN	-	expression tag	UNP Q9JIF7
O	-5	LEU	-	expression tag	UNP Q9JIF7
O	-4	TYR	-	expression tag	UNP Q9JIF7
O	-3	PHE	-	expression tag	UNP Q9JIF7
O	-2	GLN	-	expression tag	UNP Q9JIF7
O	-1	GLY	-	expression tag	UNP Q9JIF7
O	0	HIS	-	expression tag	UNP Q9JIF7
X	-14	MET	-	expression tag	UNP Q9JIF7
X	-13	HIS	-	expression tag	UNP Q9JIF7
X	-12	HIS	-	expression tag	UNP Q9JIF7
X	-11	HIS	-	expression tag	UNP Q9JIF7
X	-10	HIS	-	expression tag	UNP Q9JIF7
X	-9	HIS	-	expression tag	UNP Q9JIF7
X	-8	HIS	-	expression tag	UNP Q9JIF7
X	-7	GLU	-	expression tag	UNP Q9JIF7
X	-6	ASN	-	expression tag	UNP Q9JIF7
X	-5	LEU	-	expression tag	UNP Q9JIF7
X	-4	TYR	-	expression tag	UNP Q9JIF7
X	-3	PHE	-	expression tag	UNP Q9JIF7
X	-2	GLN	-	expression tag	UNP Q9JIF7
X	-1	GLY	-	expression tag	UNP Q9JIF7
X	0	HIS	-	expression tag	UNP Q9JIF7

- Molecule 7 is a protein called COATOMER SUBUNIT DELTA.

Mol	Chain	Residues	Atoms			AltConf	Trace	
7	H	135	Total	C	N	O	0	0
			539	270	135	134		
7	P	135	Total	C	N	O	0	0
			539	270	135	134		
7	Y	135	Total	C	N	O	0	0
			539	270	135	134		

- Molecule 8 is a protein called COATOMER SUBUNIT EPSILON.

Mol	Chain	Residues	Atoms				AltConf	Trace
			Total	C	N	O		
8	Q	292	1169	584	292	293	0	0
8	Z	292	1169	584	292	293	0	0

3 Residue-property plots [i](#)

These plots are drawn for all protein, RNA, DNA and oligosaccharide chains in the entry. The first graphic for a chain summarises the proportions of the various outlier classes displayed in the second graphic. The second graphic shows the sequence view annotated by issues in geometry and atom inclusion in map density. Residues are color-coded according to the number of geometric quality criteria for which they contain at least one outlier: green = 0, yellow = 1, orange = 2 and red = 3 or more. A red diamond above a residue indicates a poor fit to the EM map for this residue (all-atom inclusion < 40%). Stretches of 2 or more consecutive residues without any outlier are shown as a green connector. Residues present in the sample, but not in the model, are shown in grey.

- Molecule 1: ADP-RIBOSYLATION FACTOR 1

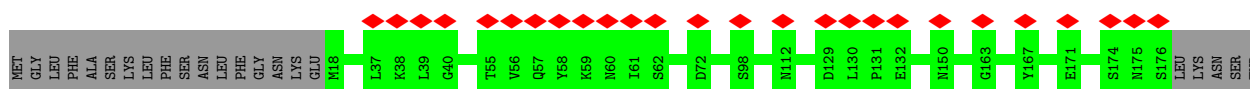
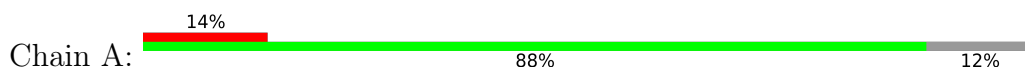

- Molecule 1: ADP-RIBOSYLATION FACTOR 1

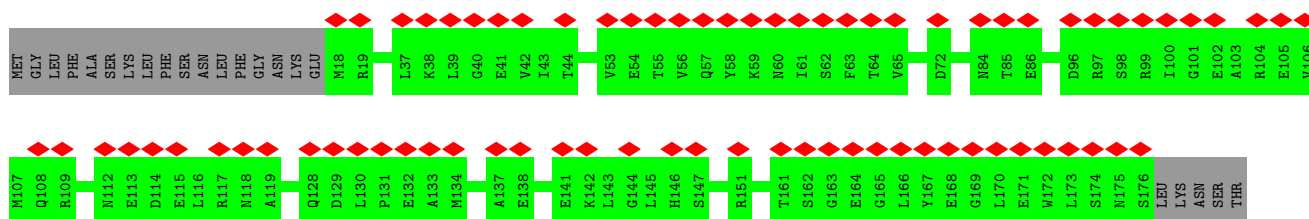
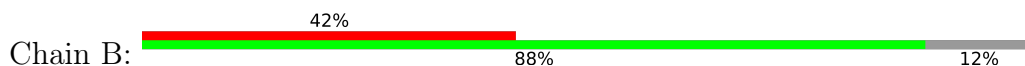

- Molecule 1: ADP-RIBOSYLATION FACTOR 1

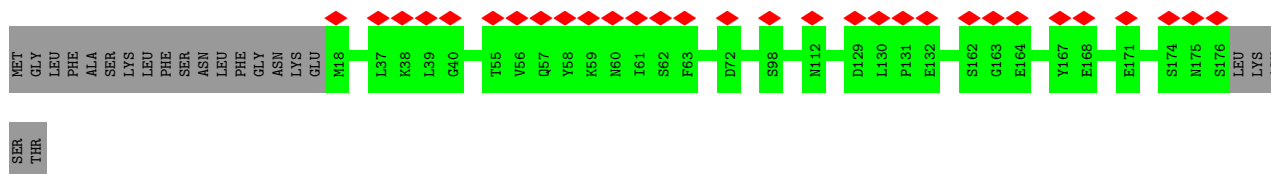
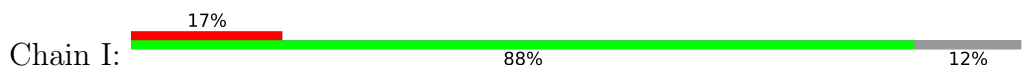

- Molecule 1: ADP-RIBOSYLATION FACTOR 1

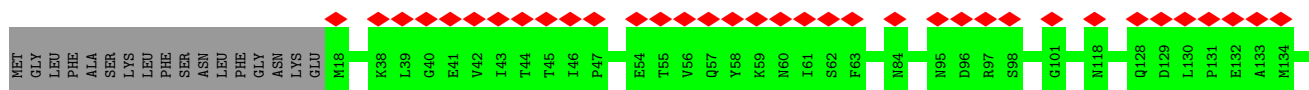
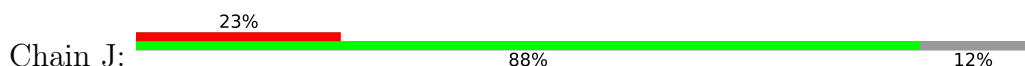

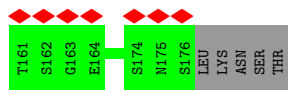

• Molecule 1: ADP-RIBOSYLATION FACTOR 1

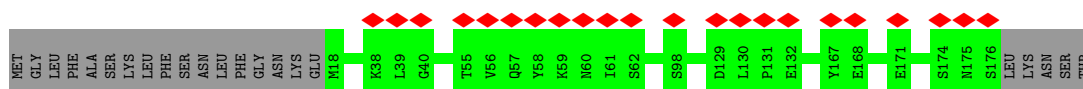
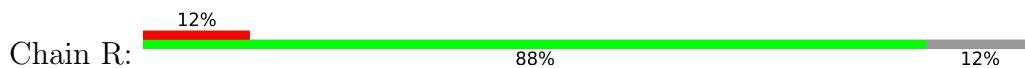

• Molecule 1: ADP-RIBOSYLATION FACTOR 1

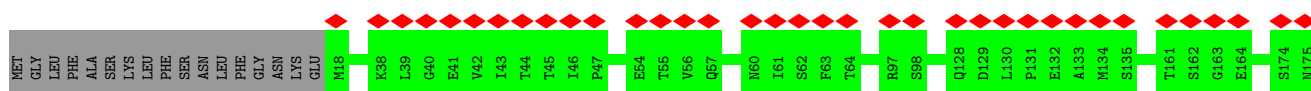
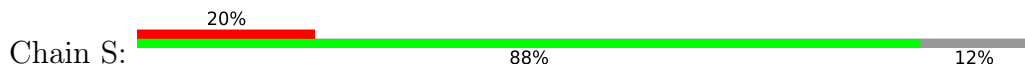

• Molecule 2: COATOMER SUBUNIT ALPHA

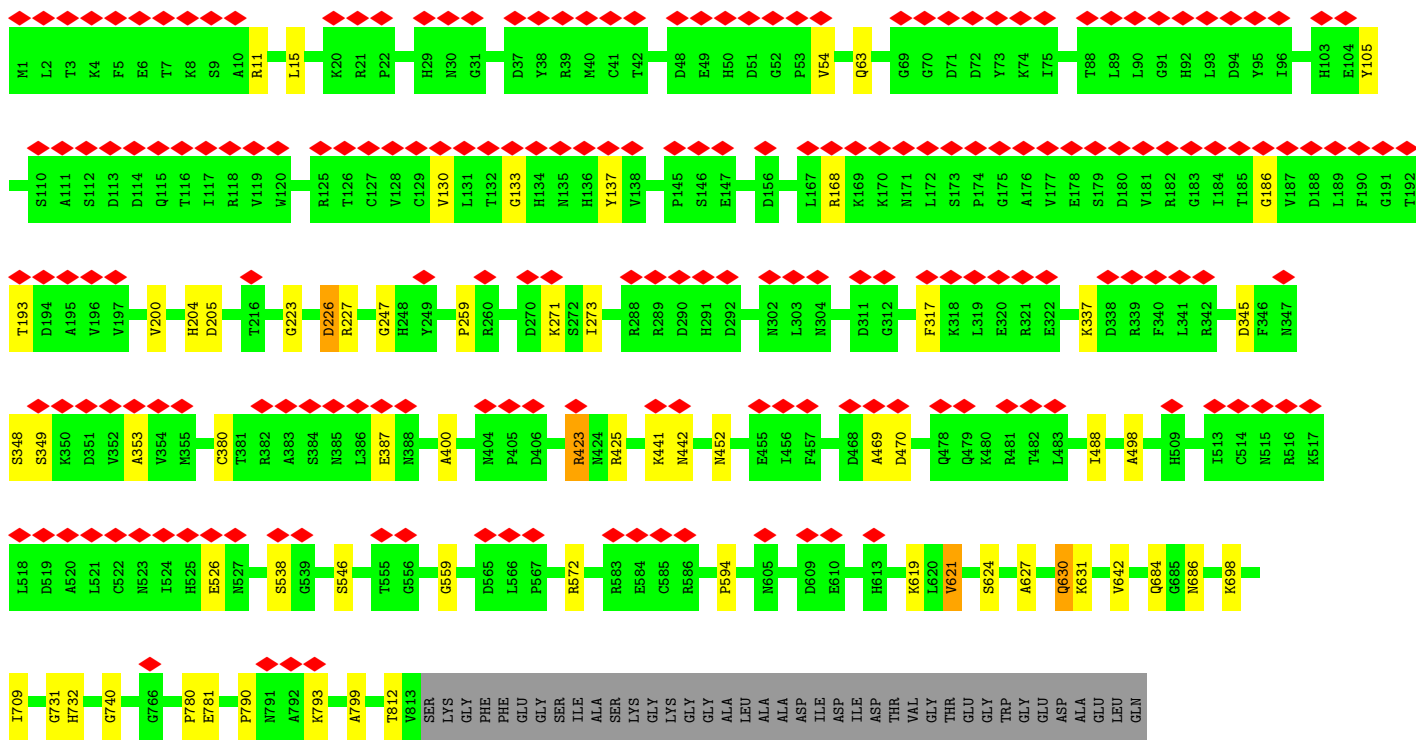

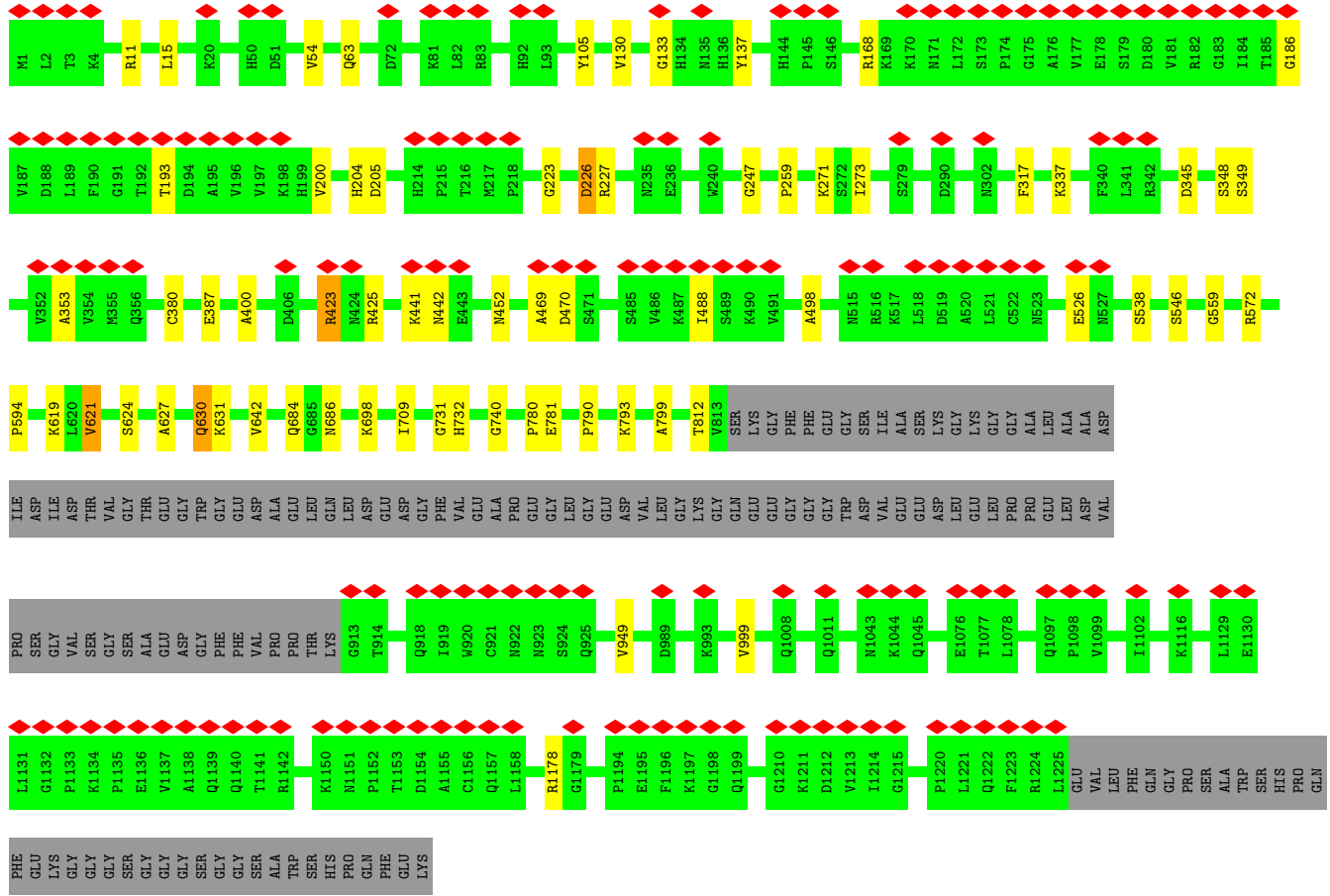

● Molecule 3: COATOMER SUBUNIT BETA

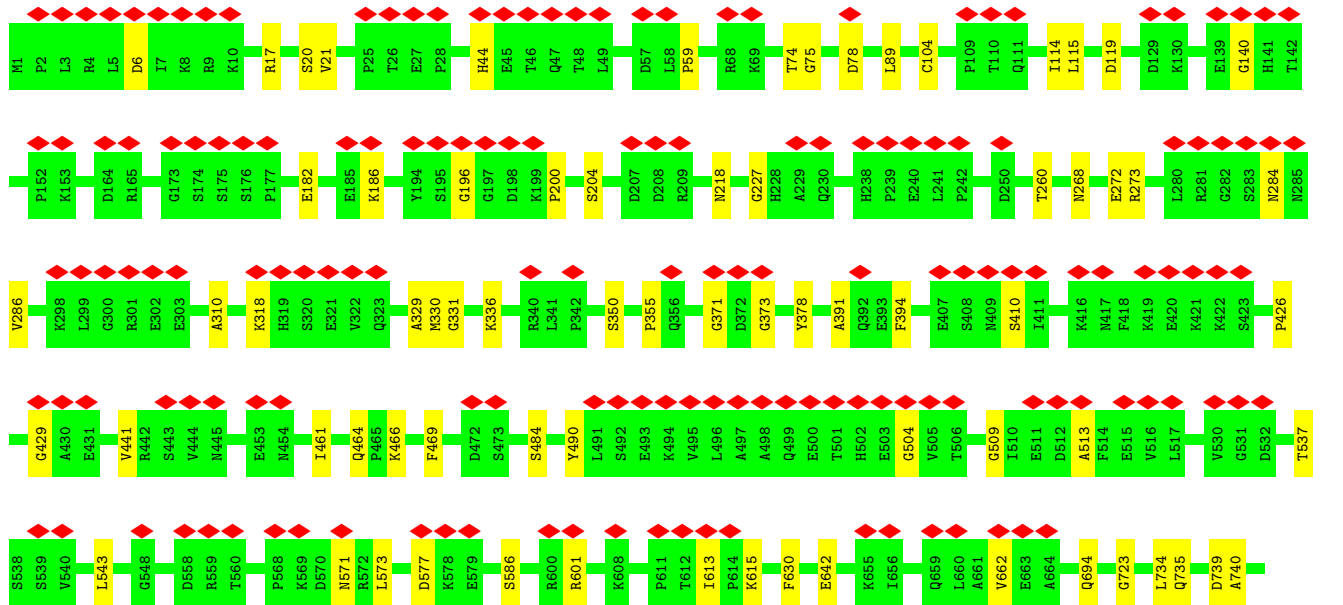
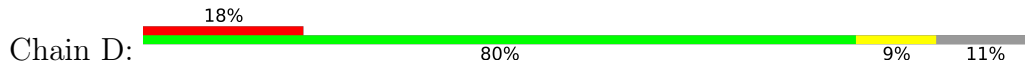

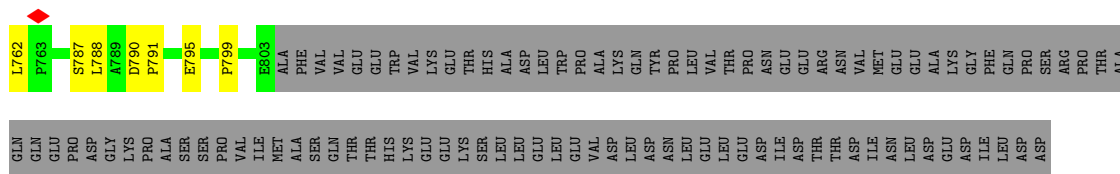

● Molecule 3: COATOMER SUBUNIT BETA

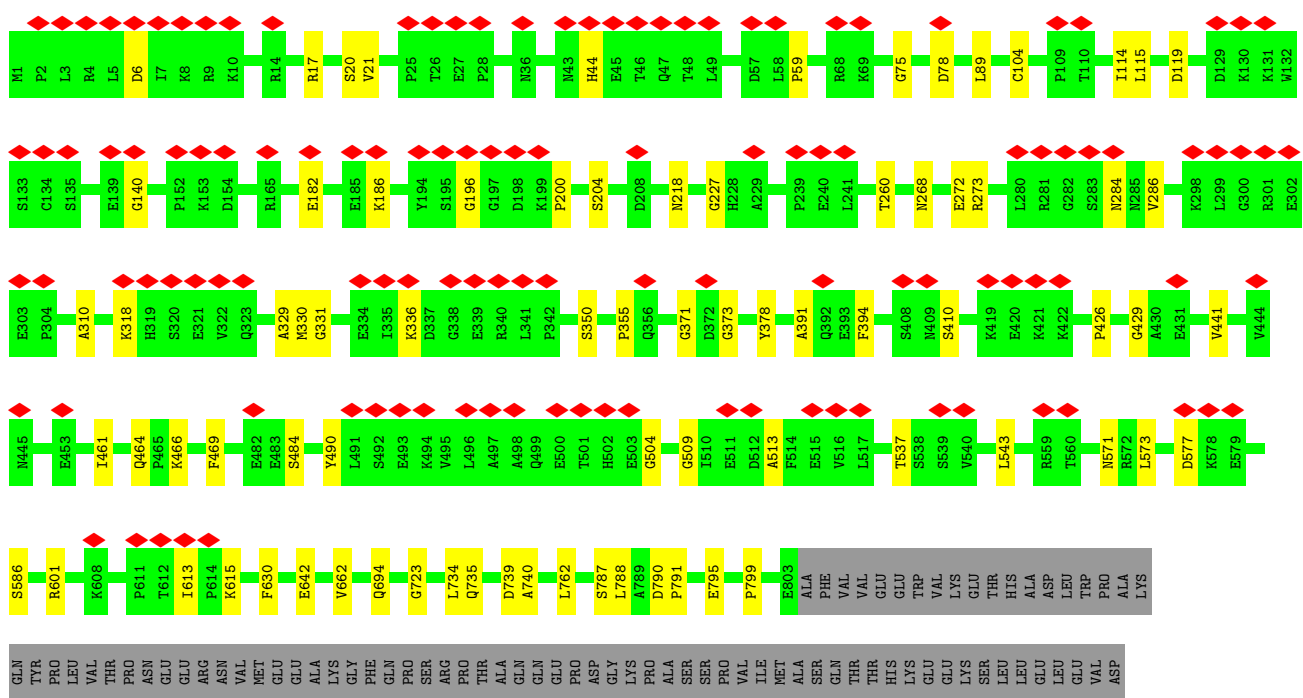
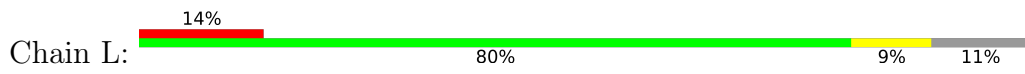

● Molecule 3: COATOMER SUBUNIT BETA

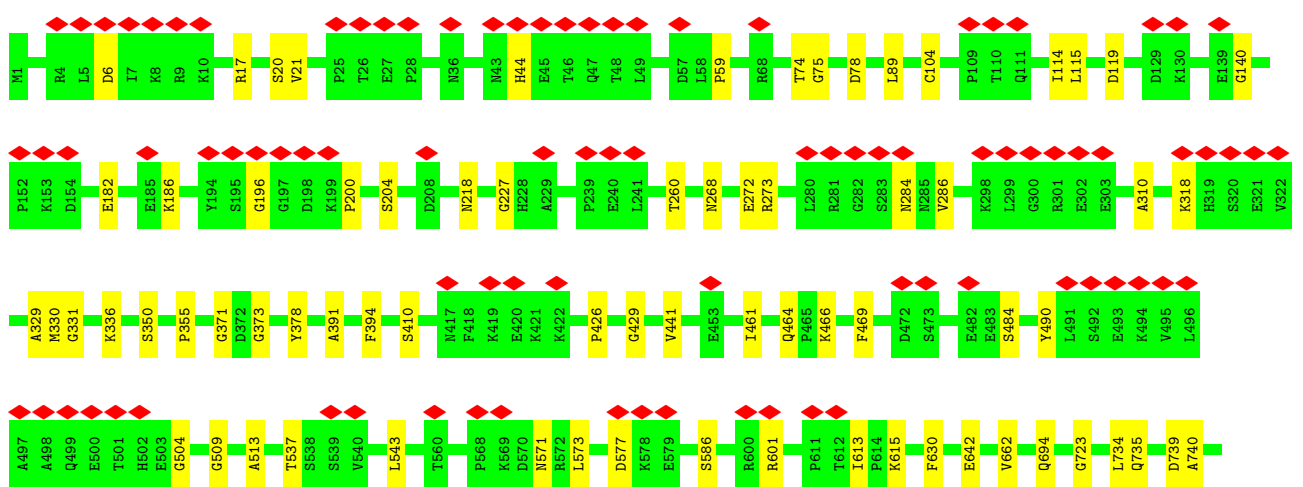
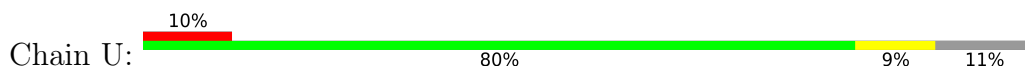

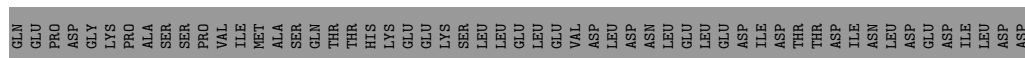
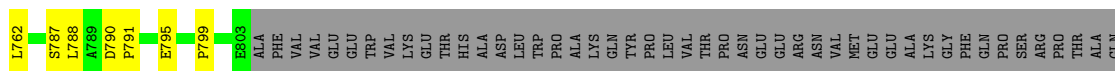

• Molecule 4: COATOMER SUBUNIT GAMMA-1

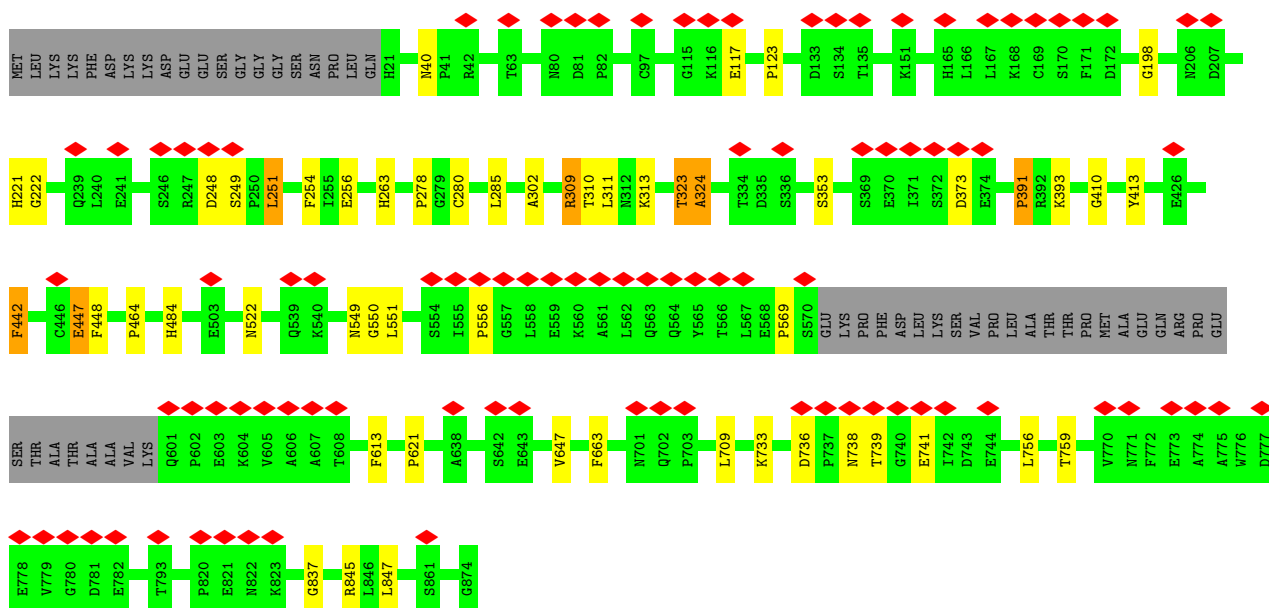
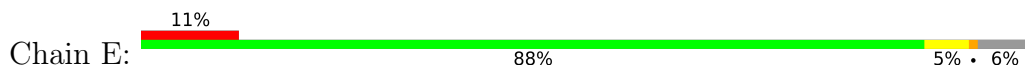

• Molecule 4: COATOMER SUBUNIT GAMMA-1

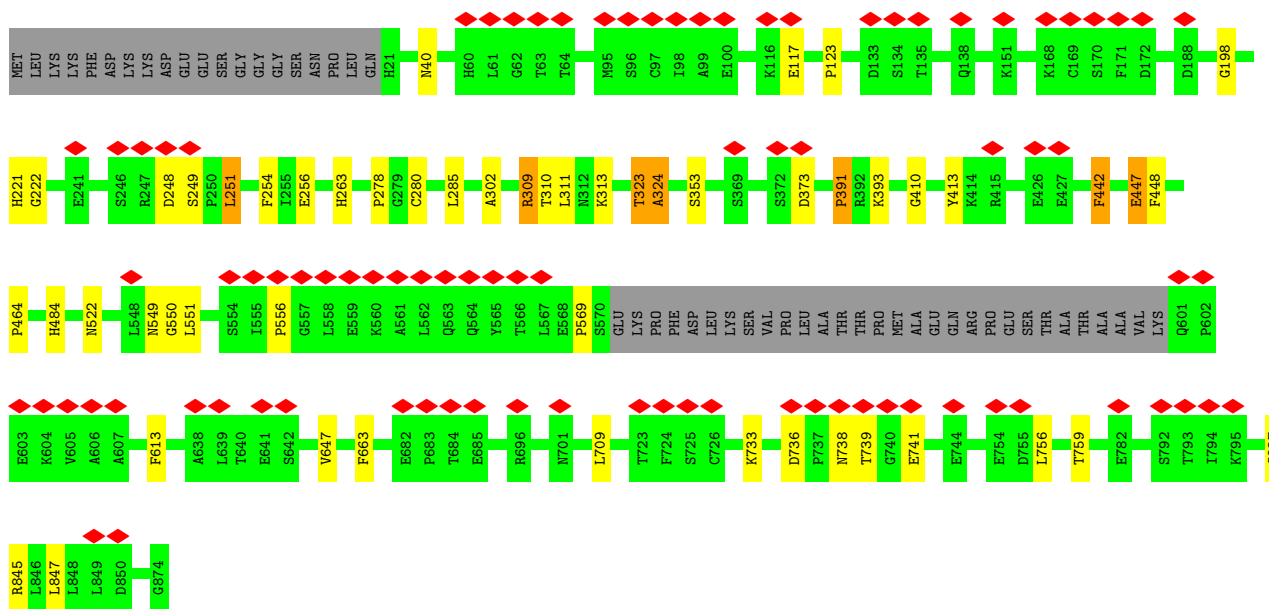
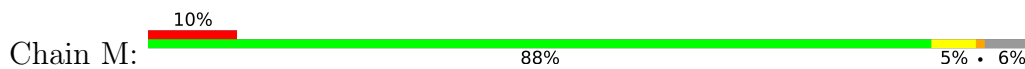

• Molecule 4: COATOMER SUBUNIT GAMMA-1

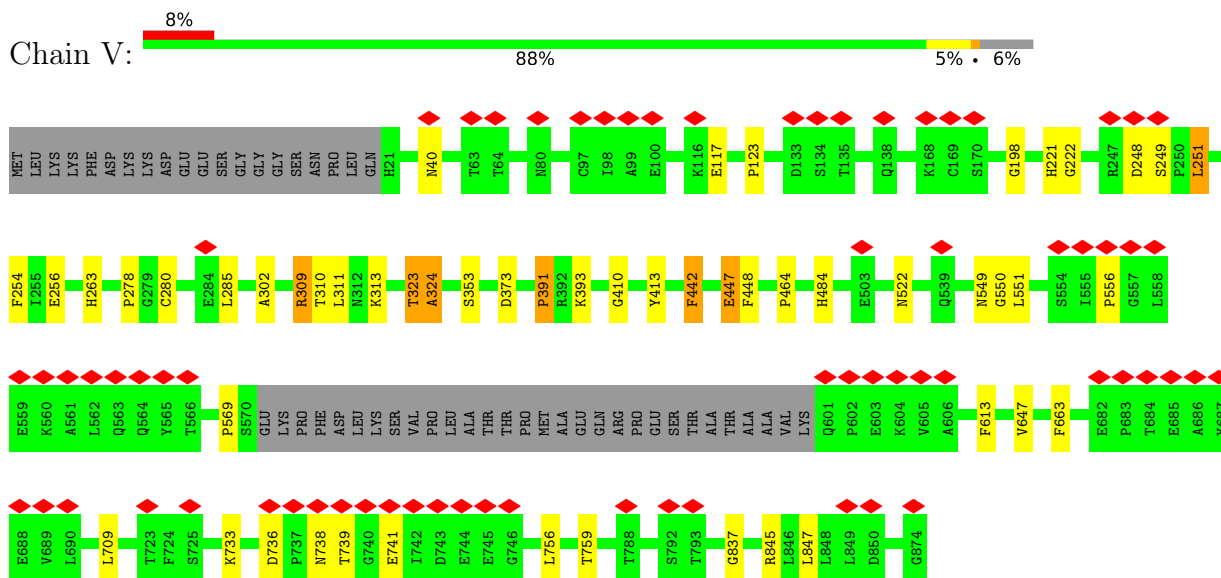

• Molecule 5: COATOMER SUBUNIT ZETA-1

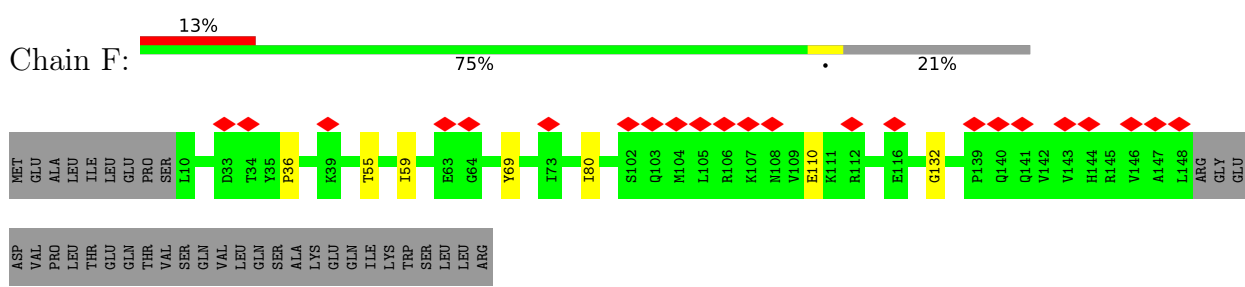

• Molecule 5: COATOMER SUBUNIT ZETA-1

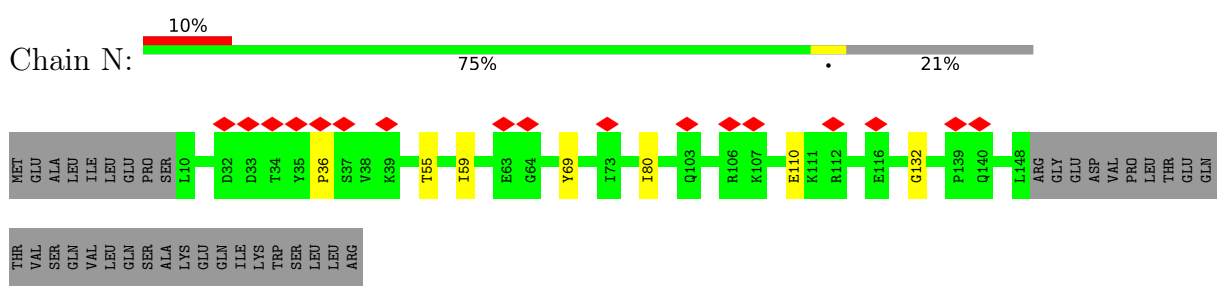

• Molecule 5: COATOMER SUBUNIT ZETA-1

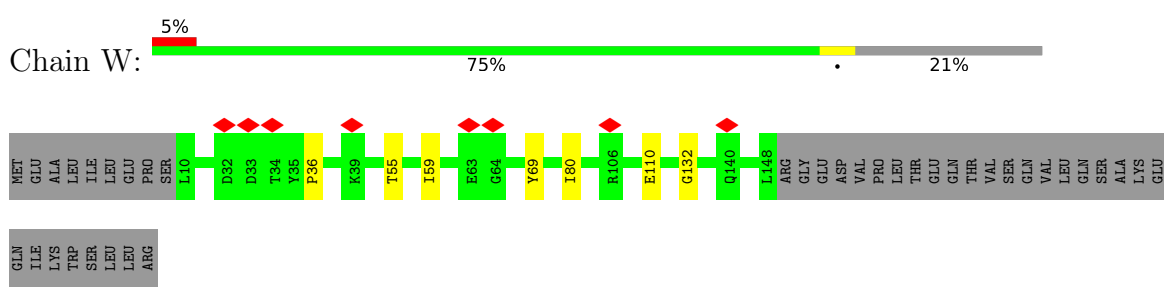

• Molecule 6: COATOMER SUBUNIT BETA'

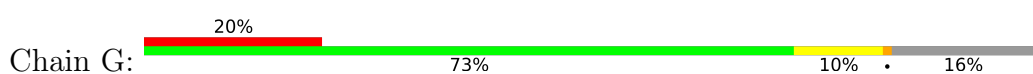

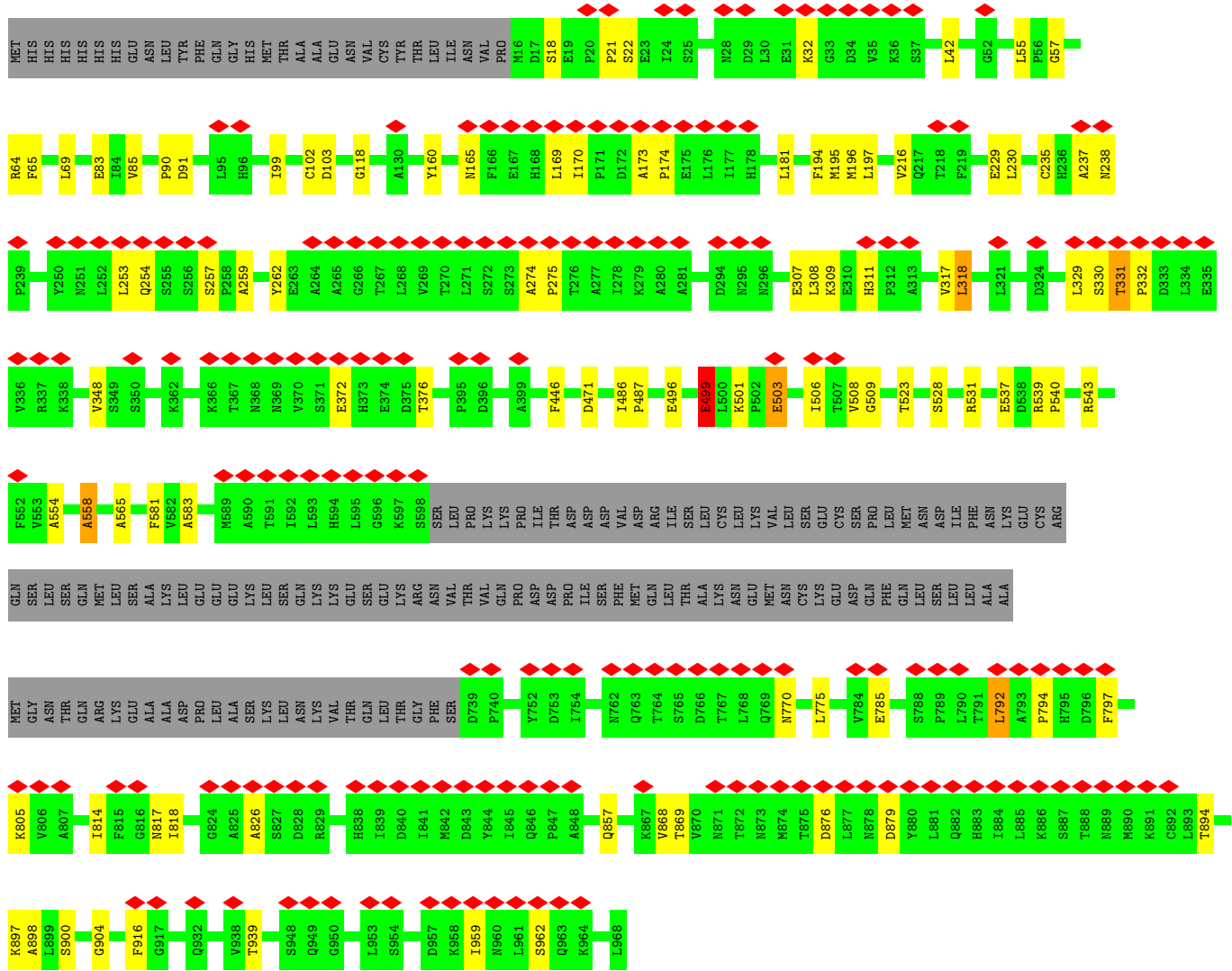

● Molecule 6: COATOMER SUBUNIT BETA'

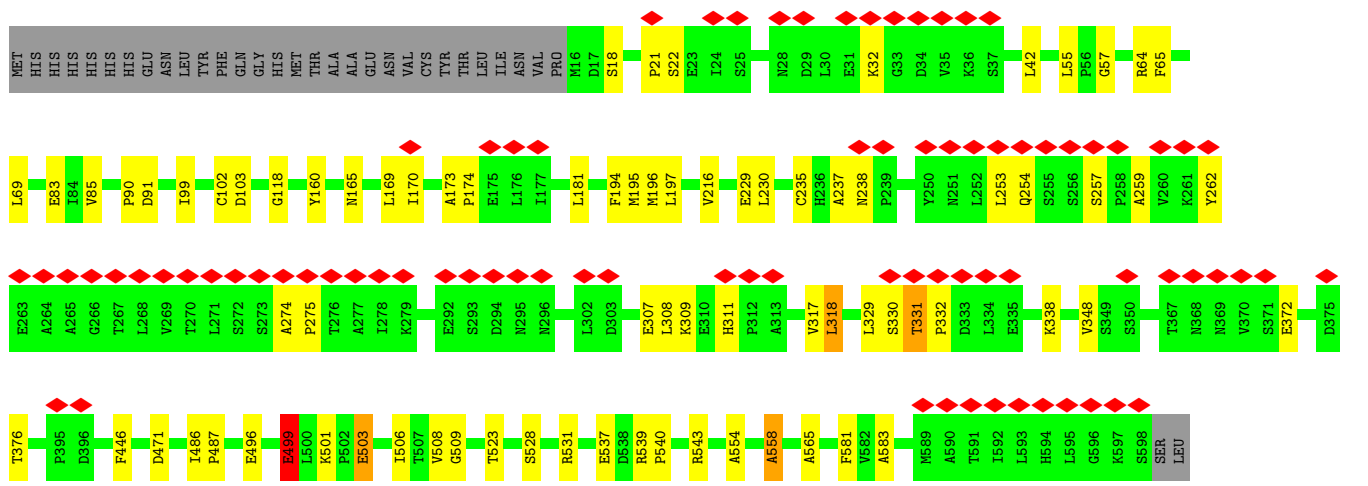
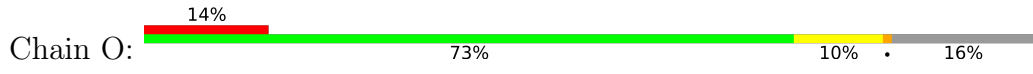

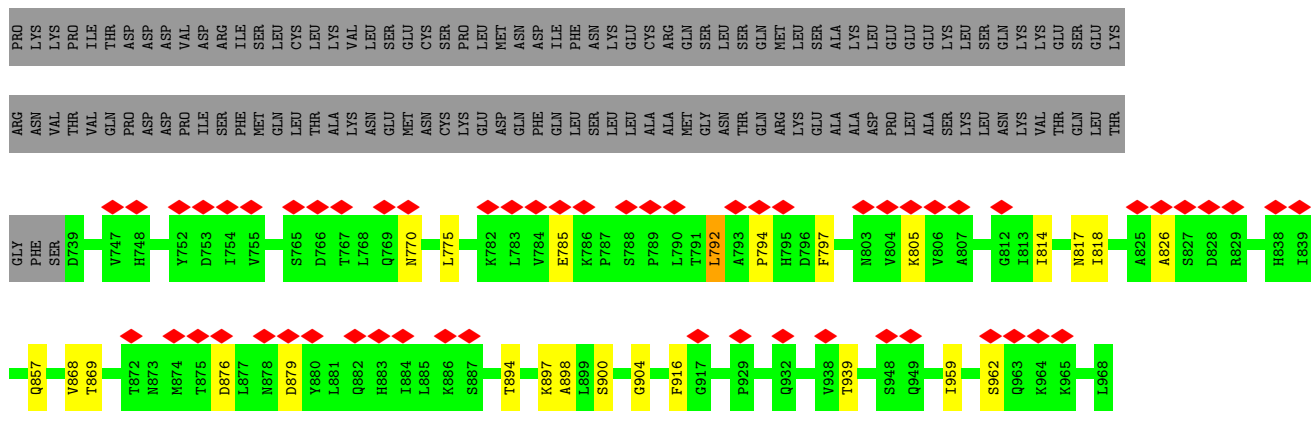

• Molecule 6: COATOMER SUBUNIT BETA'

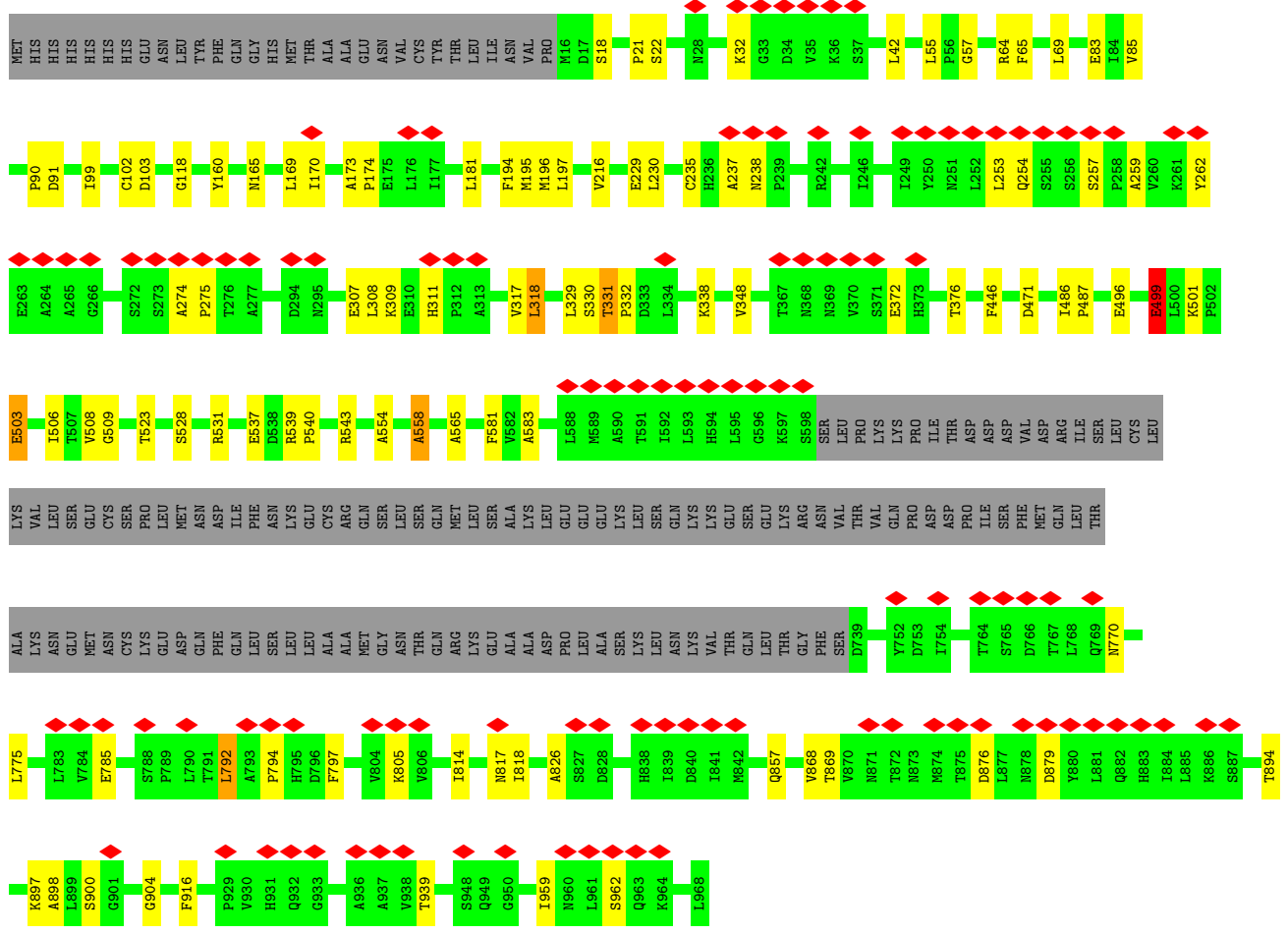
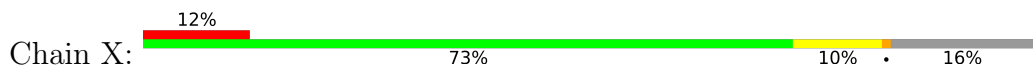

• Molecule 7: COATOMER SUBUNIT DELTA

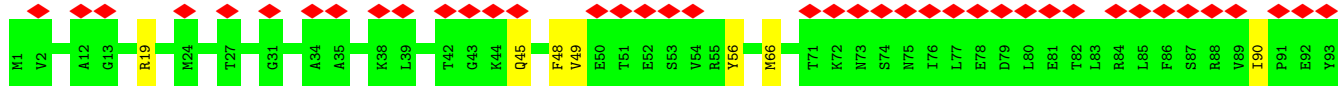

4 Experimental information

Property	Value	Source
EM reconstruction method	TOMOGRAPHY	Depositor
Imposed symmetry	POINT, C1	Depositor
Number of tilted images used	3684	Depositor
Resolution determination method	Not provided	
CTF correction method	PHASE FLIPPING OF INDIVIDUAL TILTS	Depositor
Microscope	FEI TITAN KRIOS	Depositor
Voltage (kV)	200	Depositor
Electron dose ($e^-/\text{\AA}^2$)	45	Depositor
Minimum defocus (nm)	1500	Depositor
Maximum defocus (nm)	4000	Depositor
Magnification	42000	Depositor
Image detector	GATAN MULTISCAN	Depositor
Maximum voxel value	7.329	Depositor
Minimum voxel value	-6.473	Depositor
Average voxel value	0.032	Depositor
Voxel value standard deviation	0.925	Depositor
Recommended contour level	1.7	Depositor
Tomogram size (\AA)	403.80002, 403.80002, 403.80002	wwPDB
Tomogram dimensions	200, 200, 200	wwPDB
Tomogram angles ($^\circ$)	90.0, 90.0, 90.0	wwPDB
Grid spacing (\AA)	2.019, 2.019, 2.019	Depositor

5 Model quality i

5.1 Standard geometry i

The Z score for a bond length (or angle) is the number of standard deviations the observed value is removed from the expected value. A bond length (or angle) with $|Z| > 5$ is considered an outlier worth inspection. RMSZ is the root-mean-square of all Z scores of the bond lengths (or angles).

Mol	Chain	Bond lengths		Bond angles	
		RMSZ	# Z >5	RMSZ	# Z >5
1	A	0.43	0/635	0.69	0/792
1	B	0.43	0/635	0.69	0/792
1	I	0.43	0/635	0.69	0/792
1	J	0.43	0/635	0.69	0/792
1	R	0.43	0/635	0.69	0/792
1	S	0.43	0/635	0.69	0/792
2	C	1.55	8/3250 (0.2%)	1.71	14/4061 (0.3%)
2	K	1.40	8/4501 (0.2%)	1.50	13/5623 (0.2%)
2	T	1.40	8/4501 (0.2%)	1.50	14/5623 (0.2%)
3	D	1.60	17/3210 (0.5%)	1.72	24/4011 (0.6%)
3	L	1.60	16/3210 (0.5%)	1.72	24/4011 (0.6%)
3	U	1.60	17/3210 (0.5%)	1.72	24/4011 (0.6%)
4	E	1.52	4/3292 (0.1%)	1.63	20/4112 (0.5%)
4	M	1.52	4/3292 (0.1%)	1.63	19/4112 (0.5%)
4	V	1.52	4/3292 (0.1%)	1.63	19/4112 (0.5%)
5	F	1.55	1/554 (0.2%)	1.74	3/691 (0.4%)
5	N	1.55	1/554 (0.2%)	1.74	3/691 (0.4%)
5	W	1.55	1/554 (0.2%)	1.74	3/691 (0.4%)
6	G	1.50	7/3248 (0.2%)	1.71	23/4057 (0.6%)
6	O	1.50	7/3248 (0.2%)	1.71	24/4057 (0.6%)
6	X	1.50	7/3248 (0.2%)	1.71	24/4057 (0.6%)
7	H	1.46	0/538	1.76	7/671 (1.0%)
7	P	1.46	0/538	1.76	7/671 (1.0%)
7	Y	1.46	0/538	1.76	7/671 (1.0%)
8	Q	0.91	0/1168	0.63	0/1457
8	Z	0.91	0/1168	0.63	0/1457
All	All	1.43	110/50924 (0.2%)	1.57	272/63599 (0.4%)

Chiral center outliers are detected by calculating the chiral volume of a chiral center and verifying if the center is modelled as a planar moiety or with the opposite hand. A planarity outlier is detected by checking planarity of atoms in a peptide group, atoms in a mainchain group or atoms of a sidechain that are expected to be planar.

Mol	Chain	#Chirality outliers	#Planarity outliers
2	C	0	4
2	K	0	4
2	T	0	4
3	D	0	2
3	L	0	2
3	U	0	2
4	E	0	4
4	M	0	4
4	V	0	4
5	F	0	1
5	N	0	1
5	W	0	1
6	G	0	14
6	O	0	14
6	X	0	14
All	All	0	75

All (110) bond length outliers are listed below:

Mol	Chain	Res	Type	Atoms	Z	Observed(Å)	Ideal(Å)
2	C	621	VAL	C-N	6.92	1.45	1.33
2	T	621	VAL	C-N	6.92	1.45	1.33
2	K	621	VAL	C-N	6.91	1.45	1.33
3	L	330	MET	N-CA	-6.82	1.32	1.46
3	D	330	MET	N-CA	-6.80	1.32	1.46
3	U	330	MET	N-CA	-6.78	1.32	1.46
3	D	378	TYR	N-CA	-6.42	1.33	1.46
3	L	378	TYR	N-CA	-6.42	1.33	1.46
4	M	198	GLY	CA-C	-6.41	1.41	1.51
4	E	198	GLY	CA-C	-6.41	1.41	1.51
4	V	198	GLY	CA-C	-6.39	1.41	1.51
3	U	378	TYR	N-CA	-6.36	1.33	1.46
3	U	537	THR	N-CA	-6.33	1.33	1.46
3	D	537	THR	N-CA	-6.32	1.33	1.46
6	X	118	GLY	CA-C	-6.31	1.41	1.51
3	L	537	THR	N-CA	-6.30	1.33	1.46
6	O	118	GLY	CA-C	-6.28	1.41	1.51
3	U	723	GLY	CA-C	-6.28	1.41	1.51
3	L	723	GLY	CA-C	-6.27	1.41	1.51
3	D	723	GLY	CA-C	-6.26	1.41	1.51
3	L	799	PRO	C-N	6.24	1.44	1.33
6	G	118	GLY	CA-C	-6.22	1.41	1.51
3	U	799	PRO	C-N	6.21	1.44	1.33

Continued on next page...

Continued from previous page...

Mol	Chain	Res	Type	Atoms	Z	Observed(Å)	Ideal(Å)
3	D	799	PRO	C-N	6.18	1.44	1.33
3	D	464	GLN	N-CA	-6.13	1.34	1.46
3	U	464	GLN	N-CA	-6.13	1.34	1.46
3	L	464	GLN	N-CA	-6.13	1.34	1.46
4	M	123	PRO	N-CA	-5.97	1.37	1.47
4	V	123	PRO	N-CA	-5.96	1.37	1.47
4	E	123	PRO	N-CA	-5.94	1.37	1.47
3	L	186	LYS	C-N	5.93	1.43	1.33
2	C	631	LYS	N-CA	-5.93	1.34	1.46
3	U	186	LYS	C-N	5.92	1.43	1.33
2	K	631	LYS	N-CA	-5.91	1.34	1.46
3	D	186	LYS	C-N	5.89	1.43	1.33
2	T	631	LYS	N-CA	-5.89	1.34	1.46
3	L	331	GLY	CA-C	-5.87	1.42	1.51
3	U	331	GLY	CA-C	-5.84	1.42	1.51
3	D	331	GLY	CA-C	-5.84	1.42	1.51
4	V	837	GLY	N-CA	-5.77	1.37	1.46
2	K	204	HIS	N-CA	-5.77	1.34	1.46
2	C	204	HIS	N-CA	-5.75	1.34	1.46
3	D	227	GLY	CA-C	-5.75	1.42	1.51
2	T	204	HIS	N-CA	-5.73	1.34	1.46
3	D	373	GLY	N-CA	-5.72	1.37	1.46
3	U	227	GLY	CA-C	-5.71	1.42	1.51
4	E	837	GLY	N-CA	-5.71	1.37	1.46
3	L	227	GLY	CA-C	-5.71	1.42	1.51
3	L	373	GLY	N-CA	-5.70	1.37	1.46
3	U	373	GLY	N-CA	-5.70	1.37	1.46
4	M	837	GLY	N-CA	-5.67	1.37	1.46
6	G	509	GLY	CA-C	-5.65	1.42	1.51
6	O	509	GLY	CA-C	-5.59	1.43	1.51
6	X	509	GLY	CA-C	-5.57	1.43	1.51
6	G	539	ARG	C-N	5.46	1.44	1.34
2	C	259	PRO	CA-C	-5.45	1.42	1.52
6	X	539	ARG	C-N	5.44	1.44	1.34
2	K	259	PRO	CA-C	-5.42	1.42	1.52
6	O	539	ARG	C-N	5.42	1.44	1.34
2	T	259	PRO	CA-C	-5.42	1.42	1.52
2	K	186	GLY	N-CA	-5.41	1.38	1.46
2	T	186	GLY	N-CA	-5.40	1.38	1.46
2	C	186	GLY	N-CA	-5.37	1.38	1.46
5	N	132	GLY	N-CA	-5.33	1.38	1.46
5	W	132	GLY	N-CA	-5.32	1.38	1.46

Continued on next page...

Continued from previous page...

Mol	Chain	Res	Type	Atoms	Z	Observed(Å)	Ideal(Å)
4	V	613	PHE	N-CA	-5.31	1.35	1.46
4	E	613	PHE	N-CA	-5.31	1.35	1.46
5	F	132	GLY	N-CA	-5.31	1.38	1.46
4	M	613	PHE	N-CA	-5.29	1.35	1.46
6	G	57	GLY	N-CA	5.29	1.53	1.46
2	C	740	GLY	CA-C	-5.28	1.43	1.51
6	X	57	GLY	N-CA	5.27	1.53	1.46
6	O	57	GLY	N-CA	5.26	1.53	1.46
2	K	740	GLY	CA-C	-5.26	1.43	1.51
2	T	740	GLY	CA-C	-5.24	1.43	1.51
3	L	466	LYS	N-CA	-5.24	1.35	1.46
6	X	160	TYR	N-CA	-5.22	1.35	1.46
3	U	466	LYS	N-CA	-5.21	1.35	1.46
3	D	466	LYS	N-CA	-5.21	1.35	1.46
6	O	160	TYR	N-CA	-5.21	1.35	1.46
6	G	160	TYR	N-CA	-5.20	1.35	1.46
2	K	130	VAL	C-N	5.18	1.46	1.34
2	K	353	ALA	N-CA	-5.17	1.36	1.46
3	D	504	GLY	N-CA	5.17	1.53	1.46
2	C	130	VAL	C-N	5.17	1.46	1.34
3	D	509	GLY	N-CA	-5.17	1.38	1.46
2	T	353	ALA	N-CA	-5.17	1.36	1.46
3	D	310	ALA	N-CA	-5.16	1.36	1.46
2	C	353	ALA	N-CA	-5.16	1.36	1.46
2	T	130	VAL	C-N	5.15	1.45	1.34
3	U	504	GLY	N-CA	5.14	1.53	1.46
3	U	586	SER	N-CA	-5.14	1.36	1.46
3	L	509	GLY	N-CA	-5.13	1.38	1.46
3	L	586	SER	N-CA	-5.13	1.36	1.46
3	L	504	GLY	N-CA	5.12	1.53	1.46
3	U	509	GLY	N-CA	-5.12	1.38	1.46
3	L	310	ALA	N-CA	-5.11	1.36	1.46
3	U	310	ALA	N-CA	-5.11	1.36	1.46
3	L	371	GLY	CA-C	-5.10	1.43	1.51
3	D	371	GLY	CA-C	-5.09	1.43	1.51
6	X	857	GLN	N-CA	-5.08	1.36	1.46
3	U	371	GLY	CA-C	-5.08	1.43	1.51
6	G	857	GLN	N-CA	-5.07	1.36	1.46
3	D	586	SER	N-CA	-5.07	1.36	1.46
6	O	857	GLN	N-CA	-5.07	1.36	1.46
3	D	74	THR	C-O	-5.04	1.13	1.23
6	O	565	ALA	N-CA	-5.02	1.36	1.46

Continued on next page...

Continued from previous page...

Mol	Chain	Res	Type	Atoms	Z	Observed(Å)	Ideal(Å)
6	X	565	ALA	N-CA	-5.01	1.36	1.46
3	U	74	THR	C-O	-5.01	1.13	1.23
6	G	565	ALA	N-CA	-5.00	1.36	1.46

All (272) bond angle outliers are listed below:

Mol	Chain	Res	Type	Atoms	Z	Observed(°)	Ideal(°)
6	O	496	GLU	N-CA-C	7.83	132.15	111.00
6	G	496	GLU	N-CA-C	7.81	132.10	111.00
6	X	496	GLU	N-CA-C	7.81	132.09	111.00
4	E	302	ALA	C-N-CA	7.05	139.32	121.70
4	V	302	ALA	C-N-CA	7.04	139.31	121.70
4	M	302	ALA	C-N-CA	7.04	139.30	121.70
2	C	54	VAL	N-CA-C	-6.93	92.29	111.00
2	T	54	VAL	N-CA-C	-6.91	92.34	111.00
2	K	54	VAL	N-CA-C	-6.90	92.37	111.00
6	G	486	ILE	O-C-N	-6.82	108.14	121.10
6	X	486	ILE	O-C-N	-6.80	108.19	121.10
6	O	486	ILE	O-C-N	-6.78	108.22	121.10
6	G	869	THR	N-CA-C	-6.74	92.80	111.00
6	X	869	THR	N-CA-C	-6.73	92.82	111.00
4	M	756	LEU	N-CA-C	-6.72	92.86	111.00
4	E	756	LEU	N-CA-C	-6.72	92.86	111.00
6	O	869	THR	N-CA-C	-6.72	92.87	111.00
4	V	756	LEU	N-CA-C	-6.71	92.88	111.00
3	U	490	TYR	N-CA-C	-6.64	93.07	111.00
3	D	490	TYR	N-CA-C	-6.63	93.09	111.00
6	G	486	ILE	CA-C-N	6.62	135.64	117.10
3	L	490	TYR	N-CA-C	-6.62	93.12	111.00
6	X	486	ILE	CA-C-N	6.62	135.62	117.10
6	O	486	ILE	CA-C-N	6.58	135.52	117.10
3	L	286	VAL	N-CA-C	-6.53	93.38	111.00
3	D	286	VAL	N-CA-C	-6.51	93.41	111.00
3	U	286	VAL	N-CA-C	-6.50	93.44	111.00
7	Y	90	ILE	CA-C-N	6.44	135.14	117.10
3	L	461	ILE	N-CA-C	-6.43	93.64	111.00
6	G	792	LEU	N-CA-C	-6.42	93.66	111.00
6	X	792	LEU	N-CA-C	-6.42	93.66	111.00
4	E	254	PHE	N-CA-C	-6.42	93.68	111.00
7	P	90	ILE	CA-C-N	6.42	135.06	117.10
7	H	90	ILE	CA-C-N	6.41	135.05	117.10
3	U	461	ILE	N-CA-C	-6.41	93.69	111.00

Continued on next page...

Continued from previous page...

Mol	Chain	Res	Type	Atoms	Z	Observed(°)	Ideal(°)
4	V	254	PHE	N-CA-C	-6.41	93.69	111.00
3	D	461	ILE	N-CA-C	-6.41	93.70	111.00
6	O	792	LEU	N-CA-C	-6.41	93.70	111.00
4	M	254	PHE	N-CA-C	-6.39	93.75	111.00
3	D	642	GLU	O-C-N	6.33	132.82	122.70
4	V	324	ALA	N-CA-C	6.32	128.06	111.00
4	M	324	ALA	N-CA-C	6.31	128.05	111.00
3	L	642	GLU	O-C-N	6.31	132.79	122.70
5	F	69	TYR	O-C-N	6.30	132.78	122.70
4	E	324	ALA	N-CA-C	6.30	128.01	111.00
5	W	69	TYR	O-C-N	6.29	132.77	122.70
3	L	204	SER	N-CA-C	-6.27	94.08	111.00
3	U	642	GLU	O-C-N	6.27	132.73	122.70
5	N	69	TYR	O-C-N	6.26	132.72	122.70
3	U	204	SER	N-CA-C	-6.26	94.08	111.00
3	D	204	SER	N-CA-C	-6.25	94.12	111.00
2	K	400	ALA	N-CA-C	-6.25	94.12	111.00
2	T	400	ALA	N-CA-C	-6.25	94.13	111.00
7	H	66	MET	N-CA-C	-6.24	94.17	111.00
2	C	400	ALA	N-CA-C	-6.23	94.17	111.00
7	P	66	MET	N-CA-C	-6.23	94.19	111.00
3	D	78	ASP	C-N-CA	6.21	137.23	121.70
3	U	78	ASP	C-N-CA	6.21	137.22	121.70
7	Y	66	MET	N-CA-C	-6.20	94.25	111.00
3	U	573	LEU	N-CA-C	-6.19	94.28	111.00
3	D	196	GLY	CA-C-O	6.19	131.74	120.60
3	U	613	ILE	N-CA-C	-6.19	94.29	111.00
3	D	573	LEU	N-CA-C	-6.18	94.30	111.00
3	L	78	ASP	C-N-CA	6.18	137.15	121.70
3	L	573	LEU	N-CA-C	-6.18	94.32	111.00
3	D	613	ILE	N-CA-C	-6.17	94.33	111.00
3	L	196	GLY	CA-C-O	6.17	131.72	120.60
3	L	613	ILE	N-CA-C	-6.15	94.38	111.00
3	U	196	GLY	CA-C-O	6.15	131.68	120.60
3	L	469	PHE	N-CA-C	-6.12	94.48	111.00
3	D	469	PHE	N-CA-C	-6.11	94.49	111.00
3	U	469	PHE	N-CA-C	-6.11	94.51	111.00
7	P	56	TYR	N-CA-C	-6.00	94.79	111.00
7	H	56	TYR	N-CA-C	-6.00	94.80	111.00
7	Y	56	TYR	N-CA-C	-5.99	94.83	111.00
6	G	376	THR	N-CA-C	-5.92	95.02	111.00
6	X	376	THR	N-CA-C	-5.91	95.06	111.00

Continued on next page...

Continued from previous page...

Mol	Chain	Res	Type	Atoms	Z	Observed(°)	Ideal(°)
6	O	376	THR	N-CA-C	-5.89	95.10	111.00
4	V	738	ASN	N-CA-C	-5.89	95.10	111.00
4	E	738	ASN	N-CA-C	-5.89	95.10	111.00
4	M	738	ASN	N-CA-C	-5.88	95.13	111.00
2	T	223	GLY	N-CA-C	-5.87	98.42	113.10
2	C	223	GLY	N-CA-C	-5.87	98.43	113.10
2	K	223	GLY	N-CA-C	-5.87	98.44	113.10
4	E	709	LEU	N-CA-C	-5.83	95.26	111.00
4	V	709	LEU	N-CA-C	-5.83	95.26	111.00
4	M	709	LEU	N-CA-C	-5.82	95.30	111.00
5	F	80	ILE	N-CA-C	-5.70	95.61	111.00
2	C	732	HIS	C-N-CA	5.70	135.94	121.70
2	K	732	HIS	C-N-CA	5.69	135.94	121.70
2	T	732	HIS	C-N-CA	5.69	135.92	121.70
2	K	105	TYR	N-CA-C	-5.69	95.65	111.00
2	C	105	TYR	N-CA-C	-5.68	95.66	111.00
2	T	105	TYR	N-CA-C	-5.68	95.66	111.00
5	W	80	ILE	N-CA-C	-5.68	95.66	111.00
5	N	80	ILE	N-CA-C	-5.68	95.67	111.00
4	M	759	THR	N-CA-C	-5.67	95.68	111.00
4	E	759	THR	N-CA-C	-5.67	95.70	111.00
4	V	759	THR	N-CA-C	-5.67	95.70	111.00
4	E	550	GLY	C-N-CA	5.66	135.84	121.70
6	G	499	GLU	N-CA-C	5.65	126.26	111.00
4	V	550	GLY	C-N-CA	5.65	135.83	121.70
4	M	222	GLY	N-CA-C	-5.65	98.98	113.10
6	X	499	GLU	N-CA-C	5.65	126.25	111.00
4	M	550	GLY	C-N-CA	5.64	135.81	121.70
4	E	222	GLY	N-CA-C	-5.64	99.00	113.10
6	O	499	GLU	N-CA-C	5.64	126.22	111.00
4	V	222	GLY	N-CA-C	-5.64	99.01	113.10
3	D	75	GLY	N-CA-C	-5.63	99.02	113.10
3	U	75	GLY	N-CA-C	-5.63	99.03	113.10
3	L	75	GLY	N-CA-C	-5.62	99.05	113.10
3	D	182	GLU	N-CA-C	-5.62	95.83	111.00
3	L	182	GLU	N-CA-C	-5.62	95.84	111.00
3	U	182	GLU	N-CA-C	-5.61	95.85	111.00
2	K	15	LEU	N-CA-C	-5.61	95.86	111.00
6	X	818	ILE	N-CA-C	-5.61	95.87	111.00
2	T	15	LEU	N-CA-C	-5.60	95.88	111.00
6	O	818	ILE	N-CA-C	-5.59	95.91	111.00
2	C	15	LEU	N-CA-C	-5.59	95.92	111.00

Continued on next page...

Continued from previous page...

Mol	Chain	Res	Type	Atoms	Z	Observed(°)	Ideal(°)
6	G	818	ILE	N-CA-C	-5.58	95.92	111.00
4	E	391	PRO	N-CA-C	5.58	126.59	112.10
4	M	391	PRO	N-CA-C	5.58	126.59	112.10
4	V	391	PRO	N-CA-C	5.57	126.58	112.10
6	X	503	GLU	N-CA-C	-5.57	95.96	111.00
6	G	503	GLU	N-CA-C	-5.57	95.97	111.00
6	O	503	GLU	N-CA-C	-5.56	95.98	111.00
6	O	196	MET	N-CA-C	-5.55	96.01	111.00
6	G	196	MET	N-CA-C	-5.53	96.07	111.00
3	U	429	GLY	N-CA-C	-5.53	99.28	113.10
6	X	196	MET	N-CA-C	-5.53	96.08	111.00
6	X	170	ILE	CA-C-N	5.52	132.55	117.10
4	V	733	LYS	N-CA-C	-5.52	96.10	111.00
6	O	170	ILE	CA-C-N	5.51	132.53	117.10
3	L	429	GLY	N-CA-C	-5.51	99.33	113.10
3	D	429	GLY	N-CA-C	-5.51	99.33	113.10
6	G	170	ILE	CA-C-N	5.51	132.52	117.10
6	X	195	MET	N-CA-C	-5.50	96.14	111.00
4	E	733	LYS	N-CA-C	-5.50	96.15	111.00
6	G	195	MET	N-CA-C	-5.50	96.15	111.00
4	M	733	LYS	N-CA-C	-5.50	96.16	111.00
2	K	630	GLN	N-CA-C	-5.48	96.19	111.00
6	O	195	MET	N-CA-C	-5.48	96.20	111.00
4	E	847	LEU	N-CA-C	-5.47	96.22	111.00
2	C	630	GLN	N-CA-C	-5.46	96.24	111.00
5	N	110	GLU	N-CA-C	-5.46	96.25	111.00
5	F	110	GLU	N-CA-C	-5.46	96.26	111.00
2	T	630	GLN	N-CA-C	-5.46	96.27	111.00
4	M	847	LEU	N-CA-C	-5.45	96.28	111.00
4	V	847	LEU	N-CA-C	-5.45	96.28	111.00
5	W	110	GLU	N-CA-C	-5.44	96.30	111.00
3	U	115	LEU	N-CA-C	-5.44	96.31	111.00
3	D	115	LEU	N-CA-C	-5.43	96.34	111.00
3	L	115	LEU	N-CA-C	-5.42	96.35	111.00
4	M	736	ASP	CA-C-O	-5.42	108.72	120.10
6	O	558	ALA	N-CA-C	-5.42	96.38	111.00
6	X	558	ALA	N-CA-C	-5.42	96.38	111.00
2	K	273	ILE	N-CA-C	-5.41	96.40	111.00
6	G	558	ALA	N-CA-C	-5.41	96.40	111.00
4	V	736	ASP	CA-C-O	-5.40	108.75	120.10
4	V	845	ARG	N-CA-C	-5.40	96.41	111.00
2	C	273	ILE	N-CA-C	-5.40	96.42	111.00

Continued on next page...

Continued from previous page...

Mol	Chain	Res	Type	Atoms	Z	Observed(°)	Ideal(°)
4	E	736	ASP	CA-C-O	-5.40	108.76	120.10
4	E	845	ARG	N-CA-C	-5.40	96.42	111.00
3	D	642	GLU	CA-C-O	-5.39	108.77	120.10
2	T	273	ILE	N-CA-C	-5.39	96.45	111.00
4	M	845	ARG	N-CA-C	-5.39	96.45	111.00
3	L	642	GLU	CA-C-O	-5.39	108.79	120.10
2	T	226	ASP	N-CA-C	-5.39	96.46	111.00
2	C	226	ASP	N-CA-C	-5.38	96.49	111.00
3	U	642	GLU	CA-C-O	-5.37	108.82	120.10
4	M	285	LEU	O-C-N	-5.36	114.12	122.70
2	K	226	ASP	N-CA-C	-5.36	96.52	111.00
4	V	285	LEU	O-C-N	-5.36	114.13	122.70
4	E	285	LEU	O-C-N	-5.35	114.14	122.70
7	Y	90	ILE	CA-C-O	-5.34	108.88	120.10
6	X	318	LEU	N-CA-C	5.33	125.41	111.00
4	E	647	VAL	N-CA-C	-5.33	96.61	111.00
6	G	318	LEU	N-CA-C	5.33	125.39	111.00
7	H	90	ILE	CA-C-O	-5.33	108.91	120.10
6	O	318	LEU	N-CA-C	5.33	125.38	111.00
4	V	647	VAL	N-CA-C	-5.32	96.64	111.00
7	P	90	ILE	CA-C-O	-5.32	108.93	120.10
4	M	647	VAL	N-CA-C	-5.31	96.66	111.00
3	D	441	VAL	N-CA-C	-5.31	96.67	111.00
3	L	441	VAL	N-CA-C	-5.30	96.68	111.00
7	H	49	VAL	N-CA-C	-5.30	96.69	111.00
7	Y	49	VAL	N-CA-C	-5.30	96.70	111.00
3	U	441	VAL	N-CA-C	-5.29	96.70	111.00
7	P	49	VAL	N-CA-C	-5.28	96.74	111.00
6	G	64	ARG	N-CA-C	5.22	125.10	111.00
3	D	394	PHE	N-CA-C	-5.21	96.92	111.00
6	O	64	ARG	N-CA-C	5.21	125.08	111.00
6	X	64	ARG	N-CA-C	5.21	125.08	111.00
3	U	394	PHE	N-CA-C	-5.21	96.93	111.00
3	L	394	PHE	N-CA-C	-5.21	96.94	111.00
2	K	423	ARG	C-N-CA	5.19	134.68	121.70
2	T	423	ARG	C-N-CA	5.19	134.68	121.70
7	H	19	ARG	C-N-CA	5.18	134.66	121.70
7	P	19	ARG	C-N-CA	5.18	134.65	121.70
7	Y	19	ARG	C-N-CA	5.18	134.65	121.70
2	C	423	ARG	C-N-CA	5.18	134.64	121.70
7	P	48	PHE	N-CA-C	-5.17	97.03	111.00
7	H	48	PHE	N-CA-C	-5.17	97.05	111.00

Continued on next page...

Continued from previous page...

Mol	Chain	Res	Type	Atoms	Z	Observed(°)	Ideal(°)
2	K	200	VAL	O-C-N	5.17	130.97	122.70
3	L	268	ASN	N-CA-C	-5.17	97.05	111.00
7	Y	48	PHE	N-CA-C	-5.17	97.06	111.00
4	M	663	PHE	N-CA-C	-5.16	97.06	111.00
3	U	268	ASN	N-CA-C	-5.16	97.06	111.00
3	D	268	ASN	N-CA-C	-5.16	97.08	111.00
3	L	21	VAL	N-CA-C	-5.16	97.08	111.00
4	V	663	PHE	N-CA-C	-5.15	97.10	111.00
4	E	663	PHE	N-CA-C	-5.15	97.11	111.00
6	G	775	LEU	N-CA-C	-5.14	97.11	111.00
3	U	21	VAL	N-CA-C	-5.14	97.11	111.00
3	D	21	VAL	N-CA-C	-5.13	97.13	111.00
2	T	200	VAL	O-C-N	5.13	130.91	122.70
6	X	775	LEU	N-CA-C	-5.13	97.14	111.00
6	G	868	VAL	N-CA-C	-5.13	97.15	111.00
2	C	200	VAL	O-C-N	5.13	130.90	122.70
6	G	229	GLU	C-N-CA	5.13	134.52	121.70
6	O	775	LEU	N-CA-C	-5.12	97.16	111.00
6	O	169	LEU	N-CA-C	-5.12	97.17	111.00
6	X	169	LEU	N-CA-C	-5.12	97.19	111.00
6	G	169	LEU	N-CA-C	-5.11	97.20	111.00
6	O	229	GLU	C-N-CA	5.11	134.48	121.70
6	X	229	GLU	C-N-CA	5.11	134.48	121.70
6	X	868	VAL	N-CA-C	-5.11	97.20	111.00
3	U	104	CYS	C-N-CA	5.10	134.46	121.70
6	O	868	VAL	N-CA-C	-5.10	97.22	111.00
3	D	104	CYS	C-N-CA	5.09	134.44	121.70
3	D	114	ILE	N-CA-C	-5.09	97.26	111.00
2	T	168	ARG	N-CA-C	-5.09	97.27	111.00
4	M	447	GLU	C-N-CA	5.08	134.40	121.70
3	U	543	LEU	O-C-N	-5.08	114.57	122.70
2	C	168	ARG	N-CA-C	-5.08	97.29	111.00
2	K	168	ARG	N-CA-C	-5.08	97.29	111.00
3	L	114	ILE	N-CA-C	-5.07	97.30	111.00
3	L	104	CYS	C-N-CA	5.07	134.38	121.70
4	E	447	GLU	C-N-CA	5.07	134.37	121.70
3	D	543	LEU	O-C-N	-5.07	114.59	122.70
3	U	114	ILE	N-CA-C	-5.07	97.32	111.00
4	V	447	GLU	C-N-CA	5.07	134.36	121.70
3	L	543	LEU	O-C-N	-5.06	114.60	122.70
6	G	805	LYS	N-CA-C	-5.05	97.36	111.00
2	K	684	GLN	C-N-CA	5.04	132.89	122.30

Continued on next page...

Continued from previous page...

Mol	Chain	Res	Type	Atoms	Z	Observed(°)	Ideal(°)
4	M	248	ASP	O-C-N	-5.04	114.63	122.70
6	O	165	ASN	C-N-CA	5.04	134.31	121.70
6	X	797	PHE	N-CA-C	-5.04	97.38	111.00
3	U	20	SER	C-N-CA	5.04	134.30	121.70
6	X	165	ASN	C-N-CA	5.04	134.30	121.70
6	G	165	ASN	C-N-CA	5.04	134.30	121.70
3	D	218	ASN	O-C-N	5.04	130.76	122.70
4	E	248	ASP	O-C-N	-5.04	114.64	122.70
3	L	20	SER	C-N-CA	5.04	134.29	121.70
6	G	797	PHE	N-CA-C	-5.04	97.41	111.00
6	X	805	LYS	N-CA-C	-5.04	97.40	111.00
6	O	797	PHE	N-CA-C	-5.03	97.41	111.00
4	V	248	ASP	O-C-N	-5.03	114.64	122.70
6	O	805	LYS	N-CA-C	-5.03	97.41	111.00
2	T	684	GLN	C-N-CA	5.03	132.86	122.30
6	O	42	LEU	O-C-N	-5.03	114.66	122.70
2	C	684	GLN	C-N-CA	5.02	132.84	122.30
3	D	20	SER	C-N-CA	5.02	134.25	121.70
6	X	338	LYS	O-C-N	5.02	130.73	122.70
6	O	338	LYS	O-C-N	5.02	130.73	122.70
3	L	218	ASN	O-C-N	5.01	130.72	122.70
6	X	42	LEU	O-C-N	-5.01	114.68	122.70
6	G	42	LEU	O-C-N	-5.01	114.68	122.70
2	T	709	ILE	C-N-CA	5.01	134.22	121.70
2	C	709	ILE	C-N-CA	5.01	134.22	121.70
4	E	621	PRO	O-C-N	5.00	130.70	122.70
3	U	218	ASN	O-C-N	5.00	130.70	122.70

There are no chirality outliers.

All (75) planarity outliers are listed below:

Mol	Chain	Res	Type	Group
2	C	317	PHE	Mainchain
2	C	380	CYS	Mainchain
2	C	559	GLY	Mainchain
2	C	63	GLN	Peptide
3	D	119	ASP	Mainchain
3	D	44	HIS	Mainchain
4	E	309	ARG	Peptide
4	E	323	THR	Peptide
4	E	442	PHE	Peptide
4	E	447	GLU	Peptide

Continued on next page...

Continued from previous page...

Mol	Chain	Res	Type	Group
5	F	59	ILE	Mainchain
6	G	235	CYS	Peptide
6	G	254	GLN	Peptide
6	G	274	ALA	Peptide
6	G	309	LYS	Peptide
6	G	311	HIS	Peptide
6	G	329	LEU	Peptide
6	G	331	THR	Peptide
6	G	348	VAL	Peptide
6	G	471	ASP	Peptide
6	G	499	GLU	Mainchain
6	G	581	PHE	Peptide
6	G	65	PHE	Mainchain
6	G	897	LYS	Peptide
6	G	91	ASP	Mainchain
2	K	317	PHE	Mainchain
2	K	380	CYS	Mainchain
2	K	559	GLY	Mainchain
2	K	63	GLN	Peptide
3	L	119	ASP	Mainchain
3	L	44	HIS	Mainchain
4	M	309	ARG	Peptide
4	M	323	THR	Peptide
4	M	442	PHE	Peptide
4	M	447	GLU	Peptide
5	N	59	ILE	Mainchain
6	O	235	CYS	Peptide
6	O	254	GLN	Peptide
6	O	274	ALA	Peptide
6	O	309	LYS	Peptide
6	O	311	HIS	Peptide
6	O	329	LEU	Peptide
6	O	331	THR	Peptide
6	O	348	VAL	Peptide
6	O	471	ASP	Peptide
6	O	499	GLU	Mainchain
6	O	581	PHE	Peptide
6	O	65	PHE	Mainchain
6	O	897	LYS	Peptide
6	O	91	ASP	Mainchain
2	T	317	PHE	Mainchain
2	T	380	CYS	Mainchain

Continued on next page...

Continued from previous page...

Mol	Chain	Res	Type	Group
2	T	559	GLY	Mainchain
2	T	63	GLN	Peptide
3	U	119	ASP	Mainchain
3	U	44	HIS	Mainchain
4	V	309	ARG	Peptide
4	V	323	THR	Peptide
4	V	442	PHE	Peptide
4	V	447	GLU	Peptide
5	W	59	ILE	Mainchain
6	X	235	CYS	Peptide
6	X	254	GLN	Peptide
6	X	274	ALA	Peptide
6	X	309	LYS	Peptide
6	X	311	HIS	Peptide
6	X	329	LEU	Peptide
6	X	331	THR	Peptide
6	X	348	VAL	Peptide
6	X	471	ASP	Peptide
6	X	499	GLU	Mainchain
6	X	581	PHE	Peptide
6	X	65	PHE	Mainchain
6	X	897	LYS	Peptide
6	X	91	ASP	Mainchain

5.2 Too-close contacts [i](#)

In the following table, the Non-H and H(model) columns list the number of non-hydrogen atoms and hydrogen atoms in the chain respectively. The H(added) column lists the number of hydrogen atoms added and optimized by MolProbity. The Clashes column lists the number of clashes within the asymmetric unit, whereas Symm-Clashes lists symmetry-related clashes.

Mol	Chain	Non-H	H(model)	H(added)	Clashes	Symm-Clashes
1	A	636	0	181	0	0
1	B	636	0	181	0	0
1	I	636	0	181	0	0
1	J	636	0	181	0	0
1	R	636	0	181	0	0
1	S	636	0	181	0	0
2	C	3251	0	869	0	0
2	K	4503	0	1194	0	0
2	T	4503	0	1194	0	0
3	D	3211	0	880	0	0

Continued on next page...

Continued from previous page...

Mol	Chain	Non-H	H(model)	H(added)	Clashes	Symm-Clashes
3	L	3211	0	880	0	0
3	U	3211	0	880	0	0
4	E	3294	0	852	1	0
4	M	3294	0	852	1	0
4	V	3294	0	852	1	0
5	F	555	0	148	0	0
5	N	555	0	148	0	0
5	W	555	0	148	0	0
6	G	3250	0	833	0	0
6	O	3250	0	833	0	0
6	X	3250	0	833	0	0
7	H	539	0	142	0	0
7	P	539	0	142	0	0
7	Y	539	0	142	0	0
8	Q	1169	0	303	0	0
8	Z	1169	0	303	0	0
All	All	50958	0	13514	3	0

The all-atom clashscore is defined as the number of clashes found per 1000 atoms (including hydrogen atoms). The all-atom clashscore for this structure is 0.

All (3) close contacts within the same asymmetric unit are listed below, sorted by their clash magnitude.

Atom-1	Atom-2	Interatomic distance (Å)	Clash overlap (Å)
4:M:249:SER:C	4:M:251:LEU:H	2.23	0.42
4:E:249:SER:C	4:E:251:LEU:H	2.23	0.42
4:V:249:SER:C	4:V:251:LEU:H	2.23	0.41

There are no symmetry-related clashes.

5.3 Torsion angles [i](#)

5.3.1 Protein backbone [i](#)

In the following table, the Percentiles column shows the percent Ramachandran outliers of the chain as a percentile score with respect to all PDB entries followed by that with respect to all EM entries.

The Analysed column shows the number of residues for which the backbone conformation was analysed, and the total number of residues.

Mol	Chain	Analysed	Favoured	Allowed	Outliers	Percentiles	
1	A	157/181 (87%)	153 (98%)	4 (2%)	0	100	100
1	B	157/181 (87%)	153 (98%)	4 (2%)	0	100	100
1	I	157/181 (87%)	153 (98%)	4 (2%)	0	100	100
1	J	157/181 (87%)	153 (98%)	4 (2%)	0	100	100
1	R	157/181 (87%)	153 (98%)	4 (2%)	0	100	100
1	S	157/181 (87%)	153 (98%)	4 (2%)	0	100	100
2	C	811/1262 (64%)	671 (83%)	97 (12%)	43 (5%)	2	19
2	K	1122/1262 (89%)	972 (87%)	104 (9%)	46 (4%)	3	23
2	T	1122/1262 (89%)	972 (87%)	104 (9%)	46 (4%)	3	23
3	D	801/905 (88%)	700 (87%)	64 (8%)	37 (5%)	2	21
3	L	801/905 (88%)	700 (87%)	64 (8%)	37 (5%)	2	21
3	U	801/905 (88%)	700 (87%)	64 (8%)	37 (5%)	2	21
4	E	820/874 (94%)	749 (91%)	40 (5%)	31 (4%)	3	24
4	M	820/874 (94%)	749 (91%)	40 (5%)	31 (4%)	3	24
4	V	820/874 (94%)	749 (91%)	40 (5%)	31 (4%)	3	24
5	F	137/177 (77%)	128 (93%)	7 (5%)	2 (2%)	10	46
5	N	137/177 (77%)	128 (93%)	7 (5%)	2 (2%)	10	46
5	W	137/177 (77%)	128 (93%)	7 (5%)	2 (2%)	10	46
6	G	809/968 (84%)	658 (81%)	84 (10%)	67 (8%)	1	12
6	O	809/968 (84%)	658 (81%)	84 (10%)	67 (8%)	1	12
6	X	809/968 (84%)	658 (81%)	84 (10%)	67 (8%)	1	12
7	H	133/511 (26%)	116 (87%)	16 (12%)	1 (1%)	19	60
7	P	133/511 (26%)	116 (87%)	16 (12%)	1 (1%)	19	60
7	Y	133/511 (26%)	116 (87%)	16 (12%)	1 (1%)	19	60
8	Q	290/308 (94%)	276 (95%)	9 (3%)	5 (2%)	9	42
8	Z	290/308 (94%)	276 (95%)	9 (3%)	5 (2%)	9	42
All	All	12677/15793 (80%)	11138 (88%)	980 (8%)	559 (4%)	4	22

All (559) Ramachandran outliers are listed below:

Mol	Chain	Res	Type
2	C	11	ARG
2	C	227	ARG
2	C	526	GLU

Continued on next page...

Continued from previous page...

Mol	Chain	Res	Type
2	C	572	ARG
2	C	686	ASN
3	D	6	ASP
3	D	284	ASN
3	D	329	ALA
3	D	336	LYS
3	D	350	SER
3	D	484	SER
3	D	513	ALA
3	D	615	LYS
3	D	791	PRO
3	D	795	GLU
4	E	117	GLU
4	E	280	CYS
4	E	309	ARG
4	E	323	THR
4	E	324	ALA
4	E	391	PRO
4	E	393	LYS
4	E	413	TYR
4	E	448	PHE
4	E	549	ASN
5	F	36	PRO
6	G	55	LEU
6	G	69	LEU
6	G	85	VAL
6	G	90	PRO
6	G	173	ALA
6	G	181	LEU
6	G	197	LEU
6	G	237	ALA
6	G	253	LEU
6	G	275	PRO
6	G	331	THR
6	G	499	GLU
6	G	506	ILE
6	G	508	VAL
6	G	523	THR
6	G	543	ARG
6	G	770	ASN
6	G	785	GLU
6	G	792	LEU

Continued on next page...

Continued from previous page...

Mol	Chain	Res	Type
6	G	814	ILE
6	G	826	ALA
6	G	939	THR
6	G	959	ILE
2	K	11	ARG
2	K	227	ARG
2	K	526	GLU
2	K	572	ARG
2	K	686	ASN
2	K	949	VAL
2	K	999	VAL
3	L	6	ASP
3	L	284	ASN
3	L	329	ALA
3	L	336	LYS
3	L	350	SER
3	L	484	SER
3	L	513	ALA
3	L	615	LYS
3	L	791	PRO
3	L	795	GLU
4	M	117	GLU
4	M	280	CYS
4	M	309	ARG
4	M	323	THR
4	M	324	ALA
4	M	391	PRO
4	M	393	LYS
4	M	413	TYR
4	M	448	PHE
4	M	549	ASN
5	N	36	PRO
6	O	55	LEU
6	O	69	LEU
6	O	85	VAL
6	O	90	PRO
6	O	173	ALA
6	O	181	LEU
6	O	197	LEU
6	O	237	ALA
6	O	253	LEU
6	O	275	PRO

Continued on next page...

Continued from previous page...

Mol	Chain	Res	Type
6	O	331	THR
6	O	499	GLU
6	O	506	ILE
6	O	508	VAL
6	O	523	THR
6	O	543	ARG
6	O	770	ASN
6	O	785	GLU
6	O	792	LEU
6	O	814	ILE
6	O	826	ALA
6	O	939	THR
6	O	959	ILE
8	Q	111	SER
8	Q	231	ARG
2	T	11	ARG
2	T	227	ARG
2	T	526	GLU
2	T	572	ARG
2	T	686	ASN
2	T	949	VAL
2	T	999	VAL
3	U	6	ASP
3	U	284	ASN
3	U	329	ALA
3	U	336	LYS
3	U	350	SER
3	U	484	SER
3	U	513	ALA
3	U	615	LYS
3	U	791	PRO
3	U	795	GLU
4	V	117	GLU
4	V	280	CYS
4	V	309	ARG
4	V	323	THR
4	V	324	ALA
4	V	391	PRO
4	V	393	LYS
4	V	413	TYR
4	V	448	PHE
4	V	549	ASN

Continued on next page...

Continued from previous page...

Mol	Chain	Res	Type
5	W	36	PRO
6	X	55	LEU
6	X	69	LEU
6	X	85	VAL
6	X	90	PRO
6	X	173	ALA
6	X	181	LEU
6	X	197	LEU
6	X	237	ALA
6	X	253	LEU
6	X	275	PRO
6	X	331	THR
6	X	499	GLU
6	X	506	ILE
6	X	508	VAL
6	X	523	THR
6	X	543	ARG
6	X	770	ASN
6	X	785	GLU
6	X	792	LEU
6	X	814	ILE
6	X	826	ALA
6	X	939	THR
6	X	959	ILE
8	Z	111	SER
8	Z	231	ARG
2	C	137	TYR
2	C	226	ASP
2	C	425	ARG
2	C	441	LYS
2	C	498	ALA
2	C	538	SER
2	C	546	SER
2	C	621	VAL
2	C	630	GLN
2	C	642	VAL
3	D	17	ARG
3	D	59	PRO
3	D	273	ARG
3	D	410	SER
3	D	426	PRO
3	D	630	PHE

Continued on next page...

Continued from previous page...

Mol	Chain	Res	Type
3	D	739	ASP
4	E	263	HIS
4	E	310	THR
4	E	313	LYS
4	E	373	ASP
4	E	442	PHE
4	E	484	HIS
4	E	551	LEU
4	E	739	THR
4	E	741	GLU
6	G	83	GLU
6	G	103	ASP
6	G	174	PRO
6	G	307	GLU
6	G	554	ALA
6	G	558	ALA
6	G	879	ASP
2	K	137	TYR
2	K	226	ASP
2	K	425	ARG
2	K	441	LYS
2	K	498	ALA
2	K	538	SER
2	K	546	SER
2	K	621	VAL
2	K	630	GLN
2	K	642	VAL
2	K	1178	ARG
3	L	17	ARG
3	L	59	PRO
3	L	273	ARG
3	L	410	SER
3	L	426	PRO
3	L	630	PHE
3	L	739	ASP
4	M	263	HIS
4	M	310	THR
4	M	313	LYS
4	M	373	ASP
4	M	442	PHE
4	M	484	HIS
4	M	551	LEU

Continued on next page...

Continued from previous page...

Mol	Chain	Res	Type
4	M	739	THR
4	M	741	GLU
6	O	83	GLU
6	O	103	ASP
6	O	174	PRO
6	O	307	GLU
6	O	554	ALA
6	O	558	ALA
6	O	879	ASP
2	T	137	TYR
2	T	226	ASP
2	T	425	ARG
2	T	441	LYS
2	T	498	ALA
2	T	538	SER
2	T	546	SER
2	T	621	VAL
2	T	630	GLN
2	T	642	VAL
2	T	1178	ARG
3	U	17	ARG
3	U	59	PRO
3	U	273	ARG
3	U	410	SER
3	U	426	PRO
3	U	630	PHE
3	U	739	ASP
4	V	263	HIS
4	V	310	THR
4	V	313	LYS
4	V	373	ASP
4	V	442	PHE
4	V	484	HIS
4	V	551	LEU
4	V	739	THR
4	V	741	GLU
6	X	83	GLU
6	X	103	ASP
6	X	174	PRO
6	X	307	GLU
6	X	554	ALA
6	X	558	ALA

Continued on next page...

Continued from previous page...

Mol	Chain	Res	Type
6	X	879	ASP
2	C	205	ASP
2	C	337	LYS
2	C	345	ASP
2	C	348	SER
2	C	349	SER
2	C	387	GLU
2	C	469	ALA
2	C	594	PRO
2	C	619	LYS
2	C	624	SER
2	C	627	ALA
2	C	790	PRO
3	D	140	GLY
3	D	260	THR
3	D	272	GLU
3	D	571	ASN
3	D	601	ARG
3	D	662	VAL
3	D	694	GLN
3	D	735	GLN
4	E	256	GLU
4	E	353	SER
4	E	522	ASN
4	E	569	PRO
5	F	55	THR
6	G	18	SER
6	G	22	SER
6	G	194	PHE
6	G	257	SER
6	G	259	ALA
6	G	308	LEU
6	G	318	LEU
6	G	487	PRO
6	G	501	LYS
6	G	528	SER
6	G	817	ASN
6	G	904	GLY
7	H	45	GLN
2	K	205	ASP
2	K	337	LYS
2	K	345	ASP

Continued on next page...

Continued from previous page...

Mol	Chain	Res	Type
2	K	348	SER
2	K	349	SER
2	K	387	GLU
2	K	469	ALA
2	K	594	PRO
2	K	619	LYS
2	K	624	SER
2	K	627	ALA
2	K	790	PRO
3	L	140	GLY
3	L	260	THR
3	L	272	GLU
3	L	571	ASN
3	L	601	ARG
3	L	662	VAL
3	L	694	GLN
3	L	735	GLN
4	M	256	GLU
4	M	353	SER
4	M	522	ASN
4	M	569	PRO
5	N	55	THR
6	O	18	SER
6	O	22	SER
6	O	194	PHE
6	O	257	SER
6	O	259	ALA
6	O	308	LEU
6	O	318	LEU
6	O	487	PRO
6	O	501	LYS
6	O	528	SER
6	O	817	ASN
6	O	904	GLY
7	P	45	GLN
2	T	205	ASP
2	T	337	LYS
2	T	345	ASP
2	T	348	SER
2	T	349	SER
2	T	387	GLU
2	T	469	ALA

Continued on next page...

Continued from previous page...

Mol	Chain	Res	Type
2	T	594	PRO
2	T	619	LYS
2	T	624	SER
2	T	627	ALA
2	T	790	PRO
3	U	140	GLY
3	U	260	THR
3	U	272	GLU
3	U	571	ASN
3	U	601	ARG
3	U	662	VAL
3	U	694	GLN
3	U	735	GLN
4	V	256	GLU
4	V	353	SER
4	V	522	ASN
4	V	569	PRO
5	W	55	THR
6	X	18	SER
6	X	22	SER
6	X	194	PHE
6	X	257	SER
6	X	259	ALA
6	X	308	LEU
6	X	318	LEU
6	X	487	PRO
6	X	501	LYS
6	X	528	SER
6	X	817	ASN
6	X	904	GLY
7	Y	45	GLN
2	C	133	GLY
2	C	193	THR
2	C	271	LYS
2	C	423	ARG
2	C	452	ASN
2	C	731	GLY
3	D	89	LEU
3	D	318	LYS
3	D	577	ASP
3	D	734	LEU
3	D	740	ALA

Continued on next page...

Continued from previous page...

Mol	Chain	Res	Type
3	D	787	SER
3	D	788	LEU
4	E	40	ASN
4	E	251	LEU
4	E	464	PRO
6	G	332	PRO
6	G	372	GLU
6	G	446	PHE
6	G	537	GLU
6	G	583	ALA
6	G	876	ASP
6	G	916	PHE
2	K	133	GLY
2	K	193	THR
2	K	271	LYS
2	K	423	ARG
2	K	452	ASN
2	K	731	GLY
3	L	89	LEU
3	L	318	LYS
3	L	577	ASP
3	L	734	LEU
3	L	740	ALA
3	L	787	SER
3	L	788	LEU
4	M	40	ASN
4	M	251	LEU
4	M	464	PRO
6	O	332	PRO
6	O	446	PHE
6	O	537	GLU
6	O	583	ALA
6	O	876	ASP
6	O	916	PHE
8	Q	113	ASP
2	T	133	GLY
2	T	193	THR
2	T	271	LYS
2	T	423	ARG
2	T	452	ASN
2	T	731	GLY
3	U	89	LEU

Continued on next page...

Continued from previous page...

Mol	Chain	Res	Type
3	U	318	LYS
3	U	577	ASP
3	U	734	LEU
3	U	740	ALA
3	U	787	SER
3	U	788	LEU
4	V	40	ASN
4	V	251	LEU
4	V	464	PRO
6	X	332	PRO
6	X	446	PHE
6	X	537	GLU
6	X	583	ALA
6	X	876	ASP
6	X	916	PHE
8	Z	113	ASP
2	C	470	ASP
2	C	698	LYS
2	C	793	LYS
2	C	812	THR
4	E	221	HIS
4	E	311	LEU
4	E	410	GLY
6	G	32	LYS
6	G	99	ILE
6	G	262	TYR
6	G	330	SER
6	G	794	PRO
6	G	894	THR
6	G	898	ALA
6	G	900	SER
6	G	962	SER
2	K	470	ASP
2	K	698	LYS
2	K	793	LYS
2	K	812	THR
4	M	221	HIS
4	M	311	LEU
4	M	410	GLY
6	O	32	LYS
6	O	99	ILE
6	O	262	TYR

Continued on next page...

Continued from previous page...

Mol	Chain	Res	Type
6	O	330	SER
6	O	372	GLU
6	O	794	PRO
6	O	894	THR
6	O	898	ALA
6	O	900	SER
6	O	962	SER
2	T	470	ASP
2	T	698	LYS
2	T	793	LYS
2	T	812	THR
4	V	221	HIS
4	V	311	LEU
4	V	410	GLY
6	X	32	LYS
6	X	99	ILE
6	X	262	TYR
6	X	330	SER
6	X	372	GLU
6	X	794	PRO
6	X	894	THR
6	X	898	ALA
6	X	900	SER
6	X	962	SER
2	C	442	ASN
2	C	781	GLU
3	D	391	ALA
6	G	21	PRO
6	G	102	CYS
6	G	230	LEU
6	G	503	GLU
2	K	442	ASN
2	K	781	GLU
3	L	391	ALA
6	O	21	PRO
6	O	102	CYS
6	O	230	LEU
6	O	503	GLU
2	T	442	ASN
2	T	781	GLU
3	U	391	ALA
6	X	21	PRO

Continued on next page...

Continued from previous page...

Mol	Chain	Res	Type
6	X	102	CYS
6	X	230	LEU
6	X	503	GLU
3	D	790	ASP
6	G	216	VAL
6	G	238	ASN
3	L	790	ASP
6	O	216	VAL
6	O	238	ASN
3	U	790	ASP
6	X	216	VAL
6	X	238	ASN
2	C	780	PRO
2	C	799	ALA
3	D	355	PRO
4	E	278	PRO
6	G	540	PRO
2	K	780	PRO
2	K	799	ALA
3	L	355	PRO
6	O	540	PRO
8	Q	213	SER
2	T	780	PRO
2	T	799	ALA
3	U	355	PRO
6	X	540	PRO
8	Z	213	SER
3	D	762	LEU
6	G	531	ARG
3	L	762	LEU
4	M	278	PRO
6	O	531	ARG
3	U	762	LEU
4	V	278	PRO
6	X	531	ARG
3	D	200	PRO
4	E	556	PRO
6	G	317	VAL
4	M	556	PRO
6	O	317	VAL
4	V	556	PRO
6	X	317	VAL

Continued on next page...

Continued from previous page...

Mol	Chain	Res	Type
2	C	247	GLY
2	C	488	ILE
2	K	247	GLY
2	K	488	ILE
3	L	200	PRO
8	Q	45	SER
2	T	247	GLY
2	T	488	ILE
3	U	200	PRO
8	Z	45	SER

5.3.2 Protein sidechains [i](#)

There are no protein residues with a non-rotameric sidechain to report in this entry.

5.3.3 RNA [i](#)

There are no RNA molecules in this entry.

5.4 Non-standard residues in protein, DNA, RNA chains [i](#)

There are no non-standard protein/DNA/RNA residues in this entry.

5.5 Carbohydrates [i](#)

There are no monosaccharides in this entry.

5.6 Ligand geometry [i](#)

There are no ligands in this entry.

5.7 Other polymers [i](#)

There are no such residues in this entry.

5.8 Polymer linkage issues [i](#)

There are no chain breaks in this entry.

6 Tomogram visualisation [i](#)

This section contains visualisations of the EMDB entry EMD-2986. These allow visual inspection of the internal detail of the tomogram and identification of artifacts.

6.1 Orthogonal projections [i](#)

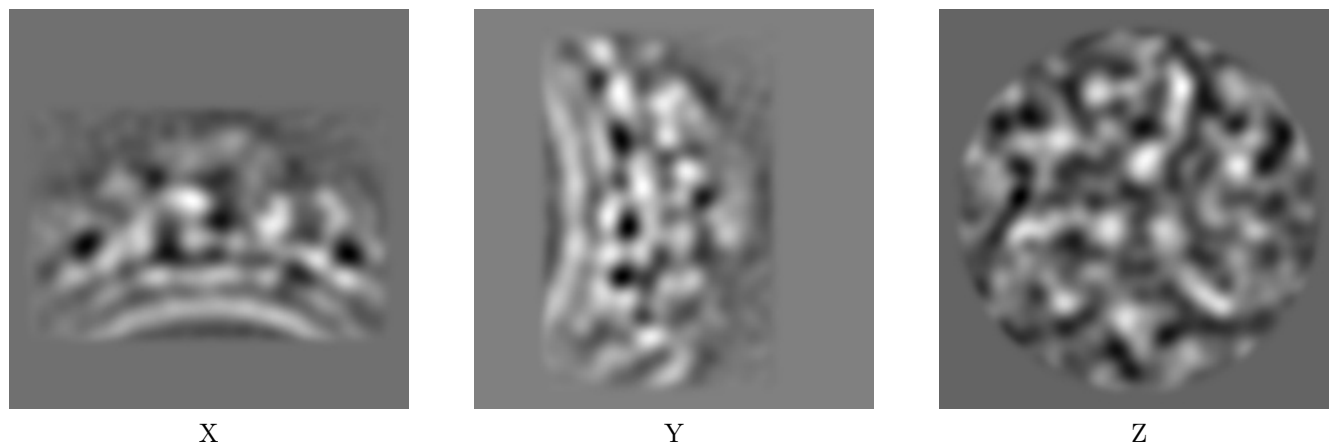

The images above show the tomogram projected in three orthogonal directions.

6.2 Central slices [i](#)

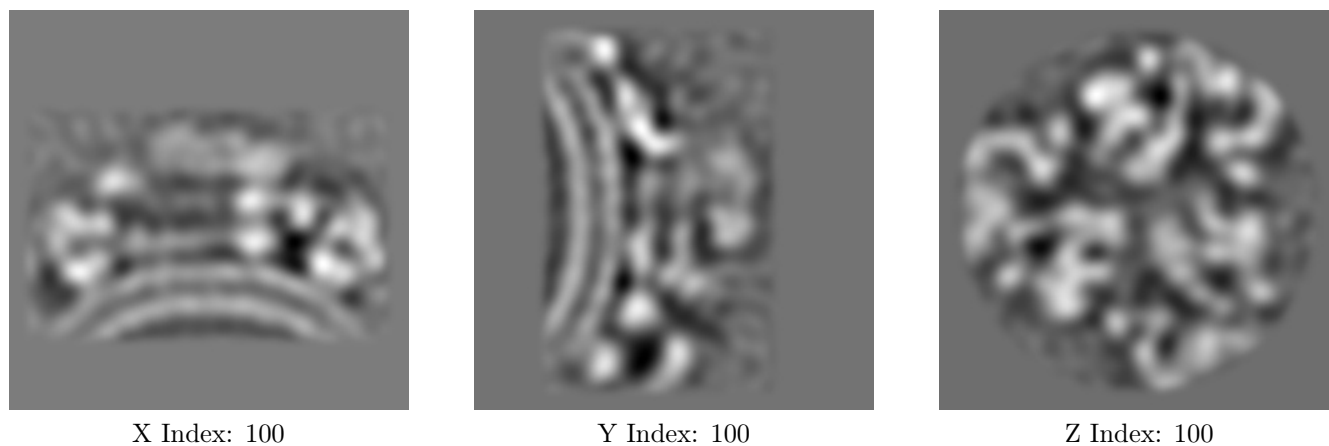

The images above show central slices of the tomogram in three orthogonal directions.

6.3 Largest variance slices [i](#)



X Index: 88



Y Index: 134

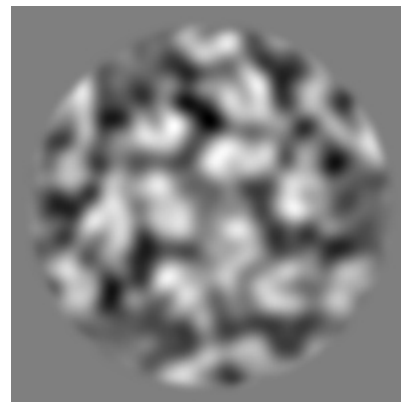

Z Index: 83

The images above show the largest variance slices of the tomogram in three orthogonal directions.

6.4 Mask visualisation [i](#)

This section was not generated. No masks/segmentation were deposited.

7 Tomogram analysis [i](#)

This section contains the results of statistical analysis of the tomogram.

7.1 Voxel-value distribution [i](#)

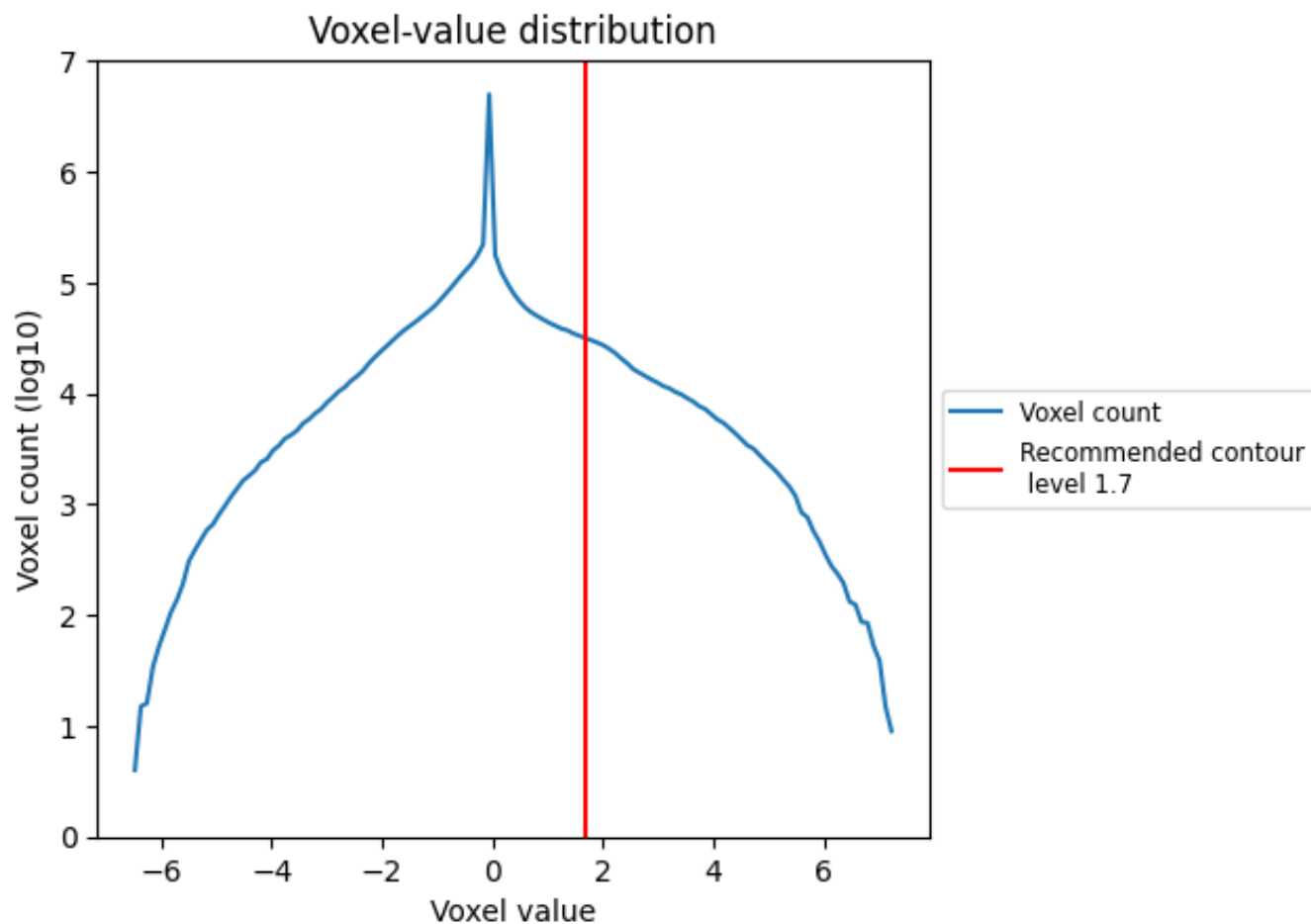

The voxel-value distribution is plotted in 128 intervals along the x-axis. The y-axis is logarithmic.

8 Map-model fit [i](#)

This section contains information regarding the fit between EMDB map EMD-2986 and PDB model 5A1V. Per-residue inclusion information can be found in section 3 on page 11.

8.1 Map-model overlay [i](#)

This section was not generated.

8.2 Q-score mapped to coordinate model [i](#)

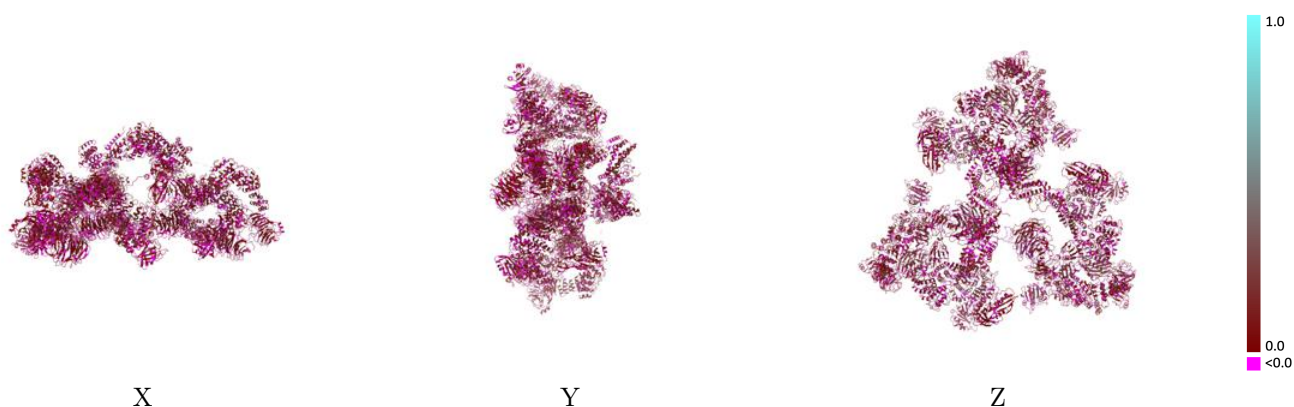

The images above show the model with each residue coloured according to its Q-score. This shows their resolvability in the map with higher Q-score values reflecting better resolvability. Please note: Q-score is calculating the resolvability of atoms, and thus high values are only expected at resolutions at which atoms can be resolved. Low Q-score values may therefore be expected for many entries.

8.3 Atom inclusion mapped to coordinate model [i](#)

This section was not generated.



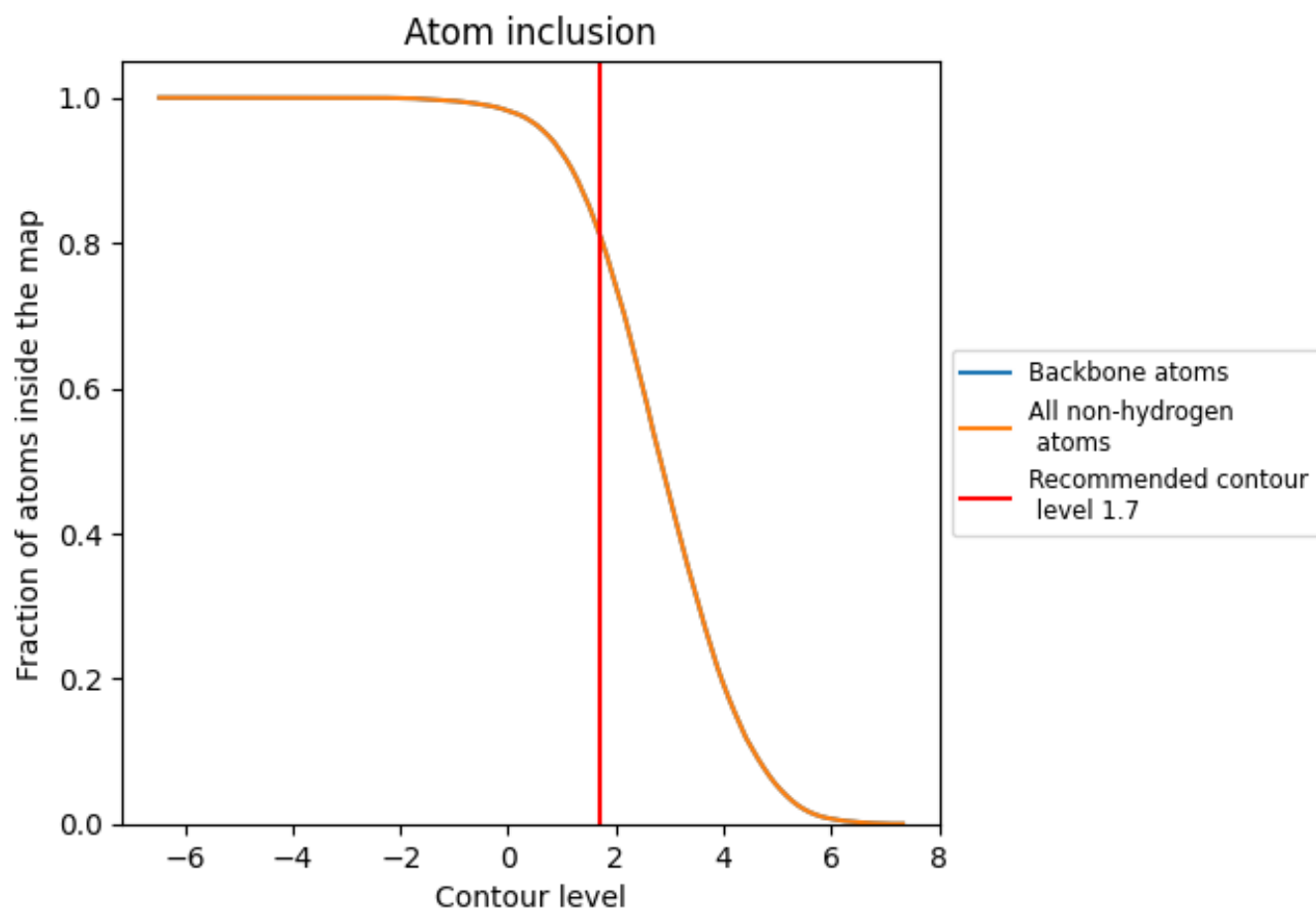



















































8.4 Atom inclusion [i](#)



At the recommended contour level, 81% of all backbone atoms, 81% of all non-hydrogen atoms, are inside the map.

8.5 Map-model fit summary

The table lists the average atom inclusion at the recommended contour level (1.7) and Q-score for the entire model and for each chain.

Chain	Atom inclusion	Q-score
All	 0.8118	 0.0670
A	 0.8066	 0.0600
B	 0.4717	 0.0520
C	 0.7376	 0.0600
D	 0.7730	 0.0660
E	 0.8631	 0.0720
F	 0.8090	 0.0620
G	 0.7372	 0.0640
H	 0.6104	 0.0410
I	 0.8003	 0.0640
J	 0.7201	 0.0490
K	 0.8397	 0.0710
L	 0.8256	 0.0710
M	 0.8764	 0.0760
N	 0.8559	 0.0630
O	 0.8074	 0.0710
P	 0.8349	 0.0450
Q	 0.6219	 0.0490
R	 0.8365	 0.0600
S	 0.7343	 0.0470
T	 0.8463	 0.0730
U	 0.8695	 0.0710
V	 0.8998	 0.0750
W	 0.9243	 0.0600
X	 0.8394	 0.0700
Y	 0.8831	 0.0610
Z	 0.6972	 0.0620

