



Full wwPDB X-ray Structure Validation Report ⓘ

Sep 17, 2023 – 06:57 PM EDT

PDB ID : 4XSX
Title : Crystal structure of CBR 703 bound to Escherichia coli RNA polymerase holoenzyme
Authors : Bae, B.; Darst, S.A.
Deposited on : 2015-01-22
Resolution : 3.71 Å(reported)

This is a Full wwPDB X-ray Structure Validation Report for a publicly released PDB entry.

We welcome your comments at validation@mail.wwpdb.org

A user guide is available at

<https://www.wwpdb.org/validation/2017/XrayValidationReportHelp>

with specific help available everywhere you see the ⓘ symbol.

The types of validation reports are described at

<http://www.wwpdb.org/validation/2017/FAQs#types>.

The following versions of software and data (see [references ⓘ](#)) were used in the production of this report:

MolProbity : 4.02b-467
Mogul : 1.8.5 (274361), CSD as541be (2020)
Xtriage (Phenix) : 1.13
EDS : 2.35.1
buster-report : 1.1.7 (2018)
Percentile statistics : 20191225.v01 (using entries in the PDB archive December 25th 2019)
Refmac : 5.8.0158
CCP4 : 7.0.044 (Gargrove)
Ideal geometry (proteins) : Engh & Huber (2001)
Ideal geometry (DNA, RNA) : Parkinson et al. (1996)
Validation Pipeline (wwPDB-VP) : 2.35.1

1 Overall quality at a glance i

The following experimental techniques were used to determine the structure:

X-RAY DIFFRACTION

The reported resolution of this entry is 3.71 Å.

Percentile scores (ranging between 0-100) for global validation metrics of the entry are shown in the following graphic. The table shows the number of entries on which the scores are based.

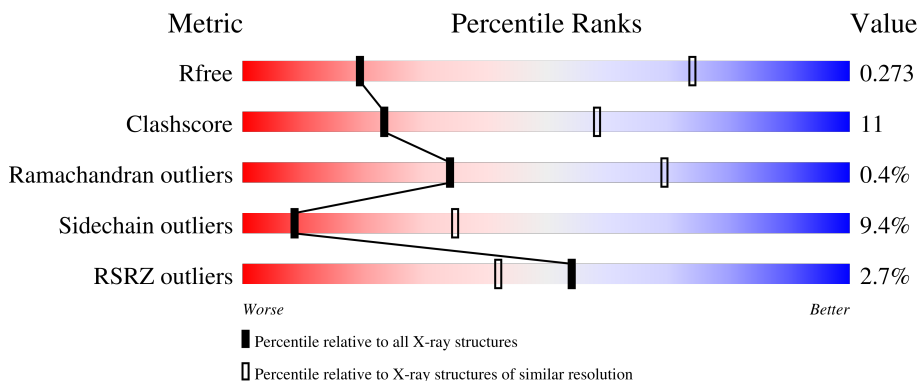

Metric	Whole archive (#Entries)	Similar resolution (#Entries, resolution range(Å))
R_{free}	130704	1049 (3.88-3.52)
Clashscore	141614	1027 (3.86-3.54)
Ramachandran outliers	138981	1069 (3.88-3.52)
Sidechain outliers	138945	1065 (3.88-3.52)
RSRZ outliers	127900	1578 (3.90-3.50)

The table below summarises the geometric issues observed across the polymeric chains and their fit to the electron density. The red, orange, yellow and green segments of the lower bar indicate the fraction of residues that contain outliers for ≥ 3 , 2, 1 and 0 types of geometric quality criteria respectively. A grey segment represents the fraction of residues that are not modelled. The numeric value for each fraction is indicated below the corresponding segment, with a dot representing fractions $\leq 5\%$. The upper red bar (where present) indicates the fraction of residues that have poor fit to the electron density. The numeric value is given above the bar.

Mol	Chain	Length	Quality of chain
1	A	239	
1	B	239	
1	G	239	
1	H	239	
2	C	1342	

Continued on next page...

Continued from previous page...

Mol	Chain	Length	Quality of chain
2	I	1342	
3	D	1407	
3	J	1407	
4	E	91	
4	K	91	
5	F	522	
5	L	522	

The following table lists non-polymeric compounds, carbohydrate monomers and non-standard residues in protein, DNA, RNA chains that are outliers for geometric or electron-density-fit criteria:

Mol	Type	Chain	Res	Chirality	Geometry	Clashes	Electron density
7	MG	J	1501	-	-	-	X
8	ZN	D	1503	-	-	-	X

2 Entry composition

There are 8 unique types of molecules in this entry. The entry contains 55722 atoms, of which 0 are hydrogens and 0 are deuteriums.

In the tables below, the ZeroOcc column contains the number of atoms modelled with zero occupancy, the AltConf column contains the number of residues with at least one atom in alternate conformation and the Trace column contains the number of residues modelled with at most 2 atoms.

- Molecule 1 is a protein called DNA-directed RNA polymerase subunit alpha.

Mol	Chain	Residues	Atoms					ZeroOcc	AltConf	Trace
			Total	C	N	O	S			
1	A	224	Total 1730	C 1076	N 308	O 340	S 6	0	0	0
1	B	220	Total 1687	C 1053	N 298	O 330	S 6	0	0	0
1	G	228	Total 1750	C 1088	N 312	O 344	S 6	0	0	0
1	H	217	Total 1667	C 1041	N 293	O 327	S 6	0	0	0

There are 20 discrepancies between the modelled and reference sequences:

Chain	Residue	Modelled	Actual	Comment	Reference
A	235	GLU	-	expression tag	UNP A7ZSI4
A	236	VAL	-	expression tag	UNP A7ZSI4
A	237	LEU	-	expression tag	UNP A7ZSI4
A	238	PHE	-	expression tag	UNP A7ZSI4
A	239	GLN	-	expression tag	UNP A7ZSI4
B	235	GLU	-	expression tag	UNP A7ZSI4
B	236	VAL	-	expression tag	UNP A7ZSI4
B	237	LEU	-	expression tag	UNP A7ZSI4
B	238	PHE	-	expression tag	UNP A7ZSI4
B	239	GLN	-	expression tag	UNP A7ZSI4
G	235	GLU	-	expression tag	UNP A7ZSI4
G	236	VAL	-	expression tag	UNP A7ZSI4
G	237	LEU	-	expression tag	UNP A7ZSI4
G	238	PHE	-	expression tag	UNP A7ZSI4
G	239	GLN	-	expression tag	UNP A7ZSI4
H	235	GLU	-	expression tag	UNP A7ZSI4
H	236	VAL	-	expression tag	UNP A7ZSI4
H	237	LEU	-	expression tag	UNP A7ZSI4
H	238	PHE	-	expression tag	UNP A7ZSI4
H	239	GLN	-	expression tag	UNP A7ZSI4

- Molecule 2 is a protein called DNA-directed RNA polymerase subunit beta.

Mol	Chain	Residues	Atoms					ZeroOcc	AltConf	Trace
			Total	C	N	O	S			
2	C	1340	Total	C	N	O	S	0	0	0
			10570	6631	1841	2055	43			
2	I	1340	Total	C	N	O	S	0	0	0
			10566	6629	1840	2054	43			

- Molecule 3 is a protein called DNA-directed RNA polymerase subunit beta'.

Mol	Chain	Residues	Atoms					ZeroOcc	AltConf	Trace
			Total	C	N	O	S			
3	D	1166	Total	C	N	O	S	0	0	0
			9107	5723	1634	1704	46			
3	J	1236	Total	C	N	O	S	0	0	0
			9638	6058	1726	1807	47			

- Molecule 4 is a protein called DNA-directed RNA polymerase subunit omega.

Mol	Chain	Residues	Atoms					ZeroOcc	AltConf	Trace
			Total	C	N	O	S			
4	E	89	Total	C	N	O	S	0	0	0
			691	421	129	140	1			
4	K	79	Total	C	N	O	S	0	0	0
			627	382	118	126	1			

- Molecule 5 is a protein called RNA polymerase sigma factor RpoD.

Mol	Chain	Residues	Atoms					ZeroOcc	AltConf	Trace
			Total	C	N	O	S			
5	F	470	Total	C	N	O	S	0	0	0
			3822	2394	680	725	23			
5	L	469	Total	C	N	O	S	0	0	0
			3821	2393	679	726	23			

- Molecule 6 is N'-hydroxy-N-phenyl-3-(trifluoromethyl)benzenecarboximidamide (three-letter code: 42S) (formula: C₁₄H₁₁F₃N₂O).

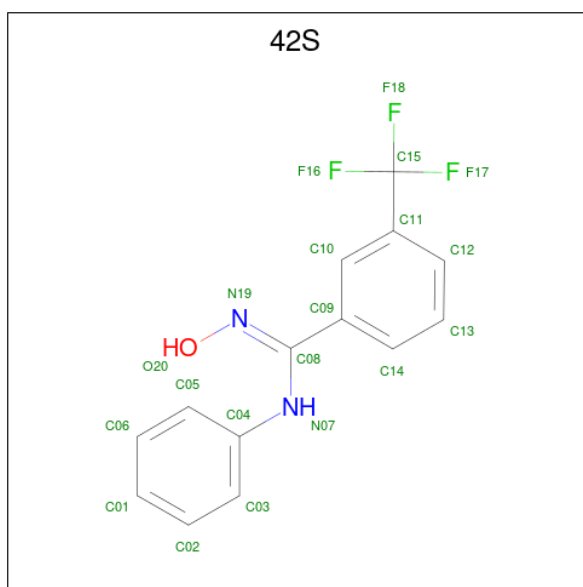

Mol	Chain	Residues	Atoms				ZeroOcc	AltConf	
6	C	1	Total	C	F	N	O	0	0
			20	14	3	2	1		
6	I	1	Total	C	F	N	O	0	0
			20	14	3	2	1		

- Molecule 7 is MAGNESIUM ION (three-letter code: MG) (formula: Mg).

Mol	Chain	Residues	Atoms		ZeroOcc	AltConf
7	D	1	Total	Mg	0	0
			1	1		
7	J	1	Total	Mg	0	0
			1	1		

- Molecule 8 is ZINC ION (three-letter code: ZN) (formula: Zn).

Mol	Chain	Residues	Atoms		ZeroOcc	AltConf
8	D	2	Total	Zn	0	0
			2	2		
8	J	2	Total	Zn	0	0
			2	2		

3 Residue-property plots

These plots are drawn for all protein, RNA, DNA and oligosaccharide chains in the entry. The first graphic for a chain summarises the proportions of the various outlier classes displayed in the second graphic. The second graphic shows the sequence view annotated by issues in geometry and electron density. Residues are color-coded according to the number of geometric quality criteria for which they contain at least one outlier: green = 0, yellow = 1, orange = 2 and red = 3 or more. A red dot above a residue indicates a poor fit to the electron density ($RSRZ > 2$). Stretches of 2 or more consecutive residues without any outlier are shown as a green connector. Residues present in the sample, but not in the model, are shown in grey.

- Molecule 1: DNA-directed RNA polymerase subunit alpha

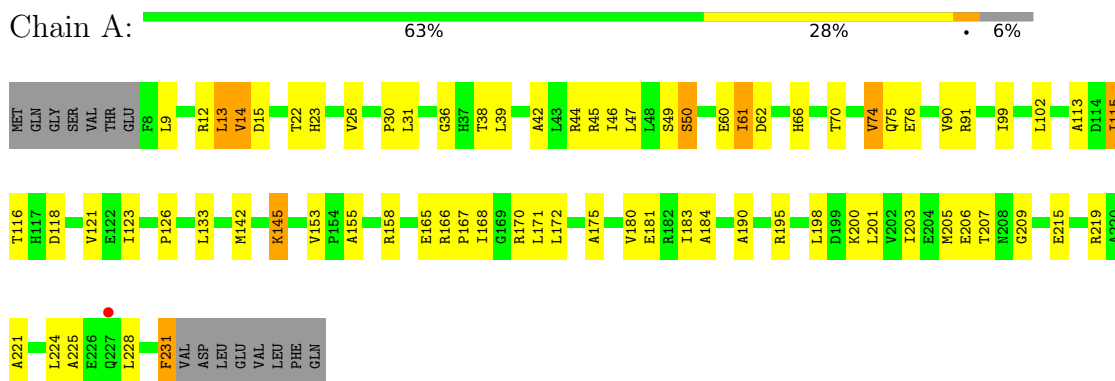

- Molecule 1: DNA-directed RNA polymerase subunit alpha

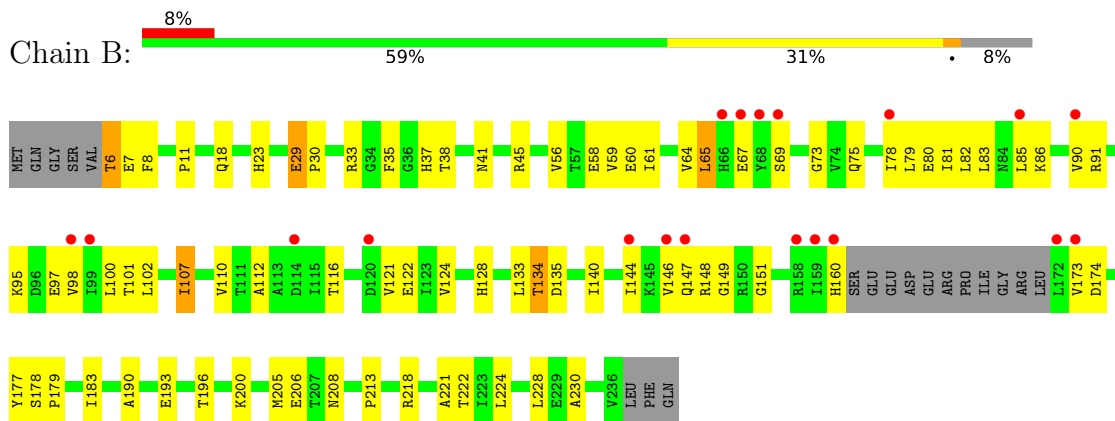

- Molecule 1: DNA-directed RNA polymerase subunit alpha

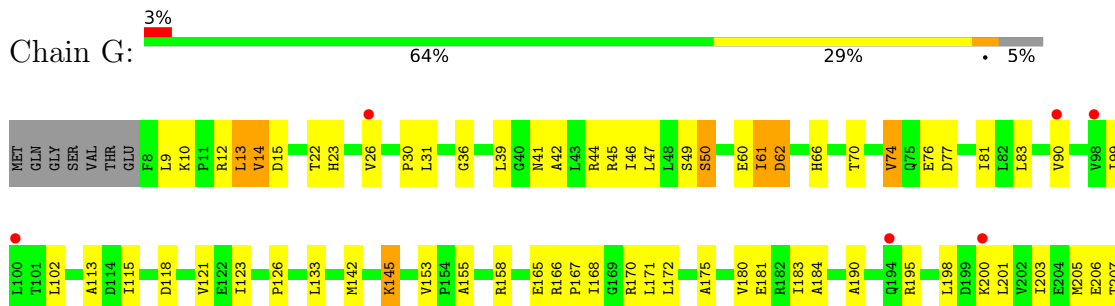



● Molecule 1: DNA-directed RNA polymerase subunit alpha

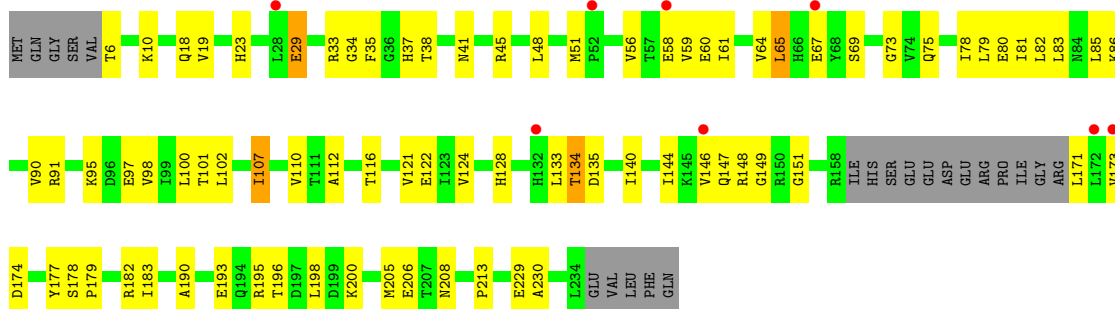

● Molecule 2: DNA-directed RNA polymerase subunit beta

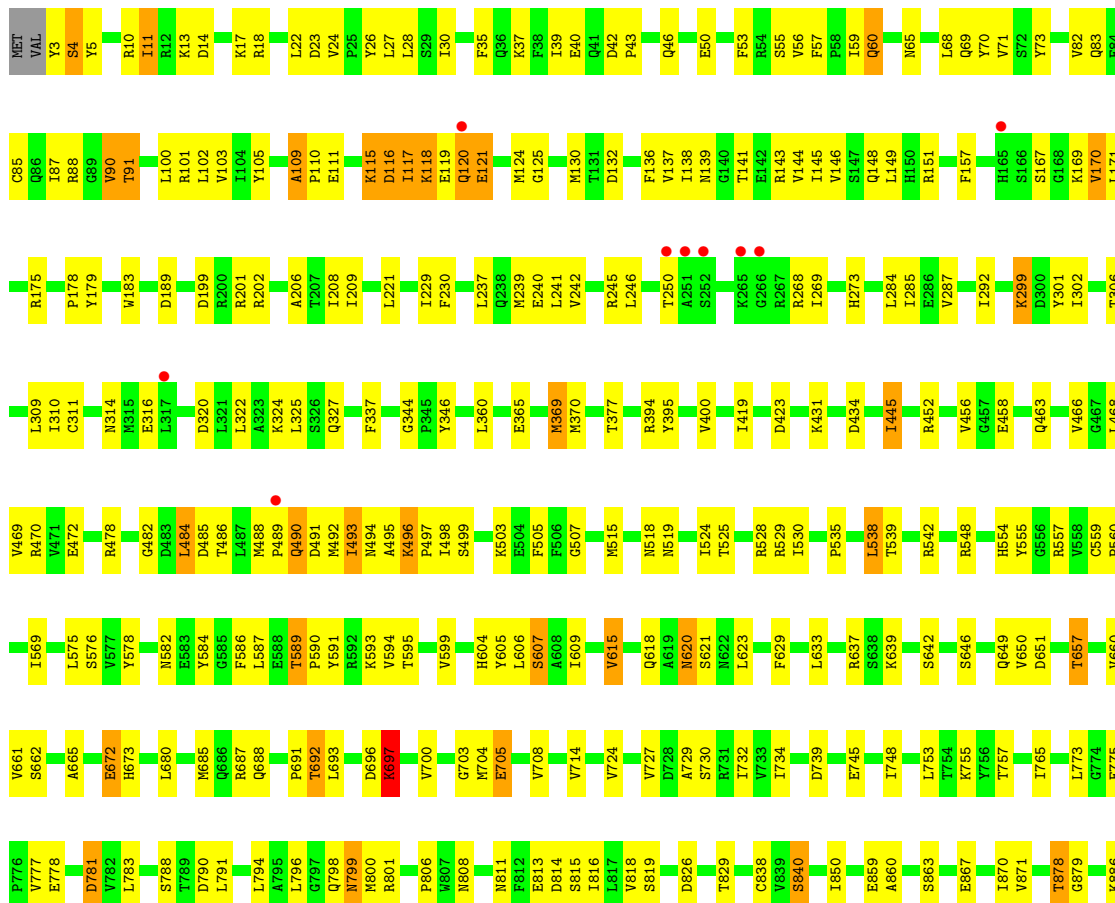

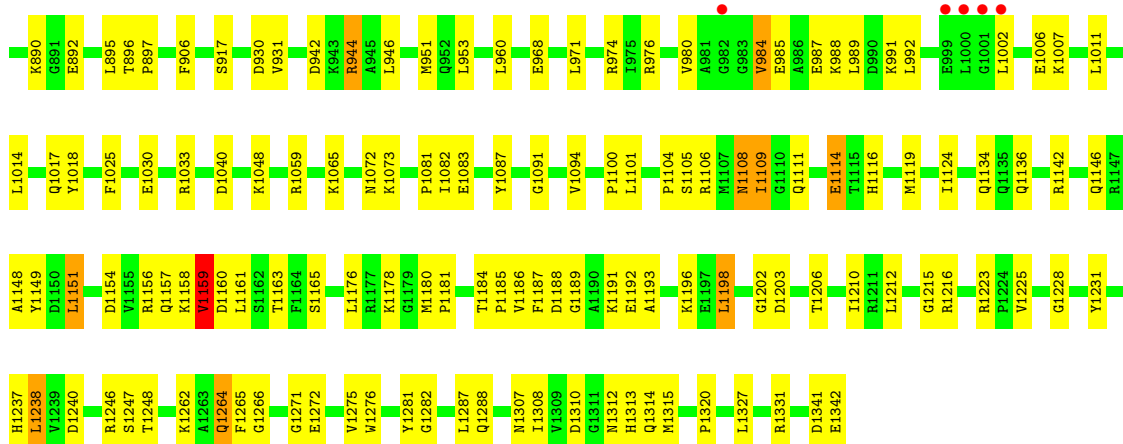

• Molecule 2: DNA-directed RNA polymerase subunit beta

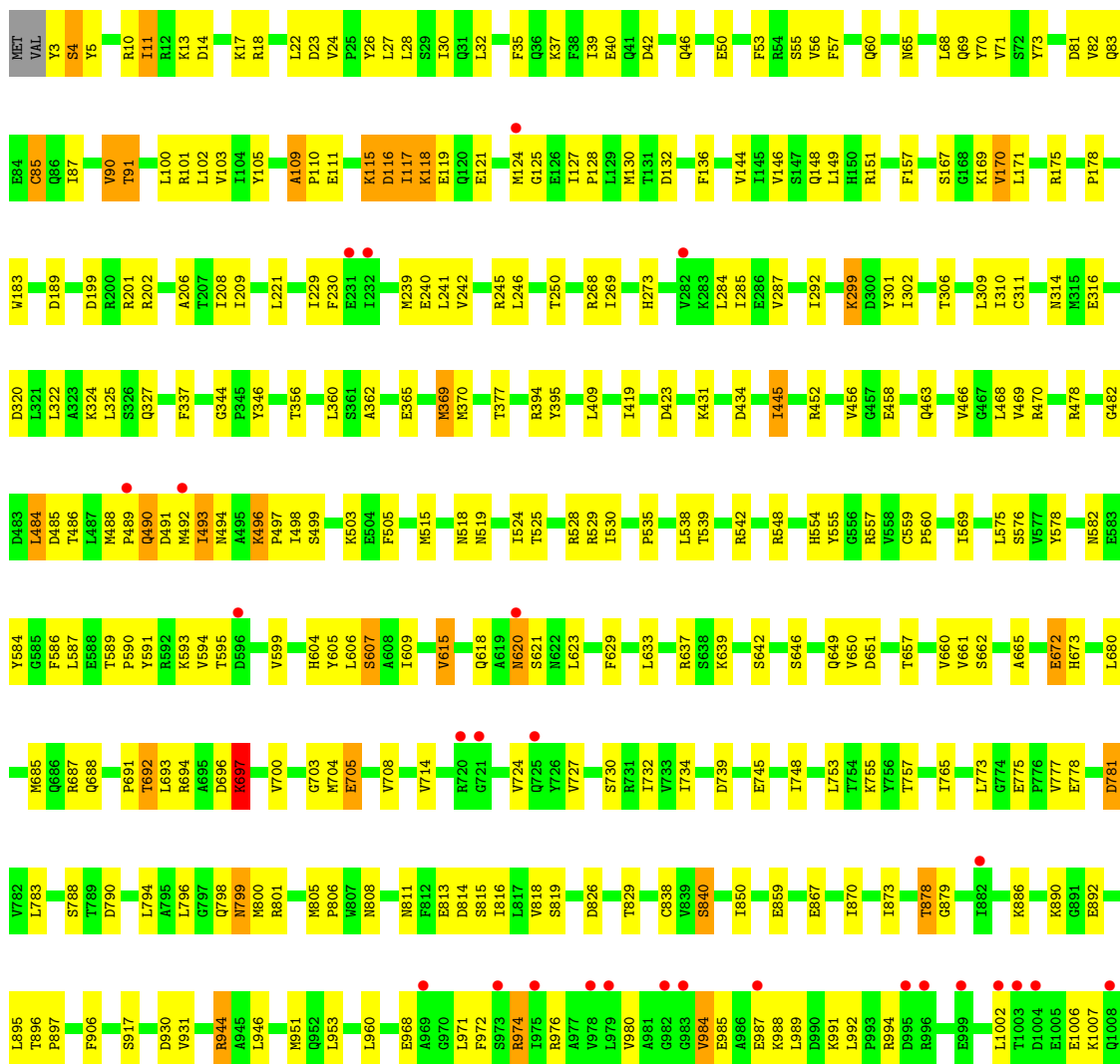

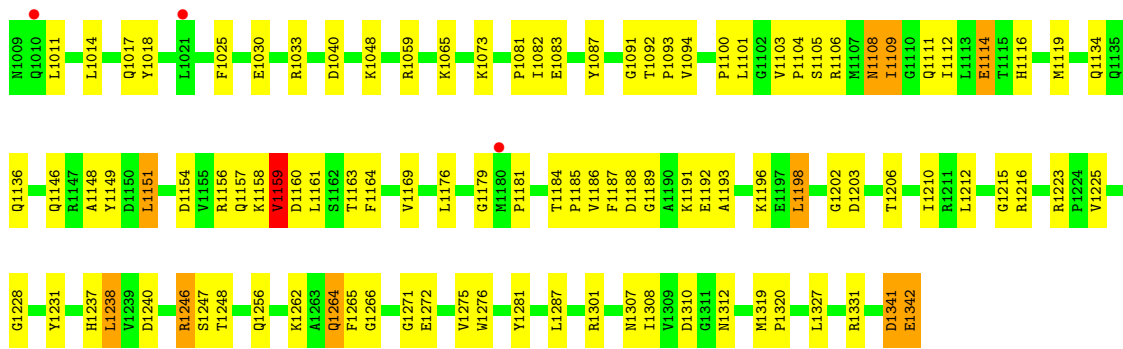

● Molecule 3: DNA-directed RNA polymerase subunit beta'

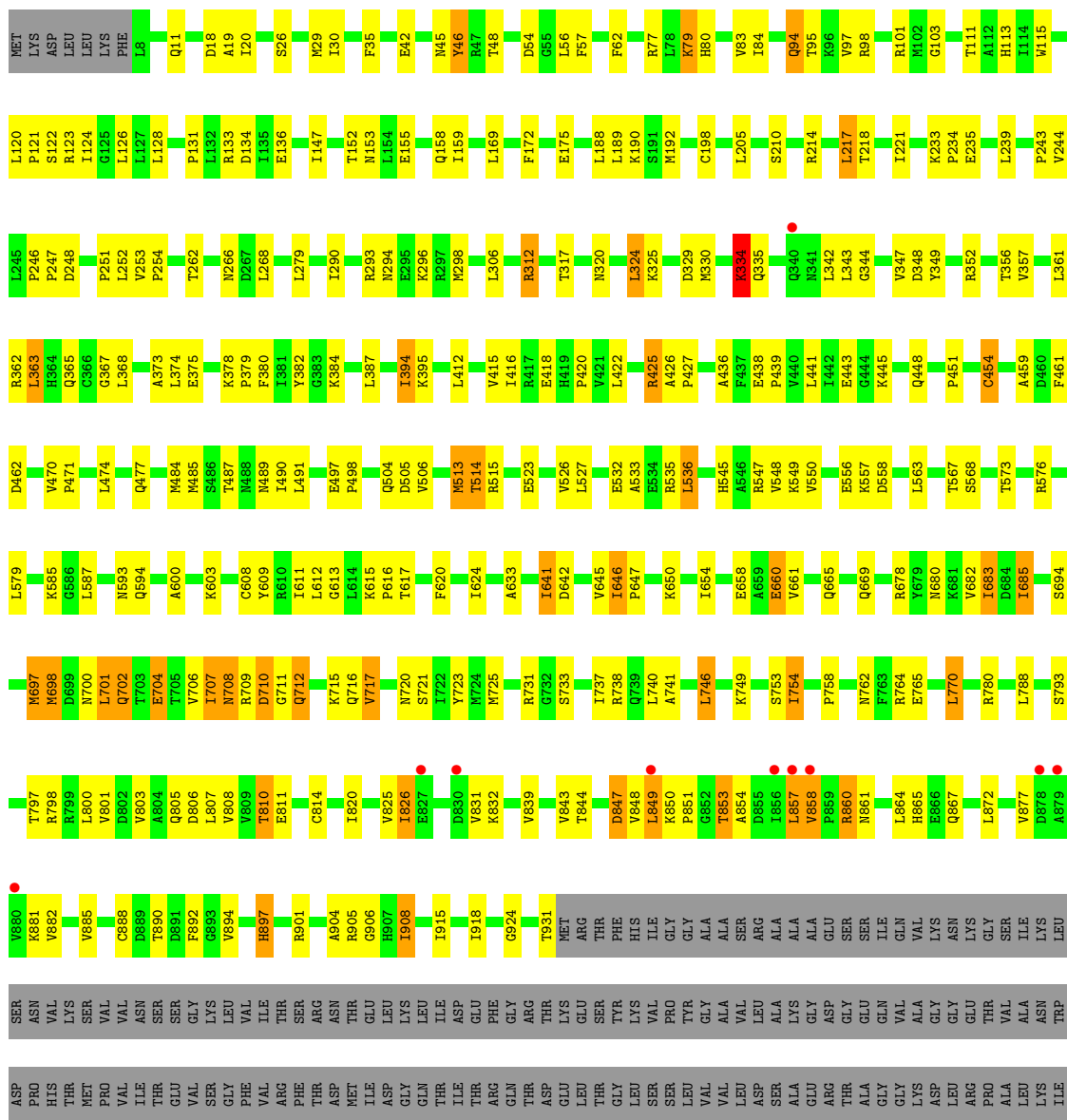

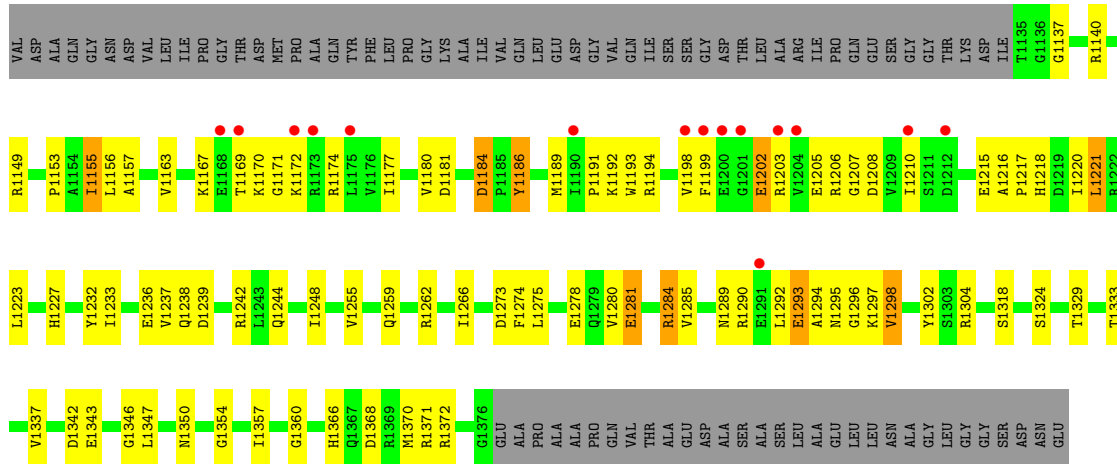

• Molecule 3: DNA-directed RNA polymerase subunit beta'

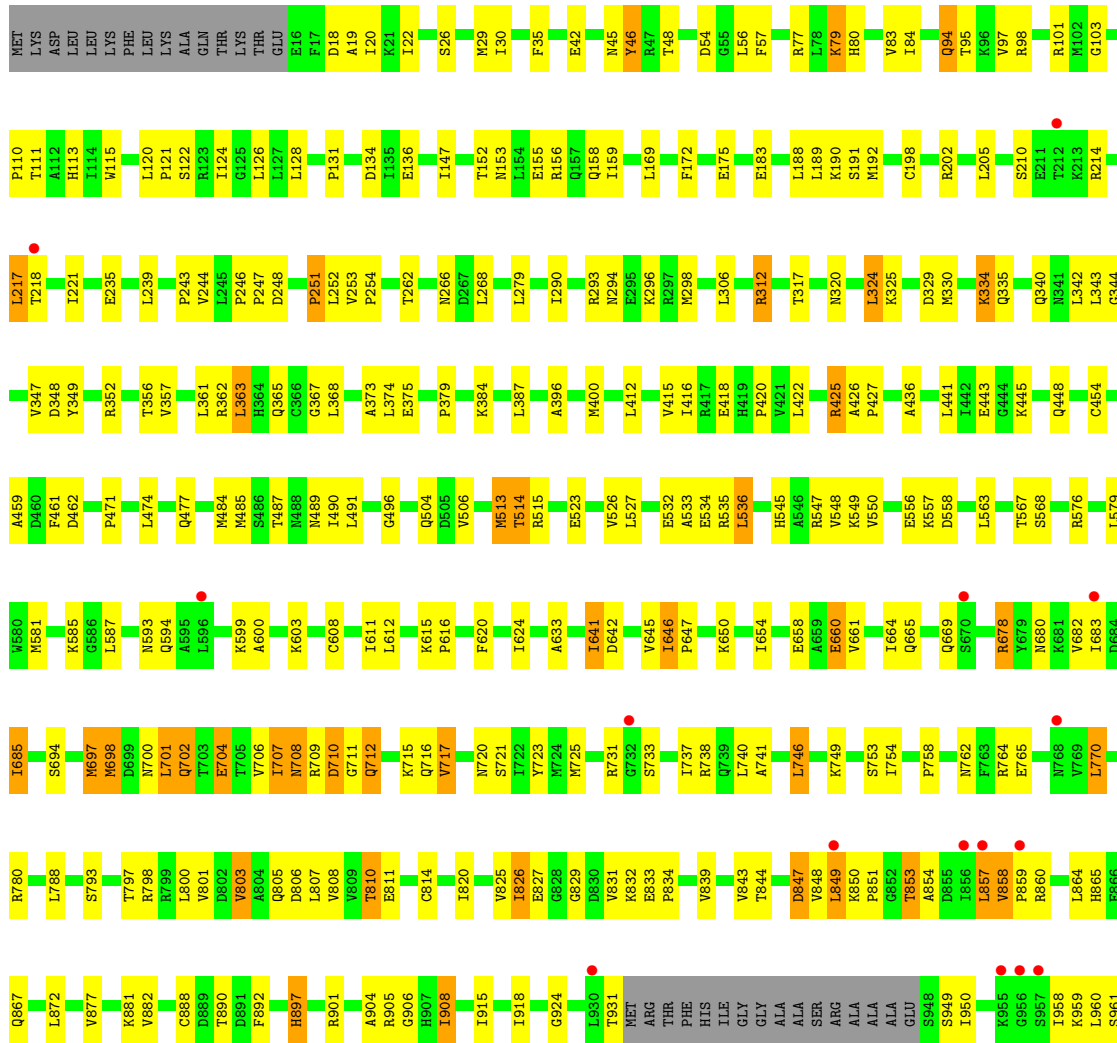

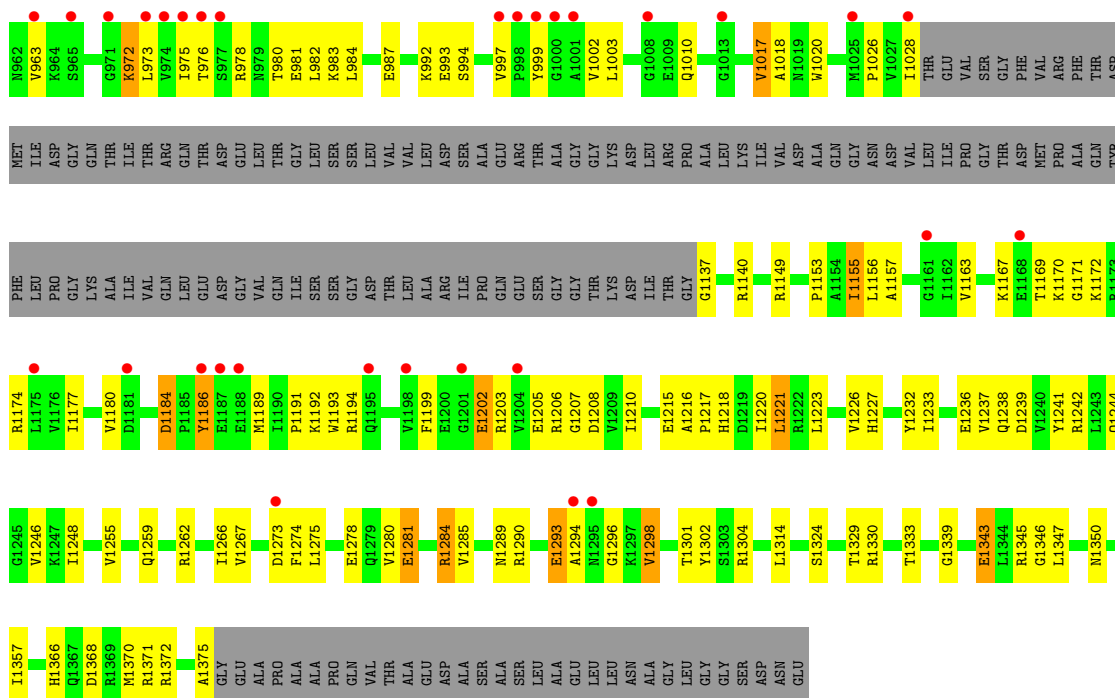

- Molecule 4: DNA-directed RNA polymerase subunit omega

Chain E: 76% 19%

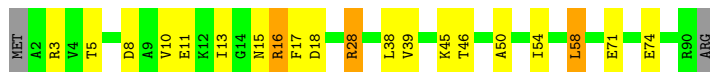

- Molecule 4: DNA-directed RNA polymerase subunit omega

Chain K: 66% 19% 13%

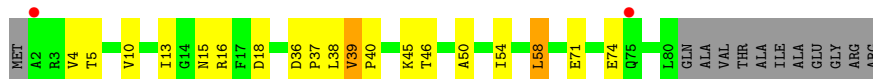

- Molecule 5: RNA polymerase sigma factor RpoD

Chain F: 62% 25% 10%

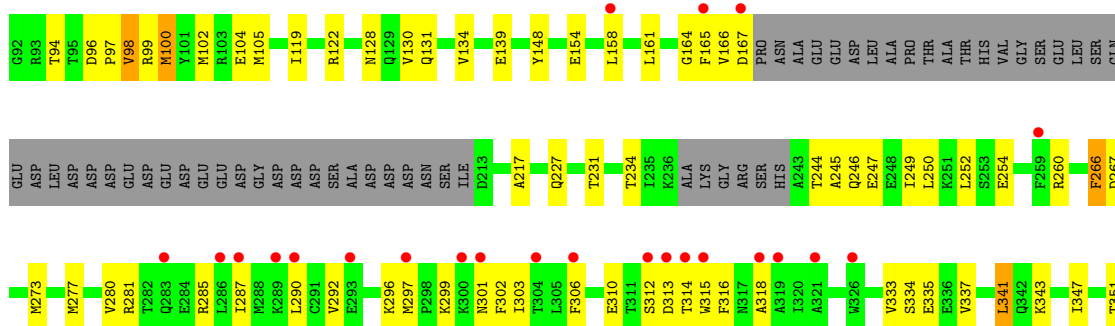

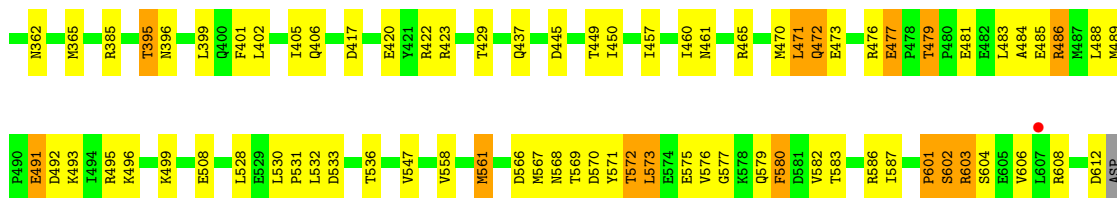

• Molecule 5: RNA polymerase sigma factor RpoD

Chain L: 3% 60% 27% 10%

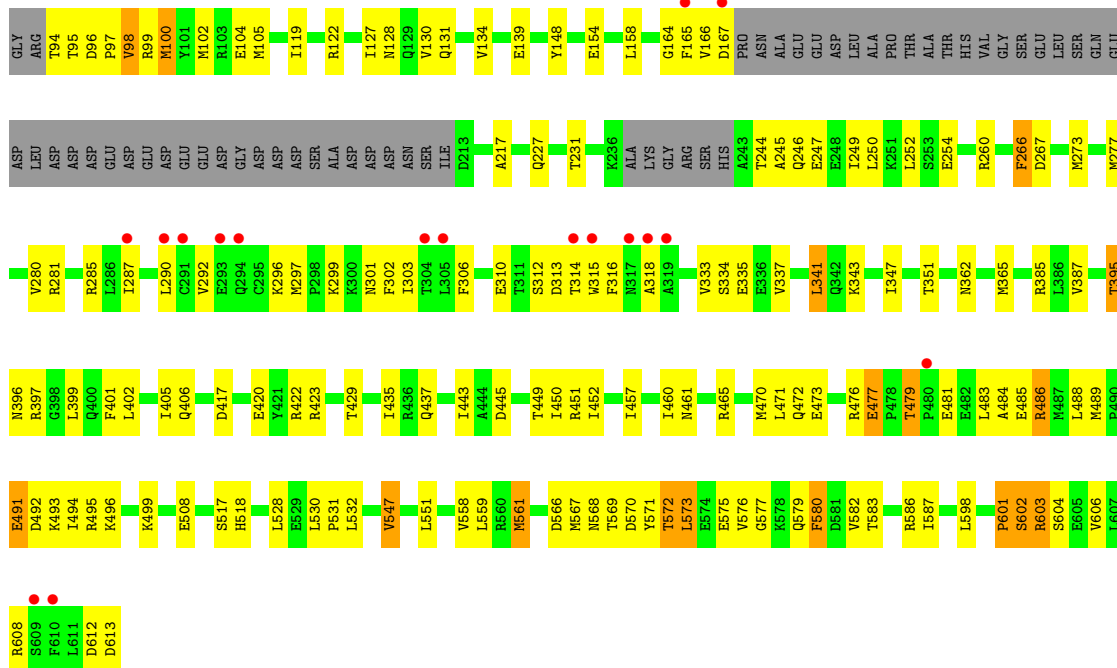

4 Data and refinement statistics

Property	Value	Source
Space group	P 21 21 21	Depositor
Cell constants a, b, c, α , β , γ	187.03Å 206.91Å 310.04Å 90.00° 90.00° 90.00°	Depositor
Resolution (Å)	40.00 – 3.71 40.07 – 3.71	Depositor EDS
% Data completeness (in resolution range)	98.9 (40.00-3.71) 98.9 (40.07-3.71)	Depositor EDS
R_{merge}	0.14	Depositor
R_{sym}	(Not available)	Depositor
$\langle I/\sigma(I) \rangle$ ¹	1.94 (at 3.66Å)	Xtrriage
Refinement program	PHENIX	Depositor
R, R_{free}	0.230 , 0.273 0.230 , 0.273	Depositor DCC
R_{free} test set	6332 reflections (5.02%)	wwPDB-VP
Wilson B-factor (Å ²)	142.3	Xtrriage
Anisotropy	0.346	Xtrriage
Bulk solvent k_{sol} (e/Å ³), B_{sol} (Å ²)	0.26 , 63.8	EDS
L-test for twinning ²	$\langle L \rangle = 0.49$, $\langle L^2 \rangle = 0.33$	Xtrriage
Estimated twinning fraction	No twinning to report.	Xtrriage
F_o, F_c correlation	0.93	EDS
Total number of atoms	55722	wwPDB-VP
Average B, all atoms (Å ²)	102.0	wwPDB-VP

Xtrriage's analysis on translational NCS is as follows: *The largest off-origin peak in the Patterson function is 1.78% of the height of the origin peak. No significant pseudotranslation is detected.*

¹Intensities estimated from amplitudes.

²Theoretical values of $\langle |L| \rangle$, $\langle L^2 \rangle$ for acentric reflections are 0.5, 0.333 respectively for untwinned datasets, and 0.375, 0.2 for perfectly twinned datasets.

5 Model quality

5.1 Standard geometry

Bond lengths and bond angles in the following residue types are not validated in this section: ZN, 42S, MG

The Z score for a bond length (or angle) is the number of standard deviations the observed value is removed from the expected value. A bond length (or angle) with $|Z| > 5$ is considered an outlier worth inspection. RMSZ is the root-mean-square of all Z scores of the bond lengths (or angles).

Mol	Chain	Bond lengths		Bond angles	
		RMSZ	# Z >5	RMSZ	# Z >5
1	A	0.26	0/1751	0.54	0/2373
1	B	0.28	0/1707	0.53	0/2314
1	G	0.27	0/1771	0.55	0/2401
1	H	0.27	0/1686	0.53	0/2285
2	C	0.28	0/10739	0.52	0/14489
2	I	0.28	0/10735	0.51	0/14484
3	D	0.27	0/9246	0.51	1/12478 (0.0%)
3	J	0.27	0/9785	0.50	1/13206 (0.0%)
4	E	0.28	0/693	0.53	0/935
4	K	0.28	0/629	0.51	0/847
5	F	0.30	0/3873	0.51	1/5206 (0.0%)
5	L	0.30	0/3872	0.51	1/5205 (0.0%)
All	All	0.28	0/56487	0.51	4/76223 (0.0%)

Chiral center outliers are detected by calculating the chiral volume of a chiral center and verifying if the center is modelled as a planar moiety or with the opposite hand. A planarity outlier is detected by checking planarity of atoms in a peptide group, atoms in a mainchain group or atoms of a sidechain that are expected to be planar.

Mol	Chain	#Chirality outliers	#Planarity outliers
2	C	0	1
2	I	0	1
3	D	0	2
3	J	0	2
5	F	0	1
5	L	0	1
All	All	0	8

There are no bond length outliers.

All (4) bond angle outliers are listed below:

Mol	Chain	Res	Type	Atoms	Z	Observed(°)	Ideal(°)
5	F	602	SER	N-CA-C	-6.75	92.78	111.00
5	L	602	SER	N-CA-C	-6.54	93.35	111.00
3	D	334	LYS	CB-CG-CD	5.72	126.48	111.60
3	J	334	LYS	CB-CG-CD	5.67	126.34	111.60

There are no chirality outliers.

All (8) planarity outliers are listed below:

Mol	Chain	Res	Type	Group
2	C	109	ALA	Peptide
3	D	1184	ASP	Peptide
3	D	1296	GLY	Peptide
5	F	601	PRO	Peptide
2	I	109	ALA	Peptide
3	J	1184	ASP	Peptide
3	J	1296	GLY	Peptide
5	L	601	PRO	Peptide

5.2 Too-close contacts [i](#)

In the following table, the Non-H and H(model) columns list the number of non-hydrogen atoms and hydrogen atoms in the chain respectively. The H(added) column lists the number of hydrogen atoms added and optimized by MolProbity. The Clashes column lists the number of clashes within the asymmetric unit, whereas Symm-Clashes lists symmetry-related clashes.

Mol	Chain	Non-H	H(model)	H(added)	Clashes	Symm-Clashes
1	A	1730	0	1756	50	0
1	B	1687	0	1700	53	0
1	G	1750	0	1764	45	0
1	H	1667	0	1689	52	0
2	C	10570	0	10582	254	0
2	I	10566	0	10576	237	0
3	D	9107	0	9308	243	0
3	J	9638	0	9853	256	0
4	E	691	0	695	13	0
4	K	627	0	634	10	0
5	F	3822	0	3885	84	0
5	L	3821	0	3884	89	0
6	C	20	0	11	2	0
6	I	20	0	11	2	0
7	D	1	0	0	0	0
7	J	1	0	0	0	0

Continued on next page...

Continued from previous page...

Mol	Chain	Non-H	H(model)	H(added)	Clashes	Symm-Clashes
8	D	2	0	0	0	0
8	J	2	0	0	0	0
All	All	55722	0	56348	1270	0

The all-atom clashscore is defined as the number of clashes found per 1000 atoms (including hydrogen atoms). The all-atom clashscore for this structure is 11.

All (1270) close contacts within the same asymmetric unit are listed below, sorted by their clash magnitude.

Atom-1	Atom-2	Interatomic distance (Å)	Clash overlap (Å)
3:D:660:GLU:HB3	3:D:685:ILE:HD12	1.54	0.90
3:J:660:GLU:HB3	3:J:685:ILE:HD12	1.54	0.90
3:D:418:GLU:HG3	4:E:45:LYS:H	1.41	0.85
2:I:873:ILE:HG13	2:I:944:ARG:HH22	1.42	0.84
3:J:418:GLU:HG3	4:K:45:LYS:H	1.44	0.81
2:I:10:ARG:HD3	2:I:1181:PRO:HG2	1.61	0.81
2:C:69:GLN:HE21	2:C:101:ARG:HD2	1.45	0.81
2:C:10:ARG:HD3	2:C:1181:PRO:HG2	1.62	0.81
2:I:452:ARG:NH1	2:I:584:TYR:O	2.14	0.81
3:J:1171:GLY:HA2	3:J:1193:TRP:HZ3	1.45	0.81
2:C:221:LEU:HD11	2:C:314:ASN:HB2	1.63	0.80
2:I:69:GLN:HE21	2:I:101:ARG:HD2	1.46	0.80
1:B:73:GLY:HA2	1:B:134:THR:HG22	1.63	0.80
3:J:342:LEU:HD11	3:J:1324:SER:HB3	1.64	0.80
1:H:73:GLY:HA2	1:H:134:THR:HG22	1.62	0.79
2:C:673:HIS:HB3	2:C:1109:ILE:HG22	1.64	0.79
2:C:452:ARG:NH1	2:C:584:TYR:O	2.15	0.79
3:D:1171:GLY:HA2	3:D:1193:TRP:HZ3	1.45	0.78
2:I:673:HIS:HB3	2:I:1109:ILE:HG22	1.64	0.78
3:D:853:THR:HG21	3:J:1375:ALA:HB1	1.65	0.78
3:D:342:LEU:HD11	3:D:1324:SER:HB3	1.65	0.77
2:C:1248:THR:HG21	5:F:531:PRO:HG3	1.67	0.76
3:D:1206:ARG:NH2	3:D:1223:LEU:O	2.18	0.76
1:G:190:ALA:HB2	1:G:200:LYS:HB2	1.69	0.75
1:A:190:ALA:HB2	1:A:200:LYS:HB2	1.68	0.75
2:C:18:ARG:NH1	2:C:621:SER:O	2.20	0.75
2:I:18:ARG:NH1	2:I:621:SER:O	2.19	0.74
5:L:97:PRO:HA	5:L:100:MET:HG3	1.69	0.74
2:C:310:ILE:HG21	2:C:325:LEU:HB3	1.71	0.73
5:F:97:PRO:HA	5:F:100:MET:HG3	1.70	0.73
3:D:797:THR:HG22	3:D:924:GLY:HA3	1.70	0.73

Continued on next page...

Continued from previous page...

Atom-1	Atom-2	Interatomic distance (Å)	Clash overlap (Å)
2:I:310:ILE:HG21	2:I:325:LEU:HB3	1.71	0.72
5:F:134:VAL:HG21	5:F:266:PHE:HE1	1.55	0.72
3:J:1026:PRO:HB2	3:J:1028:ILE:HG23	1.72	0.71
2:I:124:MET:HB3	2:I:493:ILE:HD11	1.74	0.70
1:G:226:GLU:HG2	1:H:10:LYS:HE3	1.74	0.70
5:L:134:VAL:HG21	5:L:266:PHE:HE1	1.55	0.70
1:G:45:ARG:NH1	1:H:34:GLY:O	2.25	0.70
2:C:696:ASP:HB2	2:C:798:GLN:HG2	1.75	0.69
1:G:10:LYS:HE2	1:H:229:GLU:HB3	1.75	0.69
3:J:474:LEU:HD12	3:J:477:GLN:HE21	1.59	0.68
3:J:1140:ARG:HH21	3:J:1236:GLU:HG2	1.58	0.68
3:D:1140:ARG:HH21	3:D:1236:GLU:HG2	1.58	0.68
3:D:1297:LYS:HG2	3:J:1302:TYR:O	1.92	0.68
2:C:124:MET:HB3	2:C:493:ILE:HD11	1.75	0.68
3:J:155:GLU:HB2	3:J:158:GLN:HB2	1.76	0.68
2:I:696:ASP:HB2	2:I:798:GLN:HG2	1.75	0.68
2:I:1105:SER:HB2	3:J:731:ARG:HG2	1.76	0.68
2:C:525:THR:HG21	2:C:687:ARG:HD2	1.76	0.68
2:C:103:VAL:HG12	2:C:116:ASP:HB3	1.75	0.67
3:D:474:LEU:HD12	3:D:477:GLN:HE21	1.59	0.67
2:I:525:THR:HG21	2:I:687:ARG:HD2	1.76	0.67
3:J:975:ILE:HD13	3:J:980:THR:HG21	1.76	0.67
2:I:646:SER:HB3	2:I:649:GLN:HG3	1.77	0.67
3:J:576:ARG:NH1	3:J:593:ASN:O	2.28	0.67
2:C:745:GLU:HG3	2:C:1017:GLN:HB3	1.75	0.67
3:D:576:ARG:NH1	3:D:593:ASN:O	2.28	0.67
2:I:103:VAL:HG12	2:I:116:ASP:HB3	1.75	0.67
1:A:224:LEU:HD22	1:B:228:LEU:HD11	1.76	0.67
1:B:90:VAL:HG11	1:B:146:VAL:HG11	1.77	0.67
2:C:1275:VAL:HG13	2:C:1287:LEU:HD11	1.77	0.67
3:D:1203:ARG:HH12	3:D:1205:GLU:HG2	1.60	0.67
2:I:1275:VAL:HG13	2:I:1287:LEU:HD11	1.75	0.66
3:J:978:ARG:HB2	3:J:1199:PHE:HZ	1.59	0.66
3:J:556:GLU:HG2	3:J:558:ASP:HB2	1.77	0.66
3:D:155:GLU:HB2	3:D:158:GLN:HB2	1.76	0.66
3:D:334:LYS:HG3	3:D:335:GLN:H	1.60	0.66
2:C:870:ILE:HB	2:C:944:ARG:HD3	1.77	0.66
2:C:1105:SER:HB2	3:D:731:ARG:HG2	1.78	0.66
2:C:732:ILE:HG21	2:C:783:LEU:HD12	1.78	0.66
3:J:1203:ARG:HH12	3:J:1205:GLU:HG2	1.60	0.66
3:J:963:VAL:HB	3:J:980:THR:HG23	1.77	0.66

Continued on next page...

Continued from previous page...

Atom-1	Atom-2	Interatomic distance (Å)	Clash overlap (Å)
1:H:83:LEU:HA	1:H:86:LYS:HE2	1.78	0.66
2:C:646:SER:HB3	2:C:649:GLN:HG3	1.77	0.65
1:H:59:VAL:O	1:H:171:LEU:N	2.29	0.65
3:J:1206:ARG:NH2	3:J:1223:LEU:O	2.28	0.65
1:A:38:THR:OG1	1:B:45:ARG:NH1	2.29	0.65
3:D:1215:GLU:HG3	3:D:1220:ILE:HD11	1.78	0.65
1:A:166:ARG:O	1:A:168:ILE:N	2.30	0.65
3:D:128:LEU:HD23	3:D:192:MET:HE3	1.77	0.65
2:I:292:ILE:HB	2:I:322:LEU:HD11	1.79	0.65
2:I:452:ARG:NH2	2:I:458:GLU:OE2	2.29	0.65
2:C:1240:ASP:HB3	3:D:445:LYS:HD2	1.78	0.65
3:D:1293:GLU:HG2	3:J:1227:HIS:HB2	1.78	0.65
2:C:591:TYR:OH	2:C:637:ARG:NH2	2.30	0.64
2:I:591:TYR:OH	2:I:637:ARG:NH2	2.30	0.64
1:G:12:ARG:HG3	1:H:230:ALA:HB1	1.79	0.64
5:L:316:PHE:HZ	5:L:334:SER:HA	1.63	0.64
1:G:166:ARG:O	1:G:168:ILE:N	2.30	0.64
1:H:90:VAL:HG11	1:H:146:VAL:HG11	1.80	0.64
3:D:556:GLU:HG2	3:D:558:ASP:HB2	1.77	0.64
3:J:79:LYS:HB2	5:L:569:THR:H	1.63	0.64
2:C:120:GLN:HG3	2:C:121:GLU:HG3	1.80	0.64
1:H:86:LYS:HD3	1:H:174:ASP:HB2	1.80	0.64
2:C:1119:MET:HB2	2:C:1228:GLY:HA2	1.80	0.64
2:I:1119:MET:HB2	2:I:1228:GLY:HA2	1.79	0.63
2:I:732:ILE:HG21	2:I:783:LEU:HD12	1.78	0.63
1:B:83:LEU:HA	1:B:86:LYS:HE2	1.79	0.63
3:J:1215:GLU:HG3	3:J:1220:ILE:HD11	1.80	0.63
1:B:86:LYS:HD3	1:B:174:ASP:HB2	1.81	0.63
2:C:292:ILE:HB	2:C:322:LEU:HD11	1.79	0.63
2:C:1191:LYS:HD3	2:C:1193:ALA:H	1.64	0.63
3:D:650:LYS:HE2	3:D:654:ILE:HD11	1.81	0.63
5:F:316:PHE:HZ	5:F:334:SER:HA	1.63	0.63
2:C:10:ARG:NH2	2:C:790:ASP:OD2	2.32	0.63
3:J:128:LEU:HD23	3:J:192:MET:HE3	1.80	0.63
3:J:1157:ALA:HB2	3:J:1210:ILE:HD11	1.81	0.63
2:C:138:ILE:HB	2:C:143:ARG:HD3	1.81	0.62
1:A:31:LEU:HD11	1:A:201:LEU:HB2	1.81	0.62
1:H:100:LEU:HD11	1:H:121:VAL:HG21	1.82	0.62
2:I:221:LEU:HD11	2:I:314:ASN:HB2	1.82	0.62
1:A:12:ARG:HG3	1:B:230:ALA:HB1	1.82	0.62
1:B:33:ARG:HH11	2:C:1081:PRO:HG3	1.64	0.62

Continued on next page...

Continued from previous page...

Atom-1	Atom-2	Interatomic distance (Å)	Clash overlap (Å)
3:D:854:ALA:HB2	3:J:1372:ARG:HB2	1.81	0.62
3:J:650:LYS:HE2	3:J:654:ILE:HD11	1.80	0.62
2:C:987:GLU:HG2	2:C:991:LYS:HE3	1.81	0.62
3:J:491:LEU:HB2	3:J:904:ALA:HA	1.80	0.62
3:J:961:SER:HB2	3:J:981:GLU:HB3	1.81	0.62
2:I:10:ARG:NH2	2:I:790:ASP:OD2	2.32	0.62
1:B:98:VAL:HG11	1:B:121:VAL:HG22	1.81	0.62
2:C:559:CYS:HB2	2:C:662:SER:HB3	1.82	0.62
3:D:136:GLU:OE2	3:D:312:ARG:NH1	2.33	0.62
3:D:1157:ALA:HB2	3:D:1210:ILE:HD11	1.81	0.62
2:I:745:GLU:HG3	2:I:1017:GLN:HB3	1.81	0.62
2:I:987:GLU:HG2	2:I:991:LYS:HE3	1.82	0.62
2:I:1191:LYS:HD3	2:I:1193:ALA:H	1.65	0.61
3:D:262:THR:OG1	3:D:266:ASN:ND2	2.33	0.61
3:J:136:GLU:OE2	3:J:312:ARG:NH1	2.33	0.61
3:J:262:THR:OG1	3:J:266:ASN:ND2	2.32	0.61
2:I:1101:LEU:HD13	3:J:504:GLN:HB2	1.82	0.61
2:C:1185:PRO:HB2	2:C:1188:ASP:HB3	1.83	0.61
5:L:277:MET:HG3	5:L:362:ASN:HD21	1.65	0.61
2:C:136:PHE:O	2:C:143:ARG:N	2.30	0.61
3:D:1199:PHE:HB2	3:D:1202:GLU:HB2	1.83	0.61
1:A:70:THR:HG21	2:C:755:LYS:HE2	1.82	0.60
5:F:277:MET:HG3	5:F:362:ASN:HD21	1.65	0.60
2:C:1101:LEU:HD13	3:D:504:GLN:HB2	1.83	0.60
2:I:985:GLU:HB3	2:I:988:LYS:HB2	1.83	0.60
1:B:100:LEU:HD11	1:B:121:VAL:HG21	1.81	0.60
2:I:30:ILE:HD12	2:I:30:ILE:H	1.65	0.60
3:D:527:LEU:HD23	3:D:532:GLU:HG3	1.83	0.60
1:G:31:LEU:HD11	1:G:201:LEU:HB2	1.82	0.60
2:I:499:SER:O	2:I:503:LYS:HB2	2.02	0.60
3:J:527:LEU:HD23	3:J:532:GLU:HG3	1.84	0.60
5:L:128:ASN:HA	5:L:131:GLN:HE21	1.66	0.60
4:K:15:ASN:HB3	4:K:18:ASP:HB2	1.83	0.60
2:C:985:GLU:HB3	2:C:988:LYS:HB2	1.83	0.59
1:A:26:VAL:HG22	1:A:203:ILE:HB	1.85	0.59
1:A:225:ALA:HA	1:A:228:LEU:HD23	1.83	0.59
2:I:1240:ASP:HB3	3:J:445:LYS:HD2	1.84	0.59
1:A:184:ALA:HB2	2:C:1091:GLY:HA3	1.83	0.59
2:C:1272:GLU:HB2	3:D:342:LEU:O	2.02	0.59
3:J:1199:PHE:HB2	3:J:1202:GLU:HB2	1.84	0.59
1:H:98:VAL:HG11	1:H:121:VAL:HG22	1.83	0.59

Continued on next page...

Continued from previous page...

Atom-1	Atom-2	Interatomic distance (Å)	Clash overlap (Å)
3:J:960:LEU:HB3	3:J:963:VAL:HG11	1.83	0.59
1:G:70:THR:HG21	2:I:755:LYS:HE2	1.85	0.59
2:I:1185:PRO:HB2	2:I:1188:ASP:HB3	1.83	0.59
2:C:88:ARG:NE	2:C:1040:ASP:OD1	2.27	0.59
5:F:577:GLY:HA3	5:F:583:THR:HG23	1.84	0.59
1:A:45:ARG:NH2	2:C:1216:ARG:HA	2.17	0.58
2:C:499:SER:O	2:C:503:LYS:HB2	2.03	0.58
2:C:1196:LYS:HD2	2:C:1206:THR:HG23	1.85	0.58
3:J:650:LYS:NZ	3:J:765:GLU:OE2	2.35	0.58
3:D:205:LEU:HD23	3:D:217:LEU:HB3	1.86	0.58
3:D:650:LYS:NZ	3:D:765:GLU:OE2	2.35	0.58
2:I:705:GLU:HB2	2:I:794:LEU:H	1.68	0.58
2:I:1149:TYR:CD1	2:I:1159:VAL:HG11	2.39	0.58
1:G:26:VAL:HG22	1:G:203:ILE:HB	1.84	0.58
2:I:1196:LYS:HD2	2:I:1206:THR:HG23	1.86	0.58
3:J:1169:THR:HG23	3:J:1192:LYS:HD3	1.86	0.58
5:L:577:GLY:HA3	5:L:583:THR:HG23	1.84	0.58
2:C:705:GLU:HB2	2:C:794:LEU:H	1.68	0.58
2:I:930:ASP:OD2	2:I:931:VAL:N	2.37	0.58
3:D:334:LYS:CG	3:D:335:GLN:H	2.17	0.58
2:I:806:PRO:HA	2:I:811:ASN:HD21	1.67	0.58
3:J:293:ARG:NH1	5:L:104:GLU:OE2	2.35	0.58
2:C:1149:TYR:CD1	2:C:1159:VAL:HG11	2.39	0.58
5:F:343:LYS:HD2	5:F:343:LYS:H	1.68	0.58
2:C:806:PRO:HA	2:C:811:ASN:HD21	1.67	0.58
3:D:1171:GLY:HA2	3:D:1193:TRP:CZ3	2.34	0.58
3:J:425:ARG:HE	3:J:427:PRO:HD2	1.69	0.58
1:B:95:LYS:HZ3	1:B:98:VAL:HG23	1.68	0.58
3:D:334:LYS:HG3	3:D:335:GLN:N	2.18	0.58
2:C:242:VAL:HB	2:C:245:ARG:HD2	1.85	0.57
3:D:293:ARG:NH1	5:F:104:GLU:OE2	2.35	0.57
1:G:12:ARG:H	1:G:30:PRO:HD2	1.69	0.57
1:G:60:GLU:HB2	1:G:170:ARG:HG2	1.85	0.57
1:A:231:PHE:CZ	1:B:221:ALA:HB3	2.39	0.57
2:C:930:ASP:OD2	2:C:931:VAL:N	2.37	0.57
2:C:1313:HIS:HB2	3:D:474:LEU:HD13	1.84	0.57
3:D:749:LYS:HD3	3:D:753:SER:HB2	1.86	0.57
1:G:225:ALA:HA	1:G:228:LEU:HD23	1.86	0.57
1:H:82:LEU:HD22	1:H:173:VAL:HG22	1.86	0.57
1:H:101:THR:H	1:H:116:THR:HG22	1.69	0.57
3:J:205:LEU:HD23	3:J:217:LEU:HB3	1.86	0.57

Continued on next page...

Continued from previous page...

Atom-1	Atom-2	Interatomic distance (Å)	Clash overlap (Å)
2:C:148:GLN:NE2	2:C:535:PRO:O	2.33	0.57
2:I:734:ILE:HD11	2:I:783:LEU:HD11	1.85	0.57
2:I:971:LEU:HG	2:I:1014:LEU:HD23	1.86	0.57
1:A:60:GLU:HB2	1:A:170:ARG:HG2	1.84	0.57
1:B:82:LEU:HD22	1:B:173:VAL:HG22	1.87	0.57
2:C:703:GLY:N	2:C:705:GLU:OE2	2.36	0.57
1:G:23:HIS:HB2	1:G:205:MET:O	2.04	0.57
3:D:1280:VAL:HG11	3:D:1304:ARG:HH21	1.68	0.57
1:G:31:LEU:HD13	1:G:36:GLY:HA2	1.86	0.57
3:J:958:ILE:HG23	3:J:982:LEU:HD11	1.87	0.57
5:L:547:VAL:HG23	5:L:603:ARG:HH11	1.69	0.57
1:B:64:VAL:HG21	1:B:69:SER:HB3	1.87	0.57
2:C:109:ALA:HB1	2:C:110:PRO:C	2.24	0.57
1:B:101:THR:H	1:B:116:THR:HG22	1.69	0.57
3:D:425:ARG:HE	3:D:427:PRO:HD2	1.69	0.57
5:F:395:THR:OG1	5:F:396:ASN:N	2.38	0.57
2:I:242:VAL:HB	2:I:245:ARG:HD2	1.85	0.57
2:I:578:TYR:HB3	2:I:590:PRO:HG2	1.87	0.57
5:L:395:THR:OG1	5:L:396:ASN:N	2.38	0.57
1:A:12:ARG:H	1:A:30:PRO:HD2	1.69	0.57
5:L:343:LYS:H	5:L:343:LYS:HD2	1.69	0.57
3:J:532:GLU:HA	3:J:535:ARG:HB3	1.87	0.56
2:C:13:LYS:HZ3	2:C:1151:LEU:HD12	1.69	0.56
5:F:420:GLU:OE1	5:F:423:ARG:NH2	2.32	0.56
2:I:559:CYS:HB2	2:I:662:SER:HB3	1.85	0.56
3:J:905:ARG:HH11	4:K:16:ARG:HD2	1.69	0.56
2:C:30:ILE:HD12	2:C:30:ILE:H	1.69	0.56
3:D:585:LYS:HB2	3:D:612:LEU:HD21	1.88	0.56
3:D:1156:LEU:HB3	3:D:1207:GLY:HA2	1.88	0.56
1:G:181:GLU:HB3	1:G:206:GLU:HG3	1.87	0.56
3:J:42:GLU:CG	5:L:451:ARG:HE	2.18	0.56
1:A:155:ALA:HA	1:A:158:ARG:HG3	1.88	0.56
3:D:218:THR:HA	3:D:221:ILE:HG22	1.88	0.56
1:H:33:ARG:HH11	2:I:1081:PRO:HG3	1.69	0.56
2:I:324:LYS:O	2:I:327:GLN:NE2	2.38	0.56
2:I:560:PRO:O	3:J:780:ARG:NH2	2.39	0.56
3:J:1149:ARG:CZ	3:J:1153:PRO:HG2	2.36	0.56
2:C:971:LEU:HG	2:C:1014:LEU:HD23	1.86	0.56
3:J:797:THR:HG22	3:J:924:GLY:HA3	1.86	0.56
2:C:324:LYS:O	2:C:327:GLN:NE2	2.38	0.56
2:C:734:ILE:HD11	2:C:783:LEU:HD11	1.86	0.56

Continued on next page...

Continued from previous page...

Atom-1	Atom-2	Interatomic distance (Å)	Clash overlap (Å)
3:D:557:LYS:HA	3:D:563:LEU:HA	1.88	0.56
5:F:561:MET:HA	5:F:567:MET:HE1	1.88	0.56
3:J:557:LYS:HA	3:J:563:LEU:HA	1.88	0.56
3:D:190:LYS:HD3	3:D:235:GLU:HG2	1.87	0.56
3:J:749:LYS:HD3	3:J:753:SER:HB2	1.87	0.56
3:J:1216:ALA:HB1	3:J:1218:HIS:HD2	1.69	0.56
2:I:71:VAL:HG21	2:I:118:LYS:HE2	1.88	0.56
2:I:528:ARG:NH2	2:I:576:SER:O	2.38	0.56
2:C:495:ALA:HB3	5:F:471:LEU:HD13	1.88	0.56
2:C:685:MET:HA	2:C:688:GLN:HE21	1.71	0.56
2:C:980:VAL:O	2:C:984:VAL:HB	2.06	0.56
3:D:532:GLU:HA	3:D:535:ARG:HB3	1.88	0.56
2:I:813:GLU:HB2	3:J:461:PHE:HB2	1.88	0.56
3:J:585:LYS:HB2	3:J:612:LEU:HD21	1.87	0.56
2:C:578:TYR:HB3	2:C:590:PRO:HG2	1.87	0.55
1:B:95:LYS:NZ	1:B:98:VAL:HG23	2.20	0.55
1:H:182:ARG:NH1	3:J:581:MET:SD	2.79	0.55
2:I:685:MET:HA	2:I:688:GLN:HE21	1.72	0.55
2:I:657:THR:HG21	2:I:1188:ASP:HB2	1.87	0.55
2:I:1149:TYR:HD1	2:I:1159:VAL:HG11	1.71	0.55
4:K:71:GLU:HA	4:K:74:GLU:HG3	1.88	0.55
5:L:484:ALA:HB1	5:L:491:GLU:HB2	1.88	0.55
1:B:64:VAL:HG12	1:B:65:LEU:H	1.70	0.55
3:D:1169:THR:HG23	3:D:1192:LYS:HD3	1.86	0.55
2:C:71:VAL:HG21	2:C:118:LYS:HE2	1.87	0.55
2:C:757:THR:HG23	2:C:765:ILE:HG23	1.89	0.55
2:C:808:ASN:H	3:D:633:ALA:HB2	1.72	0.55
3:D:642:ASP:HA	3:D:764:ARG:HH21	1.71	0.55
1:G:155:ALA:HA	1:G:158:ARG:HG3	1.87	0.55
2:I:980:VAL:O	2:I:984:VAL:HB	2.06	0.55
1:A:31:LEU:HD13	1:A:36:GLY:HA2	1.88	0.55
2:C:657:THR:HG21	2:C:1188:ASP:HB2	1.89	0.55
2:I:13:LYS:HZ3	2:I:1151:LEU:HD12	1.72	0.55
2:I:757:THR:HG23	2:I:765:ILE:HG23	1.89	0.55
3:J:190:LYS:HD3	3:J:235:GLU:HG2	1.88	0.55
3:J:218:THR:HA	3:J:221:ILE:HG22	1.88	0.55
2:C:528:ARG:NH2	2:C:576:SER:O	2.38	0.55
2:C:813:GLU:HB2	3:D:461:PHE:HB2	1.89	0.55
5:F:402:LEU:HA	5:F:405:ILE:HG12	1.89	0.55
5:F:484:ALA:HB1	5:F:491:GLU:HB2	1.89	0.55
3:J:349:TYR:HE2	3:J:379:PRO:HG2	1.72	0.55

Continued on next page...

Continued from previous page...

Atom-1	Atom-2	Interatomic distance (Å)	Clash overlap (Å)
5:L:127:ILE:O	5:L:130:VAL:HG22	2.06	0.55
2:I:148:GLN:NE2	2:I:535:PRO:O	2.32	0.55
3:J:1280:VAL:HG11	3:J:1304:ARG:HH21	1.71	0.55
1:H:64:VAL:HG12	1:H:65:LEU:H	1.71	0.55
2:I:149:LEU:HB2	2:I:530:ILE:HG22	1.88	0.55
2:I:1272:GLU:HB2	3:J:342:LEU:O	2.07	0.55
1:A:23:HIS:HB2	1:A:205:MET:O	2.05	0.54
2:C:68:LEU:HD11	2:C:100:LEU:HB3	1.89	0.54
3:D:349:TYR:HE2	3:D:379:PRO:HG2	1.72	0.54
3:J:682:VAL:O	3:J:685:ILE:HG12	2.07	0.54
3:J:700:ASN:O	3:J:704:GLU:HB2	2.07	0.54
2:C:241:LEU:HD21	2:C:246:LEU:HD11	1.88	0.54
3:D:1227:HIS:HD2	3:J:1293:GLU:H	1.55	0.54
2:I:808:ASN:H	3:J:633:ALA:HB2	1.73	0.54
5:L:315:TRP:HZ2	5:L:341:LEU:HD21	1.72	0.54
3:D:611:ILE:HG22	3:D:612:LEU:HD12	1.89	0.54
5:F:315:TRP:HZ2	5:F:341:LEU:HD21	1.72	0.54
3:J:611:ILE:HG22	3:J:612:LEU:HD12	1.89	0.54
1:A:14:VAL:HG22	1:A:15:ASP:H	1.72	0.54
2:C:145:ILE:HB	2:C:456:VAL:HG22	1.89	0.54
2:C:560:PRO:O	3:D:780:ARG:NH2	2.40	0.54
3:D:394:ILE:HG23	5:F:536:THR:HG22	1.89	0.54
3:J:642:ASP:HA	3:J:764:ARG:HH21	1.72	0.54
3:J:1156:LEU:HB3	3:J:1207:GLY:HA2	1.88	0.54
1:H:64:VAL:HG21	1:H:69:SER:HB3	1.88	0.54
2:I:241:LEU:HD21	2:I:246:LEU:HD11	1.88	0.54
2:I:778:GLU:O	2:I:781:ASP:HB2	2.07	0.54
3:J:654:ILE:O	3:J:658:GLU:HB2	2.08	0.54
2:I:878:THR:OG1	2:I:879:GLY:N	2.39	0.54
3:J:1280:VAL:O	3:J:1284:ARG:HB3	2.08	0.54
1:A:181:GLU:HB3	1:A:206:GLU:HG3	1.88	0.54
2:C:1116:HIS:HE1	3:D:641:ILE:H	1.56	0.54
4:E:10:VAL:HG13	4:E:16:ARG:HB2	1.90	0.54
1:G:45:ARG:NH2	2:I:1216:ARG:HA	2.22	0.54
2:C:149:LEU:HB2	2:C:530:ILE:HG22	1.89	0.54
2:C:302:ILE:HG22	2:C:309:LEU:HA	1.90	0.54
2:C:1149:TYR:HD1	2:C:1159:VAL:HG11	1.71	0.54
2:I:68:LEU:HD11	2:I:100:LEU:HB3	1.89	0.54
3:J:514:THR:HB	3:J:576:ARG:HG2	1.90	0.54
3:J:901:ARG:HA	3:J:908:ILE:HA	1.89	0.54
2:C:778:GLU:O	2:C:781:ASP:HB2	2.08	0.53

Continued on next page...

Continued from previous page...

Atom-1	Atom-2	Interatomic distance (Å)	Clash overlap (Å)
3:D:700:ASN:O	3:D:704:GLU:HB2	2.08	0.53
3:D:1290:ARG:HG2	3:D:1298:VAL:HG12	1.89	0.53
1:H:95:LYS:NZ	1:H:98:VAL:HG23	2.23	0.53
5:L:561:MET:HA	5:L:567:MET:HE1	1.89	0.53
2:C:878:THR:OG1	2:C:879:GLY:N	2.38	0.53
3:D:1216:ALA:HB1	3:D:1218:HIS:HD2	1.73	0.53
3:D:1217:PRO:HG3	3:D:1232:TYR:HE2	1.73	0.53
3:D:1239:ASP:OD1	3:D:1242:ARG:NH2	2.41	0.53
2:I:703:GLY:N	2:I:705:GLU:OE2	2.38	0.53
3:J:1290:ARG:HG2	3:J:1298:VAL:HG12	1.89	0.53
2:C:4:SER:OG	2:C:5:TYR:N	2.41	0.53
3:D:682:VAL:O	3:D:685:ILE:HG12	2.08	0.53
3:D:707:ILE:HD11	3:D:716:GLN:HG2	1.90	0.53
3:D:514:THR:HB	3:D:576:ARG:HG2	1.90	0.53
3:D:901:ARG:HA	3:D:908:ILE:HA	1.90	0.53
3:J:1239:ASP:OD1	3:J:1242:ARG:NH2	2.42	0.53
5:L:94:THR:OG1	5:L:95:THR:N	2.41	0.53
2:C:1287:LEU:HD22	3:D:1357:ILE:HD11	1.91	0.53
3:D:654:ILE:O	3:D:658:GLU:HB2	2.08	0.53
3:D:1280:VAL:O	3:D:1284:ARG:HB3	2.08	0.53
2:I:302:ILE:HG22	2:I:309:LEU:HA	1.90	0.53
3:J:707:ILE:HD11	3:J:716:GLN:HG2	1.91	0.53
1:B:101:THR:HG22	1:B:116:THR:HB	1.91	0.53
3:D:80:HIS:HB3	3:D:83:VAL:HG11	1.90	0.53
3:D:489:ASN:HA	3:D:904:ALA:HB1	1.90	0.53
2:I:1116:HIS:HE1	3:J:641:ILE:H	1.57	0.53
3:J:80:HIS:HB3	3:J:83:VAL:HG11	1.90	0.53
3:D:147:ILE:HG22	3:D:188:LEU:HG	1.91	0.53
2:I:230:PHE:HE1	2:I:287:VAL:HG21	1.73	0.53
3:J:210:SER:O	3:J:214:ARG:HG2	2.08	0.53
3:J:1217:PRO:HG3	3:J:1232:TYR:HE2	1.73	0.52
5:L:402:LEU:HA	5:L:405:ILE:HG12	1.90	0.52
5:L:479:THR:HG23	5:L:481:GLU:H	1.74	0.52
2:C:230:PHE:HE1	2:C:287:VAL:HG21	1.74	0.52
2:C:519:ASN:HD21	2:C:796:LEU:HD23	1.74	0.52
3:D:111:THR:O	3:D:239:LEU:N	2.39	0.52
3:D:210:SER:O	3:D:214:ARG:HG2	2.09	0.52
2:I:672:GLU:HG2	2:I:1187:PHE:HA	1.91	0.52
2:I:1287:LEU:HD22	3:J:1357:ILE:HD11	1.91	0.52
3:J:412:LEU:HA	3:J:415:VAL:HG22	1.92	0.52
3:J:335:GLN:HG2	3:J:343:LEU:HD11	1.92	0.52

Continued on next page...

Continued from previous page...

Atom-1	Atom-2	Interatomic distance (Å)	Clash overlap (Å)
3:J:847:ASP:OD1	3:J:847:ASP:N	2.31	0.52
3:J:1171:GLY:HA2	3:J:1193:TRP:CZ3	2.35	0.52
5:F:573:LEU:H	5:F:573:LEU:HD23	1.73	0.52
3:J:514:THR:OG1	3:J:594:GLN:O	2.26	0.52
3:J:646:ILE:HD11	3:J:764:ARG:HD2	1.91	0.52
2:C:1192:GLU:O	2:C:1196:LYS:HG2	2.10	0.52
3:D:646:ILE:HD11	3:D:764:ARG:HD2	1.92	0.52
2:I:519:ASN:HD21	2:I:796:LEU:HD23	1.74	0.52
3:J:527:LEU:HD21	3:J:536:LEU:HG	1.92	0.52
3:D:1372:ARG:HH21	3:J:854:ALA:HB3	1.75	0.52
1:G:14:VAL:HG22	1:G:15:ASP:H	1.74	0.52
3:J:587:LEU:HD11	3:J:608:CYS:HA	1.91	0.52
2:C:801:ARG:HG2	2:C:1094:VAL:HG23	1.92	0.52
5:F:479:THR:HG23	5:F:481:GLU:H	1.74	0.52
2:I:30:ILE:HD11	2:I:575:LEU:HD22	1.91	0.52
3:J:426:ALA:HB3	3:J:427:PRO:HD3	1.91	0.52
3:J:709:ARG:C	3:J:711:GLY:H	2.13	0.52
2:C:90:VAL:HG12	2:C:91:THR:H	1.75	0.52
5:L:166:VAL:O	5:L:167:ASP:HB2	2.10	0.52
2:C:125:GLY:HA2	2:C:499:SER:HB2	1.91	0.52
3:D:709:ARG:C	3:D:711:GLY:H	2.13	0.52
5:F:166:VAL:O	5:F:167:ASP:HB2	2.10	0.52
2:I:594:VAL:HG22	2:I:599:VAL:HA	1.92	0.52
3:J:1266:ILE:HA	3:J:1302:TYR:HA	1.92	0.52
5:L:573:LEU:HD23	5:L:573:LEU:H	1.75	0.52
3:D:426:ALA:HB3	3:D:427:PRO:HD3	1.92	0.52
5:F:246:GLN:HE21	5:F:249:ILE:HD12	1.75	0.52
1:H:29:GLU:HB3	1:H:200:LYS:HG3	1.92	0.52
3:J:843:VAL:HG11	3:J:897:HIS:O	2.10	0.52
2:C:250:THR:HA	2:C:268:ARG:HA	1.92	0.51
2:I:250:THR:HA	2:I:268:ARG:HA	1.92	0.51
1:B:29:GLU:HB3	1:B:200:LYS:HG3	1.92	0.51
1:B:133:LEU:HD11	1:B:140:ILE:HG21	1.92	0.51
1:B:190:ALA:HB2	1:B:200:LYS:HB2	1.92	0.51
2:C:109:ALA:HB1	2:C:111:GLU:HA	1.91	0.51
1:G:41:ASN:ND2	2:I:1216:ARG:O	2.43	0.51
1:H:101:THR:HG22	1:H:116:THR:HB	1.91	0.51
1:H:133:LEU:HD11	1:H:140:ILE:HG21	1.91	0.51
2:I:1106:ARG:H	2:I:1106:ARG:HD2	1.76	0.51
3:J:147:ILE:HG22	3:J:188:LEU:HG	1.91	0.51
5:L:420:GLU:OE1	5:L:423:ARG:NH2	2.32	0.51

Continued on next page...

Continued from previous page...

Atom-1	Atom-2	Interatomic distance (Å)	Clash overlap (Å)
3:D:368:LEU:HD22	3:D:373:ALA:HB2	1.93	0.51
3:D:587:LEU:HD11	3:D:608:CYS:HA	1.92	0.51
5:F:134:VAL:HG22	5:F:273:MET:HE3	1.92	0.51
5:L:148:TYR:HE1	5:L:158:LEU:HD21	1.75	0.51
1:B:37:HIS:CE1	2:C:1216:ARG:HD2	2.45	0.51
3:D:1155:ILE:HD12	3:D:1210:ILE:HB	1.91	0.51
2:I:206:ALA:O	2:I:209:ILE:HG22	2.11	0.51
2:I:801:ARG:HG2	2:I:1094:VAL:HG23	1.90	0.51
2:C:672:GLU:HG2	2:C:1187:PHE:HA	1.92	0.51
2:I:1192:GLU:O	2:I:1196:LYS:HG2	2.11	0.51
2:I:1223:ARG:NH1	3:J:721:SER:OG	2.34	0.51
3:J:1155:ILE:HD12	3:J:1210:ILE:HB	1.91	0.51
2:C:555:TYR:HD2	6:C:1401:42S:H1	1.76	0.51
5:F:486:ARG:HB2	5:F:486:ARG:CZ	2.41	0.51
2:I:555:TYR:HD2	6:I:1401:42S:H1	1.76	0.51
3:D:412:LEU:HA	3:D:415:VAL:HG22	1.92	0.51
5:F:148:TYR:HE1	5:F:158:LEU:HD21	1.75	0.51
5:F:483:LEU:HD12	5:F:483:LEU:H	1.75	0.51
5:L:246:GLN:HE21	5:L:249:ILE:HD12	1.75	0.51
2:I:1157:GLN:O	2:I:1158:LYS:HG2	2.11	0.51
2:C:206:ALA:O	2:C:209:ILE:HG22	2.11	0.50
2:C:1157:GLN:O	2:C:1158:LYS:HG2	2.11	0.50
3:J:978:ARG:HB2	3:J:1199:PHE:CZ	2.45	0.50
5:L:314:THR:O	5:L:318:ALA:HB3	2.12	0.50
3:D:527:LEU:HD21	3:D:536:LEU:HG	1.93	0.50
2:I:4:SER:OG	2:I:5:TYR:N	2.42	0.50
2:I:109:ALA:HB1	2:I:111:GLU:HA	1.93	0.50
2:I:201:ARG:NH2	2:I:370:MET:O	2.38	0.50
2:I:109:ALA:HB1	2:I:110:PRO:C	2.31	0.50
5:L:164:GLY:O	5:L:260:ARG:HB2	2.11	0.50
1:B:6:THR:O	1:B:6:THR:OG1	2.24	0.50
2:C:400:VAL:HG11	2:C:452:ARG:HD2	1.93	0.50
3:D:363:LEU:HD23	3:D:487:THR:HG22	1.93	0.50
1:G:90:VAL:HG23	1:G:123:ILE:HD13	1.94	0.50
3:J:363:LEU:HD23	3:J:487:THR:HG22	1.93	0.50
2:I:13:LYS:NZ	2:I:1148:ALA:O	2.45	0.50
3:J:1184:ASP:O	3:J:1186:TYR:N	2.45	0.50
4:K:39:VAL:HG22	4:K:40:PRO:HD2	1.93	0.50
2:C:618:GLN:HG3	2:C:620:ASN:H	1.77	0.50
3:D:514:THR:OG1	3:D:594:GLN:O	2.27	0.50
2:I:26:TYR:HE2	2:I:32:LEU:HD12	1.76	0.50

Continued on next page...

Continued from previous page...

Atom-1	Atom-2	Interatomic distance (Å)	Clash overlap (Å)
2:I:90:VAL:HG12	2:I:91:THR:H	1.77	0.50
2:I:115:LYS:HE3	2:I:116:ASP:H	1.77	0.50
3:J:872:LEU:HD22	3:J:877:VAL:HG11	1.94	0.50
3:J:973:LEU:HD23	3:J:1003:LEU:HD12	1.94	0.50
2:I:125:GLY:HA2	2:I:499:SER:HB2	1.92	0.50
2:I:618:GLN:HG3	2:I:620:ASN:H	1.76	0.50
5:L:134:VAL:HG22	5:L:273:MET:HE3	1.94	0.50
1:A:172:LEU:HD12	1:A:172:LEU:H	1.76	0.50
1:A:231:PHE:CE1	1:B:221:ALA:HB3	2.47	0.50
2:C:590:PRO:HG3	2:C:605:TYR:CZ	2.47	0.50
2:C:594:VAL:HG22	2:C:599:VAL:HA	1.93	0.50
3:D:843:VAL:HG11	3:D:897:HIS:O	2.11	0.50
5:F:128:ASN:HA	5:F:131:GLN:HE21	1.77	0.50
1:A:45:ARG:HH22	2:C:1216:ARG:HA	1.77	0.50
3:D:152:THR:OG1	3:D:153:ASN:N	2.44	0.50
3:D:1221:LEU:HD11	3:D:1304:ARG:O	2.12	0.50
2:C:642:SER:HB2	3:D:770:LEU:HD21	1.93	0.49
3:D:19:ALA:O	3:D:20:ILE:HG13	2.11	0.49
3:D:268:LEU:HD13	3:D:306:LEU:HA	1.94	0.49
4:E:71:GLU:HA	4:E:74:GLU:HG3	1.94	0.49
2:C:871:VAL:O	2:C:944:ARG:NH1	2.44	0.49
3:D:1266:ILE:HA	3:D:1302:TYR:HA	1.93	0.49
1:H:190:ALA:HB2	1:H:200:LYS:HB2	1.92	0.49
3:J:368:LEU:HD22	3:J:373:ALA:HB2	1.93	0.49
1:A:45:ARG:HG2	1:B:38:THR:HB	1.94	0.49
1:A:90:VAL:HG23	1:A:123:ILE:HD13	1.94	0.49
2:C:870:ILE:HG21	2:C:931:VAL:HG11	1.94	0.49
2:C:1030:GLU:OE1	2:C:1033:ARG:NH2	2.45	0.49
2:I:478:ARG:HH12	2:I:482:GLY:HA2	1.77	0.49
2:I:528:ARG:NH2	2:I:575:LEU:HD23	2.27	0.49
2:I:590:PRO:HG3	2:I:605:TYR:CZ	2.47	0.49
2:C:1108:ASN:OD1	2:C:1111:GLN:NE2	2.45	0.49
5:F:164:GLY:O	5:F:260:ARG:HB2	2.12	0.49
3:J:268:LEU:HD13	3:J:306:LEU:HA	1.94	0.49
3:D:491:LEU:HB2	3:D:904:ALA:HA	1.94	0.49
3:D:706:VAL:HG12	3:D:715:LYS:HB3	1.95	0.49
1:G:172:LEU:HD12	1:G:172:LEU:H	1.77	0.49
1:H:91:ARG:HG3	1:H:122:GLU:HB3	1.94	0.49
1:H:182:ARG:NH1	3:J:534:GLU:OE1	2.45	0.49
3:J:19:ALA:O	3:J:20:ILE:HG13	2.12	0.49
3:D:425:ARG:HD2	3:D:459:ALA:HB2	1.94	0.49

Continued on next page...

Continued from previous page...

Atom-1	Atom-2	Interatomic distance (Å)	Clash overlap (Å)
5:L:486:ARG:HB2	5:L:486:ARG:CZ	2.43	0.49
1:B:91:ARG:HG3	1:B:122:GLU:HB3	1.94	0.49
2:C:65:ASN:HB3	2:C:105:TYR:HB2	1.94	0.49
4:E:38:LEU:HD23	4:E:58:LEU:HD13	1.93	0.49
5:F:314:THR:O	5:F:318:ALA:HB3	2.12	0.49
2:I:1030:GLU:OE1	2:I:1033:ARG:NH2	2.45	0.49
3:J:865:HIS:CE1	3:J:867:GLN:HB2	2.47	0.49
2:C:30:ILE:HD11	2:C:575:LEU:HD22	1.93	0.49
2:C:528:ARG:NH2	2:C:575:LEU:HD23	2.28	0.49
2:I:463:GLN:HG3	2:I:505:PHE:HB2	1.95	0.49
5:F:119:ILE:HA	5:F:122:ARG:HD3	1.95	0.49
2:I:642:SER:HB2	3:J:770:LEU:HD21	1.95	0.49
2:I:829:THR:HA	2:I:1059:ARG:HA	1.95	0.49
3:J:120:LEU:HB3	3:J:121:PRO:HD3	1.95	0.49
3:J:849:LEU:HB3	3:J:853:THR:HG23	1.95	0.49
1:A:102:LEU:HB3	1:A:142:MET:HG2	1.95	0.49
2:I:968:GLU:HG3	2:I:1018:TYR:HE1	1.78	0.49
3:J:1366:HIS:O	3:J:1370:MET:N	2.39	0.49
2:C:201:ARG:NH2	2:C:370:MET:O	2.39	0.48
2:I:1108:ASN:OD1	2:I:1111:GLN:NE2	2.46	0.48
3:J:77:ARG:HB3	3:J:80:HIS:ND1	2.28	0.48
3:J:115:TRP:CE2	3:J:1329:THR:HG23	2.48	0.48
3:D:872:LEU:HD22	3:D:877:VAL:HG11	1.94	0.48
5:F:105:MET:HE1	5:F:385:ARG:HG2	1.95	0.48
2:I:799:ASN:HA	2:I:1231:TYR:HA	1.95	0.48
2:I:896:THR:HB	2:I:897:PRO:HD2	1.95	0.48
2:C:13:LYS:NZ	2:C:1148:ALA:O	2.46	0.48
2:C:50:GLU:HG2	2:C:73:TYR:HE1	1.79	0.48
2:C:115:LYS:HE3	2:C:116:ASP:H	1.77	0.48
2:C:799:ASN:HA	2:C:1231:TYR:HA	1.96	0.48
2:I:870:ILE:HG21	2:I:931:VAL:HG11	1.94	0.48
3:D:356:THR:OG1	3:D:357:VAL:N	2.47	0.48
3:D:865:HIS:CE1	3:D:867:GLN:HB2	2.48	0.48
4:E:15:ASN:HB3	4:E:18:ASP:HB2	1.94	0.48
1:G:66:HIS:HA	1:G:171:LEU:HD11	1.96	0.48
2:I:1065:LYS:HE2	3:J:462:ASP:O	2.14	0.48
3:J:1221:LEU:HD11	3:J:1304:ARG:O	2.13	0.48
2:C:202:ARG:HD3	2:C:369:MET:HG2	1.96	0.48
2:C:478:ARG:HG2	2:C:492:MET:HG2	1.96	0.48
2:C:478:ARG:HH12	2:C:482:GLY:HA2	1.78	0.48
2:C:490:GLN:HG2	2:C:491:ASP:N	2.27	0.48

Continued on next page...

Continued from previous page...

Atom-1	Atom-2	Interatomic distance (Å)	Clash overlap (Å)
3:D:1184:ASP:O	3:D:1186:TYR:N	2.45	0.48
1:H:23:HIS:ND1	1:H:206:GLU:HG2	2.29	0.48
2:I:65:ASN:HB3	2:I:105:TYR:HB2	1.94	0.48
3:D:113:HIS:HD1	3:D:115:TRP:H	1.61	0.48
3:D:1167:LYS:HD3	3:D:1174:ARG:HD2	1.96	0.48
3:J:1233:ILE:O	3:J:1237:VAL:HG12	2.14	0.48
2:C:886:LYS:H	2:C:917:SER:HB3	1.79	0.48
2:C:896:THR:HB	2:C:897:PRO:HD2	1.94	0.48
1:G:102:LEU:HB3	1:G:142:MET:HG2	1.95	0.48
2:I:593:LYS:HE3	2:I:595:THR:HG22	1.96	0.48
2:I:886:LYS:H	2:I:917:SER:HB3	1.79	0.48
3:J:131:PRO:HG2	3:J:134:ASP:HB2	1.96	0.48
3:J:706:VAL:HG12	3:J:715:LYS:HB3	1.95	0.48
5:L:98:VAL:HB	5:L:402:LEU:HD11	1.96	0.48
5:L:119:ILE:HA	5:L:122:ARG:HD3	1.95	0.48
2:C:23:ASP:OD1	2:C:23:ASP:N	2.46	0.48
2:I:478:ARG:HG2	2:I:492:MET:HG2	1.96	0.48
3:J:111:THR:O	3:J:239:LEU:N	2.40	0.48
5:L:483:LEU:HD12	5:L:483:LEU:H	1.79	0.48
1:A:118:ASP:HB3	1:A:121:VAL:HG23	1.96	0.48
1:B:23:HIS:ND1	1:B:206:GLU:HG2	2.29	0.48
3:D:77:ARG:HB3	3:D:80:HIS:ND1	2.28	0.48
3:D:600:ALA:O	3:D:603:LYS:HG2	2.14	0.48
3:J:298:MET:SD	5:L:402:LEU:HB3	2.53	0.48
2:C:463:GLN:HG3	2:C:505:PHE:HB2	1.95	0.48
1:H:134:THR:HG23	1:H:135:ASP:N	2.29	0.48
2:I:42:ASP:OD2	2:I:46:GLN:HB3	2.13	0.48
2:I:50:GLU:HG2	2:I:73:TYR:HE1	1.79	0.48
2:I:582:ASN:HB3	2:I:586:PHE:H	1.78	0.48
5:L:602:SER:OG	5:L:603:ARG:N	2.47	0.48
2:C:724:VAL:HG23	2:C:775:GLU:O	2.14	0.47
2:C:980:VAL:HA	2:C:984:VAL:HA	1.96	0.47
2:C:1072:ASN:OD1	2:C:1072:ASN:N	2.41	0.47
3:D:800:LEU:O	3:D:803:VAL:HG12	2.14	0.47
3:D:810:THR:HG23	3:D:811:GLU:H	1.78	0.47
2:I:1287:LEU:HD13	3:J:1357:ILE:HD11	1.96	0.47
3:J:645:VAL:HB	3:J:701:LEU:HD23	1.96	0.47
3:J:694:SER:OG	3:J:738:ARG:NE	2.47	0.47
3:J:698:MET:O	3:J:702:GLN:HB3	2.14	0.47
3:J:1343:GLU:HB3	3:J:1345:ARG:HD3	1.95	0.47
2:C:1065:LYS:HE2	3:D:462:ASP:O	2.15	0.47

Continued on next page...

Continued from previous page...

Atom-1	Atom-2	Interatomic distance (Å)	Clash overlap (Å)
2:C:1184:THR:HG23	2:C:1189:GLY:HA3	1.96	0.47
3:J:425:ARG:HD2	3:J:459:ALA:HB2	1.95	0.47
1:A:66:HIS:HA	1:A:171:LEU:HD11	1.95	0.47
2:C:692:THR:OG1	2:C:693:LEU:N	2.45	0.47
2:C:829:THR:HA	2:C:1059:ARG:HA	1.95	0.47
3:D:317:THR:HG23	3:D:320:ASN:HB3	1.96	0.47
1:G:83:LEU:HD23	2:I:694:ARG:NH2	2.30	0.47
3:D:97:VAL:HG12	3:D:101:ARG:HG3	1.97	0.47
3:D:694:SER:OG	3:D:738:ARG:NE	2.47	0.47
2:I:1184:THR:HG23	2:I:1189:GLY:HA3	1.97	0.47
3:J:800:LEU:O	3:J:803:VAL:HG12	2.15	0.47
3:J:901:ARG:HD2	3:J:906:GLY:O	2.14	0.47
1:B:205:MET:HE3	1:B:213:PRO:HB3	1.95	0.47
3:D:698:MET:O	3:D:702:GLN:HB3	2.14	0.47
3:D:849:LEU:HB3	3:D:853:THR:HG23	1.97	0.47
3:D:1347:LEU:HG	3:D:1357:ILE:HG23	1.97	0.47
1:H:95:LYS:HZ3	1:H:98:VAL:HG23	1.79	0.47
2:I:149:LEU:HB2	2:I:530:ILE:CG2	2.45	0.47
2:I:316:GLU:H	2:I:316:GLU:CD	2.18	0.47
2:I:496:LYS:HE3	2:I:496:LYS:HB3	1.65	0.47
3:J:113:HIS:HD1	3:J:115:TRP:H	1.63	0.47
3:J:152:THR:OG1	3:J:153:ASN:N	2.44	0.47
3:J:290:ILE:H	3:J:290:ILE:HD12	1.79	0.47
3:J:825:VAL:C	3:J:826:ILE:HG13	2.35	0.47
3:J:1347:LEU:HG	3:J:1357:ILE:HG23	1.97	0.47
5:L:299:LYS:HA	5:L:302:PHE:HB3	1.96	0.47
2:C:316:GLU:CD	2:C:316:GLU:H	2.18	0.47
3:D:298:MET:SD	5:F:402:LEU:HB3	2.54	0.47
3:D:708:ASN:OD1	3:D:708:ASN:N	2.48	0.47
3:J:1167:LYS:HD3	3:J:1174:ARG:HD2	1.96	0.47
2:C:269:ILE:HG23	2:C:273:HIS:HB2	1.97	0.47
2:C:470:ARG:NE	2:C:497:PRO:HB3	2.30	0.47
3:D:526:VAL:HG12	3:D:549:LYS:HB2	1.96	0.47
3:D:825:VAL:C	3:D:826:ILE:HG13	2.35	0.47
3:D:857:LEU:HD12	3:D:858:VAL:H	1.79	0.47
3:D:1293:GLU:OE1	3:D:1294:ALA:N	2.47	0.47
2:I:202:ARG:HD3	2:I:369:MET:HG2	1.97	0.47
2:I:724:VAL:HG23	2:I:775:GLU:O	2.15	0.47
2:I:980:VAL:HA	2:I:984:VAL:HA	1.96	0.47
3:J:1137:GLY:O	3:J:1140:ARG:HB3	2.15	0.47
5:L:244:THR:O	5:L:247:GLU:HG2	2.15	0.47

Continued on next page...

Continued from previous page...

Atom-1	Atom-2	Interatomic distance (Å)	Clash overlap (Å)
1:A:22:THR:HB	1:A:206:GLU:OE2	2.15	0.47
3:D:901:ARG:HD2	3:D:906:GLY:O	2.15	0.47
4:E:50:ALA:O	4:E:54:ILE:HG12	2.15	0.47
1:H:205:MET:HE3	1:H:213:PRO:HB3	1.96	0.47
1:B:134:THR:HG23	1:B:135:ASP:N	2.29	0.47
3:D:1366:HIS:O	3:D:1370:MET:N	2.40	0.47
2:I:344:GLY:HA3	2:I:346:TYR:CZ	2.50	0.47
3:J:526:VAL:HG12	3:J:549:LYS:HB2	1.96	0.47
2:C:593:LYS:HE3	2:C:595:THR:HG22	1.97	0.47
2:C:1247:SER:HB3	3:D:375:GLU:O	2.15	0.47
2:C:1262:LYS:HB2	2:C:1264:GLN:HB3	1.97	0.47
2:C:1271:GLY:HA2	3:D:344:GLY:HA2	1.97	0.47
2:C:1307:ASN:HB3	2:C:1312:ASN:O	2.15	0.47
5:F:602:SER:OG	5:F:603:ARG:N	2.47	0.47
1:G:118:ASP:HB3	1:G:121:VAL:HG23	1.96	0.47
2:I:146:VAL:HG13	2:I:529:ARG:HB3	1.97	0.47
2:I:494:ASN:HD22	2:I:497:PRO:HD3	1.80	0.47
2:I:692:THR:OG1	2:I:693:LEU:N	2.46	0.47
2:I:1307:ASN:HB3	2:I:1312:ASN:O	2.15	0.47
3:J:810:THR:HG23	3:J:811:GLU:H	1.79	0.47
2:C:151:ARG:CZ	2:C:445:ILE:HD11	2.45	0.46
2:C:170:VAL:HG23	2:C:171:LEU:N	2.30	0.46
5:F:98:VAL:HB	5:F:402:LEU:HD11	1.96	0.46
5:F:499:LYS:HB2	5:F:499:LYS:HE3	1.76	0.46
2:I:1161:LEU:HD12	2:I:1161:LEU:HA	1.56	0.46
3:D:807:LEU:HD23	3:D:915:ILE:HG13	1.96	0.46
2:I:170:VAL:HG23	2:I:171:LEU:N	2.30	0.46
2:I:470:ARG:NE	2:I:497:PRO:HB3	2.31	0.46
2:I:1238:LEU:HD12	2:I:1238:LEU:H	1.81	0.46
2:I:1271:GLY:HA2	3:J:344:GLY:HA2	1.97	0.46
5:L:130:VAL:HB	5:L:365:MET:HG3	1.95	0.46
5:L:292:VAL:HG21	5:L:299:LYS:HG2	1.98	0.46
2:C:968:GLU:HG3	2:C:1018:TYR:HE1	1.79	0.46
2:C:1101:LEU:HD23	3:D:725:MET:SD	2.56	0.46
2:C:1287:LEU:HD13	3:D:1357:ILE:HD11	1.96	0.46
3:D:120:LEU:HB3	3:D:121:PRO:HD3	1.96	0.46
3:D:131:PRO:HG2	3:D:134:ASP:HB2	1.97	0.46
3:D:133:ARG:HA	3:D:133:ARG:HD2	1.80	0.46
3:D:645:VAL:HB	3:D:701:LEU:HD23	1.96	0.46
2:I:144:VAL:HG23	2:I:515:MET:HB2	1.96	0.46
2:I:229:ILE:HB	2:I:240:GLU:HB2	1.97	0.46

Continued on next page...

Continued from previous page...

Atom-1	Atom-2	Interatomic distance (Å)	Clash overlap (Å)
3:J:42:GLU:OE1	3:J:42:GLU:N	2.49	0.46
2:C:42:ASP:OD2	2:C:46:GLN:HB3	2.15	0.46
2:C:1246:ARG:NE	3:D:348:ASP:OD1	2.47	0.46
3:D:56:LEU:HD12	3:D:56:LEU:H	1.80	0.46
1:G:184:ALA:HB2	2:I:1091:GLY:HA3	1.97	0.46
2:I:1159:VAL:HB	2:I:1160:ASP:H	1.48	0.46
2:I:1308:ILE:HG21	3:J:379:PRO:HB2	1.98	0.46
5:L:165:PHE:CE2	5:L:217:ALA:HA	2.51	0.46
1:A:195:ARG:HG2	1:A:198:LEU:HG	1.96	0.46
2:C:344:GLY:HA3	2:C:346:TYR:CZ	2.50	0.46
3:D:709:ARG:O	3:D:711:GLY:N	2.45	0.46
3:J:35:PHE:CD1	3:J:101:ARG:HD3	2.51	0.46
3:J:56:LEU:HD12	3:J:56:LEU:H	1.80	0.46
3:J:527:LEU:HD22	3:J:533:ALA:HA	1.97	0.46
3:J:600:ALA:O	3:J:603:LYS:HG2	2.15	0.46
2:C:301:TYR:HB2	2:C:311:CYS:SG	2.55	0.46
2:C:494:ASN:HD22	2:C:497:PRO:HD3	1.80	0.46
3:D:474:LEU:HD23	4:E:28:ARG:HG2	1.97	0.46
3:D:1137:GLY:O	3:D:1140:ARG:HB3	2.16	0.46
3:D:1346:GLY:O	3:D:1350:ASN:ND2	2.49	0.46
1:H:149:GLY:HA3	1:H:177:TYR:CD2	2.50	0.46
2:I:660:VAL:HG13	2:I:661:VAL:HG13	1.97	0.46
5:L:105:MET:HE1	5:L:385:ARG:HG2	1.97	0.46
3:D:647:PRO:HG3	3:D:697:MET:HB3	1.98	0.46
3:D:746:LEU:HD23	3:D:758:PRO:HG3	1.98	0.46
5:F:281:ARG:O	5:F:285:ARG:HG3	2.15	0.46
5:F:299:LYS:HA	5:F:302:PHE:HB3	1.97	0.46
5:F:569:THR:OG1	5:F:570:ASP:N	2.49	0.46
1:G:22:THR:HB	1:G:206:GLU:OE2	2.15	0.46
2:I:1101:LEU:HD23	3:J:725:MET:SD	2.56	0.46
2:I:1246:ARG:NE	3:J:348:ASP:OD1	2.47	0.46
2:I:1247:SER:HB3	3:J:375:GLU:O	2.16	0.46
3:J:436:ALA:HB3	3:J:485:MET:HA	1.97	0.46
3:J:857:LEU:HD12	3:J:858:VAL:H	1.80	0.46
5:L:290:LEU:HB3	5:L:333:VAL:HG21	1.96	0.46
1:B:59:VAL:HG21	1:B:85:LEU:HD13	1.98	0.46
2:C:37:LYS:HD3	2:C:37:LYS:HA	1.78	0.46
3:J:317:THR:HG23	3:J:320:ASN:HB3	1.97	0.46
5:L:569:THR:OG1	5:L:570:ASP:N	2.48	0.46
3:D:77:ARG:HG3	3:D:79:LYS:H	1.81	0.46
3:D:1233:ILE:O	3:D:1237:VAL:HG12	2.15	0.46

Continued on next page...

Continued from previous page...

Atom-1	Atom-2	Interatomic distance (Å)	Clash overlap (Å)
5:F:290:LEU:HB3	5:F:333:VAL:HG21	1.98	0.46
2:I:301:TYR:HB2	2:I:311:CYS:SG	2.56	0.46
2:I:498:ILE:HD12	2:I:498:ILE:H	1.81	0.46
3:J:97:VAL:HG12	3:J:101:ARG:HG3	1.96	0.46
3:J:1293:GLU:OE1	3:J:1294:ALA:N	2.48	0.46
5:L:231:THR:HG23	5:L:249:ILE:HG12	1.98	0.46
2:C:24:VAL:HG21	2:C:704:MET:SD	2.57	0.46
2:C:548:ARG:HB3	2:C:569:ILE:O	2.16	0.46
2:C:660:VAL:HG13	2:C:661:VAL:HG13	1.97	0.46
3:D:839:VAL:HG12	3:D:864:LEU:HD12	1.98	0.46
2:I:548:ARG:HB3	2:I:569:ILE:O	2.15	0.46
3:J:746:LEU:HD23	3:J:758:PRO:HG3	1.98	0.46
3:D:361:LEU:HD22	3:D:365:GLN:HG3	1.98	0.45
5:F:244:THR:O	5:F:247:GLU:HG2	2.16	0.45
5:F:493:LYS:HA	5:F:496:LYS:HE2	1.98	0.45
3:J:647:PRO:HG3	3:J:697:MET:HB3	1.97	0.45
5:L:484:ALA:HB1	5:L:491:GLU:CB	2.46	0.45
1:B:112:ALA:HB2	1:B:128:HIS:HB3	1.99	0.45
2:C:146:VAL:HG13	2:C:529:ARG:HB3	1.98	0.45
3:D:42:GLU:OE1	3:D:42:GLU:N	2.49	0.45
3:D:395:LYS:HG2	5:F:536:THR:HG21	1.97	0.45
3:D:436:ALA:HB3	3:D:485:MET:HA	1.98	0.45
3:D:470:VAL:HA	3:D:471:PRO:HD3	1.76	0.45
3:D:854:ALA:HB2	3:J:1372:ARG:CB	2.44	0.45
3:D:1318:SER:OG	3:D:1342:ASP:OD2	2.25	0.45
5:F:165:PHE:CE2	5:F:217:ALA:HA	2.51	0.45
5:F:532:LEU:HD12	5:F:532:LEU:H	1.82	0.45
3:J:416:ILE:HG12	3:J:441:LEU:HD21	1.99	0.45
3:J:489:ASN:HA	3:J:904:ALA:HB1	1.98	0.45
1:A:13:LEU:HD23	1:A:13:LEU:H	1.81	0.45
2:C:1288:GLN:HG2	2:C:1315:MET:HE1	1.98	0.45
5:F:399:LEU:HD12	5:F:399:LEU:HA	1.79	0.45
1:G:195:ARG:HG2	1:G:198:LEU:HG	1.97	0.45
2:I:136:PHE:CE2	2:I:456:VAL:HG11	2.50	0.45
3:J:950:ILE:HG13	3:J:1020:TRP:HZ3	1.81	0.45
2:C:26:TYR:CZ	2:C:28:LEU:HB2	2.51	0.45
2:C:149:LEU:HB2	2:C:530:ILE:CG2	2.47	0.45
3:D:290:ILE:HD12	3:D:290:ILE:H	1.81	0.45
2:I:26:TYR:CZ	2:I:28:LEU:HB2	2.51	0.45
3:J:317:THR:HB	3:J:324:LEU:HB3	1.98	0.45
1:A:153:VAL:HB	1:A:175:ALA:HB3	1.97	0.45

Continued on next page...

Continued from previous page...

Atom-1	Atom-2	Interatomic distance (Å)	Clash overlap (Å)
1:B:56:VAL:HG22	1:B:144:ILE:HD11	1.99	0.45
2:C:490:GLN:HG3	5:F:472:GLN:OE1	2.17	0.45
3:D:253:VAL:HA	3:D:254:PRO:HD3	1.70	0.45
3:D:527:LEU:HD22	3:D:533:ALA:HA	1.98	0.45
3:D:847:ASP:OD1	3:D:847:ASP:N	2.30	0.45
1:H:35:PHE:HA	1:H:38:THR:HG22	1.99	0.45
3:J:124:ILE:HG23	3:J:189:LEU:HD11	1.97	0.45
4:K:36:ASP:HB2	4:K:37:PRO:HD2	1.99	0.45
3:D:793:SER:O	3:D:797:THR:HG23	2.17	0.45
1:H:107:ILE:HG23	1:H:135:ASP:HA	1.99	0.45
2:I:56:VAL:HG11	2:I:468:LEU:HB3	1.99	0.45
2:I:697:LYS:HE2	2:I:697:LYS:HB3	1.68	0.45
2:I:1256:GLN:HB3	2:I:1301:ARG:HH22	1.80	0.45
3:J:858:VAL:HA	3:J:859:PRO:HD3	1.77	0.45
3:J:984:LEU:HB2	3:J:993:GLU:HB2	1.99	0.45
2:C:245:ARG:HG2	2:C:337:PHE:CZ	2.52	0.45
5:F:561:MET:HG3	5:F:571:TYR:CD2	2.51	0.45
2:I:24:VAL:HG21	2:I:704:MET:SD	2.56	0.45
2:I:1262:LYS:HB2	2:I:1264:GLN:HB3	1.97	0.45
4:K:4:VAL:HG13	4:K:5:THR:HG23	1.98	0.45
5:L:499:LYS:HB2	5:L:499:LYS:HE3	1.77	0.45
5:F:292:VAL:HG21	5:F:299:LYS:HG2	1.98	0.45
2:I:269:ILE:HG23	2:I:273:HIS:HB2	1.98	0.45
3:J:620:PHE:O	3:J:624:ILE:HG13	2.16	0.45
3:J:1238:GLN:NE2	3:J:1248:ILE:O	2.50	0.45
4:K:38:LEU:HD23	4:K:58:LEU:HD13	1.99	0.45
1:A:145:LYS:HB3	1:A:145:LYS:HE3	1.79	0.45
1:B:133:LEU:HD12	1:B:133:LEU:HA	1.88	0.45
1:B:149:GLY:HA3	1:B:177:TYR:CD2	2.51	0.45
1:B:196:THR:HG23	3:D:443:GLU:HG3	1.99	0.45
1:B:218:ARG:O	1:B:222:THR:OG1	2.26	0.45
2:C:3:TYR:HE1	2:C:11:ILE:HD11	1.81	0.45
2:C:582:ASN:HB3	2:C:586:PHE:H	1.82	0.45
2:C:1161:LEU:HD12	2:C:1161:LEU:HA	1.56	0.45
3:D:35:PHE:CD1	3:D:101:ARG:HD3	2.52	0.45
3:D:115:TRP:CE2	3:D:1329:THR:HG23	2.52	0.45
1:H:37:HIS:CE1	2:I:1216:ARG:HD2	2.52	0.45
1:H:56:VAL:HG22	1:H:144:ILE:HD11	1.99	0.45
2:I:3:TYR:HE1	2:I:11:ILE:HD11	1.82	0.45
2:I:14:ASP:N	2:I:1157:GLN:OE1	2.49	0.45
1:A:75:GLN:HA	2:C:729:ALA:N	2.32	0.45

Continued on next page...

Continued from previous page...

Atom-1	Atom-2	Interatomic distance (Å)	Clash overlap (Å)
1:B:151:GLY:O	1:B:177:TYR:HD2	2.00	0.45
2:C:40:GLU:O	2:C:73:TYR:OH	2.34	0.45
2:C:53:PHE:O	2:C:57:PHE:HB2	2.17	0.45
2:C:724:VAL:HA	2:C:734:ILE:HD13	1.99	0.45
2:C:942:ASP:OD2	2:C:1048:LYS:NZ	2.30	0.45
3:D:1238:GLN:NE2	3:D:1248:ILE:O	2.50	0.45
5:F:299:LYS:O	5:F:303:ILE:HG12	2.17	0.45
1:G:153:VAL:HB	1:G:175:ALA:HB3	1.99	0.45
2:I:37:LYS:HA	2:I:37:LYS:HD3	1.78	0.45
2:I:157:PHE:CZ	2:I:431:LYS:HG2	2.52	0.45
2:I:1281:TYR:CD1	3:J:484:MET:HG2	2.52	0.45
3:J:361:LEU:HD22	3:J:365:GLN:HG3	1.98	0.45
2:C:1106:ARG:H	2:C:1106:ARG:HD2	1.81	0.44
2:C:1223:ARG:NH1	3:D:721:SER:OG	2.35	0.44
3:D:1149:ARG:CZ	3:D:1153:PRO:HG2	2.47	0.44
5:F:94:THR:HG23	5:F:96:ASP:OD1	2.17	0.44
1:H:33:ARG:NH1	2:I:1081:PRO:HG3	2.32	0.44
2:I:960:LEU:HB3	2:I:1025:PHE:CE2	2.52	0.44
3:J:733:SER:O	3:J:737:ILE:HG12	2.17	0.44
3:J:827:GLU:C	3:J:829:GLY:H	2.19	0.44
5:L:399:LEU:HD12	5:L:399:LEU:HA	1.79	0.44
5:L:493:LYS:HA	5:L:496:LYS:HE2	1.98	0.44
5:L:561:MET:HG3	5:L:571:TYR:CD2	2.52	0.44
3:D:317:THR:HB	3:D:324:LEU:HB3	1.98	0.44
3:D:665:GLN:HG3	3:D:669:GLN:HE21	1.82	0.44
3:D:1280:VAL:HG21	3:D:1304:ARG:HE	1.82	0.44
5:F:484:ALA:HB1	5:F:491:GLU:CB	2.47	0.44
3:J:959:LYS:HB3	3:J:983:LYS:HB2	1.98	0.44
4:K:50:ALA:O	4:K:54:ILE:HG12	2.16	0.44
5:L:281:ARG:O	5:L:285:ARG:HG3	2.16	0.44
2:C:1160:ASP:HB2	2:C:1163:THR:OG1	2.17	0.44
3:D:124:ILE:HG23	3:D:189:LEU:HD11	1.97	0.44
3:D:418:GLU:O	3:D:420:PRO:HD3	2.17	0.44
2:I:35:PHE:CD2	2:I:130:MET:HB3	2.53	0.44
2:I:1160:ASP:HB2	2:I:1163:THR:OG1	2.18	0.44
2:I:1341:ASP:HB3	2:I:1342:GLU:H	1.52	0.44
3:J:615:LYS:HB2	3:J:616:PRO:HD3	1.99	0.44
5:L:580:PHE:HD1	5:L:580:PHE:HA	1.67	0.44
1:A:221:ALA:HB1	1:B:228:LEU:HD22	1.99	0.44
2:C:157:PHE:CZ	2:C:431:LYS:HG2	2.52	0.44
2:C:498:ILE:HD12	2:C:498:ILE:H	1.82	0.44

Continued on next page...

Continued from previous page...

Atom-1	Atom-2	Interatomic distance (Å)	Clash overlap (Å)
2:C:1238:LEU:HD12	2:C:1238:LEU:H	1.81	0.44
3:D:1292:LEU:HD23	3:J:1226:VAL:HG11	1.98	0.44
5:F:130:VAL:HB	5:F:365:MET:HG3	1.98	0.44
5:F:461:ASN:O	5:F:465:ARG:HG2	2.17	0.44
2:I:53:PHE:O	2:I:57:PHE:HB2	2.17	0.44
2:I:1212:LEU:HD22	2:I:1225:VAL:HG21	1.99	0.44
3:J:248:ASP:O	3:J:251:PRO:HG3	2.18	0.44
3:J:665:GLN:HG3	3:J:669:GLN:HE21	1.82	0.44
3:J:950:ILE:HB	3:J:1018:ALA:HB3	1.99	0.44
1:A:44:ARG:HA	1:A:183:ILE:HG21	2.00	0.44
1:B:107:ILE:HG23	1:B:135:ASP:HA	2.00	0.44
2:C:69:GLN:HG3	2:C:101:ARG:HB3	1.99	0.44
2:C:496:LYS:HE3	2:C:496:LYS:HB3	1.67	0.44
2:C:557:ARG:HH21	2:C:607:SER:C	2.21	0.44
3:D:248:ASP:O	3:D:251:PRO:HG3	2.18	0.44
3:D:279:LEU:HD11	3:D:296:LYS:HG2	2.00	0.44
1:H:41:ASN:O	1:H:45:ARG:HG3	2.17	0.44
2:I:40:GLU:O	2:I:73:TYR:OH	2.35	0.44
5:L:532:LEU:HD12	5:L:532:LEU:H	1.83	0.44
1:B:179:PRO:HA	1:B:208:ASN:ND2	2.32	0.44
1:G:47:LEU:O	1:G:180:VAL:HG21	2.17	0.44
1:H:112:ALA:HB2	1:H:128:HIS:HB3	1.99	0.44
2:I:245:ARG:HG2	2:I:337:PHE:CZ	2.52	0.44
2:I:490:GLN:HG2	2:I:491:ASP:N	2.31	0.44
3:J:708:ASN:OD1	3:J:708:ASN:N	2.50	0.44
3:J:709:ARG:O	3:J:711:GLY:N	2.45	0.44
3:J:1017:VAL:HG23	3:J:1018:ALA:H	1.81	0.44
5:L:461:ASN:O	5:L:465:ARG:HG2	2.18	0.44
3:D:1181:ASP:HA	3:J:202:ARG:HD3	1.99	0.44
1:H:59:VAL:HG21	1:H:85:LEU:HD13	1.99	0.44
2:I:557:ARG:HH21	2:I:607:SER:C	2.21	0.44
2:I:1149:TYR:OH	2:I:1176:LEU:HD11	2.17	0.44
3:J:77:ARG:HG3	3:J:79:LYS:H	1.82	0.44
3:J:839:VAL:HG12	3:J:864:LEU:HD12	1.99	0.44
5:L:492:ASP:HB2	5:L:495:ARG:HH12	1.83	0.44
1:B:41:ASN:O	1:B:45:ARG:HG3	2.18	0.44
2:C:724:VAL:HG11	2:C:727:VAL:HG22	1.99	0.44
2:C:1246:ARG:NH1	2:C:1266:GLY:HA2	2.33	0.44
3:D:416:ILE:HG12	3:D:441:LEU:HD21	1.99	0.44
5:F:231:THR:HG23	5:F:249:ILE:HG12	1.98	0.44
5:F:561:MET:HG2	5:F:576:VAL:HG22	2.00	0.44

Continued on next page...

Continued from previous page...

Atom-1	Atom-2	Interatomic distance (Å)	Clash overlap (Å)
3:J:548:VAL:HG12	3:J:550:VAL:HG13	2.00	0.44
3:J:827:GLU:O	3:J:829:GLY:N	2.37	0.44
5:L:299:LYS:O	5:L:303:ILE:HG12	2.18	0.44
5:F:99:ARG:HD3	5:F:99:ARG:HA	1.81	0.44
5:F:470:MET:HA	5:F:473:GLU:HB3	1.99	0.44
1:G:13:LEU:H	1:G:13:LEU:HD23	1.81	0.44
1:H:151:GLY:O	1:H:177:TYR:HD2	2.01	0.44
1:H:196:THR:HG23	3:J:443:GLU:HG3	1.99	0.44
2:I:1246:ARG:NH1	2:I:1266:GLY:HA2	2.33	0.44
1:B:35:PHE:HA	1:B:38:THR:HG22	1.99	0.43
2:C:14:ASP:N	2:C:1157:GLN:OE1	2.49	0.43
2:C:229:ILE:HB	2:C:240:GLU:HB2	1.98	0.43
2:C:466:VAL:O	2:C:469:VAL:HG22	2.18	0.43
3:D:797:THR:O	3:D:801:VAL:HG13	2.18	0.43
3:D:806:ASP:O	3:D:808:VAL:HG23	2.18	0.43
3:D:1372:ARG:HH21	3:J:854:ALA:CB	2.31	0.43
5:F:281:ARG:HG2	5:F:285:ARG:HD2	2.00	0.43
1:G:207:THR:HG22	1:G:209:GLY:H	1.83	0.43
2:I:1087:TYR:HE1	2:I:1215:GLY:HA2	1.83	0.43
3:J:975:ILE:HD11	3:J:1003:LEU:HD11	2.00	0.43
2:C:26:TYR:CE2	2:C:28:LEU:HB2	2.53	0.43
2:C:117:ILE:HD12	2:C:488:MET:HG2	2.00	0.43
2:C:1314:GLN:HG2	4:E:28:ARG:CZ	2.48	0.43
3:D:103:GLY:HA3	3:D:244:VAL:HG22	2.00	0.43
5:F:492:ASP:HB2	5:F:495:ARG:HH12	1.82	0.43
2:I:26:TYR:CE2	2:I:28:LEU:HB2	2.53	0.43
2:I:591:TYR:HD2	2:I:606:LEU:HD13	1.83	0.43
3:J:294:ASN:HD22	5:L:406:GLN:NE2	2.16	0.43
3:J:418:GLU:O	3:J:420:PRO:HD3	2.17	0.43
3:J:682:VAL:HA	3:J:685:ILE:HD13	2.00	0.43
5:L:470:MET:HA	5:L:473:GLU:HB3	1.99	0.43
2:C:10:ARG:NH1	2:C:697:LYS:HD3	2.34	0.43
2:C:27:LEU:HB2	2:C:524:ILE:HD11	2.00	0.43
3:D:294:ASN:HD22	5:F:406:GLN:NE2	2.17	0.43
3:D:860:ARG:HB3	3:D:861:ASN:H	1.54	0.43
3:D:888:CYS:SG	3:D:890:THR:HB	2.57	0.43
3:D:1227:HIS:HB2	3:J:1293:GLU:HG2	2.01	0.43
2:I:724:VAL:HG11	2:I:727:VAL:HG22	1.99	0.43
3:J:279:LEU:HD11	3:J:296:LYS:HG2	2.00	0.43
2:C:816:ILE:HG22	2:C:818:VAL:HG23	2.00	0.43
3:D:548:VAL:HG12	3:D:550:VAL:HG13	2.00	0.43

Continued on next page...

Continued from previous page...

Atom-1	Atom-2	Interatomic distance (Å)	Clash overlap (Å)
3:D:615:LYS:HB2	3:D:616:PRO:HD3	2.00	0.43
3:D:1360:GLY:HA2	4:E:17:PHE:CE2	2.54	0.43
1:G:44:ARG:HA	1:G:183:ILE:HG21	2.00	0.43
3:J:46:TYR:CD1	5:L:452:ILE:HG22	2.53	0.43
5:L:571:TYR:HD1	5:L:575:GLU:HG2	1.82	0.43
1:A:74:VAL:HG22	1:A:76:GLU:H	1.83	0.43
2:C:56:VAL:HG11	2:C:468:LEU:HB3	1.99	0.43
2:C:179:TYR:OH	2:C:458:GLU:OE2	2.27	0.43
2:C:524:ILE:HG21	2:C:708:VAL:HG13	2.01	0.43
5:F:277:MET:HG3	5:F:362:ASN:ND2	2.33	0.43
1:H:179:PRO:HA	1:H:208:ASN:ND2	2.33	0.43
2:I:10:ARG:NH1	2:I:697:LYS:HD3	2.33	0.43
2:I:524:ILE:HG21	2:I:708:VAL:HG13	2.01	0.43
2:I:1276:TRP:CZ2	3:J:801:VAL:HG21	2.54	0.43
5:L:281:ARG:HG2	5:L:285:ARG:HD2	2.01	0.43
1:A:47:LEU:O	1:A:180:VAL:HG21	2.19	0.43
2:C:83:GLN:O	2:C:87:ILE:HG13	2.19	0.43
2:C:136:PHE:CE2	2:C:456:VAL:HG11	2.53	0.43
2:C:661:VAL:HB	2:C:665:ALA:HB3	2.01	0.43
2:C:1087:TYR:HE1	2:C:1215:GLY:HA2	1.84	0.43
3:D:123:ARG:HD2	3:D:1337:VAL:HG11	2.01	0.43
3:D:620:PHE:O	3:D:624:ILE:HG13	2.18	0.43
3:D:708:ASN:HB3	3:D:712:GLN:O	2.19	0.43
3:D:814:CYS:HB3	3:D:890:THR:OG1	2.18	0.43
2:I:239:MET:O	2:I:284:LEU:HD12	2.19	0.43
5:L:575:GLU:O	5:L:579:GLN:HG2	2.17	0.43
1:A:49:SER:OG	1:A:50:SER:N	2.51	0.43
1:B:67:GLU:O	1:B:78:ILE:HB	2.19	0.43
2:C:144:VAL:HG23	2:C:515:MET:HB2	2.00	0.43
2:C:960:LEU:HB3	2:C:1025:PHE:CE2	2.53	0.43
2:C:1149:TYR:OH	2:C:1176:LEU:HD11	2.18	0.43
3:D:422:LEU:HD13	3:D:471:PRO:HG3	2.00	0.43
3:D:513:MET:HE1	3:D:579:LEU:HD13	2.01	0.43
5:F:245:ALA:O	5:F:249:ILE:HG13	2.17	0.43
1:G:74:VAL:HG22	1:G:76:GLU:H	1.84	0.43
2:I:27:LEU:HB2	2:I:524:ILE:HD11	1.99	0.43
2:I:55:SER:OG	2:I:56:VAL:N	2.52	0.43
2:I:69:GLN:HG3	2:I:101:ARG:HB3	2.00	0.43
2:I:1319:MET:HA	2:I:1320:PRO:HD3	1.94	0.43
3:J:814:CYS:HB3	3:J:890:THR:OG1	2.18	0.43
2:C:838:CYS:SG	2:C:886:LYS:HD3	2.59	0.43

Continued on next page...

Continued from previous page...

Atom-1	Atom-2	Interatomic distance (Å)	Clash overlap (Å)
2:C:1178:LYS:HA	2:C:1178:LYS:HD3	1.85	0.43
3:D:30:ILE:HG23	3:D:243:PRO:HG3	2.00	0.43
3:D:613:GLY:O	3:D:617:THR:OG1	2.29	0.43
3:D:1368:ASP:OD1	3:D:1371:ARG:NH2	2.51	0.43
5:F:476:ARG:HG3	5:F:477:GLU:N	2.33	0.43
2:I:976:ARG:HD2	2:I:989:LEU:HD23	2.00	0.43
2:I:1151:LEU:HD11	2:I:1198:LEU:HD23	2.01	0.43
3:J:94:GLN:O	3:J:97:VAL:HG23	2.18	0.43
3:J:708:ASN:HB3	3:J:712:GLN:O	2.18	0.43
3:J:888:CYS:SG	3:J:890:THR:HB	2.58	0.43
3:J:1280:VAL:HG21	3:J:1304:ARG:HE	1.84	0.43
5:L:280:VAL:HG22	5:L:347:ILE:HD13	2.00	0.43
2:C:1212:LEU:HD22	2:C:1225:VAL:HG21	2.00	0.43
3:D:892:PHE:H	3:D:1281:GLU:HG2	1.84	0.43
2:I:724:VAL:HA	2:I:734:ILE:HD13	1.99	0.43
2:I:1248:THR:HG21	5:L:531:PRO:HG3	2.01	0.43
2:I:1262:LYS:HA	2:I:1262:LYS:HD3	1.78	0.43
3:J:45:ASN:O	3:J:46:TYR:HD2	2.02	0.43
3:J:367:GLY:HA3	3:J:448:GLN:HB2	2.00	0.43
3:J:949:SER:HB3	3:J:1018:ALA:O	2.19	0.43
5:L:245:ALA:O	5:L:249:ILE:HG13	2.18	0.43
5:L:572:THR:O	5:L:576:VAL:HG23	2.18	0.43
3:D:515:ARG:HH21	3:D:717:VAL:HG23	1.84	0.43
3:D:733:SER:O	3:D:737:ILE:HG12	2.18	0.43
2:I:582:ASN:HB3	2:I:586:PHE:N	2.33	0.43
2:I:657:THR:OG1	2:I:1187:PHE:HB2	2.19	0.43
2:I:730:SER:O	2:I:753:LEU:HB2	2.19	0.43
3:J:103:GLY:HA3	3:J:244:VAL:HG22	2.01	0.43
3:J:958:ILE:HD11	3:J:1017:VAL:HG11	2.01	0.43
5:L:296:LYS:HA	5:L:296:LYS:HD3	1.78	0.43
5:L:582:VAL:HG12	5:L:586:ARG:HG2	2.01	0.43
2:C:591:TYR:HD2	2:C:606:LEU:HD13	1.83	0.42
2:C:976:ARG:HD2	2:C:989:LEU:HD23	2.01	0.42
3:D:45:ASN:O	3:D:46:TYR:HD2	2.02	0.42
5:F:280:VAL:HG22	5:F:347:ILE:HD13	2.00	0.42
2:I:811:ASN:C	2:I:815:SER:HB2	2.40	0.42
3:J:30:ILE:HG23	3:J:243:PRO:HG3	2.01	0.42
3:J:35:PHE:HD1	3:J:101:ARG:HB3	1.84	0.42
3:J:1368:ASP:OD1	3:J:1371:ARG:NH2	2.51	0.42
1:B:102:LEU:HA	1:B:102:LEU:HD23	1.82	0.42
2:C:55:SER:OG	2:C:56:VAL:N	2.52	0.42

Continued on next page...

Continued from previous page...

Atom-1	Atom-2	Interatomic distance (Å)	Clash overlap (Å)
2:C:239:MET:O	2:C:284:LEU:HD12	2.19	0.42
2:C:615:VAL:HG13	2:C:651:ASP:H	1.84	0.42
5:F:582:VAL:HG12	5:F:586:ARG:HG2	2.01	0.42
2:I:555:TYR:CD2	6:I:1401:42S:H1	2.55	0.42
2:I:816:ILE:HG22	2:I:818:VAL:HG23	2.00	0.42
3:J:45:ASN:HB3	3:J:48:THR:O	2.19	0.42
3:J:253:VAL:HA	3:J:254:PRO:HD3	1.71	0.42
3:J:422:LEU:HD13	3:J:471:PRO:HG3	1.99	0.42
3:J:599:LYS:HD3	3:J:599:LYS:HA	1.75	0.42
3:J:797:THR:O	3:J:801:VAL:HG13	2.19	0.42
3:J:806:ASP:O	3:J:808:VAL:HG23	2.19	0.42
3:J:892:PHE:H	3:J:1281:GLU:HG2	1.84	0.42
3:J:1259:GLN:NE2	3:J:1262:ARG:HH12	2.17	0.42
2:C:696:ASP:O	2:C:697:LYS:HB3	2.19	0.42
2:C:906:PHE:CE2	5:F:608:ARG:HG3	2.54	0.42
3:J:1174:ARG:HG2	3:J:1189:MET:SD	2.59	0.42
5:L:139:GLU:HG2	5:L:351:THR:HA	2.01	0.42
3:D:362:ARG:H	3:D:365:GLN:NE2	2.18	0.42
3:D:646:ILE:H	3:D:646:ILE:HG12	1.59	0.42
3:D:1172:LYS:HA	3:D:1191:PRO:HA	2.02	0.42
5:F:575:GLU:O	5:F:579:GLN:HG2	2.18	0.42
1:G:49:SER:OG	1:G:50:SER:N	2.53	0.42
1:H:48:LEU:HD21	3:J:535:ARG:HG3	2.01	0.42
2:I:518:ASN:O	2:I:691:PRO:HD3	2.19	0.42
2:I:953:LEU:HD11	2:I:1033:ARG:HG3	2.01	0.42
1:A:231:PHE:HB3	1:B:218:ARG:HH11	1.84	0.42
2:C:35:PHE:CD2	2:C:130:MET:HB3	2.54	0.42
2:C:1151:LEU:HD11	2:C:1198:LEU:HD23	2.02	0.42
3:D:94:GLN:O	3:D:97:VAL:HG23	2.20	0.42
1:G:145:LYS:HE3	1:G:145:LYS:HB3	1.79	0.42
1:H:67:GLU:O	1:H:78:ILE:HB	2.20	0.42
2:I:83:GLN:O	2:I:87:ILE:HG13	2.18	0.42
2:I:615:VAL:HG13	2:I:651:ASP:H	1.83	0.42
3:J:246:PRO:HA	3:J:247:PRO:HD3	1.82	0.42
3:J:1314:LEU:HD11	3:J:1330:ARG:HH22	1.83	0.42
3:J:1346:GLY:O	3:J:1350:ASN:ND2	2.49	0.42
5:L:227:GLN:HG2	5:L:252:LEU:HA	2.02	0.42
1:A:113:ALA:HB2	1:A:126:PRO:HB3	2.01	0.42
1:B:11:PRO:HB3	1:B:30:PRO:O	2.20	0.42
1:B:82:LEU:HD23	1:B:85:LEU:HD12	2.01	0.42
3:D:820:ILE:HG22	3:D:1227:HIS:ND1	2.35	0.42

Continued on next page...

Continued from previous page...

Atom-1	Atom-2	Interatomic distance (Å)	Clash overlap (Å)
3:D:1174:ARG:HG2	3:D:1189:MET:SD	2.59	0.42
3:J:122:SER:O	3:J:126:LEU:HG	2.19	0.42
3:J:807:LEU:HD23	3:J:915:ILE:HG13	2.02	0.42
3:J:1280:VAL:HG11	3:J:1304:ARG:HE	1.84	0.42
5:L:287:ILE:HG12	5:L:337:VAL:HG13	2.02	0.42
5:L:561:MET:HG2	5:L:576:VAL:HG22	2.02	0.42
2:C:120:GLN:HE21	2:C:120:GLN:HB2	1.57	0.42
2:C:700:VAL:HG11	2:C:1114:GLU:HG2	2.01	0.42
2:C:1202:GLY:O	2:C:1203:ASP:HB2	2.18	0.42
3:D:682:VAL:HA	3:D:685:ILE:HD13	2.01	0.42
5:F:571:TYR:HD1	5:F:575:GLU:HG2	1.82	0.42
2:I:696:ASP:O	2:I:697:LYS:HB3	2.20	0.42
2:I:739:ASP:OD1	2:I:739:ASP:N	2.53	0.42
2:I:1100:PRO:O	2:I:1104:PRO:HD3	2.20	0.42
2:I:1202:GLY:O	2:I:1203:ASP:HB2	2.19	0.42
3:J:1172:LYS:HA	3:J:1191:PRO:HA	2.01	0.42
5:L:250:LEU:O	5:L:254:GLU:HG2	2.19	0.42
1:A:99:ILE:HG12	1:A:145:LYS:HG2	2.02	0.42
1:A:207:THR:HG22	1:A:209:GLY:H	1.83	0.42
1:A:228:LEU:HD13	1:A:228:LEU:HA	1.78	0.42
1:B:81:ILE:O	1:B:85:LEU:HG	2.20	0.42
2:C:587:LEU:HD23	2:C:587:LEU:HA	1.87	0.42
2:C:696:ASP:HB3	2:C:697:LYS:H	1.64	0.42
2:C:697:LYS:HB3	2:C:697:LYS:HE2	1.67	0.42
2:C:730:SER:O	2:C:753:LEU:HB2	2.19	0.42
2:C:811:ASN:C	2:C:815:SER:HB2	2.40	0.42
2:C:953:LEU:HD11	2:C:1033:ARG:HG3	2.01	0.42
2:C:1100:PRO:O	2:C:1104:PRO:HD3	2.19	0.42
2:C:1276:TRP:CZ2	3:D:801:VAL:HG21	2.54	0.42
3:D:438:GLU:HA	3:D:439:PRO:HD3	1.93	0.42
5:F:227:GLN:HG2	5:F:252:LEU:HA	2.02	0.42
2:I:117:ILE:HD12	2:I:488:MET:HG2	2.01	0.42
2:I:183:TRP:HB2	2:I:199:ASP:HA	2.02	0.42
2:I:629:PHE:CE2	2:I:650:VAL:HG21	2.54	0.42
2:I:661:VAL:HB	2:I:665:ALA:HB3	2.01	0.42
2:I:1007:LYS:O	2:I:1011:LEU:HG	2.18	0.42
2:I:1116:HIS:CE1	3:J:641:ILE:HB	2.55	0.42
3:J:268:LEU:HB3	3:J:306:LEU:HD23	2.01	0.42
3:J:515:ARG:HH21	3:J:717:VAL:HG23	1.85	0.42
3:J:976:THR:HA	3:J:999:TYR:HE1	1.84	0.42
2:C:1281:TYR:CD1	3:D:484:MET:HG2	2.55	0.42

Continued on next page...

Continued from previous page...

Atom-1	Atom-2	Interatomic distance (Å)	Clash overlap (Å)
3:D:347:VAL:HG12	3:D:348:ASP:O	2.20	0.42
3:D:1295:ASN:HA	3:J:1206:ARG:NH2	2.35	0.42
1:G:39:LEU:HD23	1:G:39:LEU:HA	1.89	0.42
1:H:82:LEU:HD23	1:H:85:LEU:HD12	2.01	0.42
2:I:23:ASP:OD1	2:I:23:ASP:N	2.48	0.42
2:I:169:LYS:O	2:I:169:LYS:HG2	2.19	0.42
3:J:198:CYS:HA	3:J:221:ILE:HD13	2.02	0.42
2:C:518:ASN:O	2:C:691:PRO:HD3	2.20	0.42
2:C:1007:LYS:O	2:C:1011:LEU:HG	2.19	0.42
3:D:198:CYS:HA	3:D:221:ILE:HD13	2.02	0.42
5:F:139:GLU:HG2	5:F:351:THR:HA	2.01	0.42
5:F:528:LEU:HD23	5:F:528:LEU:HA	1.93	0.42
2:I:356:THR:HG21	2:I:362:ALA:HA	2.02	0.42
2:I:700:VAL:HG11	2:I:1114:GLU:HG2	2.01	0.42
3:J:156:ARG:NH2	3:J:191:SER:OG	2.52	0.42
2:C:27:LEU:O	2:C:528:ARG:NH1	2.45	0.41
2:C:178:PRO:HB3	2:C:395:TYR:CZ	2.55	0.41
2:C:629:PHE:CE2	2:C:650:VAL:HG21	2.55	0.41
2:C:1282:GLY:HA3	4:E:17:PHE:CE1	2.55	0.41
2:C:1320:PRO:HG2	3:D:1354:GLY:HA3	2.02	0.41
2:I:906:PHE:CE2	5:L:608:ARG:HG3	2.55	0.41
3:J:384:LYS:HD2	3:J:387:LEU:HD23	2.02	0.41
3:J:820:ILE:HG22	3:J:1227:HIS:ND1	2.35	0.41
3:J:1241:TYR:HD2	3:J:1246:VAL:HG11	1.85	0.41
5:L:528:LEU:HD23	5:L:528:LEU:HA	1.96	0.41
1:A:39:LEU:HD23	1:A:39:LEU:HA	1.89	0.41
1:A:61:ILE:HG23	1:A:142:MET:HB3	2.01	0.41
2:C:657:THR:OG1	2:C:1187:PHE:HB2	2.20	0.41
2:C:1159:VAL:HB	2:C:1160:ASP:H	1.48	0.41
1:G:99:ILE:HG12	1:G:145:LYS:HG2	2.01	0.41
1:G:113:ALA:HB2	1:G:126:PRO:HB3	2.01	0.41
1:H:51:MET:HB3	1:H:178:SER:HA	2.02	0.41
5:L:598:LEU:O	5:L:604:SER:OG	2.36	0.41
2:C:102:LEU:HB2	2:C:489:PRO:HG3	2.02	0.41
2:C:138:ILE:HG22	2:C:139:ASN:N	2.34	0.41
2:C:555:TYR:CD2	6:C:1401:42S:H1	2.54	0.41
2:C:1262:LYS:HA	2:C:1262:LYS:HD3	1.77	0.41
3:D:214:ARG:HA	3:D:217:LEU:HB2	2.02	0.41
1:H:81:ILE:O	1:H:85:LEU:HG	2.20	0.41
2:I:102:LEU:HB2	2:I:489:PRO:HG3	2.02	0.41
3:J:709:ARG:HA	3:J:709:ARG:HD2	1.92	0.41

Continued on next page...

Continued from previous page...

Atom-1	Atom-2	Interatomic distance (Å)	Clash overlap (Å)
3:J:976:THR:HA	3:J:999:TYR:CE1	2.55	0.41
5:L:559:LEU:HD12	5:L:559:LEU:HA	1.83	0.41
1:B:178:SER:HA	1:B:179:PRO:HD3	1.90	0.41
2:C:538:LEU:H	2:C:538:LEU:HG	1.69	0.41
2:C:867:GLU:H	2:C:867:GLU:HG3	1.62	0.41
5:F:457:ILE:HA	5:F:460:ILE:HD12	2.01	0.41
2:I:13:LYS:NZ	2:I:1151:LEU:HB2	2.36	0.41
2:I:587:LEU:HD23	2:I:587:LEU:HA	1.89	0.41
2:I:840:SER:HB2	2:I:850:ILE:HD11	2.03	0.41
2:I:867:GLU:H	2:I:867:GLU:HG3	1.61	0.41
5:L:96:ASP:O	5:L:98:VAL:N	2.53	0.41
5:L:601:PRO:HB3	5:L:604:SER:HB2	2.02	0.41
1:A:42:ALA:O	1:A:46:ILE:HG12	2.21	0.41
1:A:115:ILE:HG22	1:A:116:THR:H	1.86	0.41
2:C:734:ILE:HD12	2:C:777:VAL:HG21	2.03	0.41
3:D:268:LEU:HB3	3:D:306:LEU:HD23	2.01	0.41
3:D:741:ALA:O	3:D:762:ASN:ND2	2.54	0.41
3:D:1205:GLU:O	3:D:1208:ASP:HB2	2.21	0.41
4:E:8:ASP:O	4:E:11:GLU:HB2	2.21	0.41
1:G:228:LEU:HD13	1:G:228:LEU:HA	1.80	0.41
1:H:102:LEU:HA	1:H:102:LEU:HD23	1.82	0.41
2:I:734:ILE:HD12	2:I:777:VAL:HG21	2.01	0.41
3:J:701:LEU:HD13	3:J:723:TYR:HB2	2.03	0.41
1:B:134:THR:HG23	1:B:135:ASP:H	1.86	0.41
2:C:589:THR:HA	2:C:590:PRO:HD3	1.93	0.41
2:C:850:ILE:HG13	2:C:1048:LYS:HE2	2.03	0.41
3:D:384:LYS:HD2	3:D:387:LEU:HD23	2.02	0.41
3:D:832:LYS:HD3	3:D:1242:ARG:NH1	2.35	0.41
3:D:905:ARG:HH11	4:E:16:ARG:HD2	1.85	0.41
5:F:134:VAL:HG21	5:F:266:PHE:CE1	2.45	0.41
5:F:533:ASP:O	5:F:536:THR:N	2.53	0.41
5:F:580:PHE:C	5:F:582:VAL:H	2.23	0.41
1:G:77:ASP:O	1:G:81:ILE:HG13	2.20	0.41
2:I:466:VAL:O	2:I:469:VAL:HG22	2.21	0.41
2:I:838:CYS:SG	2:I:886:LYS:HD3	2.61	0.41
3:J:557:LYS:HE3	3:J:557:LYS:HB2	1.79	0.41
3:J:1205:GLU:O	3:J:1208:ASP:HB2	2.21	0.41
3:J:1267:VAL:HB	3:J:1301:THR:OG1	2.21	0.41
5:L:457:ILE:HA	5:L:460:ILE:HD12	2.02	0.41
5:L:580:PHE:C	5:L:582:VAL:H	2.22	0.41
2:C:237:LEU:HD13	2:C:237:LEU:HA	1.82	0.41

Continued on next page...

Continued from previous page...

Atom-1	Atom-2	Interatomic distance (Å)	Clash overlap (Å)
2:C:801:ARG:HD3	2:C:1094:VAL:HA	2.03	0.41
3:D:246:PRO:HA	3:D:247:PRO:HD3	1.82	0.41
3:D:461:PHE:HD2	3:D:461:PHE:HA	1.75	0.41
3:D:885:VAL:HG12	3:D:894:VAL:HG11	2.03	0.41
5:F:312:SER:OG	5:F:313:ASP:N	2.54	0.41
2:I:17:LYS:HE3	2:I:1154:ASP:HB3	2.01	0.41
2:I:81:ASP:O	2:I:85:CYS:HB2	2.20	0.41
2:I:178:PRO:HB3	2:I:395:TYR:CZ	2.55	0.41
2:I:503:LYS:HD2	2:I:503:LYS:HA	1.89	0.41
3:J:356:THR:OG1	3:J:357:VAL:N	2.48	0.41
2:C:17:LYS:HE3	2:C:1154:ASP:HB3	2.01	0.41
2:C:42:ASP:HA	2:C:43:PRO:HD3	1.87	0.41
2:C:60:GLN:H	2:C:60:GLN:HG2	1.74	0.41
2:C:143:ARG:NH2	2:C:507:GLY:O	2.53	0.41
2:C:582:ASN:HB3	2:C:586:PHE:N	2.34	0.41
2:C:1308:ILE:HG23	3:D:380:PHE:CE2	2.56	0.41
3:D:35:PHE:HD1	3:D:101:ARG:HB3	1.85	0.41
3:D:62:PHE:O	3:D:101:ARG:HD2	2.21	0.41
3:D:839:VAL:HG13	3:D:882:VAL:HG21	2.02	0.41
3:D:931:THR:OG1	3:D:1244:GLN:NE2	2.54	0.41
1:H:147:GLN:HG3	1:H:148:ARG:H	1.86	0.41
2:I:151:ARG:CZ	2:I:445:ILE:HD11	2.51	0.41
2:I:299:LYS:HB3	2:I:299:LYS:HE2	1.95	0.41
2:I:974:ARG:HB3	2:I:1014:LEU:HD21	2.03	0.41
2:I:1179:GLY:O	2:I:1181:PRO:HD3	2.21	0.41
3:J:396:ALA:O	3:J:400:MET:HG3	2.21	0.41
5:L:99:ARG:HA	5:L:99:ARG:HD3	1.70	0.41
5:L:517:SER:O	5:L:518:HIS:HD2	2.04	0.41
2:C:169:LYS:O	2:C:169:LYS:HG2	2.20	0.41
2:C:208:ILE:HD11	2:C:365:GLU:HB3	2.03	0.41
3:D:45:ASN:HB3	3:D:48:THR:O	2.21	0.41
3:D:343:LEU:HD12	3:D:343:LEU:HA	1.81	0.41
3:D:527:LEU:HB2	3:D:550:VAL:HG12	2.02	0.41
3:D:701:LEU:HD13	3:D:723:TYR:HB2	2.03	0.41
3:D:709:ARG:HA	3:D:709:ARG:HD2	1.92	0.41
3:D:850:LYS:HB3	3:D:851:PRO:HD2	2.02	0.41
3:D:1216:ALA:HA	3:D:1217:PRO:HD3	1.87	0.41
3:D:1259:GLN:NE2	3:D:1262:ARG:HH12	2.18	0.41
3:D:1372:ARG:HE	3:J:854:ALA:HB2	1.85	0.41
5:F:96:ASP:O	5:F:98:VAL:N	2.54	0.41
5:F:161:LEU:HD12	5:F:161:LEU:HA	1.92	0.41

Continued on next page...

Continued from previous page...

Atom-1	Atom-2	Interatomic distance (Å)	Clash overlap (Å)
5:F:234:THR:O	5:F:245:ALA:HB2	2.21	0.41
5:F:250:LEU:O	5:F:254:GLU:HG2	2.21	0.41
5:F:296:LYS:HA	5:F:296:LYS:HD3	1.78	0.41
5:F:343:LYS:O	5:F:347:ILE:HG13	2.21	0.41
5:F:601:PRO:HB3	5:F:604:SER:HB2	2.03	0.41
1:G:42:ALA:O	1:G:46:ILE:HG12	2.20	0.41
1:G:61:ILE:HG22	1:G:62:ASP:H	1.85	0.41
1:H:19:VAL:HB	1:H:23:HIS:HD2	1.85	0.41
1:H:61:ILE:HB	1:H:64:VAL:O	2.21	0.41
2:I:850:ILE:HG13	2:I:1048:LYS:HE2	2.03	0.41
3:J:294:ASN:HD22	5:L:406:GLN:HE21	1.69	0.41
3:J:513:MET:HE1	3:J:579:LEU:HD13	2.03	0.41
3:J:793:SER:O	3:J:797:THR:HG23	2.21	0.41
3:J:839:VAL:HG13	3:J:882:VAL:HG21	2.01	0.41
3:J:850:LYS:HB3	3:J:851:PRO:HD2	2.02	0.41
5:L:476:ARG:HG3	5:L:477:GLU:N	2.34	0.41
1:A:228:LEU:HD21	1:B:224:LEU:HD23	2.03	0.41
2:C:13:LYS:NZ	2:C:1151:LEU:HB2	2.36	0.41
2:C:137:VAL:HA	2:C:141:THR:O	2.21	0.41
2:C:183:TRP:HB2	2:C:199:ASP:HA	2.02	0.41
2:C:1124:ILE:HB	2:C:1180:MET:HB2	2.03	0.41
2:C:1142:ARG:HH22	2:C:1165:SER:HB2	1.86	0.41
3:D:122:SER:O	3:D:126:LEU:HG	2.20	0.41
3:D:325:LYS:HG3	3:D:329:ASP:HB2	2.03	0.41
2:I:208:ILE:HD11	2:I:365:GLU:HB3	2.03	0.41
2:I:805:MET:HB2	2:I:805:MET:HE2	1.92	0.41
3:J:214:ARG:HA	3:J:217:LEU:HB2	2.03	0.41
3:J:325:LYS:HG3	3:J:329:ASP:HB2	2.03	0.41
3:J:664:ILE:HG22	3:J:678:ARG:HG2	2.03	0.41
5:L:387:VAL:HG22	5:L:435:ILE:HD13	2.03	0.41
1:A:90:VAL:HG22	1:A:91:ARG:H	1.86	0.40
3:D:451:PRO:O	3:D:454:CYS:HB2	2.21	0.40
3:D:497:GLU:HA	3:D:498:PRO:HD3	1.89	0.40
1:G:61:ILE:HG23	1:G:142:MET:HB3	2.02	0.40
2:I:127:ILE:HA	2:I:128:PRO:HD3	1.92	0.40
3:J:347:VAL:HG12	3:J:348:ASP:O	2.22	0.40
3:J:491:LEU:HD22	3:J:496:GLY:O	2.21	0.40
3:J:832:LYS:HD3	3:J:1242:ARG:NH1	2.36	0.40
5:L:312:SER:OG	5:L:313:ASP:N	2.54	0.40
1:A:31:LEU:CD1	1:A:201:LEU:HB2	2.50	0.40
1:B:61:ILE:HB	1:B:64:VAL:O	2.21	0.40

Continued on next page...

Continued from previous page...

Atom-1	Atom-2	Interatomic distance (Å)	Clash overlap (Å)
2:C:299:LYS:HB3	2:C:299:LYS:HE2	1.96	0.40
2:C:791:LEU:HD23	2:C:791:LEU:HA	1.90	0.40
3:D:57:PHE:HB3	3:D:98:ARG:HH22	1.86	0.40
3:D:233:LYS:HA	3:D:234:PRO:HD3	1.94	0.40
3:D:474:LEU:HA	3:D:477:GLN:HG3	2.03	0.40
4:E:15:ASN:O	4:E:16:ARG:HB3	2.20	0.40
5:F:567:MET:HE3	5:F:571:TYR:HE2	1.87	0.40
1:H:195:ARG:HB3	1:H:198:LEU:HD21	2.03	0.40
2:I:1103:VAL:HG11	2:I:1112:ILE:HD11	2.02	0.40
3:J:527:LEU:HB2	3:J:550:VAL:HG12	2.02	0.40
3:J:833:GLU:HA	3:J:834:PRO:HD3	1.85	0.40
3:J:931:THR:OG1	3:J:1244:GLN:NE2	2.54	0.40
5:L:604:SER:O	5:L:608:ARG:HB2	2.21	0.40
2:C:860:ALA:O	2:C:863:SER:OG	2.34	0.40
2:C:1101:LEU:HD12	3:D:505:ASP:OD2	2.22	0.40
3:D:1198:VAL:HB	3:D:1210:ILE:HA	2.04	0.40
1:G:212:ASP:HA	1:G:213:PRO:HD3	1.97	0.40
1:H:134:THR:HG23	1:H:135:ASP:H	1.86	0.40
2:I:175:ARG:HD3	2:I:183:TRP:CZ3	2.56	0.40
2:I:1092:THR:HA	2:I:1093:PRO:HD3	1.96	0.40
2:I:1164:PHE:O	2:I:1169:VAL:HG23	2.21	0.40
3:J:362:ARG:H	3:J:365:GLN:NE2	2.18	0.40
3:J:972:LYS:HB3	3:J:1002:VAL:HG13	2.03	0.40
4:K:10:VAL:HG13	4:K:16:ARG:HB2	2.02	0.40
5:L:277:MET:HG3	5:L:362:ASN:ND2	2.33	0.40
2:C:175:ARG:HD3	2:C:183:TRP:CZ3	2.57	0.40
3:D:683:ILE:HD11	3:D:754:ILE:HG12	2.03	0.40
5:F:572:THR:O	5:F:576:VAL:HG23	2.20	0.40
2:I:11:ILE:HD13	2:I:11:ILE:HA	1.93	0.40
2:I:409:LEU:HD23	2:I:409:LEU:HA	1.93	0.40
3:J:57:PHE:HB3	3:J:98:ARG:HH22	1.86	0.40
1:B:147:GLN:HG3	1:B:148:ARG:H	1.86	0.40
2:C:59:ILE:HD13	2:C:472:GLU:HA	2.04	0.40
2:C:559:CYS:HA	2:C:560:PRO:HD3	1.92	0.40
2:C:739:ASP:OD1	2:C:739:ASP:N	2.52	0.40
2:C:840:SER:HB2	2:C:850:ILE:HD11	2.02	0.40
3:D:367:GLY:HA3	3:D:448:GLN:HB2	2.03	0.40
3:D:378:LYS:NZ	3:D:382:TYR:OH	2.41	0.40
3:D:557:LYS:HE3	3:D:557:LYS:HB2	1.79	0.40
3:D:573:THR:OG1	3:D:576:ARG:HG3	2.21	0.40
3:D:609:TYR:HB2	3:D:617:THR:HG21	2.04	0.40

Continued on next page...

Continued from previous page...

Atom-1	Atom-2	Interatomic distance (Å)	Clash overlap (Å)
5:F:287:ILE:HG12	5:F:337:VAL:HG13	2.02	0.40
1:H:73:GLY:O	1:H:134:THR:N	2.42	0.40
2:I:972:PHE:HB2	2:I:994:ARG:HH21	1.87	0.40
3:J:22:ILE:O	3:J:1339:GLY:HA2	2.21	0.40
3:J:110:PRO:HD2	3:J:183:GLU:HG2	2.04	0.40
3:J:741:ALA:O	3:J:762:ASN:ND2	2.54	0.40
5:L:315:TRP:CZ2	5:L:341:LEU:HD21	2.55	0.40
5:L:397:ARG:HG2	5:L:443:ILE:HG21	2.03	0.40
5:L:551:LEU:HD21	5:L:598:LEU:HD21	2.02	0.40

There are no symmetry-related clashes.

5.3 Torsion angles [i](#)

5.3.1 Protein backbone [i](#)

In the following table, the Percentiles column shows the percent Ramachandran outliers of the chain as a percentile score with respect to all X-ray entries followed by that with respect to entries of similar resolution.

The Analysed column shows the number of residues for which the backbone conformation was analysed, and the total number of residues.

Mol	Chain	Analysed	Favoured	Allowed	Outliers	Percentiles	
1	A	222/239 (93%)	191 (86%)	28 (13%)	3 (1%)	11	45
1	B	216/239 (90%)	193 (89%)	23 (11%)	0	100	100
1	G	226/239 (95%)	196 (87%)	27 (12%)	3 (1%)	12	47
1	H	213/239 (89%)	193 (91%)	20 (9%)	0	100	100
2	C	1338/1342 (100%)	1231 (92%)	102 (8%)	5 (0%)	34	69
2	I	1338/1342 (100%)	1230 (92%)	103 (8%)	5 (0%)	34	69
3	D	1162/1407 (83%)	1075 (92%)	83 (7%)	4 (0%)	41	74
3	J	1230/1407 (87%)	1141 (93%)	84 (7%)	5 (0%)	34	69
4	E	87/91 (96%)	80 (92%)	7 (8%)	0	100	100
4	K	77/91 (85%)	73 (95%)	4 (5%)	0	100	100
5	F	464/522 (89%)	423 (91%)	40 (9%)	1 (0%)	47	78
5	L	463/522 (89%)	420 (91%)	42 (9%)	1 (0%)	47	78
All	All	7036/7680 (92%)	6446 (92%)	563 (8%)	27 (0%)	34	69

All (27) Ramachandran outliers are listed below:

Mol	Chain	Res	Type
2	C	1159	VAL
2	I	1159	VAL
2	C	170	VAL
2	I	170	VAL
3	J	340	GLN
2	C	697	LYS
2	I	697	LYS
1	A	14	VAL
1	A	62	ASP
1	A	167	PRO
3	D	710	ASP
1	G	14	VAL
1	G	62	ASP
1	G	167	PRO
2	I	484	LEU
3	J	710	ASP
2	C	484	LEU
3	D	831	VAL
3	J	831	VAL
5	L	477	GLU
5	F	477	GLU
2	C	1186	VAL
2	I	1186	VAL
3	D	826	ILE
3	D	1180	VAL
3	J	826	ILE
3	J	1180	VAL

5.3.2 Protein sidechains [i](#)

In the following table, the Percentiles column shows the percent sidechain outliers of the chain as a percentile score with respect to all X-ray entries followed by that with respect to entries of similar resolution.

The Analysed column shows the number of residues for which the sidechain conformation was analysed, and the total number of residues.

Mol	Chain	Analysed	Rotameric	Outliers	Percentiles
1	A	191/206 (93%)	179 (94%)	12 (6%)	18 49
1	B	184/206 (89%)	165 (90%)	19 (10%)	7 31
1	G	191/206 (93%)	179 (94%)	12 (6%)	18 49

Continued on next page...

Continued from previous page...

Mol	Chain	Analysed	Rotameric	Outliers	Percentiles	
1	H	183/206 (89%)	167 (91%)	16 (9%)	10	38
2	C	1155/1157 (100%)	1051 (91%)	104 (9%)	9	37
2	I	1154/1157 (100%)	1050 (91%)	104 (9%)	9	37
3	D	975/1168 (84%)	879 (90%)	96 (10%)	8	33
3	J	1036/1168 (89%)	933 (90%)	103 (10%)	8	32
4	E	72/75 (96%)	64 (89%)	8 (11%)	6	28
4	K	67/75 (89%)	63 (94%)	4 (6%)	19	50
5	F	417/462 (90%)	374 (90%)	43 (10%)	7	31
5	L	418/462 (90%)	373 (89%)	45 (11%)	6	29
All	All	6043/6548 (92%)	5477 (91%)	566 (9%)	8	35

All (566) residues with a non-rotameric sidechain are listed below:

Mol	Chain	Res	Type
1	A	9	LEU
1	A	13	LEU
1	A	50	SER
1	A	61	ILE
1	A	74	VAL
1	A	115	ILE
1	A	133	LEU
1	A	145	LYS
1	A	165	GLU
1	A	215	GLU
1	A	219	ARG
1	A	231	PHE
1	B	6	THR
1	B	7	GLU
1	B	8	PHE
1	B	18	GLN
1	B	29	GLU
1	B	58	GLU
1	B	60	GLU
1	B	65	LEU
1	B	75	GLN
1	B	79	LEU
1	B	80	GLU
1	B	97	GLU
1	B	107	ILE

Continued on next page...

Continued from previous page...

Mol	Chain	Res	Type
1	B	110	VAL
1	B	124	VAL
1	B	134	THR
1	B	160	HIS
1	B	183	ILE
1	B	193	GLU
2	C	4	SER
2	C	11	ILE
2	C	22	LEU
2	C	39	ILE
2	C	60	GLN
2	C	70	TYR
2	C	82	VAL
2	C	85	CYS
2	C	90	VAL
2	C	91	THR
2	C	115	LYS
2	C	116	ASP
2	C	117	ILE
2	C	118	LYS
2	C	119	GLU
2	C	120	GLN
2	C	121	GLU
2	C	132	ASP
2	C	167	SER
2	C	189	ASP
2	C	285	ILE
2	C	299	LYS
2	C	306	THR
2	C	320	ASP
2	C	360	LEU
2	C	369	MET
2	C	377	THR
2	C	394	ARG
2	C	419	ILE
2	C	423	ASP
2	C	434	ASP
2	C	445	ILE
2	C	484	LEU
2	C	485	ASP
2	C	486	THR
2	C	490	GLN

Continued on next page...

Continued from previous page...

Mol	Chain	Res	Type
2	C	493	ILE
2	C	496	LYS
2	C	538	LEU
2	C	539	THR
2	C	542	ARG
2	C	554	HIS
2	C	589	THR
2	C	604	HIS
2	C	607	SER
2	C	609	ILE
2	C	615	VAL
2	C	620	ASN
2	C	623	LEU
2	C	633	LEU
2	C	639	LYS
2	C	657	THR
2	C	672	GLU
2	C	680	LEU
2	C	692	THR
2	C	697	LYS
2	C	705	GLU
2	C	714	VAL
2	C	748	ILE
2	C	773	LEU
2	C	781	ASP
2	C	788	SER
2	C	799	ASN
2	C	800	MET
2	C	814	ASP
2	C	819	SER
2	C	826	ASP
2	C	840	SER
2	C	859	GLU
2	C	878	THR
2	C	890	LYS
2	C	892	GLU
2	C	895	LEU
2	C	944	ARG
2	C	946	LEU
2	C	951	MET
2	C	974	ARG
2	C	984	VAL

Continued on next page...

Continued from previous page...

Mol	Chain	Res	Type
2	C	992	LEU
2	C	1002	LEU
2	C	1006	GLU
2	C	1073	LYS
2	C	1082	ILE
2	C	1083	GLU
2	C	1108	ASN
2	C	1109	ILE
2	C	1114	GLU
2	C	1134	GLN
2	C	1136	GLN
2	C	1146	GLN
2	C	1151	LEU
2	C	1156	ARG
2	C	1159	VAL
2	C	1198	LEU
2	C	1210	ILE
2	C	1237	HIS
2	C	1238	LEU
2	C	1264	GLN
2	C	1265	PHE
2	C	1310	ASP
2	C	1327	LEU
2	C	1331	ARG
2	C	1341	ASP
2	C	1342	GLU
3	D	11	GLN
3	D	18	ASP
3	D	26	SER
3	D	29	MET
3	D	46	TYR
3	D	54	ASP
3	D	79	LYS
3	D	84	ILE
3	D	94	GLN
3	D	95	THR
3	D	159	ILE
3	D	169	LEU
3	D	172	PHE
3	D	175	GLU
3	D	217	LEU
3	D	252	LEU

Continued on next page...

Continued from previous page...

Mol	Chain	Res	Type
3	D	312	ARG
3	D	324	LEU
3	D	330	MET
3	D	334	LYS
3	D	352	ARG
3	D	363	LEU
3	D	374	LEU
3	D	394	ILE
3	D	425	ARG
3	D	454	CYS
3	D	490	ILE
3	D	506	VAL
3	D	513	MET
3	D	514	THR
3	D	523	GLU
3	D	536	LEU
3	D	545	HIS
3	D	547	ARG
3	D	567	THR
3	D	568	SER
3	D	641	ILE
3	D	646	ILE
3	D	660	GLU
3	D	661	VAL
3	D	678	ARG
3	D	680	ASN
3	D	683	ILE
3	D	685	ILE
3	D	697	MET
3	D	698	MET
3	D	701	LEU
3	D	702	GLN
3	D	704	GLU
3	D	707	ILE
3	D	708	ASN
3	D	710	ASP
3	D	712	GLN
3	D	717	VAL
3	D	720	ASN
3	D	740	LEU
3	D	746	LEU
3	D	754	ILE

Continued on next page...

Continued from previous page...

Mol	Chain	Res	Type
3	D	770	LEU
3	D	788	LEU
3	D	798	ARG
3	D	805	GLN
3	D	810	THR
3	D	844	THR
3	D	847	ASP
3	D	848	VAL
3	D	849	LEU
3	D	853	THR
3	D	857	LEU
3	D	858	VAL
3	D	860	ARG
3	D	881	LYS
3	D	897	HIS
3	D	908	ILE
3	D	918	ILE
3	D	1155	ILE
3	D	1163	VAL
3	D	1170	LYS
3	D	1177	ILE
3	D	1186	TYR
3	D	1194	ARG
3	D	1202	GLU
3	D	1221	LEU
3	D	1255	VAL
3	D	1273	ASP
3	D	1274	PHE
3	D	1275	LEU
3	D	1278	GLU
3	D	1281	GLU
3	D	1284	ARG
3	D	1285	VAL
3	D	1289	ASN
3	D	1293	GLU
3	D	1298	VAL
3	D	1333	THR
3	D	1343	GLU
4	E	3	ARG
4	E	5	THR
4	E	13	ILE
4	E	16	ARG

Continued on next page...

Continued from previous page...

Mol	Chain	Res	Type
4	E	28	ARG
4	E	39	VAL
4	E	46	THR
4	E	58	LEU
5	F	98	VAL
5	F	100	MET
5	F	102	MET
5	F	154	GLU
5	F	266	PHE
5	F	267	ASP
5	F	297	MET
5	F	301	ASN
5	F	306	PHE
5	F	310	GLU
5	F	335	GLU
5	F	341	LEU
5	F	395	THR
5	F	401	PHE
5	F	417	ASP
5	F	422	ARG
5	F	429	THR
5	F	437	GLN
5	F	445	ASP
5	F	449	THR
5	F	450	ILE
5	F	471	LEU
5	F	472	GLN
5	F	479	THR
5	F	485	GLU
5	F	486	ARG
5	F	488	LEU
5	F	489	MET
5	F	491	GLU
5	F	508	GLU
5	F	530	LEU
5	F	547	VAL
5	F	558	VAL
5	F	561	MET
5	F	566	ASP
5	F	568	ASN
5	F	572	THR
5	F	573	LEU

Continued on next page...

Continued from previous page...

Mol	Chain	Res	Type
5	F	580	PHE
5	F	587	ILE
5	F	603	ARG
5	F	606	VAL
5	F	612	ASP
1	G	9	LEU
1	G	13	LEU
1	G	50	SER
1	G	61	ILE
1	G	74	VAL
1	G	115	ILE
1	G	133	LEU
1	G	145	LYS
1	G	165	GLU
1	G	215	GLU
1	G	219	ARG
1	G	231	PHE
1	H	6	THR
1	H	18	GLN
1	H	29	GLU
1	H	58	GLU
1	H	60	GLU
1	H	65	LEU
1	H	75	GLN
1	H	79	LEU
1	H	80	GLU
1	H	97	GLU
1	H	107	ILE
1	H	110	VAL
1	H	124	VAL
1	H	134	THR
1	H	183	ILE
1	H	193	GLU
2	I	4	SER
2	I	11	ILE
2	I	22	LEU
2	I	39	ILE
2	I	60	GLN
2	I	70	TYR
2	I	82	VAL
2	I	85	CYS
2	I	90	VAL

Continued on next page...

Continued from previous page...

Mol	Chain	Res	Type
2	I	91	THR
2	I	115	LYS
2	I	116	ASP
2	I	117	ILE
2	I	118	LYS
2	I	119	GLU
2	I	121	GLU
2	I	132	ASP
2	I	167	SER
2	I	189	ASP
2	I	285	ILE
2	I	299	LYS
2	I	306	THR
2	I	320	ASP
2	I	360	LEU
2	I	369	MET
2	I	377	THR
2	I	394	ARG
2	I	419	ILE
2	I	423	ASP
2	I	434	ASP
2	I	445	ILE
2	I	484	LEU
2	I	485	ASP
2	I	486	THR
2	I	490	GLN
2	I	493	ILE
2	I	496	LYS
2	I	538	LEU
2	I	539	THR
2	I	542	ARG
2	I	554	HIS
2	I	589	THR
2	I	604	HIS
2	I	607	SER
2	I	609	ILE
2	I	615	VAL
2	I	620	ASN
2	I	623	LEU
2	I	633	LEU
2	I	639	LYS
2	I	672	GLU

Continued on next page...

Continued from previous page...

Mol	Chain	Res	Type
2	I	680	LEU
2	I	692	THR
2	I	697	LYS
2	I	705	GLU
2	I	714	VAL
2	I	748	ILE
2	I	773	LEU
2	I	781	ASP
2	I	788	SER
2	I	799	ASN
2	I	800	MET
2	I	814	ASP
2	I	819	SER
2	I	826	ASP
2	I	840	SER
2	I	859	GLU
2	I	878	THR
2	I	890	LYS
2	I	892	GLU
2	I	895	LEU
2	I	944	ARG
2	I	946	LEU
2	I	951	MET
2	I	974	ARG
2	I	984	VAL
2	I	992	LEU
2	I	1002	LEU
2	I	1006	GLU
2	I	1040	ASP
2	I	1073	LYS
2	I	1082	ILE
2	I	1083	GLU
2	I	1108	ASN
2	I	1109	ILE
2	I	1114	GLU
2	I	1134	GLN
2	I	1136	GLN
2	I	1146	GLN
2	I	1151	LEU
2	I	1156	ARG
2	I	1159	VAL
2	I	1198	LEU

Continued on next page...

Continued from previous page...

Mol	Chain	Res	Type
2	I	1210	ILE
2	I	1237	HIS
2	I	1238	LEU
2	I	1246	ARG
2	I	1264	GLN
2	I	1265	PHE
2	I	1310	ASP
2	I	1327	LEU
2	I	1331	ARG
2	I	1341	ASP
2	I	1342	GLU
3	J	18	ASP
3	J	26	SER
3	J	29	MET
3	J	46	TYR
3	J	54	ASP
3	J	79	LYS
3	J	84	ILE
3	J	94	GLN
3	J	95	THR
3	J	159	ILE
3	J	169	LEU
3	J	172	PHE
3	J	175	GLU
3	J	217	LEU
3	J	251	PRO
3	J	252	LEU
3	J	312	ARG
3	J	324	LEU
3	J	330	MET
3	J	334	LYS
3	J	352	ARG
3	J	363	LEU
3	J	374	LEU
3	J	425	ARG
3	J	454	CYS
3	J	490	ILE
3	J	506	VAL
3	J	513	MET
3	J	514	THR
3	J	523	GLU
3	J	536	LEU

Continued on next page...

Continued from previous page...

Mol	Chain	Res	Type
3	J	545	HIS
3	J	547	ARG
3	J	567	THR
3	J	568	SER
3	J	641	ILE
3	J	646	ILE
3	J	660	GLU
3	J	661	VAL
3	J	678	ARG
3	J	680	ASN
3	J	683	ILE
3	J	685	ILE
3	J	697	MET
3	J	698	MET
3	J	701	LEU
3	J	702	GLN
3	J	704	GLU
3	J	707	ILE
3	J	708	ASN
3	J	710	ASP
3	J	712	GLN
3	J	717	VAL
3	J	720	ASN
3	J	740	LEU
3	J	746	LEU
3	J	754	ILE
3	J	770	LEU
3	J	788	LEU
3	J	798	ARG
3	J	803	VAL
3	J	805	GLN
3	J	810	THR
3	J	844	THR
3	J	847	ASP
3	J	848	VAL
3	J	849	LEU
3	J	853	THR
3	J	857	LEU
3	J	858	VAL
3	J	860	ARG
3	J	881	LYS
3	J	897	HIS

Continued on next page...

Continued from previous page...

Mol	Chain	Res	Type
3	J	908	ILE
3	J	918	ILE
3	J	972	LYS
3	J	987	GLU
3	J	992	LYS
3	J	994	SER
3	J	997	VAL
3	J	1010	GLN
3	J	1017	VAL
3	J	1155	ILE
3	J	1163	VAL
3	J	1170	LYS
3	J	1177	ILE
3	J	1186	TYR
3	J	1194	ARG
3	J	1202	GLU
3	J	1221	LEU
3	J	1255	VAL
3	J	1273	ASP
3	J	1274	PHE
3	J	1275	LEU
3	J	1278	GLU
3	J	1281	GLU
3	J	1284	ARG
3	J	1285	VAL
3	J	1289	ASN
3	J	1293	GLU
3	J	1298	VAL
3	J	1333	THR
3	J	1343	GLU
4	K	13	ILE
4	K	39	VAL
4	K	46	THR
4	K	58	LEU
5	L	98	VAL
5	L	100	MET
5	L	102	MET
5	L	154	GLU
5	L	266	PHE
5	L	267	ASP
5	L	297	MET
5	L	301	ASN

Continued on next page...

Continued from previous page...

Mol	Chain	Res	Type
5	L	306	PHE
5	L	310	GLU
5	L	335	GLU
5	L	341	LEU
5	L	395	THR
5	L	401	PHE
5	L	417	ASP
5	L	422	ARG
5	L	429	THR
5	L	437	GLN
5	L	445	ASP
5	L	449	THR
5	L	450	ILE
5	L	471	LEU
5	L	472	GLN
5	L	479	THR
5	L	485	GLU
5	L	486	ARG
5	L	488	LEU
5	L	489	MET
5	L	491	GLU
5	L	494	ILE
5	L	508	GLU
5	L	530	LEU
5	L	547	VAL
5	L	558	VAL
5	L	561	MET
5	L	566	ASP
5	L	568	ASN
5	L	572	THR
5	L	573	LEU
5	L	580	PHE
5	L	587	ILE
5	L	603	ARG
5	L	606	VAL
5	L	612	ASP
5	L	613	ASP

Sometimes sidechains can be flipped to improve hydrogen bonding and reduce clashes. All (72) such sidechains are listed below:

Mol	Chain	Res	Type
2	C	69	GLN

Continued on next page...

Continued from previous page...

Mol	Chain	Res	Type
2	C	120	GLN
2	C	139	ASN
2	C	494	ASN
2	C	628	HIS
2	C	688	GLN
2	C	1116	HIS
2	C	1134	GLN
2	C	1136	GLN
2	C	1146	GLN
2	C	1237	HIS
2	C	1288	GLN
2	C	1313	HIS
2	C	1314	GLN
3	D	94	GLN
3	D	200	GLN
3	D	266	ASN
3	D	365	GLN
3	D	477	GLN
3	D	669	GLN
3	D	702	GLN
3	D	716	GLN
3	D	861	ASN
3	D	910	ASN
3	D	929	GLN
3	D	1218	HIS
3	D	1227	HIS
3	D	1244	GLN
3	D	1259	GLN
4	E	7	GLN
5	F	131	GLN
5	F	246	GLN
5	F	362	ASN
5	F	396	ASN
5	F	406	GLN
5	F	446	GLN
5	F	472	GLN
5	F	518	HIS
2	I	69	GLN
2	I	139	ASN
2	I	494	ASN
2	I	628	HIS
2	I	688	GLN

Continued on next page...

Continued from previous page...

Mol	Chain	Res	Type
2	I	1116	HIS
2	I	1134	GLN
2	I	1136	GLN
2	I	1146	GLN
2	I	1237	HIS
2	I	1288	GLN
2	I	1314	GLN
3	J	94	GLN
3	J	200	GLN
3	J	266	ASN
3	J	365	GLN
3	J	477	GLN
3	J	669	GLN
3	J	702	GLN
3	J	716	GLN
3	J	861	ASN
3	J	910	ASN
3	J	929	GLN
3	J	1218	HIS
3	J	1244	GLN
3	J	1259	GLN
4	K	7	GLN
5	L	131	GLN
5	L	246	GLN
5	L	362	ASN
5	L	396	ASN
5	L	406	GLN
5	L	446	GLN
5	L	518	HIS

5.3.3 RNA [i](#)

There are no RNA molecules in this entry.

5.4 Non-standard residues in protein, DNA, RNA chains [i](#)

There are no non-standard protein/DNA/RNA residues in this entry.

5.5 Carbohydrates [i](#)

There are no monosaccharides in this entry.

5.6 Ligand geometry [i](#)

Of 8 ligands modelled in this entry, 6 are monoatomic - leaving 2 for Mogul analysis.

In the following table, the Counts columns list the number of bonds (or angles) for which Mogul statistics could be retrieved, the number of bonds (or angles) that are observed in the model and the number of bonds (or angles) that are defined in the Chemical Component Dictionary. The Link column lists molecule types, if any, to which the group is linked. The Z score for a bond length (or angle) is the number of standard deviations the observed value is removed from the expected value. A bond length (or angle) with $|Z| > 2$ is considered an outlier worth inspection. RMSZ is the root-mean-square of all Z scores of the bond lengths (or angles).

Mol	Type	Chain	Res	Link	Bond lengths			Bond angles		
					Counts	RMSZ	# Z > 2	Counts	RMSZ	# Z > 2
6	42S	I	1401	-	20,21,21	1.03	1 (5%)	27,29,29	1.71	6 (22%)
6	42S	C	1401	-	20,21,21	1.04	1 (5%)	27,29,29	1.72	6 (22%)

In the following table, the Chirals column lists the number of chiral outliers, the number of chiral centers analysed, the number of these observed in the model and the number defined in the Chemical Component Dictionary. Similar counts are reported in the Torsion and Rings columns. '-' means no outliers of that kind were identified.

Mol	Type	Chain	Res	Link	Chirals	Torsions	Rings
6	42S	I	1401	-	-	0/16/16/16	0/2/2/2
6	42S	C	1401	-	-	0/16/16/16	0/2/2/2

All (2) bond length outliers are listed below:

Mol	Chain	Res	Type	Atoms	Z	Observed(Å)	Ideal(Å)
6	C	1401	42S	O20-N19	-3.11	1.31	1.40
6	I	1401	42S	O20-N19	-3.10	1.31	1.40

All (12) bond angle outliers are listed below:

Mol	Chain	Res	Type	Atoms	Z	Observed(°)	Ideal(°)
6	I	1401	42S	N07-C08-N19	6.07	132.84	123.68
6	C	1401	42S	N07-C08-N19	6.03	132.78	123.68
6	I	1401	42S	C02-C03-C04	3.38	123.77	119.72
6	C	1401	42S	C02-C03-C04	3.15	123.49	119.72
6	C	1401	42S	C13-C12-C11	-2.60	118.03	120.76
6	C	1401	42S	C09-C08-N07	2.57	124.58	116.30
6	I	1401	42S	C09-C08-N07	2.55	124.50	116.30
6	I	1401	42S	C13-C12-C11	-2.49	118.14	120.76
6	C	1401	42S	C05-C04-C03	-2.37	115.80	119.03

Continued on next page...

Continued from previous page...

Mol	Chain	Res	Type	Atoms	Z	Observed(°)	Ideal(°)
6	I	1401	42S	C05-C04-C03	-2.21	116.01	119.03
6	C	1401	42S	C12-C11-C10	2.06	121.72	117.76
6	I	1401	42S	C12-C11-C10	2.06	121.72	117.76

There are no chirality outliers.

There are no torsion outliers.

There are no ring outliers.

2 monomers are involved in 4 short contacts:

Mol	Chain	Res	Type	Clashes	Symm-Clashes
6	I	1401	42S	2	0
6	C	1401	42S	2	0

The following is a two-dimensional graphical depiction of Mogul quality analysis of bond lengths, bond angles, torsion angles, and ring geometry for all instances of the Ligand of Interest. In addition, ligands with molecular weight > 250 and outliers as shown on the validation Tables will also be included. For torsion angles, if less than 5% of the Mogul distribution of torsion angles is within 10 degrees of the torsion angle in question, then that torsion angle is considered an outlier. Any bond that is central to one or more torsion angles identified as an outlier by Mogul will be highlighted in the graph. For rings, the root-mean-square deviation (RMSD) between the ring in question and similar rings identified by Mogul is calculated over all ring torsion angles. If the average RMSD is greater than 60 degrees and the minimal RMSD between the ring in question and any Mogul-identified rings is also greater than 60 degrees, then that ring is considered an outlier. The outliers are highlighted in purple. The color gray indicates Mogul did not find sufficient equivalents in the CSD to analyse the geometry.

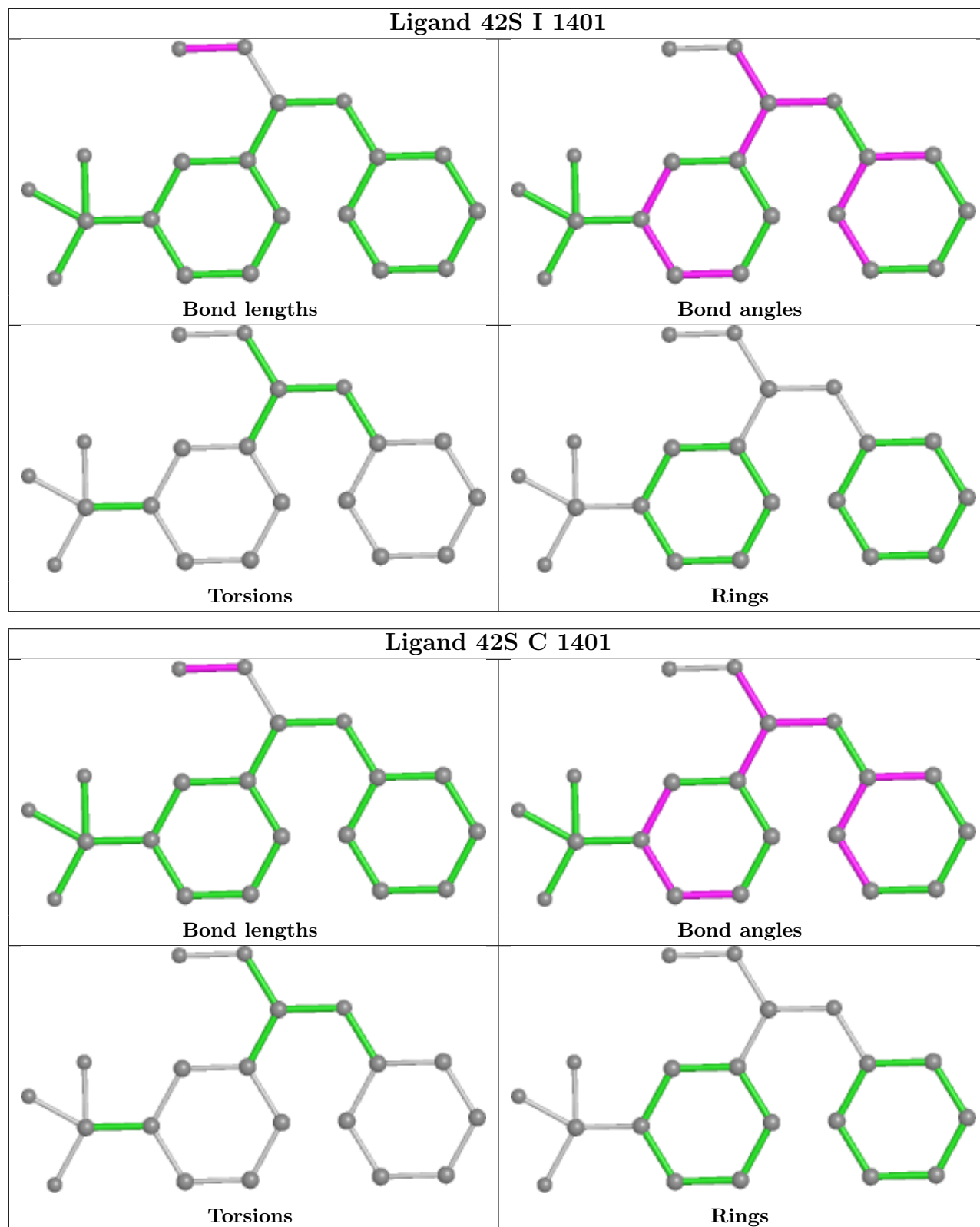

5.7 Other polymers [\(i\)](#)

There are no such residues in this entry.

5.8 Polymer linkage issues

There are no chain breaks in this entry.

6 Fit of model and data

6.1 Protein, DNA and RNA chains

In the following table, the column labelled ‘#RSRZ > 2’ contains the number (and percentage) of RSRZ outliers, followed by percent RSRZ outliers for the chain as percentile scores relative to all X-ray entries and entries of similar resolution. The OWAB column contains the minimum, median, 95th percentile and maximum values of the occupancy-weighted average B-factor per residue. The column labelled ‘Q < 0.9’ lists the number of (and percentage) of residues with an average occupancy less than 0.9.

Mol	Chain	Analysed	<RSRZ>	#RSRZ>2	OWAB(Å ²)	Q<0.9
1	A	224/239 (93%)	-0.24	1 (0%) 92 88	50, 88, 138, 174	0
1	B	220/239 (92%)	0.43	19 (8%) 10 8	67, 131, 170, 190	0
1	G	228/239 (95%)	0.11	7 (3%) 49 36	77, 126, 157, 195	0
1	H	217/239 (90%)	0.25	8 (3%) 41 30	88, 136, 160, 178	0
2	C	1340/1342 (99%)	-0.16	14 (1%) 82 73	29, 80, 138, 174	0
2	I	1340/1342 (99%)	-0.07	30 (2%) 62 50	45, 103, 155, 191	0
3	D	1166/1407 (82%)	-0.11	25 (2%) 63 52	26, 79, 150, 184	0
3	J	1236/1407 (87%)	-0.03	46 (3%) 41 30	42, 98, 154, 175	0
4	E	89/91 (97%)	-0.36	0 100 100	35, 78, 114, 130	0
4	K	79/91 (86%)	-0.24	2 (2%) 57 45	62, 95, 151, 168	0
5	F	470/522 (90%)	-0.02	24 (5%) 28 21	48, 119, 167, 189	0
5	L	469/522 (89%)	-0.03	17 (3%) 42 32	59, 123, 167, 188	0
All	All	7078/7680 (92%)	-0.06	193 (2%) 54 42	26, 99, 157, 195	0

All (193) RSRZ outliers are listed below:

Mol	Chain	Res	Type	RSRZ
1	B	146	VAL	9.4
1	B	69	SER	7.5
1	B	67	GLU	7.3
5	L	305	LEU	7.2
3	J	998	PRO	6.0
5	L	290	LEU	5.7
1	B	66	HIS	5.5
3	D	878	ASP	5.3
3	J	1198	VAL	5.3
2	C	266	GLY	5.3
3	J	1188	GLU	5.2

Continued on next page...

Continued from previous page...

Mol	Chain	Res	Type	RSRZ
5	L	294	GLN	5.2
3	D	1198	VAL	5.1
1	B	172	LEU	5.1
1	B	160	HIS	4.9
5	L	167	ASP	4.8
1	B	78	ILE	4.7
2	I	979	LEU	4.6
5	L	287	ILE	4.5
5	L	304	THR	4.5
5	F	283	GLN	4.5
5	F	167	ASP	4.4
2	I	1002	LEU	4.2
3	D	1204	VAL	4.2
5	F	301	ASN	4.2
1	B	158	ARG	4.1
3	J	975	ILE	4.1
5	F	287	ILE	4.0
2	C	1000	LEU	4.0
2	C	251	ALA	4.0
5	L	317	ASN	3.8
5	L	315	TRP	3.8
3	D	879	ALA	3.8
1	B	159	ILE	3.7
3	J	1294	ALA	3.7
5	L	318	ALA	3.6
5	L	314	THR	3.5
5	F	321	ALA	3.4
3	J	1000	GLY	3.4
5	F	304	THR	3.4
1	B	68	TYR	3.4
1	G	211	ILE	3.3
2	C	252	SER	3.3
5	F	319	ALA	3.3
5	F	290	LEU	3.3
2	I	1003	THR	3.2
3	J	1186	TYR	3.2
2	I	987	GLU	3.2
5	L	165	PHE	3.2
1	B	98	VAL	3.2
3	J	1175	LEU	3.2
3	J	974	VAL	3.2
2	I	996	ARG	3.2

Continued on next page...

Continued from previous page...

Mol	Chain	Res	Type	RSRZ
1	B	90	VAL	3.2
3	J	1295	ASN	3.1
3	D	1210	ILE	3.1
5	L	319	ALA	3.1
2	I	999	GLU	3.1
2	I	1021	LEU	3.1
3	J	999	TYR	3.1
2	C	165	HIS	3.0
5	F	158	LEU	3.0
3	J	1273	ASP	3.0
5	L	609	SER	3.0
5	F	293	GLU	3.0
3	D	1173	ARG	2.9
3	J	1001	ALA	2.9
3	J	857	LEU	2.9
3	D	849	LEU	2.9
3	D	1199	PHE	2.9
1	H	28	LEU	2.9
3	D	1291	GLU	2.9
1	B	99	ILE	2.8
2	I	882	ILE	2.8
3	D	1200	GLU	2.8
3	J	1161	GLY	2.8
3	J	955	LYS	2.8
3	D	857	LEU	2.7
2	I	620	ASN	2.7
3	J	957	SER	2.7
2	C	265	LYS	2.7
5	F	313	ASP	2.7
3	J	768	ASN	2.7
2	I	995	ASP	2.7
5	F	165	PHE	2.7
3	J	997	VAL	2.7
5	F	318	ALA	2.7
3	D	1212	ASP	2.6
3	J	732	GLY	2.6
5	L	610	PHE	2.6
3	D	827	GLU	2.6
1	A	227	GLN	2.6
3	D	1168	GLU	2.6
3	D	340	GLN	2.6
5	F	314	THR	2.6

Continued on next page...

Continued from previous page...

Mol	Chain	Res	Type	RSRZ
1	H	146	VAL	2.6
2	C	982	GLY	2.5
5	F	259	PHE	2.5
3	J	1204	VAL	2.5
5	L	293	GLU	2.5
3	J	976	THR	2.5
2	I	1004	ASP	2.5
3	J	1181	ASP	2.5
3	D	1169	THR	2.5
3	D	1190	ILE	2.5
3	J	930	LEU	2.5
1	G	200	LYS	2.5
1	G	194	GLN	2.5
3	D	1172	LYS	2.5
2	C	1002	LEU	2.5
3	J	218	THR	2.4
2	I	978	VAL	2.4
3	D	858	VAL	2.4
1	G	90	VAL	2.4
2	C	317	LEU	2.4
5	F	286	LEU	2.4
2	I	725	GLN	2.4
5	F	607	LEU	2.4
5	F	315	TRP	2.4
2	I	975	ILE	2.4
3	D	880	VAL	2.4
2	I	720	ARG	2.4
2	I	492	MET	2.4
1	B	173	VAL	2.3
1	H	58	GLU	2.3
5	F	289	LYS	2.3
2	I	232	ILE	2.3
1	B	120	ASP	2.3
3	J	956	GLY	2.3
5	F	300	LYS	2.3
4	K	75	GLN	2.3
5	F	326	TRP	2.3
3	J	973	LEU	2.3
5	F	297	MET	2.3
3	D	1203	ARG	2.3
3	J	1168	GLU	2.3
5	L	480	PRO	2.2

Continued on next page...

Continued from previous page...

Mol	Chain	Res	Type	RSRZ
1	H	172	LEU	2.2
3	J	856	ILE	2.2
4	K	2	ALA	2.2
3	J	683	ILE	2.2
2	I	982	GLY	2.2
3	J	1008	GLY	2.2
3	J	1013	GLY	2.2
5	L	291	CYS	2.2
2	C	250	THR	2.2
2	I	1008	GLN	2.2
3	J	212	THR	2.2
1	B	85	LEU	2.2
1	G	26	VAL	2.2
3	J	1201	GLY	2.2
3	J	1025	MET	2.2
1	G	98	VAL	2.2
2	I	231	GLU	2.2
2	I	282	VAL	2.2
5	F	306	PHE	2.2
2	I	969	ALA	2.2
3	J	977	SER	2.2
3	J	971	GLY	2.2
2	I	124	MET	2.2
1	B	144	ILE	2.2
1	H	67	GLU	2.2
1	H	52	PRO	2.1
1	H	132	HIS	2.1
2	C	489	PRO	2.1
2	I	1180	MET	2.1
3	D	1175	LEU	2.1
3	J	670	SER	2.1
3	J	965	SER	2.1
2	I	489	PRO	2.1
3	J	859	PRO	2.1
1	B	147	GLN	2.1
2	I	721	GLY	2.1
3	D	1201	GLY	2.1
3	J	1195	GLN	2.1
2	I	973	SER	2.1
2	I	1010	GLN	2.1
3	D	830	ASP	2.1
2	C	999	GLU	2.1

Continued on next page...

Continued from previous page...

Mol	Chain	Res	Type	RSRZ
2	I	983	GLY	2.1
3	J	596	LEU	2.1
1	H	173	VAL	2.1
3	J	849	LEU	2.0
3	J	1187	GLU	2.0
1	G	100	LEU	2.0
5	F	312	SER	2.0
1	B	114	ASP	2.0
2	I	596	ASP	2.0
3	D	856	ILE	2.0
2	C	120	GLN	2.0
3	J	1028	ILE	2.0
3	J	963	VAL	2.0
2	C	1001	GLY	2.0

6.2 Non-standard residues in protein, DNA, RNA chains [i](#)

There are no non-standard protein/DNA/RNA residues in this entry.

6.3 Carbohydrates [i](#)

There are no monosaccharides in this entry.

6.4 Ligands [i](#)

In the following table, the Atoms column lists the number of modelled atoms in the group and the number defined in the chemical component dictionary. The B-factors column lists the minimum, median, 95th percentile and maximum values of B factors of atoms in the group. The column labelled 'Q<0.9' lists the number of atoms with occupancy less than 0.9.

Mol	Type	Chain	Res	Atoms	RSCC	RSR	B-factors(Å ²)	Q<0.9
8	ZN	D	1503	1/1	0.46	0.41	420,420,420,420	0
7	MG	J	1501	1/1	0.69	0.85	82,82,82,82	0
7	MG	D	1501	1/1	0.80	0.27	67,67,67,67	0
8	ZN	J	1503	1/1	0.88	0.46	490,490,490,490	0
6	42S	I	1401	20/20	0.90	0.40	75,85,110,123	0
6	42S	C	1401	20/20	0.92	0.56	58,77,93,101	0
8	ZN	D	1502	1/1	0.94	0.24	429,429,429,429	0
8	ZN	J	1502	1/1	0.95	0.17	199,199,199,199	0

The following is a graphical depiction of the model fit to experimental electron density of all instances of the Ligand of Interest. In addition, ligands with molecular weight > 250 and outliers as shown on the geometry validation Tables will also be included. Each fit is shown from different orientation to approximate a three-dimensional view.

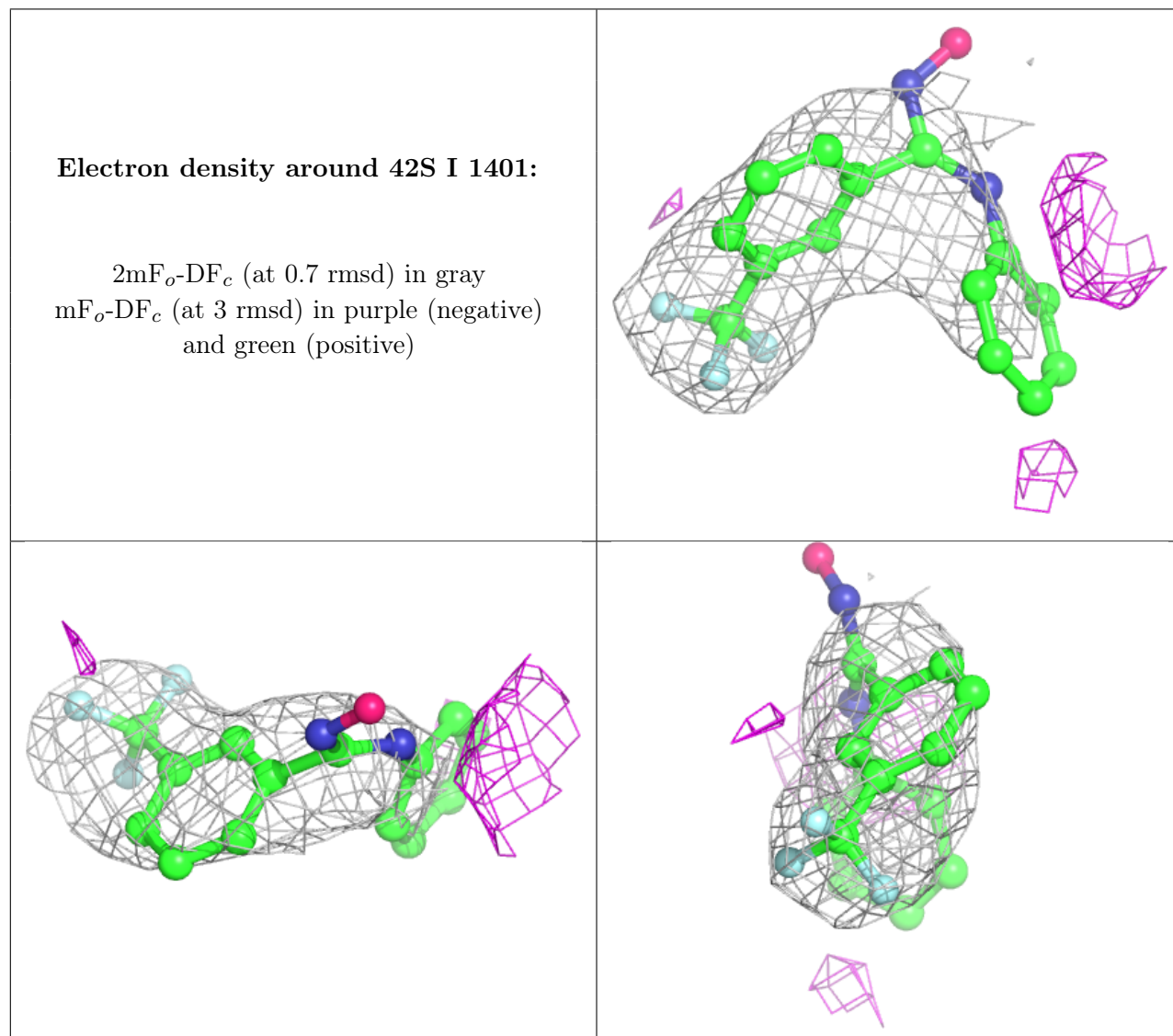

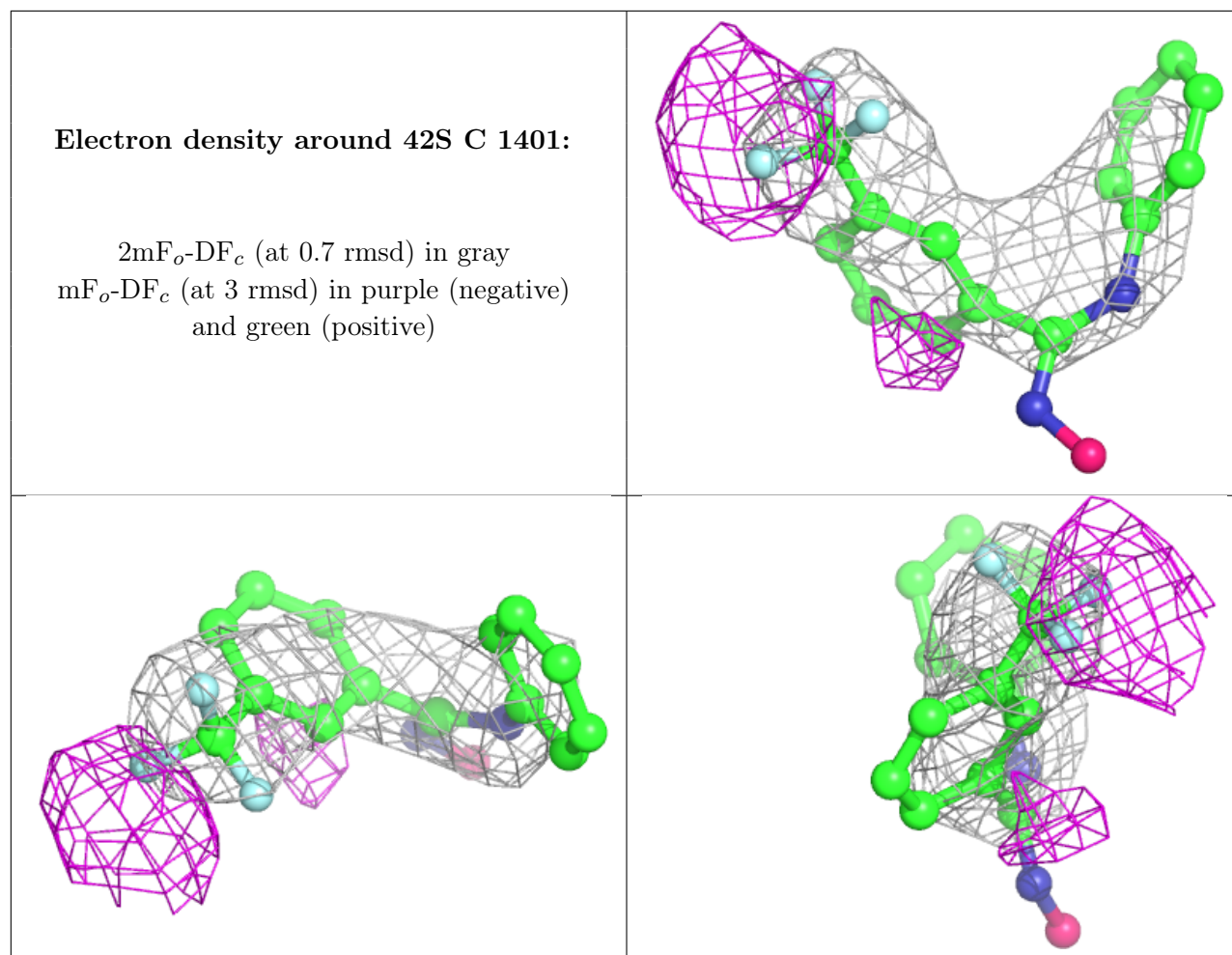

6.5 Other polymers [\(i\)](#)

There are no such residues in this entry.