



Full wwPDB X-ray Structure Validation Report ⓘ

Dec 16, 2023 – 11:32 AM EST

PDB ID : 4P1Y
Title : Crystal structure of staphylococcal gamma-hemolysin prepore
Authors : Yamashita, D.; Tanaka, Y.; Tanaka, I.; Yao, M.
Deposited on : 2014-02-28
Resolution : 2.99 Å(reported)

This is a Full wwPDB X-ray Structure Validation Report for a publicly released PDB entry.

We welcome your comments at validation@mail.wwpdb.org

A user guide is available at

<https://www.wwpdb.org/validation/2017/XrayValidationReportHelp>

with specific help available everywhere you see the ⓘ symbol.

The types of validation reports are described at

<http://www.wwpdb.org/validation/2017/FAQs#types>.

The following versions of software and data (see [references ⓘ](#)) were used in the production of this report:

MolProbity : 4.02b-467
Xtriage (Phenix) : 1.13
EDS : 2.36
Percentile statistics : 20191225.v01 (using entries in the PDB archive December 25th 2019)
Refmac : 5.8.0158
CCP4 : 7.0.044 (Gargrove)
Ideal geometry (proteins) : Engh & Huber (2001)
Ideal geometry (DNA, RNA) : Parkinson et al. (1996)
Validation Pipeline (wwPDB-VP) : 2.36

1 Overall quality at a glance i

The following experimental techniques were used to determine the structure:

X-RAY DIFFRACTION

The reported resolution of this entry is 2.99 Å.

Percentile scores (ranging between 0-100) for global validation metrics of the entry are shown in the following graphic. The table shows the number of entries on which the scores are based.

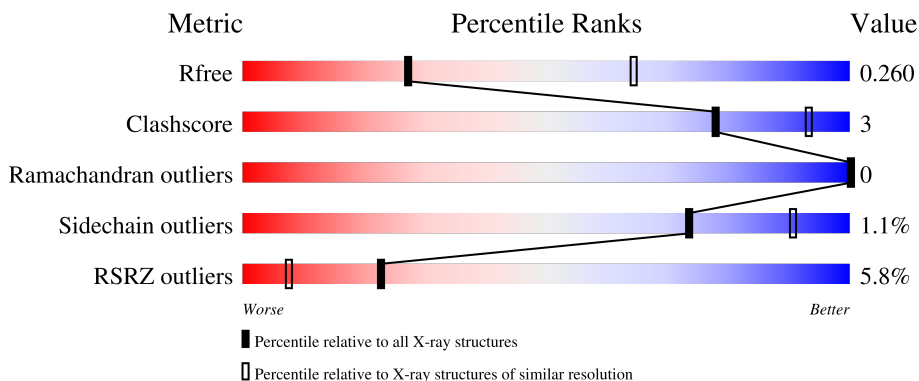



Metric	Whole archive (#Entries)	Similar resolution (#Entries, resolution range(Å))
R_{free}	130704	2092 (3.00-3.00)
Clashscore	141614	2416 (3.00-3.00)
Ramachandran outliers	138981	2333 (3.00-3.00)
Sidechain outliers	138945	2336 (3.00-3.00)
RSRZ outliers	127900	1990 (3.00-3.00)

The table below summarises the geometric issues observed across the polymeric chains and their fit to the electron density. The red, orange, yellow and green segments of the lower bar indicate the fraction of residues that contain outliers for ≥ 3 , 2, 1 and 0 types of geometric quality criteria respectively. A grey segment represents the fraction of residues that are not modelled. The numeric value for each fraction is indicated below the corresponding segment, with a dot representing fractions $\leq 5\%$. The upper red bar (where present) indicates the fraction of residues that have poor fit to the electron density. The numeric value is given above the bar.

Mol	Chain	Length	Quality of chain
1	A	309	 6% 78% 9% 14%
1	C	309	 6% 77% 9% 14%
1	E	309	 6% 77% 9% 14%
1	G	309	 6% 80% 6% 14%
2	B	290	 6% 84% 6% 9%

Continued on next page...

Continued from previous page...

Mol	Chain	Length	Quality of chain
2	D	290	 4% 84% 7% 9%
2	F	290	 4% 83% 8% 9%
2	H	290	 3% 82% 8% 9%

2 Entry composition [i](#)

There are 2 unique types of molecules in this entry. The entry contains 34011 atoms, of which 16788 are hydrogens and 0 are deuteriums.

In the tables below, the ZeroOcc column contains the number of atoms modelled with zero occupancy, the AltConf column contains the number of residues with at least one atom in alternate conformation and the Trace column contains the number of residues modelled with at most 2 atoms.

- Molecule 1 is a protein called Gamma-hemolysin component B.

Mol	Chain	Residues	Atoms						ZeroOcc	AltConf	Trace
			Total	C	H	N	O	S			
1	A	267	4239	1376	2070	367	422	4	0	0	0
1	C	266	4227	1373	2065	366	419	4	0	0	0
1	E	265	4217	1370	2060	365	418	4	0	0	0
1	G	266	4228	1373	2065	366	420	4	0	0	0

There are 48 discrepancies between the modelled and reference sequences:

Chain	Residue	Modelled	Actual	Comment	Reference
A	-8	MET	-	expression tag	UNP Q931F3
A	-7	GLY	-	expression tag	UNP Q931F3
A	-6	HIS	-	expression tag	UNP Q931F3
A	-5	HIS	-	expression tag	UNP Q931F3
A	-4	HIS	-	expression tag	UNP Q931F3
A	-3	HIS	-	expression tag	UNP Q931F3
A	-2	HIS	-	expression tag	UNP Q931F3
A	-1	HIS	-	expression tag	UNP Q931F3
A	0	ALA	-	expression tag	UNP Q931F3
A	1	MET	-	expression tag	UNP Q931F3
A	177	ALA	TRP	engineered mutation	UNP Q931F3
A	198	ALA	ARG	engineered mutation	UNP Q931F3
C	-8	MET	-	expression tag	UNP Q931F3
C	-7	GLY	-	expression tag	UNP Q931F3
C	-6	HIS	-	expression tag	UNP Q931F3
C	-5	HIS	-	expression tag	UNP Q931F3
C	-4	HIS	-	expression tag	UNP Q931F3
C	-3	HIS	-	expression tag	UNP Q931F3
C	-2	HIS	-	expression tag	UNP Q931F3
C	-1	HIS	-	expression tag	UNP Q931F3
C	0	ALA	-	expression tag	UNP Q931F3

Continued on next page...

Continued from previous page...

Chain	Residue	Modelled	Actual	Comment	Reference
C	1	MET	-	expression tag	UNP Q931F3
C	177	ALA	TRP	engineered mutation	UNP Q931F3
C	198	ALA	ARG	engineered mutation	UNP Q931F3
E	-8	MET	-	expression tag	UNP Q931F3
E	-7	GLY	-	expression tag	UNP Q931F3
E	-6	HIS	-	expression tag	UNP Q931F3
E	-5	HIS	-	expression tag	UNP Q931F3
E	-4	HIS	-	expression tag	UNP Q931F3
E	-3	HIS	-	expression tag	UNP Q931F3
E	-2	HIS	-	expression tag	UNP Q931F3
E	-1	HIS	-	expression tag	UNP Q931F3
E	0	ALA	-	expression tag	UNP Q931F3
E	1	MET	-	expression tag	UNP Q931F3
E	177	ALA	TRP	engineered mutation	UNP Q931F3
E	198	ALA	ARG	engineered mutation	UNP Q931F3
G	-8	MET	-	expression tag	UNP Q931F3
G	-7	GLY	-	expression tag	UNP Q931F3
G	-6	HIS	-	expression tag	UNP Q931F3
G	-5	HIS	-	expression tag	UNP Q931F3
G	-4	HIS	-	expression tag	UNP Q931F3
G	-3	HIS	-	expression tag	UNP Q931F3
G	-2	HIS	-	expression tag	UNP Q931F3
G	-1	HIS	-	expression tag	UNP Q931F3
G	0	ALA	-	expression tag	UNP Q931F3
G	1	MET	-	expression tag	UNP Q931F3
G	177	ALA	TRP	engineered mutation	UNP Q931F3
G	198	ALA	ARG	engineered mutation	UNP Q931F3

- Molecule 2 is a protein called Gamma-hemolysin component A.

Mol	Chain	Residues	Atoms						ZeroOcc	AltConf	Trace
			Total	C	H	N	O	S			
2	B	264	4275	1364	2132	370	406	3	0	0	0
2	D	264	4275	1364	2132	370	406	3	0	0	0
2	F	264	4275	1364	2132	370	406	3	0	0	0
2	H	264	4275	1364	2132	370	406	3	0	0	0

There are 88 discrepancies between the modelled and reference sequences:

Chain	Residue	Modelled	Actual	Comment	Reference
B	-9	MET	-	expression tag	UNP P0A071
B	-8	GLY	-	expression tag	UNP P0A071
B	-7	HIS	-	expression tag	UNP P0A071
B	-6	HIS	-	expression tag	UNP P0A071
B	-5	HIS	-	expression tag	UNP P0A071
B	-4	HIS	-	expression tag	UNP P0A071
B	-3	HIS	-	expression tag	UNP P0A071
B	-2	HIS	-	expression tag	UNP P0A071
B	-1	ALA	-	expression tag	UNP P0A071
B	0	MET	-	expression tag	UNP P0A071
B	1	GLU	-	expression tag	UNP P0A071
B	2	ASN	-	expression tag	UNP P0A071
B	3	LYS	-	expression tag	UNP P0A071
B	4	ILE	-	expression tag	UNP P0A071
B	5	GLU	-	expression tag	UNP P0A071
B	6	ASP	-	expression tag	UNP P0A071
B	7	ILE	-	expression tag	UNP P0A071
B	8	GLY	-	expression tag	UNP P0A071
B	9	GLN	-	expression tag	UNP P0A071
B	10	GLY	-	expression tag	UNP P0A071
B	11	ALA	-	expression tag	UNP P0A071
B	12	GLU	-	expression tag	UNP P0A071
D	-9	MET	-	expression tag	UNP P0A071
D	-8	GLY	-	expression tag	UNP P0A071
D	-7	HIS	-	expression tag	UNP P0A071
D	-6	HIS	-	expression tag	UNP P0A071
D	-5	HIS	-	expression tag	UNP P0A071
D	-4	HIS	-	expression tag	UNP P0A071
D	-3	HIS	-	expression tag	UNP P0A071
D	-2	HIS	-	expression tag	UNP P0A071
D	-1	ALA	-	expression tag	UNP P0A071
D	0	MET	-	expression tag	UNP P0A071
D	1	GLU	-	expression tag	UNP P0A071
D	2	ASN	-	expression tag	UNP P0A071
D	3	LYS	-	expression tag	UNP P0A071
D	4	ILE	-	expression tag	UNP P0A071
D	5	GLU	-	expression tag	UNP P0A071
D	6	ASP	-	expression tag	UNP P0A071
D	7	ILE	-	expression tag	UNP P0A071
D	8	GLY	-	expression tag	UNP P0A071
D	9	GLN	-	expression tag	UNP P0A071
D	10	GLY	-	expression tag	UNP P0A071
D	11	ALA	-	expression tag	UNP P0A071

Continued on next page...

Continued from previous page...

Chain	Residue	Modelled	Actual	Comment	Reference
D	12	GLU	-	expression tag	UNP P0A071
F	-9	MET	-	expression tag	UNP P0A071
F	-8	GLY	-	expression tag	UNP P0A071
F	-7	HIS	-	expression tag	UNP P0A071
F	-6	HIS	-	expression tag	UNP P0A071
F	-5	HIS	-	expression tag	UNP P0A071
F	-4	HIS	-	expression tag	UNP P0A071
F	-3	HIS	-	expression tag	UNP P0A071
F	-2	HIS	-	expression tag	UNP P0A071
F	-1	ALA	-	expression tag	UNP P0A071
F	0	MET	-	expression tag	UNP P0A071
F	1	GLU	-	expression tag	UNP P0A071
F	2	ASN	-	expression tag	UNP P0A071
F	3	LYS	-	expression tag	UNP P0A071
F	4	ILE	-	expression tag	UNP P0A071
F	5	GLU	-	expression tag	UNP P0A071
F	6	ASP	-	expression tag	UNP P0A071
F	7	ILE	-	expression tag	UNP P0A071
F	8	GLY	-	expression tag	UNP P0A071
F	9	GLN	-	expression tag	UNP P0A071
F	10	GLY	-	expression tag	UNP P0A071
F	11	ALA	-	expression tag	UNP P0A071
F	12	GLU	-	expression tag	UNP P0A071
H	-9	MET	-	expression tag	UNP P0A071
H	-8	GLY	-	expression tag	UNP P0A071
H	-7	HIS	-	expression tag	UNP P0A071
H	-6	HIS	-	expression tag	UNP P0A071
H	-5	HIS	-	expression tag	UNP P0A071
H	-4	HIS	-	expression tag	UNP P0A071
H	-3	HIS	-	expression tag	UNP P0A071
H	-2	HIS	-	expression tag	UNP P0A071
H	-1	ALA	-	expression tag	UNP P0A071
H	0	MET	-	expression tag	UNP P0A071
H	1	GLU	-	expression tag	UNP P0A071
H	2	ASN	-	expression tag	UNP P0A071
H	3	LYS	-	expression tag	UNP P0A071
H	4	ILE	-	expression tag	UNP P0A071
H	5	GLU	-	expression tag	UNP P0A071
H	6	ASP	-	expression tag	UNP P0A071
H	7	ILE	-	expression tag	UNP P0A071
H	8	GLY	-	expression tag	UNP P0A071
H	9	GLN	-	expression tag	UNP P0A071

Continued on next page...

Continued from previous page...

Chain	Residue	Modelled	Actual	Comment	Reference
H	10	GLY	-	expression tag	UNP P0A071
H	11	ALA	-	expression tag	UNP P0A071
H	12	GLU	-	expression tag	UNP P0A071

3 Residue-property plots [i](#)

These plots are drawn for all protein, RNA, DNA and oligosaccharide chains in the entry. The first graphic for a chain summarises the proportions of the various outlier classes displayed in the second graphic. The second graphic shows the sequence view annotated by issues in geometry and electron density. Residues are color-coded according to the number of geometric quality criteria for which they contain at least one outlier: green = 0, yellow = 1, orange = 2 and red = 3 or more. A red dot above a residue indicates a poor fit to the electron density ($RSRZ > 2$). Stretches of 2 or more consecutive residues without any outlier are shown as a green connector. Residues present in the sample, but not in the model, are shown in grey.

- Molecule 1: Gamma-hemolysin component B

Chain A: 6% 78% 9% 14%

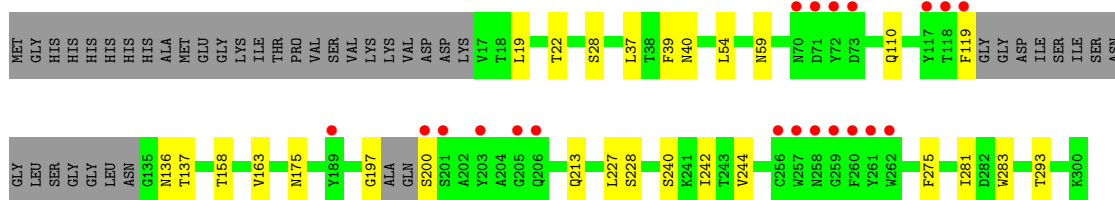

- Molecule 1: Gamma-hemolysin component B

Chain C: 6% 77% 9% 14%

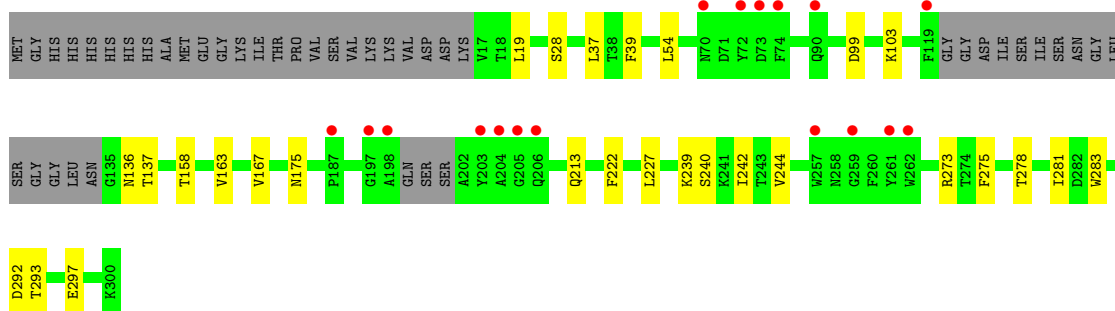

- Molecule 1: Gamma-hemolysin component B

Chain E: 6% 77% 9% 14%

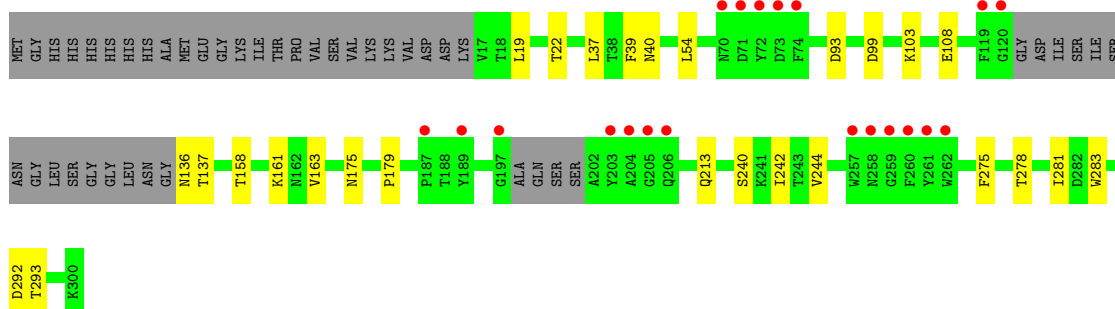

- Molecule 1: Gamma-hemolysin component B

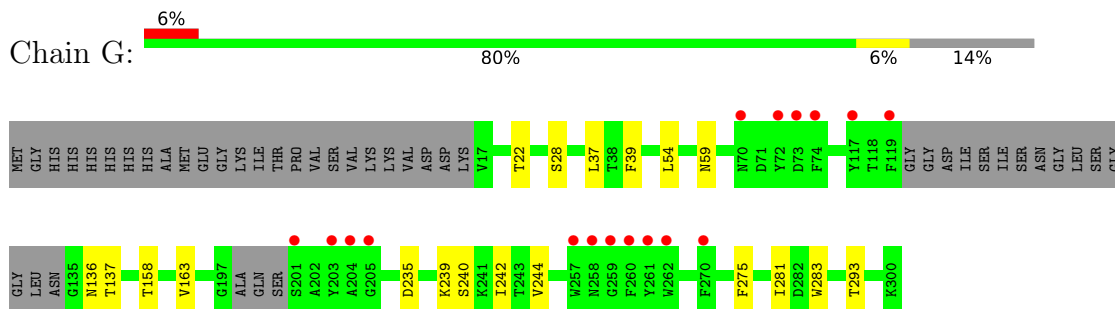

- Molecule 2: Gamma-hemolysin component A

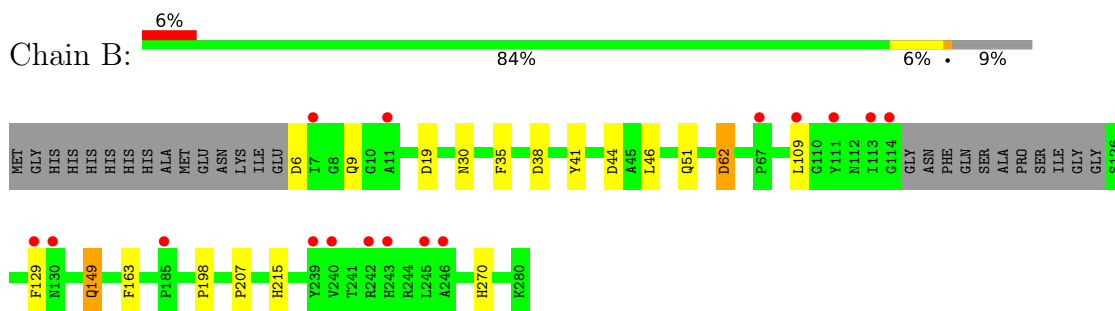

- Molecule 2: Gamma-hemolysin component A

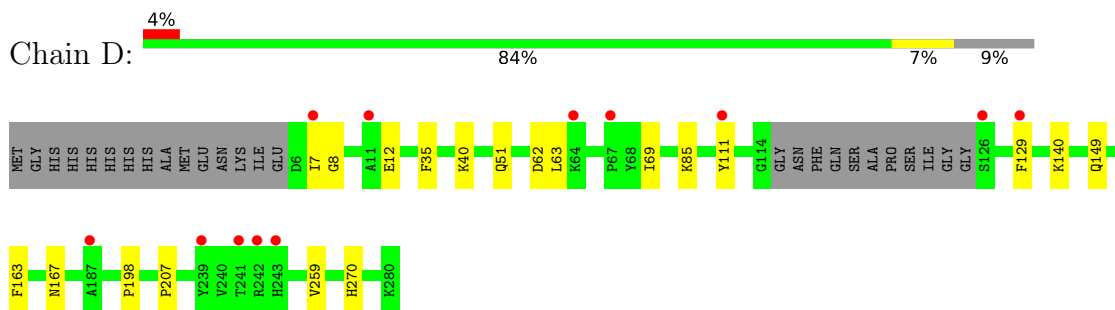

- Molecule 2: Gamma-hemolysin component A

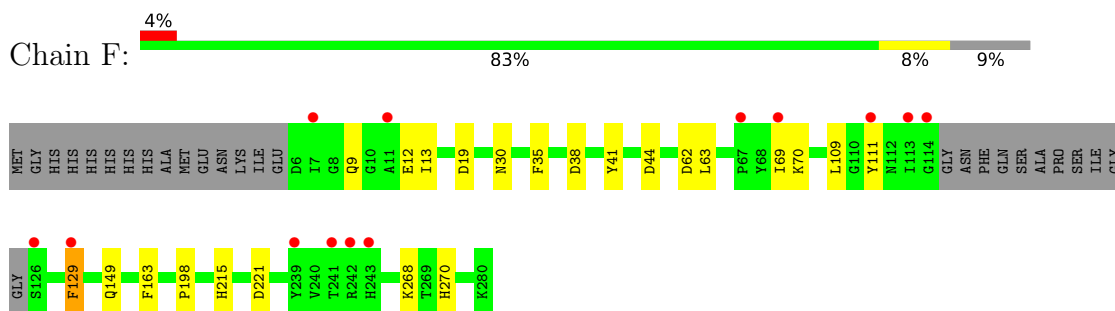

- Molecule 2: Gamma-hemolysin component A

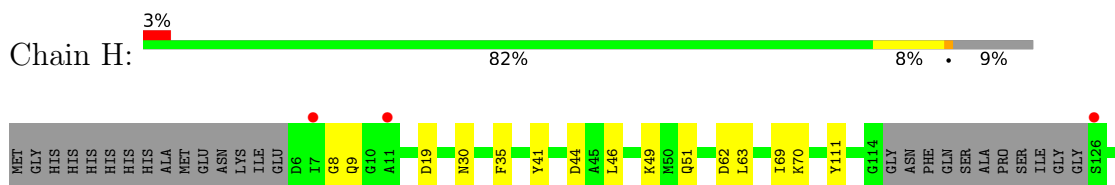

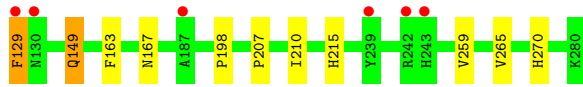

4 Data and refinement statistics

Property	Value	Source
Space group	C 1 2 1	Depositor
Cell constants a, b, c, α , β , γ	197.06Å 197.05Å 192.97Å 90.00° 99.04° 90.00°	Depositor
Resolution (Å)	44.40 – 2.99 44.40 – 2.99	Depositor EDS
% Data completeness (in resolution range)	95.5 (44.40-2.99) 95.5 (44.40-2.99)	Depositor EDS
R_{merge}	0.19	Depositor
R_{sym}	(Not available)	Depositor
$\langle I/\sigma(I) \rangle$ ¹	1.83 (at 3.01Å)	Xtrriage
Refinement program	PHENIX (phenix.refine: 1.8.2_1309)	Depositor
R, R_{free}	0.230 , 0.254 0.234 , 0.260	Depositor DCC
R_{free} test set	6970 reflections (4.99%)	wwPDB-VP
Wilson B-factor (Å ²)	47.1	Xtrriage
Anisotropy	1.101	Xtrriage
Bulk solvent k_{sol} (e/Å ³), B_{sol} (Å ²)	0.39 , 65.9	EDS
L-test for twinning ²	$\langle L \rangle = 0.45$, $\langle L^2 \rangle = 0.27$	Xtrriage
Estimated twinning fraction	No twinning to report.	Xtrriage
F_o, F_c correlation	0.89	EDS
Total number of atoms	34011	wwPDB-VP
Average B, all atoms (Å ²)	56.0	wwPDB-VP

Xtrriage's analysis on translational NCS is as follows: *The largest off-origin peak in the Patterson function is 12.01% of the height of the origin peak. No significant pseudotranslation is detected.*

¹Intensities estimated from amplitudes.

²Theoretical values of $\langle |L| \rangle$, $\langle L^2 \rangle$ for acentric reflections are 0.5, 0.333 respectively for untwinned datasets, and 0.375, 0.2 for perfectly twinned datasets.

5 Model quality [i](#)

5.1 Standard geometry [i](#)

The Z score for a bond length (or angle) is the number of standard deviations the observed value is removed from the expected value. A bond length (or angle) with $|Z| > 5$ is considered an outlier worth inspection. RMSZ is the root-mean-square of all Z scores of the bond lengths (or angles).

Mol	Chain	Bond lengths		Bond angles	
		RMSZ	# Z >5	RMSZ	# Z >5
1	A	0.38	0/2222	0.53	0/3003
1	C	0.38	0/2215	0.53	0/2994
1	E	0.38	0/2210	0.53	0/2987
1	G	0.38	0/2216	0.53	0/2995
2	B	0.38	0/2191	0.57	0/2957
2	D	0.38	0/2191	0.56	0/2957
2	F	0.38	0/2191	0.57	0/2957
2	H	0.38	0/2191	0.56	0/2957
All	All	0.38	0/17627	0.55	0/23807

There are no bond length outliers.

There are no bond angle outliers.

There are no chirality outliers.

There are no planarity outliers.

5.2 Too-close contacts [i](#)

In the following table, the Non-H and H(model) columns list the number of non-hydrogen atoms and hydrogen atoms in the chain respectively. The H(added) column lists the number of hydrogen atoms added and optimized by MolProbity. The Clashes column lists the number of clashes within the asymmetric unit, whereas Symm-Clashes lists symmetry-related clashes.

Mol	Chain	Non-H	H(model)	H(added)	Clashes	Symm-Clashes
1	A	2169	2070	2065	16	0
1	C	2162	2065	2060	17	0
1	E	2157	2060	2055	15	0
1	G	2163	2065	2060	13	0
2	B	2143	2132	2128	11	0
2	D	2143	2132	2128	11	0
2	F	2143	2132	2128	12	0
2	H	2143	2132	2128	17	0

Continued on next page...

Continued from previous page...

Mol	Chain	Non-H	H(model)	H(added)	Clashes	Symm-Clashes
All	All	17223	16788	16752	99	0

The all-atom clashscore is defined as the number of clashes found per 1000 atoms (including hydrogen atoms). The all-atom clashscore for this structure is 3.

All (99) close contacts within the same asymmetric unit are listed below, sorted by their clash magnitude.

Atom-1	Atom-2	Interatomic distance (Å)	Clash overlap (Å)
2:F:9:GLN:HB3	2:F:38:ASP:OD2	1.93	0.69
1:C:175:ASN:ND2	1:C:213:GLN:OE1	2.26	0.65
2:B:9:GLN:HB2	2:B:38:ASP:OD2	1.97	0.64
1:C:240:SER:HB3	1:C:283:TRP:HE1	1.68	0.58
1:C:136:ASN:OD1	1:C:137:THR:N	2.36	0.58
1:E:242:ILE:HD12	1:E:281:ILE:HD11	1.85	0.58
1:G:136:ASN:OD1	1:G:137:THR:N	2.38	0.56
1:G:240:SER:HB3	1:G:283:TRP:HE1	1.69	0.56
1:A:240:SER:HB3	1:A:283:TRP:HE1	1.69	0.56
1:A:136:ASN:OD1	1:A:137:THR:N	2.37	0.56
1:E:240:SER:HB3	1:E:283:TRP:HE1	1.71	0.55
1:A:242:ILE:HD12	1:A:281:ILE:HD11	1.91	0.53
2:B:19:ASP:OD1	2:B:30:ASN:ND2	2.38	0.53
1:G:37:LEU:HD21	1:G:244:VAL:HG21	1.91	0.53
1:A:37:LEU:HD21	1:A:244:VAL:HG21	1.90	0.52
1:E:37:LEU:HD21	1:E:244:VAL:HG21	1.90	0.52
1:C:242:ILE:HD12	1:C:281:ILE:HD11	1.91	0.52
2:F:35:PHE:CE2	2:F:270:HIS:HA	2.45	0.51
1:C:37:LEU:HD21	1:C:244:VAL:HG21	1.91	0.51
2:H:35:PHE:CE2	2:H:270:HIS:HA	2.45	0.51
2:D:35:PHE:CE2	2:D:270:HIS:HA	2.45	0.51
2:D:163:PHE:CE1	2:D:198:PRO:HG3	2.45	0.51
1:E:136:ASN:N	1:E:136:ASN:HD22	2.08	0.50
1:G:242:ILE:HD12	1:G:281:ILE:HD11	1.93	0.50
1:G:275:PHE:CE1	1:G:293:THR:HG23	2.47	0.50
2:B:35:PHE:CE2	2:B:270:HIS:HA	2.47	0.50
1:C:19:LEU:HD21	2:D:7:ILE:HG21	1.93	0.50
1:A:39:PHE:CE1	1:A:54:LEU:HD13	2.46	0.49
2:B:62:ASP:OD2	2:B:62:ASP:N	2.45	0.49
2:B:163:PHE:CE1	2:B:198:PRO:HG3	2.47	0.48
1:A:275:PHE:CE1	1:A:293:THR:HG23	2.48	0.48
1:C:39:PHE:CE1	1:C:54:LEU:HD13	2.49	0.48
1:C:275:PHE:CE1	1:C:293:THR:HG23	2.48	0.48

Continued on next page...

Continued from previous page...

Atom-1	Atom-2	Interatomic distance (Å)	Clash overlap (Å)
2:H:111:TYR:CE1	2:H:129:PHE:HB2	2.49	0.48
2:D:35:PHE:HD2	2:D:270:HIS:HD1	1.60	0.48
2:F:19:ASP:OD1	2:F:30:ASN:ND2	2.40	0.48
2:B:109:LEU:HD11	2:H:167:ASN:HA	1.96	0.47
2:F:163:PHE:CE1	2:F:198:PRO:HG3	2.49	0.47
2:H:163:PHE:CE1	2:H:198:PRO:HG3	2.50	0.47
1:E:275:PHE:CE1	1:E:293:THR:HG23	2.50	0.47
2:D:63:LEU:HD12	2:D:69:ILE:HB	1.98	0.46
1:G:59:ASN:HB2	2:H:149:GLN:HG3	1.98	0.46
1:G:39:PHE:CE1	1:G:54:LEU:HD13	2.51	0.46
2:F:62:ASP:OD1	2:F:70:LYS:HE3	2.16	0.46
1:E:175:ASN:ND2	1:E:213:GLN:OE1	2.47	0.45
2:B:35:PHE:CD1	2:B:46:LEU:HD13	2.52	0.45
2:H:62:ASP:OD1	2:H:70:LYS:HE3	2.16	0.45
1:E:39:PHE:CE1	1:E:54:LEU:HD13	2.52	0.44
1:C:28:SER:HB2	1:C:275:PHE:CD1	2.53	0.44
2:F:111:TYR:CE1	2:F:129:PHE:HB2	2.52	0.44
1:E:19:LEU:HD11	1:E:40:ASN:HB3	2.00	0.44
2:F:44:ASP:HB2	2:F:215:HIS:HB3	2.00	0.44
2:D:7:ILE:HG23	2:D:8:GLY:N	2.33	0.44
1:E:158:THR:HG23	1:E:163:VAL:HA	1.99	0.44
2:B:51:GLN:HA	2:B:207:PRO:O	2.18	0.43
2:H:19:ASP:OD1	2:H:30:ASN:ND2	2.44	0.43
1:A:119:PHE:HB3	2:H:129:PHE:CE2	2.52	0.43
2:H:35:PHE:CD1	2:H:46:LEU:HD13	2.54	0.43
1:G:239:LYS:HA	1:G:281:ILE:O	2.19	0.43
1:A:59:ASN:HB2	2:B:149:GLN:HG3	2.01	0.43
1:A:119:PHE:HB3	2:H:129:PHE:HE2	1.84	0.43
2:D:140:LYS:HE3	1:E:108:GLU:OE2	2.19	0.42
1:E:22:THR:HA	2:F:41:TYR:CE1	2.54	0.42
2:H:49:LYS:HD2	2:H:210:ILE:HG12	2.01	0.42
1:A:28:SER:HB2	1:A:275:PHE:CD1	2.54	0.42
1:C:19:LEU:HD23	2:D:40:LYS:HD2	2.02	0.42
1:A:19:LEU:HD11	1:A:40:ASN:HB3	2.01	0.42
1:C:278:THR:HB	1:C:292:ASP:HB2	2.02	0.42
1:E:22:THR:HA	2:F:41:TYR:HE1	1.85	0.42
1:G:158:THR:HG23	1:G:163:VAL:HA	2.01	0.42
1:A:22:THR:HA	2:B:41:TYR:CE1	2.55	0.42
1:C:37:LEU:HB3	1:C:39:PHE:CE2	2.55	0.42
1:G:22:THR:HA	2:H:41:TYR:CE1	2.55	0.42
1:A:158:THR:HG23	1:A:163:VAL:HA	2.02	0.42

Continued on next page...

Continued from previous page...

Atom-1	Atom-2	Interatomic distance (Å)	Clash overlap (Å)
1:A:175:ASN:ND2	1:A:213:GLN:OE1	2.50	0.42
1:A:110:GLN:OE1	1:A:110:GLN:N	2.53	0.42
1:E:99:ASP:OD1	1:E:103:LYS:NZ	2.52	0.41
2:F:63:LEU:HD12	2:F:69:ILE:HB	2.02	0.41
2:B:44:ASP:HB2	2:B:215:HIS:HB3	2.01	0.41
1:C:239:LYS:HA	1:C:281:ILE:O	2.20	0.41
1:A:197:GLY:O	1:A:200:SER:N	2.54	0.41
1:C:99:ASP:OD1	1:C:103:LYS:NZ	2.49	0.41
1:G:235:ASP:OD1	1:G:235:ASP:N	2.50	0.41
2:D:167:ASN:HA	2:F:109:LEU:HD11	2.03	0.41
1:C:273:ARG:CZ	1:C:297:GLU:HG3	2.50	0.41
2:H:35:PHE:HZ	2:H:265:VAL:HG13	1.86	0.41
1:C:158:THR:HG23	1:C:163:VAL:HA	2.01	0.41
1:E:93:ASP:OD1	1:E:161:LYS:NZ	2.54	0.41
1:E:278:THR:HB	1:E:292:ASP:HB2	2.03	0.41
2:H:8:GLY:HA2	2:H:9:GLN:HA	1.92	0.41
2:H:51:GLN:HA	2:H:207:PRO:O	2.21	0.41
2:H:63:LEU:HD12	2:H:69:ILE:HB	2.03	0.41
2:F:221:ASP:OD2	2:F:268:LYS:HE2	2.20	0.40
1:C:167:VAL:HG21	1:C:222:PHE:CZ	2.56	0.40
2:D:51:GLN:HA	2:D:207:PRO:O	2.22	0.40
2:D:111:TYR:CE1	2:D:129:PHE:HB2	2.56	0.40
2:H:44:ASP:HB2	2:H:215:HIS:HB3	2.02	0.40
1:G:37:LEU:HB3	1:G:39:PHE:CE2	2.56	0.40
1:G:28:SER:HB2	1:G:275:PHE:CD1	2.56	0.40

There are no symmetry-related clashes.

5.3 Torsion angles [i](#)

5.3.1 Protein backbone [i](#)

In the following table, the Percentiles column shows the percent Ramachandran outliers of the chain as a percentile score with respect to all X-ray entries followed by that with respect to entries of similar resolution.

The Analysed column shows the number of residues for which the backbone conformation was analysed, and the total number of residues.

Mol	Chain	Analysed	Favoured	Allowed	Outliers	Percentiles
1	A	261/309 (84%)	255 (98%)	6 (2%)	0	100 100

Continued on next page...

Continued from previous page...

Mol	Chain	Analysed	Favoured	Allowed	Outliers	Percentiles	
1	C	260/309 (84%)	252 (97%)	8 (3%)	0	100	100
1	E	259/309 (84%)	252 (97%)	7 (3%)	0	100	100
1	G	260/309 (84%)	254 (98%)	6 (2%)	0	100	100
2	B	260/290 (90%)	252 (97%)	8 (3%)	0	100	100
2	D	260/290 (90%)	252 (97%)	8 (3%)	0	100	100
2	F	260/290 (90%)	251 (96%)	9 (4%)	0	100	100
2	H	260/290 (90%)	254 (98%)	6 (2%)	0	100	100
All	All	2080/2396 (87%)	2022 (97%)	58 (3%)	0	100	100

There are no Ramachandran outliers to report.

5.3.2 Protein sidechains [i](#)

In the following table, the Percentiles column shows the percent sidechain outliers of the chain as a percentile score with respect to all X-ray entries followed by that with respect to entries of similar resolution.

The Analysed column shows the number of residues for which the sidechain conformation was analysed, and the total number of residues.

Mol	Chain	Analysed	Rotameric	Outliers	Percentiles	
1	A	236/269 (88%)	234 (99%)	2 (1%)	81	93
1	C	234/269 (87%)	233 (100%)	1 (0%)	91	97
1	E	234/269 (87%)	232 (99%)	2 (1%)	78	92
1	G	235/269 (87%)	235 (100%)	0	100	100
2	B	237/257 (92%)	233 (98%)	4 (2%)	60	85
2	D	237/257 (92%)	232 (98%)	5 (2%)	53	82
2	F	237/257 (92%)	233 (98%)	4 (2%)	60	85
2	H	237/257 (92%)	234 (99%)	3 (1%)	69	89
All	All	1887/2104 (90%)	1866 (99%)	21 (1%)	73	90

All (21) residues with a non-rotameric sidechain are listed below:

Mol	Chain	Res	Type
1	A	227	LEU
1	A	228	SER

Continued on next page...

Continued from previous page...

Mol	Chain	Res	Type
2	B	6	ASP
2	B	62	ASP
2	B	129	PHE
2	B	149	GLN
1	C	227	LEU
2	D	12	GLU
2	D	62	ASP
2	D	85	LYS
2	D	149	GLN
2	D	259	VAL
1	E	137	THR
1	E	179	PRO
2	F	12	GLU
2	F	13	ILE
2	F	129	PHE
2	F	149	GLN
2	H	129	PHE
2	H	149	GLN
2	H	259	VAL

Sometimes sidechains can be flipped to improve hydrogen bonding and reduce clashes. All (3) such sidechains are listed below:

Mol	Chain	Res	Type
1	C	61	ASN
2	F	138	ASN
2	H	138	ASN

5.3.3 RNA [i](#)

There are no RNA molecules in this entry.

5.4 Non-standard residues in protein, DNA, RNA chains [i](#)

There are no non-standard protein/DNA/RNA residues in this entry.

5.5 Carbohydrates [i](#)

There are no monosaccharides in this entry.

5.6 Ligand geometry [i](#)

There are no ligands in this entry.

5.7 Other polymers [i](#)

There are no such residues in this entry.

5.8 Polymer linkage issues [i](#)

There are no chain breaks in this entry.

6 Fit of model and data

6.1 Protein, DNA and RNA chains

In the following table, the column labelled ‘#RSRZ > 2’ contains the number (and percentage) of RSRZ outliers, followed by percent RSRZ outliers for the chain as percentile scores relative to all X-ray entries and entries of similar resolution. The OWAB column contains the minimum, median, 95th percentile and maximum values of the occupancy-weighted average B-factor per residue. The column labelled ‘Q < 0.9’ lists the number of (and percentage) of residues with an average occupancy less than 0.9.

Mol	Chain	Analysed	<RSRZ>	#RSRZ>2	OWAB(Å ²)	Q<0.9
1	A	267/309 (86%)	0.31	20 (7%) 14 4	16, 45, 103, 138	0
1	C	266/309 (86%)	0.30	17 (6%) 19 6	18, 46, 100, 131	0
1	E	265/309 (85%)	0.27	20 (7%) 14 4	16, 45, 94, 125	0
1	G	266/309 (86%)	0.28	17 (6%) 19 6	18, 45, 100, 133	0
2	B	264/290 (91%)	0.22	16 (6%) 21 7	20, 47, 98, 151	0
2	D	264/290 (91%)	0.16	12 (4%) 33 12	20, 45, 100, 159	0
2	F	264/290 (91%)	0.22	13 (4%) 29 11	22, 46, 94, 159	0
2	H	264/290 (91%)	0.17	9 (3%) 45 19	18, 45, 95, 160	0
All	All	2120/2396 (88%)	0.24	124 (5%) 23 7	16, 46, 100, 160	0

All (124) RSRZ outliers are listed below:

Mol	Chain	Res	Type	RSRZ
1	A	201	SER	5.8
2	F	243	HIS	5.3
1	E	257	TRP	5.3
1	G	257	TRP	4.8
1	C	198	ALA	4.7
1	A	257	TRP	4.7
2	H	243	HIS	4.6
1	G	201	SER	4.6
1	C	257	TRP	4.4
2	D	243	HIS	4.3
1	E	72	TYR	4.2
2	B	243	HIS	3.9
1	E	261	TYR	3.9
1	C	203	TYR	3.8
2	D	129	PHE	3.8
1	A	261	TYR	3.8

Continued on next page...

Continued from previous page...

Mol	Chain	Res	Type	RSRZ
1	A	72	TYR	3.7
1	C	262	TRP	3.7
2	B	67	PRO	3.6
2	B	129	PHE	3.6
1	G	261	TYR	3.6
1	G	203	TYR	3.5
1	G	70	ASN	3.5
1	E	73	ASP	3.4
2	F	239	TYR	3.4
1	C	73	ASP	3.4
1	G	258	ASN	3.4
1	C	72	TYR	3.3
1	E	70	ASN	3.3
2	F	67	PRO	3.3
1	C	70	ASN	3.3
1	E	203	TYR	3.3
1	G	262	TRP	3.2
1	G	72	TYR	3.2
1	A	73	ASP	3.1
1	C	205	GLY	3.1
1	C	206	GLN	3.1
1	G	259	GLY	3.0
1	A	203	TYR	3.0
1	G	260	PHE	3.0
1	E	119	PHE	2.9
2	D	187	ALA	2.9
2	B	239	TYR	2.9
1	E	262	TRP	2.8
1	E	258	ASN	2.8
1	A	119	PHE	2.8
1	A	70	ASN	2.8
1	G	73	ASP	2.7
1	E	205	GLY	2.7
1	A	206	GLN	2.7
1	A	256	CYS	2.7
1	A	260	PHE	2.7
1	A	117	TYR	2.7
2	F	242	ARG	2.7
1	A	262	TRP	2.7
2	B	11	ALA	2.7
2	F	111	TYR	2.6
1	G	117	TYR	2.6

Continued on next page...

Continued from previous page...

Mol	Chain	Res	Type	RSRZ
1	E	260	PHE	2.6
1	A	189	TYR	2.6
1	C	187	PRO	2.6
1	G	119	PHE	2.6
1	C	197	GLY	2.5
1	G	204	ALA	2.5
2	B	245	LEU	2.5
2	B	7	ILE	2.5
2	F	126	SER	2.5
1	A	205	GLY	2.5
2	D	126	SER	2.5
1	A	259	GLY	2.5
2	F	7	ILE	2.5
1	A	200	SER	2.5
2	D	67	PRO	2.4
2	F	114	GLY	2.4
1	C	261	TYR	2.4
1	E	120	GLY	2.4
1	A	118	THR	2.4
1	E	204	ALA	2.4
2	F	11	ALA	2.4
1	E	71	ASP	2.4
2	D	111	TYR	2.4
2	H	239	TYR	2.4
2	H	126	SER	2.4
1	C	74	PHE	2.4
2	B	114	GLY	2.3
1	E	189	TYR	2.3
1	C	204	ALA	2.3
2	B	113	ILE	2.3
1	E	197	GLY	2.3
2	F	129	PHE	2.3
2	B	185	PRO	2.3
2	B	240	VAL	2.3
2	H	187	ALA	2.3
2	B	242	ARG	2.3
1	C	259	GLY	2.3
1	C	119	PHE	2.3
2	D	241	THR	2.2
1	A	71	ASP	2.2
2	D	239	TYR	2.2
1	E	187	PRO	2.2

Continued on next page...

Continued from previous page...

Mol	Chain	Res	Type	RSRZ
2	H	242	ARG	2.2
1	G	205	GLY	2.2
2	F	241	THR	2.2
1	G	74	PHE	2.2
1	C	90	GLN	2.2
2	B	111	TYR	2.2
1	A	258	ASN	2.2
2	B	130	ASN	2.2
2	D	64	LYS	2.2
2	F	113	ILE	2.2
2	H	129	PHE	2.1
2	D	11	ALA	2.1
1	E	259	GLY	2.1
2	B	109	LEU	2.1
1	E	206	GLN	2.1
2	F	69	ILE	2.1
1	E	74	PHE	2.1
2	H	11	ALA	2.1
2	H	130	ASN	2.0
2	B	246	ALA	2.0
1	G	270	PHE	2.0
2	D	242	ARG	2.0
2	D	7	ILE	2.0
2	H	7	ILE	2.0

6.2 Non-standard residues in protein, DNA, RNA chains [i](#)

There are no non-standard protein/DNA/RNA residues in this entry.

6.3 Carbohydrates [i](#)

There are no monosaccharides in this entry.

6.4 Ligands [i](#)

There are no ligands in this entry.

6.5 Other polymers [i](#)

There are no such residues in this entry.