



# Full wwPDB X-ray Structure Validation Report ⓘ

Jun 19, 2024 – 10:09 AM EDT

PDB ID : 3WQP  
Title : Crystal structure of Rubisco T289D mutant from *Thermococcus kodakarensis*  
Authors : Fujihashi, M.; Nishitani, Y.; Kiriyaama, T.; Miki, K.  
Deposited on : 2014-01-29  
Resolution : 2.25 Å(reported)

This is a Full wwPDB X-ray Structure Validation Report for a publicly released PDB entry.

We welcome your comments at [validation@mail.wwpdb.org](mailto:validation@mail.wwpdb.org)

A user guide is available at

<https://www.wwpdb.org/validation/2017/XrayValidationReportHelp>

with specific help available everywhere you see the ⓘ symbol.

The types of validation reports are described at

<http://www.wwpdb.org/validation/2017/FAQs#types>.

---

The following versions of software and data (see [references ⓘ](#)) were used in the production of this report:

MolProbity : 4.02b-467  
Mogul : 2022.3.0, CSD as543be (2022)  
Xtriage (Phenix) : 1.20.1  
EDS : 2.37.1  
buster-report : 1.1.7 (2018)  
Percentile statistics : 20191225.v01 (using entries in the PDB archive December 25th 2019)  
Refmac : 5.8.0158  
CCP4 : 7.0.044 (Gargrove)  
Ideal geometry (proteins) : Engh & Huber (2001)  
Ideal geometry (DNA, RNA) : Parkinson et al. (1996)  
Validation Pipeline (wwPDB-VP) : 2.37.1

# 1 Overall quality at a glance

The following experimental techniques were used to determine the structure:

*X-RAY DIFFRACTION*

The reported resolution of this entry is 2.25 Å.

Percentile scores (ranging between 0-100) for global validation metrics of the entry are shown in the following graphic. The table shows the number of entries on which the scores are based.

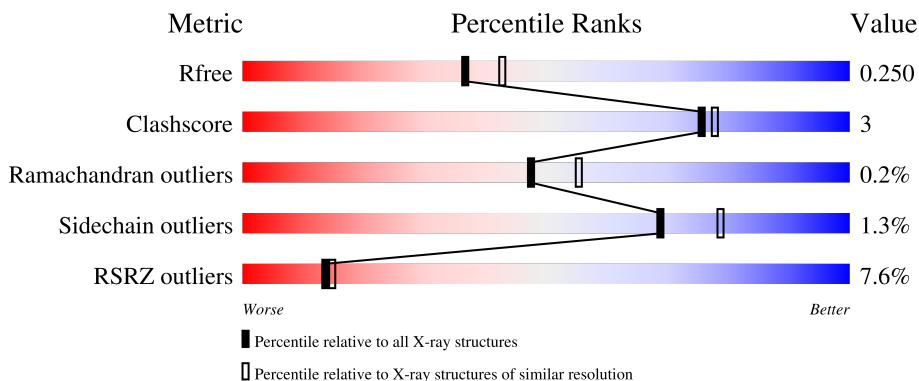

Metric	Whole archive (#Entries)	Similar resolution (#Entries, resolution range(Å))
$R_{free}$	130704	1377 (2.26-2.26)
Clashscore	141614	1487 (2.26-2.26)
Ramachandran outliers	138981	1449 (2.26-2.26)
Sidechain outliers	138945	1450 (2.26-2.26)
RSRZ outliers	127900	1356 (2.26-2.26)

The table below summarises the geometric issues observed across the polymeric chains and their fit to the electron density. The red, orange, yellow and green segments of the lower bar indicate the fraction of residues that contain outliers for  $\geq 3$ , 2, 1 and 0 types of geometric quality criteria respectively. A grey segment represents the fraction of residues that are not modelled. The numeric value for each fraction is indicated below the corresponding segment, with a dot representing fractions  $\leq 5\%$ . The upper red bar (where present) indicates the fraction of residues that have poor fit to the electron density. The numeric value is given above the bar.

Mol	Chain	Length	Quality of chain
1	A	444	
1	B	444	
1	C	444	
1	D	444	
1	E	444	

Continued on next page...

*Continued from previous page...*

Mol	Chain	Length	Quality of chain
1	F	444	
1	G	444	
1	H	444	
1	I	444	
1	J	444	

## 2 Entry composition [i](#)

There are 5 unique types of molecules in this entry. The entry contains 36577 atoms, of which 0 are hydrogens and 0 are deuteriums.

In the tables below, the ZeroOcc column contains the number of atoms modelled with zero occupancy, the AltConf column contains the number of residues with at least one atom in alternate conformation and the Trace column contains the number of residues modelled with at most 2 atoms.

- Molecule 1 is a protein called Ribulose biphosphate carboxylase.

Mol	Chain	Residues	Atoms					ZeroOcc	AltConf	Trace
			Total	C	N	O	S			
1	A	437	Total 3425	C 2200	N 584	O 631	S 10	0	0	0
1	B	438	Total 3440	C 2207	N 587	O 636	S 10	0	0	0
1	C	438	Total 3443	C 2209	N 588	O 636	S 10	0	0	0
1	D	436	Total 3441	C 2209	N 587	O 635	S 10	0	0	0
1	E	438	Total 3438	C 2206	N 586	O 636	S 10	0	0	0
1	F	436	Total 3408	C 2185	N 584	O 629	S 10	0	0	0
1	G	436	Total 3416	C 2192	N 581	O 633	S 10	0	0	0
1	H	437	Total 3423	C 2200	N 586	O 627	S 10	0	0	0
1	I	436	Total 3434	C 2204	N 587	O 633	S 10	0	0	0
1	J	437	Total 3438	C 2209	N 586	O 633	S 10	0	0	0

There are 10 discrepancies between the modelled and reference sequences:

Chain	Residue	Modelled	Actual	Comment	Reference
A	289	ASP	THR	engineered mutation	UNP O93627
B	289	ASP	THR	engineered mutation	UNP O93627
C	289	ASP	THR	engineered mutation	UNP O93627
D	289	ASP	THR	engineered mutation	UNP O93627
E	289	ASP	THR	engineered mutation	UNP O93627
F	289	ASP	THR	engineered mutation	UNP O93627
G	289	ASP	THR	engineered mutation	UNP O93627
H	289	ASP	THR	engineered mutation	UNP O93627
I	289	ASP	THR	engineered mutation	UNP O93627

*Continued on next page...*

*Continued from previous page...*

Chain	Residue	Modelled	Actual	Comment	Reference
J	289	ASP	THR	engineered mutation	UNP O93627

- Molecule 2 is MAGNESIUM ION (three-letter code: MG) (formula: Mg).

Mol	Chain	Residues	Atoms	ZeroOcc	AltConf
2	A	1	Total Mg 1 1	0	0
2	B	1	Total Mg 1 1	0	0
2	C	1	Total Mg 1 1	0	0
2	D	1	Total Mg 1 1	0	0
2	E	1	Total Mg 1 1	0	0
2	F	1	Total Mg 1 1	0	0
2	G	1	Total Mg 1 1	0	0
2	H	1	Total Mg 1 1	0	0
2	I	1	Total Mg 1 1	0	0
2	J	1	Total Mg 1 1	0	0

- Molecule 3 is 2-CARBOXYARABINITOL-1,5-DIPHOSPHATE (three-letter code: CAP) (formula: C<sub>6</sub>H<sub>14</sub>O<sub>13</sub>P<sub>2</sub>).

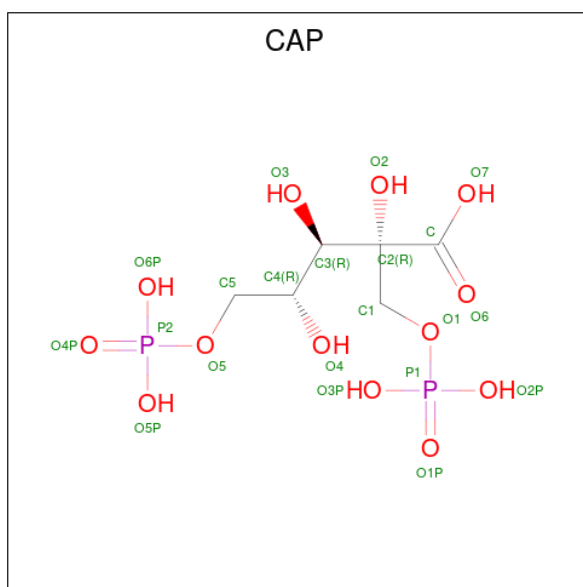

Mol	Chain	Residues	Atoms				ZeroOcc	AltConf
3	A	1	Total	C	O	P	0	0
			21	6	13	2		
3	B	1	Total	C	O	P	0	0
			21	6	13	2		
3	C	1	Total	C	O	P	0	0
			21	6	13	2		
3	D	1	Total	C	O	P	0	0
			21	6	13	2		
3	E	1	Total	C	O	P	0	0
			21	6	13	2		
3	F	1	Total	C	O	P	0	0
			21	6	13	2		
3	G	1	Total	C	O	P	0	0
			21	6	13	2		
3	H	1	Total	C	O	P	0	0
			21	6	13	2		
3	I	1	Total	C	O	P	0	0
			21	6	13	2		
3	J	1	Total	C	O	P	0	0
			21	6	13	2		

- Molecule 4 is 1,2-ETHANEDIOL (three-letter code: EDO) (formula:  $C_2H_6O_2$ ).



Mol	Chain	Residues	Atoms	ZeroOcc	AltConf
4	A	1	Total C O 4 2 2	0	0
4	B	1	Total C O 4 2 2	0	0
4	C	1	Total C O 4 2 2	0	0
4	D	1	Total C O 4 2 2	0	0
4	E	1	Total C O 4 2 2	0	0
4	H	1	Total C O 4 2 2	0	0
4	H	1	Total C O 4 2 2	0	0
4	I	1	Total C O 4 2 2	0	0
4	I	1	Total C O 4 2 2	0	0
4	J	1	Total C O 4 2 2	0	0

- Molecule 5 is water.

Mol	Chain	Residues	Atoms	ZeroOcc	AltConf
5	A	183	Total O 183 183	0	0
5	B	127	Total O 127 127	0	0

*Continued on next page...*

*Continued from previous page...*

Mol	Chain	Residues	Atoms		ZeroOcc	AltConf
5	C	223	Total 223	O 223	0	0
5	D	240	Total 240	O 240	0	0
5	E	252	Total 252	O 252	0	0
5	F	170	Total 170	O 170	0	0
5	G	133	Total 133	O 133	0	0
5	H	184	Total 184	O 184	0	0
5	I	244	Total 244	O 244	0	0
5	J	255	Total 255	O 255	0	0



### 3 Residue-property plots [i](#)

These plots are drawn for all protein, RNA, DNA and oligosaccharide chains in the entry. The first graphic for a chain summarises the proportions of the various outlier classes displayed in the second graphic. The second graphic shows the sequence view annotated by issues in geometry and electron density. Residues are color-coded according to the number of geometric quality criteria for which they contain at least one outlier: green = 0, yellow = 1, orange = 2 and red = 3 or more. A red dot above a residue indicates a poor fit to the electron density ( $RSRZ > 2$ ). Stretches of 2 or more consecutive residues without any outlier are shown as a green connector. Residues present in the sample, but not in the model, are shown in grey.

- Molecule 1: Ribulose biphosphate carboxylase

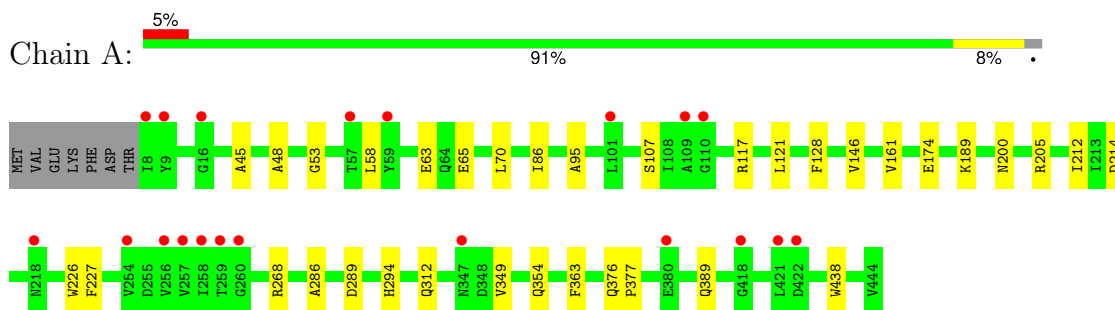

- Molecule 1: Ribulose biphosphate carboxylase

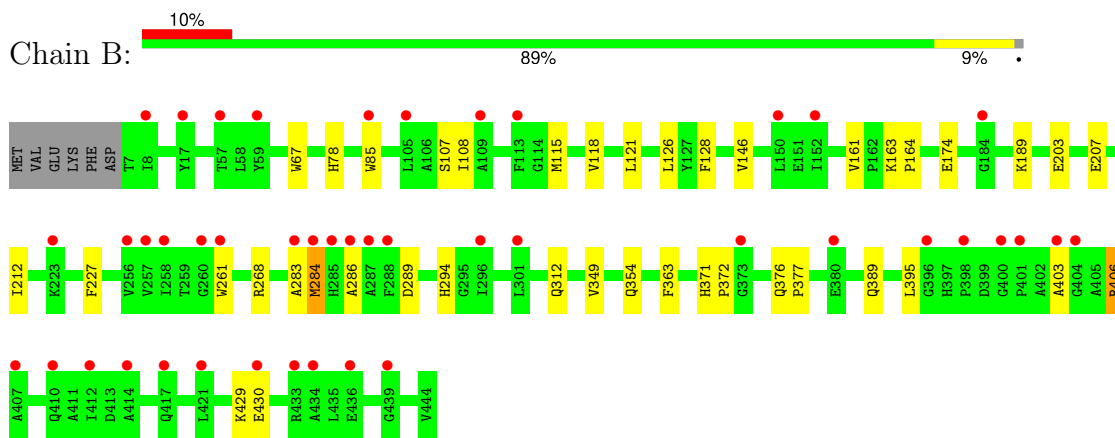

- Molecule 1: Ribulose biphosphate carboxylase

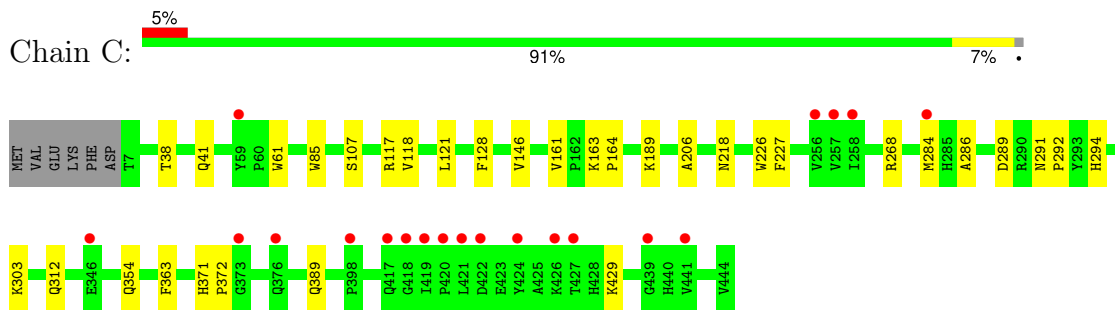

- Molecule 1: Ribulose biphosphate carboxylase

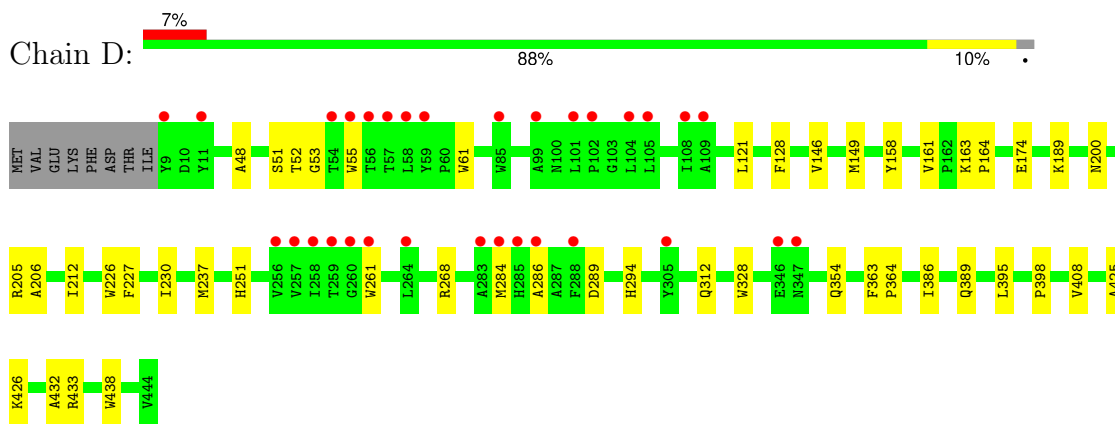

- Molecule 1: Ribulose biphosphate carboxylase

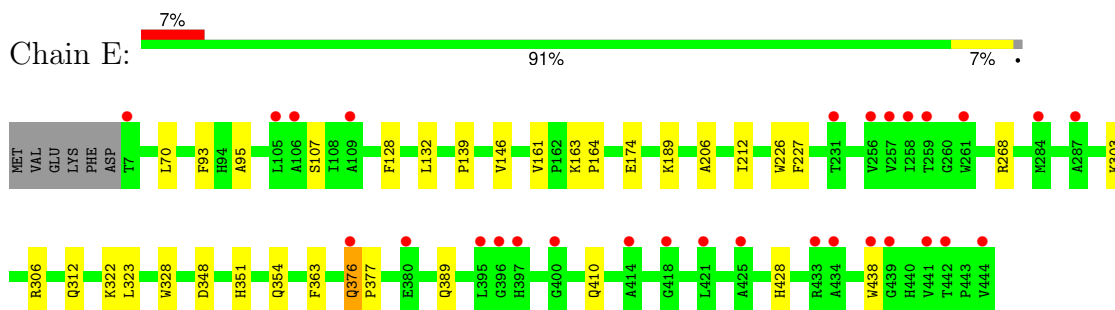

- Molecule 1: Ribulose biphosphate carboxylase

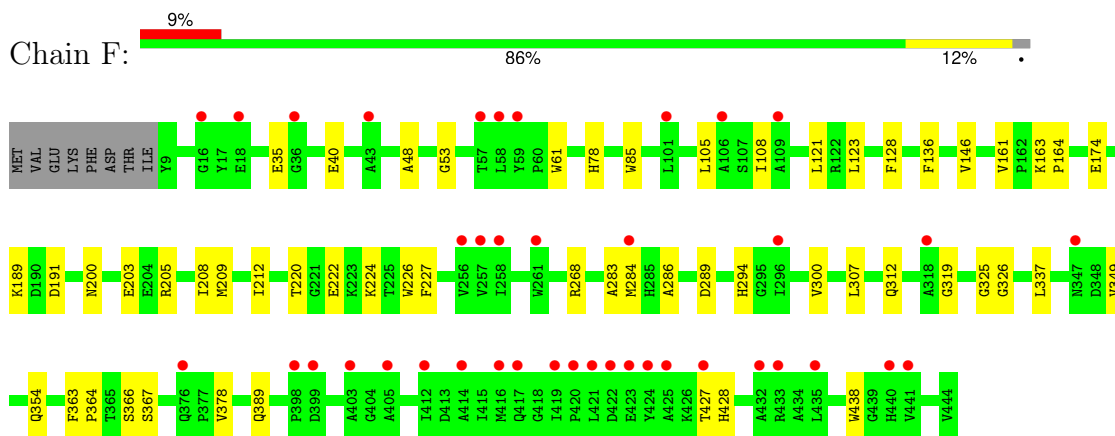

- Molecule 1: Ribulose biphosphate carboxylase

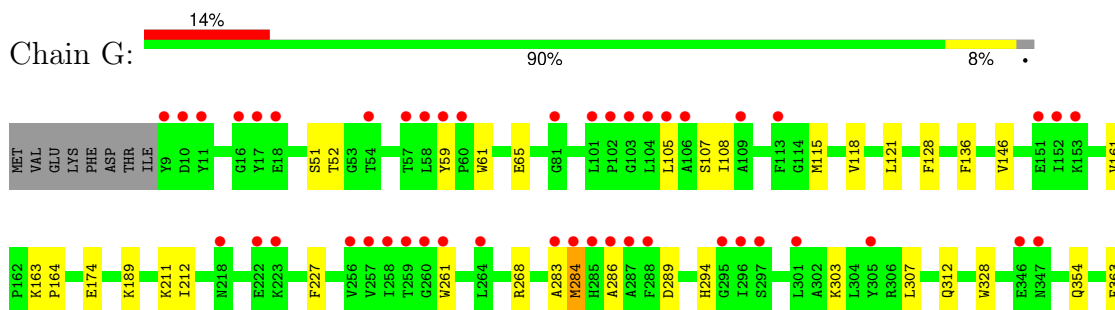

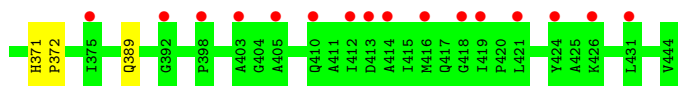

- Molecule 1: Ribulose biphosphate carboxylase

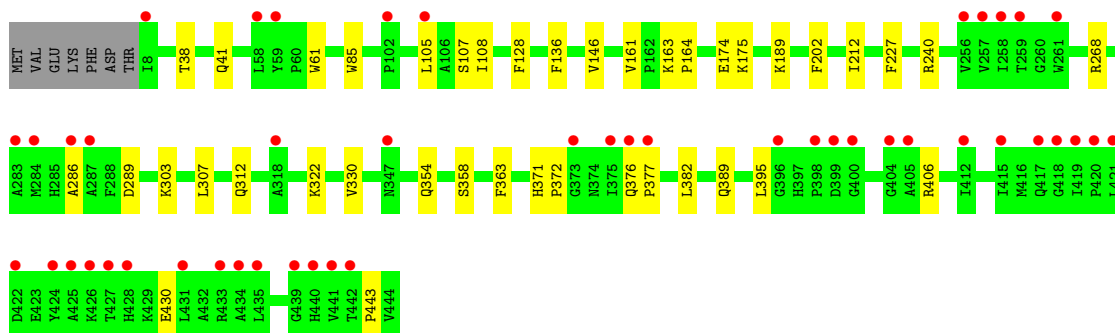
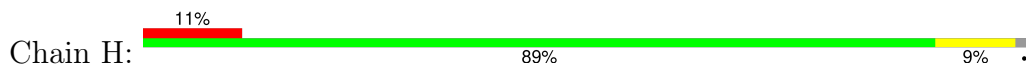

- Molecule 1: Ribulose biphosphate carboxylase

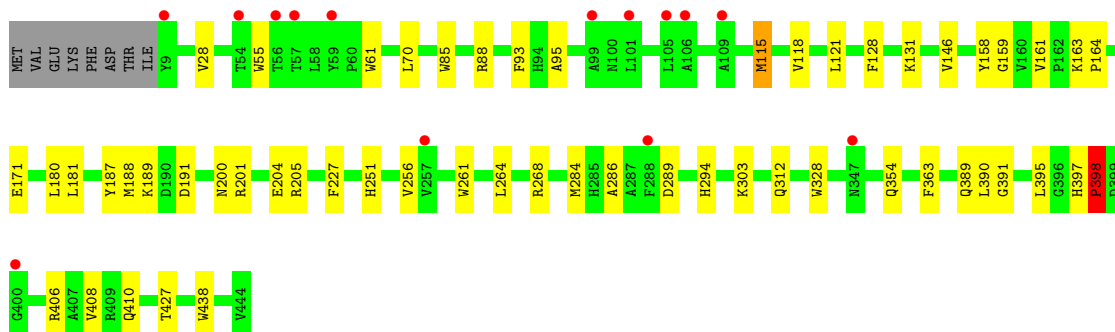
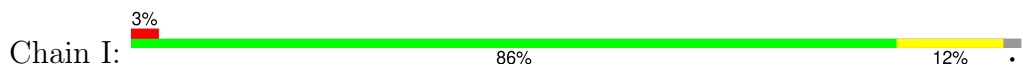

- Molecule 1: Ribulose biphosphate carboxylase

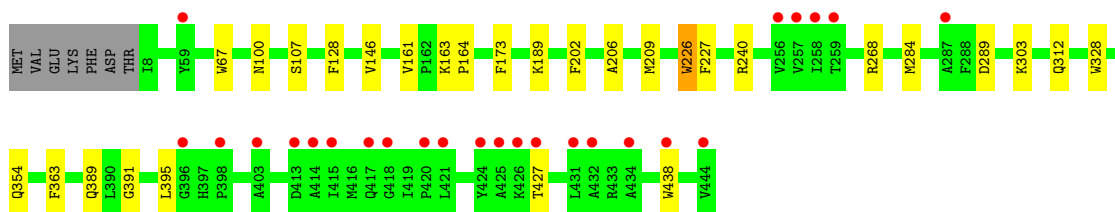
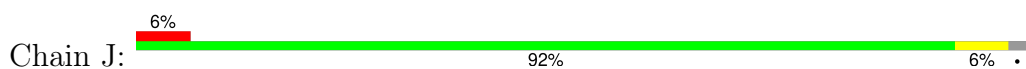

## 4 Data and refinement statistics

Property	Value	Source
Space group	P 21 21 2	Depositor
Cell constants a, b, c, $\alpha$ , $\beta$ , $\gamma$	170.57Å 246.24Å 144.63Å 90.00° 90.00° 90.00°	Depositor
Resolution (Å)	50.00 – 2.25 47.18 – 2.25	Depositor EDS
% Data completeness (in resolution range)	99.6 (50.00-2.25) 99.7 (47.18-2.25)	Depositor EDS
$R_{merge}$	(Not available)	Depositor
$R_{sym}$	0.09	Depositor
$\langle I/\sigma(I) \rangle$ <sup>1</sup>	2.25 (at 2.24Å)	Xtrriage
Refinement program	REFMAC 5.6.0117	Depositor
R, $R_{free}$	0.220 , 0.258 0.215 , 0.250	Depositor DCC
$R_{free}$ test set	14396 reflections (5.03%)	wwPDB-VP
Wilson B-factor (Å <sup>2</sup> )	33.8	Xtrriage
Anisotropy	1.150	Xtrriage
Bulk solvent $k_{sol}$ (e/Å <sup>3</sup> ), $B_{sol}$ (Å <sup>2</sup> )	0.34 , 45.5	EDS
L-test for twinning <sup>2</sup>	$\langle  L  \rangle = 0.53$ , $\langle L^2 \rangle = 0.37$	Xtrriage
Estimated twinning fraction	No twinning to report.	Xtrriage
$F_o, F_c$ correlation	0.96	EDS
Total number of atoms	36577	wwPDB-VP
Average B, all atoms (Å <sup>2</sup> )	51.0	wwPDB-VP

Xtrriage's analysis on translational NCS is as follows: *The analyses of the Patterson function reveals a significant off-origin peak that is 48.73 % of the origin peak, indicating pseudo-translational symmetry. The chance of finding a peak of this or larger height randomly in a structure without pseudo-translational symmetry is equal to 8.2523e-05. The detected translational NCS is most likely also responsible for the elevated intensity ratio.*

<sup>1</sup>Intensities estimated from amplitudes.

<sup>2</sup>Theoretical values of  $\langle |L| \rangle$ ,  $\langle L^2 \rangle$  for acentric reflections are 0.5, 0.333 respectively for untwinned datasets, and 0.375, 0.2 for perfectly twinned datasets.

## 5 Model quality [i](#)

### 5.1 Standard geometry [i](#)

Bond lengths and bond angles in the following residue types are not validated in this section: EDO, CAP, KCX, MG

The Z score for a bond length (or angle) is the number of standard deviations the observed value is removed from the expected value. A bond length (or angle) with  $|Z| > 5$  is considered an outlier worth inspection. RMSZ is the root-mean-square of all Z scores of the bond lengths (or angles).

Mol	Chain	Bond lengths		Bond angles	
		RMSZ	# Z  >5	RMSZ	# Z  >5
1	A	0.48	2/3502 (0.1%)	0.51	0/4753
1	B	0.48	3/3517 (0.1%)	0.50	0/4770
1	C	0.48	2/3520 (0.1%)	0.51	0/4773
1	D	0.50	5/3517 (0.1%)	0.52	0/4766
1	E	0.50	2/3515 (0.1%)	0.52	0/4767
1	F	0.49	4/3483 (0.1%)	0.51	0/4724
1	G	0.48	3/3493 (0.1%)	0.49	0/4742
1	H	0.48	2/3500 (0.1%)	0.49	0/4748
1	I	0.50	6/3510 (0.2%)	0.53	0/4757
1	J	0.50	4/3515 (0.1%)	0.52	0/4766
All	All	0.49	33/35072 (0.1%)	0.51	0/47566

All (33) bond length outliers are listed below:

Mol	Chain	Res	Type	Atoms	Z	Observed(Å)	Ideal(Å)
1	D	438	TRP	CD2-CE2	5.26	1.47	1.41
1	I	438	TRP	CD2-CE2	5.19	1.47	1.41
1	F	438	TRP	CD2-CE2	5.18	1.47	1.41
1	F	226	TRP	CD2-CE2	5.18	1.47	1.41
1	C	61	TRP	CD2-CE2	5.17	1.47	1.41
1	I	261	TRP	CD2-CE2	5.17	1.47	1.41
1	A	438	TRP	CD2-CE2	5.14	1.47	1.41
1	D	328	TRP	CD2-CE2	5.12	1.47	1.41
1	E	438	TRP	CD2-CE2	5.11	1.47	1.41
1	J	438	TRP	CD2-CE2	5.08	1.47	1.41
1	I	328	TRP	CD2-CE2	5.08	1.47	1.41
1	D	261	TRP	CD2-CE2	5.08	1.47	1.41
1	F	85	TRP	CD2-CE2	5.08	1.47	1.41
1	J	226	TRP	CD2-CE2	5.08	1.47	1.41
1	D	55	TRP	CD2-CE2	5.05	1.47	1.41
1	A	226	TRP	CD2-CE2	5.05	1.47	1.41

*Continued on next page...*

Continued from previous page...

Mol	Chain	Res	Type	Atoms	Z	Observed(Å)	Ideal(Å)
1	B	67	TRP	CD2-CE2	5.05	1.47	1.41
1	I	61	TRP	CD2-CE2	5.04	1.47	1.41
1	F	61	TRP	CD2-CE2	5.03	1.47	1.41
1	I	85	TRP	CD2-CE2	5.03	1.47	1.41
1	H	85	TRP	CD2-CE2	5.03	1.47	1.41
1	E	328	TRP	CD2-CE2	5.03	1.47	1.41
1	H	61	TRP	CD2-CE2	5.03	1.47	1.41
1	D	61	TRP	CD2-CE2	5.01	1.47	1.41
1	G	328	TRP	CD2-CE2	5.01	1.47	1.41
1	B	261	TRP	CD2-CE2	5.01	1.47	1.41
1	I	55	TRP	CD2-CE2	5.01	1.47	1.41
1	J	67	TRP	CD2-CE2	5.01	1.47	1.41
1	G	261	TRP	CD2-CE2	5.01	1.47	1.41
1	J	328	TRP	CD2-CE2	5.01	1.47	1.41
1	B	85	TRP	CD2-CE2	5.00	1.47	1.41
1	C	85	TRP	CD2-CE2	5.00	1.47	1.41
1	G	61	TRP	CD2-CE2	5.00	1.47	1.41

There are no bond angle outliers.

There are no chirality outliers.

There are no planarity outliers.

## 5.2 Too-close contacts [i](#)

In the following table, the Non-H and H(model) columns list the number of non-hydrogen atoms and hydrogen atoms in the chain respectively. The H(added) column lists the number of hydrogen atoms added and optimized by MolProbity. The Clashes column lists the number of clashes within the asymmetric unit, whereas Symm-Clashes lists symmetry-related clashes.

Mol	Chain	Non-H	H(model)	H(added)	Clashes	Symm-Clashes
1	A	3425	0	3321	16	0
1	B	3440	0	3335	25	0
1	C	3443	0	3344	17	0
1	D	3441	0	3368	22	0
1	E	3438	0	3328	17	0
1	F	3408	0	3301	31	0
1	G	3416	0	3299	18	0
1	H	3423	0	3328	21	0
1	I	3434	0	3355	35	0
1	J	3438	0	3346	12	0
2	A	1	0	0	0	0

Continued on next page...

*Continued from previous page...*

Mol	Chain	Non-H	H(model)	H(added)	Clashes	Symm-Clashes
2	B	1	0	0	0	0
2	C	1	0	0	0	0
2	D	1	0	0	0	0
2	E	1	0	0	0	0
2	F	1	0	0	0	0
2	G	1	0	0	0	0
2	H	1	0	0	0	0
2	I	1	0	0	0	0
2	J	1	0	0	0	0
3	A	21	0	8	0	0
3	B	21	0	9	0	0
3	C	21	0	9	0	0
3	D	21	0	8	0	0
3	E	21	0	9	0	0
3	F	21	0	9	1	0
3	G	21	0	8	0	0
3	H	21	0	9	1	0
3	I	21	0	7	0	0
3	J	21	0	9	0	0
4	A	4	0	6	1	0
4	B	4	0	6	0	0
4	C	4	0	6	0	0
4	D	4	0	6	0	0
4	E	4	0	6	0	0
4	H	8	0	12	0	0
4	I	8	0	12	0	0
4	J	4	0	6	1	0
5	A	183	0	0	0	0
5	B	127	0	0	0	0
5	C	223	0	0	2	0
5	D	240	0	0	0	0
5	E	252	0	0	1	0
5	F	170	0	0	3	0
5	G	133	0	0	1	0
5	H	184	0	0	0	0
5	I	244	0	0	2	0
5	J	255	0	0	0	0
All	All	36577	0	33470	212	0

The all-atom clashscore is defined as the number of clashes found per 1000 atoms (including hydrogen atoms). The all-atom clashscore for this structure is 3.

All (212) close contacts within the same asymmetric unit are listed below, sorted by their clash magnitude.

Atom-1	Atom-2	Interatomic distance (Å)	Clash overlap (Å)
1:B:406:ARG:HG2	1:B:406:ARG:HH11	1.06	1.06
1:F:174:GLU:HG3	1:F:212:ILE:HD11	1.52	0.90
1:B:108:ILE:HD12	1:B:126:LEU:HD11	1.52	0.90
1:A:128:PHE:H	1:A:354:GLN:HE22	1.24	0.86
1:B:406:ARG:HG2	1:B:406:ARG:NH1	1.86	0.86
1:C:38:THR:H	1:C:41:GLN:HE21	1.30	0.80
1:C:128:PHE:H	1:C:354:GLN:HE22	1.30	0.78
1:J:128:PHE:H	1:J:354:GLN:HE22	1.32	0.76
1:B:174:GLU:HG3	1:B:212:ILE:HD11	1.68	0.75
1:B:128:PHE:H	1:B:354:GLN:HE22	1.36	0.73
1:A:174:GLU:HG3	1:A:212:ILE:HD11	1.69	0.72
1:H:128:PHE:H	1:H:354:GLN:HE22	1.39	0.71
1:B:403:ALA:HA	1:B:406:ARG:CD	2.21	0.70
1:I:115:MET:HB2	1:I:118:VAL:HG22	1.74	0.69
1:D:128:PHE:H	1:D:354:GLN:HE22	1.38	0.68
1:C:121:LEU:H	1:C:294:HIS:HD2	1.41	0.68
1:I:161:VAL:H	1:I:389:GLN:NE2	1.90	0.68
1:E:189:KCX:HG2	1:E:227:PHE:HB2	1.76	0.68
1:G:174:GLU:HG3	1:G:212:ILE:HD11	1.75	0.68
1:H:38:THR:H	1:H:41:GLN:HE21	1.42	0.67
1:G:128:PHE:H	1:G:354:GLN:HE22	1.42	0.67
1:I:128:PHE:H	1:I:354:GLN:HE22	1.40	0.67
1:D:174:GLU:HG3	1:D:212:ILE:HD11	1.77	0.66
1:E:128:PHE:H	1:E:354:GLN:HE22	1.45	0.65
1:I:161:VAL:H	1:I:389:GLN:HE21	1.46	0.64
1:I:191:ASP:HB2	5:I:658:HOH:O	1.97	0.64
1:B:403:ALA:HA	1:B:406:ARG:HD2	1.81	0.63
1:F:128:PHE:H	1:F:354:GLN:HE22	1.44	0.63
1:D:121:LEU:H	1:D:294:HIS:HD2	1.47	0.63
1:D:163:LYS:H	1:D:395:LEU:HD22	1.64	0.62
1:B:403:ALA:HA	1:B:406:ARG:HD3	1.82	0.62
1:A:161:VAL:H	1:A:389:GLN:NE2	1.98	0.61
1:I:389:GLN:C	1:I:390:LEU:HD12	2.20	0.61
1:F:78:HIS:CD2	1:F:349:VAL:HG21	2.36	0.61
1:F:121:LEU:H	1:F:294:HIS:HD2	1.49	0.60
1:A:48:ALA:HB1	1:A:53:GLY:HA3	1.83	0.60
1:H:174:GLU:HG3	1:H:212:ILE:HD11	1.84	0.60
1:H:189:KCX:HG2	1:H:227:PHE:HB2	1.84	0.60
1:G:115:MET:HB2	1:G:118:VAL:HG22	1.84	0.60
1:F:209:MET:HE2	1:F:209:MET:HA	1.84	0.59
1:I:406:ARG:O	1:I:410:GLN:HG3	2.02	0.59
1:F:222:GLU:HG3	1:F:224:LYS:HE2	1.84	0.59

*Continued on next page...*



*Continued from previous page...*

Atom-1	Atom-2	Interatomic distance (Å)	Clash overlap (Å)
1:F:161:VAL:H	1:F:389:GLN:NE2	1.99	0.59
1:C:121:LEU:H	1:C:294:HIS:CD2	2.20	0.59
1:H:406:ARG:HH11	1:H:430:GLU:HG2	1.67	0.58
1:F:337:LEU:HD22	1:F:364:PRO:HG3	1.85	0.58
1:G:189:KCX:HG2	1:G:227:PHE:HB2	1.84	0.58
1:G:65:GLU:HB2	5:G:689:HOH:O	2.04	0.58
1:C:38:THR:H	1:C:41:GLN:NE2	2.02	0.57
1:F:189:KCX:HG2	1:F:227:PHE:HB2	1.86	0.57
1:B:189:KCX:HG2	1:B:227:PHE:HB2	1.86	0.57
1:F:146:VAL:HG21	1:F:312:GLN:HE21	1.69	0.56
1:F:121:LEU:H	1:F:294:HIS:CD2	2.24	0.55
1:I:146:VAL:HG21	1:I:312:GLN:HE21	1.70	0.55
1:D:161:VAL:H	1:D:389:GLN:NE2	2.04	0.55
1:B:406:ARG:HH11	1:B:406:ARG:CG	1.97	0.55
1:A:121:LEU:H	1:A:294:HIS:HD2	1.54	0.54
1:A:189:KCX:HG2	1:A:227:PHE:HB2	1.89	0.54
1:G:161:VAL:H	1:G:389:GLN:NE2	2.06	0.54
1:A:121:LEU:H	1:A:294:HIS:CD2	2.25	0.54
1:I:121:LEU:H	1:I:294:HIS:HD2	1.55	0.54
1:B:146:VAL:HG21	1:B:312:GLN:HE21	1.72	0.53
1:B:121:LEU:H	1:B:294:HIS:HD2	1.55	0.53
1:E:410:GLN:NE2	1:E:428:HIS:HB3	2.23	0.53
1:G:163:LYS:HA	1:G:164:PRO:C	2.29	0.53
1:I:389:GLN:O	1:I:390:LEU:HD12	2.09	0.53
1:J:161:VAL:H	1:J:389:GLN:NE2	2.07	0.53
1:F:209:MET:HA	1:F:209:MET:CE	2.39	0.52
1:F:367:SER:HB2	1:F:389:GLN:HB3	1.91	0.52
1:C:161:VAL:H	1:C:389:GLN:NE2	2.08	0.52
1:E:376:GLN:HG3	1:E:377:PRO:HD3	1.91	0.52
1:J:202:PHE:CD2	1:J:240:ARG:HG2	2.44	0.52
1:G:105:LEU:HD23	1:G:108:ILE:HD11	1.90	0.52
1:H:406:ARG:NH1	1:H:430:GLU:HG2	2.25	0.52
1:H:330:VAL:HG12	1:H:382:LEU:HD21	1.92	0.51
1:F:161:VAL:H	1:F:389:GLN:HE21	1.58	0.51
1:D:121:LEU:H	1:D:294:HIS:CD2	2.25	0.51
1:I:303:LYS:HZ3	1:I:354:GLN:HE21	1.58	0.51
1:F:286:ALA:HA	1:F:289:ASP:OD1	2.11	0.51
1:A:146:VAL:HG21	1:A:312:GLN:HE21	1.75	0.51
1:F:48:ALA:HB1	1:F:53:GLY:HA3	1.92	0.51
1:I:159:GLY:HA3	1:I:187:TYR:CZ	2.45	0.51
1:I:201:ARG:HB2	1:I:204:GLU:HG3	1.93	0.51

*Continued on next page...*

*Continued from previous page...*

Atom-1	Atom-2	Interatomic distance (Å)	Clash overlap (Å)
1:I:286:ALA:HA	1:I:289:ASP:OD1	2.10	0.51
1:I:303:LYS:NZ	1:I:354:GLN:HE21	2.09	0.51
1:C:118:VAL:HG11	1:C:121:LEU:HB2	1.93	0.51
1:I:189:KCX:HG2	1:I:227:PHE:HB2	1.94	0.50
1:D:163:LYS:HA	1:D:164:PRO:C	2.32	0.50
1:F:203:GLU:HB2	5:F:624:HOH:O	2.10	0.50
1:H:161:VAL:H	1:H:389:GLN:NE2	2.09	0.50
1:E:146:VAL:HG21	1:E:312:GLN:HE21	1.77	0.50
1:I:161:VAL:N	1:I:389:GLN:HE21	2.10	0.49
1:B:163:LYS:H	1:B:395:LEU:HD22	1.77	0.49
1:G:121:LEU:H	1:G:294:HIS:CD2	2.30	0.49
1:C:146:VAL:HG21	1:C:312:GLN:HE21	1.77	0.49
1:F:123:LEU:HG	1:F:300:VAL:HG21	1.94	0.49
1:G:146:VAL:HG21	1:G:312:GLN:HE21	1.77	0.49
1:J:189:KCX:HG2	1:J:227:PHE:HB2	1.94	0.49
1:A:200:ASN:OD1	1:A:205:ARG:HD3	2.13	0.48
1:D:230:ILE:O	1:D:237:MET:HG2	2.14	0.48
1:B:121:LEU:H	1:B:294:HIS:CD2	2.31	0.48
1:I:427:THR:HG22	5:I:827:HOH:O	2.12	0.48
1:G:121:LEU:H	1:G:294:HIS:HD2	1.60	0.48
1:B:108:ILE:CD1	1:B:126:LEU:HD11	2.35	0.48
1:E:161:VAL:H	1:E:389:GLN:NE2	2.11	0.48
1:C:189:KCX:HG2	1:C:227:PHE:HB2	1.94	0.48
1:H:358:SER:HB3	1:I:171:GLU:OE2	2.13	0.48
1:C:218:ASN:HB2	5:C:787:HOH:O	2.14	0.48
1:D:426:LYS:HG3	1:F:220:THR:O	2.13	0.48
1:F:105:LEU:HD23	1:F:108:ILE:HD11	1.96	0.48
1:J:163:LYS:HA	1:J:164:PRO:C	2.33	0.48
1:D:206:ALA:HA	1:D:226:TRP:CZ3	2.49	0.47
1:H:163:LYS:HA	1:H:164:PRO:C	2.35	0.47
1:I:256:VAL:HG12	1:I:264:LEU:HD11	1.95	0.47
1:J:303:LYS:NZ	1:J:354:GLN:HE21	2.12	0.47
1:B:78:HIS:CD2	1:B:349:VAL:HG21	2.49	0.47
1:H:286:ALA:HA	1:H:289:ASP:OD2	2.14	0.47
1:I:121:LEU:H	1:I:294:HIS:CD2	2.31	0.47
1:B:161:VAL:H	1:B:389:GLN:NE2	2.12	0.47
1:B:163:LYS:HA	1:B:164:PRO:C	2.34	0.47
1:D:48:ALA:HB1	1:D:53:GLY:HA3	1.97	0.47
1:F:366:SER:OG	1:F:378:VAL:HG11	2.15	0.47
1:I:163:LYS:HA	1:I:164:PRO:C	2.34	0.47
1:J:100:ASN:H	4:J:503:EDO:H12	1.79	0.47

*Continued on next page...*

*Continued from previous page...*

Atom-1	Atom-2	Interatomic distance (Å)	Clash overlap (Å)
1:D:398:PRO:HG2	1:D:433:ARG:O	2.15	0.46
1:E:174:GLU:HG3	1:E:212:ILE:HD11	1.97	0.46
1:E:303:LYS:NZ	1:E:354:GLN:HE21	2.13	0.46
1:A:45:ALA:HB2	1:A:117:ARG:HD2	1.97	0.46
1:H:136:PHE:HB3	1:H:307:LEU:O	2.14	0.46
1:B:115:MET:HB2	1:B:118:VAL:HG12	1.98	0.46
1:D:189:KCX:HG2	1:D:227:PHE:HB2	1.98	0.46
1:G:51:SER:OG	1:G:52:THR:N	2.47	0.46
1:F:326:GLY:HA3	5:F:732:HOH:O	2.15	0.45
1:J:206:ALA:HA	1:J:226:TRP:CZ3	2.51	0.45
1:G:303:LYS:HE2	1:G:354:GLN:HG2	1.98	0.45
1:H:163:LYS:H	1:H:395:LEU:HD22	1.81	0.45
1:E:348:ASP:OD2	1:E:351:HIS:HD2	1.99	0.45
1:B:283:ALA:O	1:B:284:MET:CB	2.64	0.44
1:C:163:LYS:HA	1:C:164:PRO:C	2.37	0.44
1:I:397:HIS:HA	1:I:398:PRO:HD2	1.75	0.44
1:F:427:THR:HG23	1:F:428:HIS:ND1	2.31	0.44
1:I:159:GLY:HA3	1:I:187:TYR:CE1	2.52	0.44
1:G:136:PHE:HB3	1:G:307:LEU:O	2.18	0.44
1:H:322:LYS:HA	1:H:443:PRO:O	2.17	0.44
1:C:286:ALA:HA	1:C:289:ASP:OD1	2.18	0.44
1:I:159:GLY:HA3	1:I:187:TYR:CE2	2.53	0.44
1:A:70:LEU:HD22	1:A:95:ALA:HA	2.00	0.43
1:E:163:LYS:HA	1:E:164:PRO:C	2.38	0.43
1:J:209:MET:HG2	1:J:226:TRP:CG	2.52	0.43
1:A:286:ALA:HA	1:A:289:ASP:OD2	2.18	0.43
1:B:376:GLN:N	1:B:377:PRO:HD2	2.33	0.43
1:I:70:LEU:HD22	1:I:95:ALA:HA	2.01	0.43
1:H:105:LEU:HD23	1:H:108:ILE:HD11	2.01	0.43
1:I:200:ASN:OD1	1:I:205:ARG:HD3	2.18	0.43
1:H:202:PHE:CD2	1:H:240:ARG:HG2	2.54	0.43
1:I:28:VAL:HG22	1:I:88:ARG:HG2	2.01	0.43
1:I:389:GLN:HE22	1:I:391:GLY:N	2.17	0.43
1:D:425:ALA:HB1	1:D:432:ALA:HB2	2.01	0.43
1:D:200:ASN:OD1	1:D:205:ARG:CG	2.67	0.43
1:F:220:THR:OG1	1:F:222:GLU:HG2	2.18	0.43
1:I:93:PHE:CE1	1:I:131:LYS:HE3	2.54	0.43
1:I:251:HIS:NE2	1:I:312:GLN:NE2	2.65	0.43
1:J:173:PHE:CE2	1:J:209:MET:CE	3.01	0.43
1:A:214:ASP:OD1	4:A:503:EDO:H21	2.18	0.43
1:H:303:LYS:NZ	1:H:354:GLN:HE21	2.17	0.43

*Continued on next page...*

*Continued from previous page...*

Atom-1	Atom-2	Interatomic distance (Å)	Clash overlap (Å)
1:A:86:ILE:HG21	1:A:349:VAL:O	2.19	0.43
1:I:181:LEU:HD21	1:I:188:MET:HG2	2.01	0.43
1:B:203:GLU:O	1:B:207:GLU:HG2	2.18	0.42
1:H:189:KCX:CX	3:H:502:CAP:HO3	2.32	0.42
1:H:371:HIS:HB2	1:H:372:PRO:HD2	2.01	0.42
1:D:149:MET:CE	1:D:251:HIS:CE1	3.02	0.42
1:D:364:PRO:HB2	1:D:386:ILE:HG22	2.02	0.42
1:G:283:ALA:O	1:G:284:MET:CB	2.67	0.42
1:D:286:ALA:HA	1:D:289:ASP:OD1	2.19	0.42
1:D:51:SER:OG	1:D:52:THR:N	2.51	0.42
1:D:149:MET:HE2	1:D:251:HIS:HE1	1.84	0.42
1:E:139:PRO:HD3	1:E:306:ARG:O	2.19	0.42
1:A:376:GLN:HB3	1:A:377:PRO:HD3	2.01	0.42
1:E:351:HIS:HE1	5:E:709:HOH:O	2.02	0.42
1:F:163:LYS:HA	1:F:164:PRO:C	2.39	0.42
1:I:158:TYR:CE1	1:I:408:VAL:HG11	2.55	0.42
1:B:371:HIS:HB2	1:B:372:PRO:HD2	2.02	0.41
1:C:291:ASN:HA	1:C:292:PRO:HD3	1.94	0.41
1:E:70:LEU:HD22	1:E:95:ALA:HA	2.01	0.41
1:F:136:PHE:HB3	1:F:307:LEU:O	2.20	0.41
1:H:146:VAL:HG21	1:H:312:GLN:HE21	1.84	0.41
1:G:303:LYS:NZ	1:G:354:GLN:HE21	2.18	0.41
1:C:303:LYS:NZ	1:C:354:GLN:HE21	2.18	0.41
1:C:206:ALA:HA	1:C:226:TRP:CZ3	2.56	0.41
1:F:208:ILE:HG22	1:F:209:MET:HE2	2.02	0.41
1:E:93:PHE:HB2	1:E:132:LEU:HD11	2.01	0.41
1:C:117:ARG:NH2	5:C:718:HOH:O	2.53	0.41
1:C:371:HIS:HB2	1:C:372:PRO:HD2	2.03	0.41
1:D:146:VAL:HG21	1:D:312:GLN:HE21	1.85	0.41
1:F:189:KCX:CX	3:F:502:CAP:HO3	2.32	0.41
1:E:206:ALA:HA	1:E:226:TRP:CZ3	2.55	0.41
1:G:286:ALA:HA	1:G:289:ASP:OD1	2.20	0.41
1:A:63:GLU:HG2	1:A:65:GLU:HG2	2.03	0.41
1:B:286:ALA:HA	1:B:289:ASP:OD1	2.21	0.41
1:F:319:GLY:HA2	5:F:679:HOH:O	2.19	0.41
1:J:391:GLY:O	1:J:395:LEU:HD12	2.21	0.41
1:B:406:ARG:HD3	1:B:430:GLU:HG2	2.02	0.40
1:E:303:LYS:HZ3	1:E:354:GLN:HE21	1.68	0.40
1:F:283:ALA:O	1:F:284:MET:CB	2.68	0.40
1:I:180:LEU:HD12	1:I:188:MET:HE1	2.03	0.40
1:E:322:LYS:HG3	1:E:323:LEU:HG	2.03	0.40

*Continued on next page...*

Continued from previous page...

Atom-1	Atom-2	Interatomic distance (Å)	Clash overlap (Å)
1:G:371:HIS:HB2	1:G:372:PRO:CD	2.52	0.40
1:D:158:TYR:CD1	1:D:408:VAL:HG11	2.57	0.40
1:F:200:ASN:OD1	1:F:205:ARG:HG3	2.21	0.40
1:J:146:VAL:HG21	1:J:312:GLN:HE21	1.85	0.40
1:H:376:GLN:HB3	1:H:377:PRO:HD3	2.03	0.40
1:I:158:TYR:CD1	1:I:408:VAL:HG11	2.55	0.40

There are no symmetry-related clashes.

## 5.3 Torsion angles [i](#)

### 5.3.1 Protein backbone [i](#)

In the following table, the Percentiles column shows the percent Ramachandran outliers of the chain as a percentile score with respect to all X-ray entries followed by that with respect to entries of similar resolution.

The Analysed column shows the number of residues for which the backbone conformation was analysed, and the total number of residues.

Mol	Chain	Analysed	Favoured	Allowed	Outliers	Percentiles	
1	A	434/444 (98%)	415 (96%)	19 (4%)	0	100	100
1	B	435/444 (98%)	414 (95%)	20 (5%)	1 (0%)	47	55
1	C	435/444 (98%)	419 (96%)	15 (3%)	1 (0%)	47	55
1	D	433/444 (98%)	416 (96%)	16 (4%)	1 (0%)	47	55
1	E	435/444 (98%)	420 (97%)	15 (3%)	0	100	100
1	F	433/444 (98%)	417 (96%)	15 (4%)	1 (0%)	47	55
1	G	433/444 (98%)	416 (96%)	16 (4%)	1 (0%)	47	55
1	H	434/444 (98%)	417 (96%)	17 (4%)	0	100	100
1	I	433/444 (98%)	415 (96%)	16 (4%)	2 (0%)	29	29
1	J	434/444 (98%)	419 (96%)	14 (3%)	1 (0%)	47	55
All	All	4339/4440 (98%)	4168 (96%)	163 (4%)	8 (0%)	47	55

All (8) Ramachandran outliers are listed below:

Mol	Chain	Res	Type
1	B	284	MET

Continued on next page...

*Continued from previous page...*

Mol	Chain	Res	Type
1	D	284	MET
1	I	284	MET
1	C	284	MET
1	G	284	MET
1	I	398	PRO
1	J	284	MET
1	F	325	GLY

### 5.3.2 Protein sidechains [i](#)

In the following table, the Percentiles column shows the percent sidechain outliers of the chain as a percentile score with respect to all X-ray entries followed by that with respect to entries of similar resolution.

The Analysed column shows the number of residues for which the sidechain conformation was analysed, and the total number of residues.

Mol	Chain	Analysed	Rotameric	Outliers	Percentiles
1	A	339/355 (96%)	335 (99%)	4 (1%)	71 80
1	B	341/355 (96%)	336 (98%)	5 (2%)	65 75
1	C	342/355 (96%)	338 (99%)	4 (1%)	71 80
1	D	345/355 (97%)	343 (99%)	2 (1%)	86 91
1	E	340/355 (96%)	336 (99%)	4 (1%)	71 80
1	F	336/355 (95%)	331 (98%)	5 (2%)	65 75
1	G	338/355 (95%)	333 (98%)	5 (2%)	65 75
1	H	338/355 (95%)	334 (99%)	4 (1%)	71 80
1	I	343/355 (97%)	338 (98%)	5 (2%)	65 75
1	J	341/355 (96%)	336 (98%)	5 (2%)	65 75
All	All	3403/3550 (96%)	3360 (99%)	43 (1%)	69 79

All (43) residues with a non-rotameric sidechain are listed below:

Mol	Chain	Res	Type
1	A	58	LEU
1	A	107	SER
1	A	268	ARG
1	A	363	PHE
1	B	107	SER
1	B	268	ARG

*Continued on next page...*

*Continued from previous page...*

Mol	Chain	Res	Type
1	B	363	PHE
1	B	406	ARG
1	B	429	LYS
1	C	107	SER
1	C	268	ARG
1	C	363	PHE
1	C	429	LYS
1	D	268	ARG
1	D	363	PHE
1	E	107	SER
1	E	268	ARG
1	E	363	PHE
1	E	376	GLN
1	F	35	GLU
1	F	40	GLU
1	F	191	ASP
1	F	268	ARG
1	F	363	PHE
1	G	59	TYR
1	G	107	SER
1	G	211	LYS
1	G	268	ARG
1	G	363	PHE
1	H	107	SER
1	H	175	LYS
1	H	268	ARG
1	H	363	PHE
1	I	115	MET
1	I	268	ARG
1	I	363	PHE
1	I	395	LEU
1	I	398	PRO
1	J	107	SER
1	J	268	ARG
1	J	289	ASP
1	J	363	PHE
1	J	427	THR

Sometimes sidechains can be flipped to improve hydrogen bonding and reduce clashes. All (49) such sidechains are listed below:

Mol	Chain	Res	Type
1	A	294	HIS

*Continued on next page...*

*Continued from previous page...*

<b>Mol</b>	<b>Chain</b>	<b>Res</b>	<b>Type</b>
1	A	312	GLN
1	A	354	GLN
1	A	389	GLN
1	B	64	GLN
1	B	78	HIS
1	B	279	HIS
1	B	294	HIS
1	B	312	GLN
1	B	354	GLN
1	B	389	GLN
1	C	41	GLN
1	C	294	HIS
1	C	312	GLN
1	C	354	GLN
1	C	389	GLN
1	D	294	HIS
1	D	312	GLN
1	D	354	GLN
1	D	389	GLN
1	E	312	GLN
1	E	351	HIS
1	E	354	GLN
1	E	389	GLN
1	E	410	GLN
1	F	78	HIS
1	F	294	HIS
1	F	312	GLN
1	F	354	GLN
1	F	389	GLN
1	G	279	HIS
1	G	294	HIS
1	G	312	GLN
1	G	354	GLN
1	G	389	GLN
1	H	41	GLN
1	H	279	HIS
1	H	294	HIS
1	H	312	GLN
1	H	354	GLN
1	H	389	GLN
1	I	294	HIS
1	I	312	GLN

*Continued on next page...*



*Continued from previous page...*

Mol	Chain	Res	Type
1	I	332	GLN
1	I	354	GLN
1	I	389	GLN
1	J	312	GLN
1	J	354	GLN
1	J	389	GLN

### 5.3.3 RNA [i](#)

There are no RNA molecules in this entry.

## 5.4 Non-standard residues in protein, DNA, RNA chains [i](#)

10 non-standard protein/DNA/RNA residues are modelled in this entry.

In the following table, the Counts columns list the number of bonds (or angles) for which Mogul statistics could be retrieved, the number of bonds (or angles) that are observed in the model and the number of bonds (or angles) that are defined in the Chemical Component Dictionary. The Link column lists molecule types, if any, to which the group is linked. The Z score for a bond length (or angle) is the number of standard deviations the observed value is removed from the expected value. A bond length (or angle) with  $|Z| > 2$  is considered an outlier worth inspection. RMSZ is the root-mean-square of all Z scores of the bond lengths (or angles).

Mol	Type	Chain	Res	Link	Bond lengths			Bond angles		
					Counts	RMSZ	$\# Z  > 2$	Counts	RMSZ	$\# Z  > 2$
1	KCX	I	189	2,1	10,11,12	0.58	0	6,12,14	0.58	0
1	KCX	E	189	2,1	10,11,12	0.55	0	6,12,14	0.73	0
1	KCX	J	189	2,1	10,11,12	0.52	0	6,12,14	0.64	0
1	KCX	G	189	2,1	10,11,12	0.48	0	6,12,14	0.64	0
1	KCX	D	189	2,1	10,11,12	0.63	0	6,12,14	0.62	0
1	KCX	H	189	2,1	10,11,12	0.53	0	6,12,14	0.69	0
1	KCX	F	189	2,1	10,11,12	0.58	0	6,12,14	0.62	0
1	KCX	C	189	2,1	10,11,12	0.52	0	6,12,14	0.56	0
1	KCX	A	189	2,1	10,11,12	0.53	0	6,12,14	0.73	0
1	KCX	B	189	2,1	10,11,12	0.50	0	6,12,14	0.66	0

In the following table, the Chirals column lists the number of chiral outliers, the number of chiral centers analysed, the number of these observed in the model and the number defined in the Chemical Component Dictionary. Similar counts are reported in the Torsion and Rings columns. '-' means no outliers of that kind were identified.

Mol	Type	Chain	Res	Link	Chirals	Torsions	Rings
1	KCX	I	189	2,1	-	0/9/10/12	-
1	KCX	E	189	2,1	-	0/9/10/12	-
1	KCX	J	189	2,1	-	0/9/10/12	-
1	KCX	G	189	2,1	-	0/9/10/12	-
1	KCX	D	189	2,1	-	0/9/10/12	-
1	KCX	H	189	2,1	-	0/9/10/12	-
1	KCX	F	189	2,1	-	0/9/10/12	-
1	KCX	C	189	2,1	-	0/9/10/12	-
1	KCX	A	189	2,1	-	0/9/10/12	-
1	KCX	B	189	2,1	-	0/9/10/12	-

There are no bond length outliers.

There are no bond angle outliers.

There are no chirality outliers.

There are no torsion outliers.

There are no ring outliers.

10 monomers are involved in 12 short contacts:

Mol	Chain	Res	Type	Clashes	Symm-Clashes
1	I	189	KCX	1	0
1	E	189	KCX	1	0
1	J	189	KCX	1	0
1	G	189	KCX	1	0
1	D	189	KCX	1	0
1	H	189	KCX	2	0
1	F	189	KCX	2	0
1	C	189	KCX	1	0
1	A	189	KCX	1	0
1	B	189	KCX	1	0

## 5.5 Carbohydrates [i](#)

There are no monosaccharides in this entry.

## 5.6 Ligand geometry [i](#)

Of 30 ligands modelled in this entry, 10 are monoatomic - leaving 20 for Mogul analysis.

In the following table, the Counts columns list the number of bonds (or angles) for which Mogul statistics could be retrieved, the number of bonds (or angles) that are observed in the model and

the number of bonds (or angles) that are defined in the Chemical Component Dictionary. The Link column lists molecule types, if any, to which the group is linked. The Z score for a bond length (or angle) is the number of standard deviations the observed value is removed from the expected value. A bond length (or angle) with  $|Z| > 2$  is considered an outlier worth inspection. RMSZ is the root-mean-square of all Z scores of the bond lengths (or angles).

Mol	Type	Chain	Res	Link	Bond lengths			Bond angles		
					Counts	RMSZ	# Z  > 2	Counts	RMSZ	# Z  > 2
4	EDO	H	504	-	3,3,3	0.49	0	2,2,2	0.25	0
3	CAP	D	502	2	18,20,20	0.87	0	23,31,31	0.91	0
3	CAP	A	502	2	18,20,20	0.71	0	23,31,31	1.04	1 (4%)
4	EDO	H	503	-	3,3,3	0.45	0	2,2,2	0.31	0
3	CAP	B	502	2	18,20,20	0.80	0	23,31,31	1.01	1 (4%)
3	CAP	I	502	2	18,20,20	0.80	0	23,31,31	1.10	1 (4%)
4	EDO	A	503	-	3,3,3	0.48	0	2,2,2	0.18	0
4	EDO	C	503	-	3,3,3	0.48	0	2,2,2	0.29	0
4	EDO	E	503	-	3,3,3	0.52	0	2,2,2	0.20	0
4	EDO	D	503	-	3,3,3	0.42	0	2,2,2	0.45	0
4	EDO	I	504	-	3,3,3	0.51	0	2,2,2	0.20	0
3	CAP	G	502	2	18,20,20	0.80	0	23,31,31	1.04	1 (4%)
3	CAP	F	502	2	18,20,20	0.75	0	23,31,31	1.09	2 (8%)
4	EDO	B	503	-	3,3,3	0.40	0	2,2,2	0.40	0
3	CAP	H	502	2	18,20,20	0.75	0	23,31,31	0.98	1 (4%)
3	CAP	E	502	2	18,20,20	0.78	0	23,31,31	1.03	1 (4%)
4	EDO	I	503	-	3,3,3	0.46	0	2,2,2	0.25	0
3	CAP	J	502	2	18,20,20	0.78	0	23,31,31	0.95	0
3	CAP	C	502	2	18,20,20	0.78	0	23,31,31	0.97	0
4	EDO	J	503	-	3,3,3	0.66	0	2,2,2	0.21	0

In the following table, the Chirals column lists the number of chiral outliers, the number of chiral centers analysed, the number of these observed in the model and the number defined in the Chemical Component Dictionary. Similar counts are reported in the Torsion and Rings columns. '-' means no outliers of that kind were identified.

Mol	Type	Chain	Res	Link	Chirals	Torsions	Rings
4	EDO	H	504	-	-	1/1/1/1	-
3	CAP	D	502	2	-	8/29/29/29	-
3	CAP	A	502	2	-	7/29/29/29	-
4	EDO	H	503	-	-	0/1/1/1	-
3	CAP	B	502	2	-	7/29/29/29	-
3	CAP	I	502	2	-	6/29/29/29	-
4	EDO	A	503	-	-	1/1/1/1	-

*Continued on next page...*

Continued from previous page...

Mol	Type	Chain	Res	Link	Chirals	Torsions	Rings
4	EDO	C	503	-	-	0/1/1/1	-
4	EDO	E	503	-	-	1/1/1/1	-
4	EDO	D	503	-	-	0/1/1/1	-
4	EDO	I	504	-	-	0/1/1/1	-
3	CAP	G	502	2	-	6/29/29/29	-
3	CAP	F	502	2	-	7/29/29/29	-
4	EDO	B	503	-	-	1/1/1/1	-
3	CAP	H	502	2	-	8/29/29/29	-
3	CAP	E	502	2	-	9/29/29/29	-
4	EDO	I	503	-	-	0/1/1/1	-
3	CAP	J	502	2	-	9/29/29/29	-
3	CAP	C	502	2	-	6/29/29/29	-
4	EDO	J	503	-	-	0/1/1/1	-

There are no bond length outliers.

All (8) bond angle outliers are listed below:

Mol	Chain	Res	Type	Atoms	Z	Observed(°)	Ideal(°)
3	F	502	CAP	O7-C-C2	2.60	118.41	114.06
3	F	502	CAP	O6P-P2-O5P	2.40	116.81	107.80
3	E	502	CAP	O7-C-C2	2.29	117.89	114.06
3	A	502	CAP	O7-C-C2	2.18	117.71	114.06
3	H	502	CAP	O7-C-C2	2.14	117.64	114.06
3	B	502	CAP	O7-C-C2	2.11	117.59	114.06
3	I	502	CAP	O6P-P2-O5P	2.10	115.69	107.80
3	G	502	CAP	O7-C-C2	2.07	117.53	114.06

There are no chirality outliers.

All (77) torsion outliers are listed below:

Mol	Chain	Res	Type	Atoms
3	A	502	CAP	O6-C-C2-C1
3	A	502	CAP	O7-C-C2-C1
3	A	502	CAP	O6-C-C2-O2
3	A	502	CAP	O7-C-C2-O2
3	A	502	CAP	O3-C3-C4-O4
3	B	502	CAP	O6-C-C2-O2
3	B	502	CAP	O7-C-C2-O2
3	B	502	CAP	O3-C3-C4-O4
3	C	502	CAP	O6-C-C2-C1

Continued on next page...

*Continued from previous page...*

Mol	Chain	Res	Type	Atoms
3	C	502	CAP	O7-C-C2-C1
3	C	502	CAP	O6-C-C2-O2
3	C	502	CAP	O7-C-C2-O2
3	C	502	CAP	O3-C3-C4-O4
3	D	502	CAP	O6-C-C2-C3
3	D	502	CAP	O6-C-C2-O2
3	D	502	CAP	O3-C3-C4-O4
3	E	502	CAP	O6-C-C2-C1
3	E	502	CAP	O7-C-C2-C1
3	E	502	CAP	O6-C-C2-O2
3	E	502	CAP	O7-C-C2-O2
3	E	502	CAP	C2-C3-C4-O4
3	E	502	CAP	O3-C3-C4-O4
3	F	502	CAP	O6-C-C2-C1
3	F	502	CAP	O7-C-C2-C1
3	F	502	CAP	O6-C-C2-O2
3	F	502	CAP	O7-C-C2-O2
3	F	502	CAP	C2-C3-C4-O4
3	F	502	CAP	O3-C3-C4-O4
3	G	502	CAP	O6-C-C2-C1
3	G	502	CAP	O7-C-C2-C1
3	G	502	CAP	O6-C-C2-O2
3	G	502	CAP	O7-C-C2-O2
3	H	502	CAP	O6-C-C2-C1
3	H	502	CAP	O7-C-C2-C1
3	H	502	CAP	O6-C-C2-O2
3	H	502	CAP	O7-C-C2-O2
3	H	502	CAP	O3-C3-C4-O4
3	I	502	CAP	O6-C-C2-C1
3	I	502	CAP	O7-C-C2-C1
3	I	502	CAP	O6-C-C2-O2
3	I	502	CAP	O7-C-C2-O2
3	I	502	CAP	O3-C3-C4-O4
3	J	502	CAP	O6-C-C2-O2
3	J	502	CAP	O7-C-C2-O2
3	J	502	CAP	O3-C3-C4-O4
3	B	502	CAP	O6-C-C2-C1
3	B	502	CAP	O7-C-C2-C1
3	D	502	CAP	O6-C-C2-C1
3	J	502	CAP	O6-C-C2-C1
3	J	502	CAP	O7-C-C2-C1
3	D	502	CAP	O7-C-C2-O2

*Continued on next page...*

*Continued from previous page...*

Mol	Chain	Res	Type	Atoms
3	A	502	CAP	C2-C3-C4-O4
3	G	502	CAP	O3-C3-C4-O4
3	D	502	CAP	O7-C-C2-C1
3	J	502	CAP	O1-C1-C2-O2
3	A	502	CAP	O2-C2-C3-C4
3	B	502	CAP	O2-C2-C3-C4
3	C	502	CAP	O2-C2-C3-C4
3	D	502	CAP	O2-C2-C3-C4
3	E	502	CAP	O2-C2-C3-C4
3	F	502	CAP	O2-C2-C3-C4
3	G	502	CAP	O2-C2-C3-C4
3	H	502	CAP	O2-C2-C3-C4
3	I	502	CAP	O2-C2-C3-C4
3	J	502	CAP	O2-C2-C3-C4
3	J	502	CAP	C2-C3-C4-O4
3	H	502	CAP	C5-O5-P2-O4P
3	B	502	CAP	O7-C-C2-C3
3	D	502	CAP	O7-C-C2-C3
4	H	504	EDO	O1-C1-C2-O2
3	H	502	CAP	C2-C3-C4-O4
3	E	502	CAP	C4-C5-O5-P2
3	E	502	CAP	C5-O5-P2-O4P
4	B	503	EDO	O1-C1-C2-O2
3	J	502	CAP	O4-C4-C5-O5
4	E	503	EDO	O1-C1-C2-O2
4	A	503	EDO	O1-C1-C2-O2

There are no ring outliers.

4 monomers are involved in 4 short contacts:

Mol	Chain	Res	Type	Clashes	Symm-Clashes
4	A	503	EDO	1	0
3	F	502	CAP	1	0
3	H	502	CAP	1	0
4	J	503	EDO	1	0

The following is a two-dimensional graphical depiction of Mogul quality analysis of bond lengths, bond angles, torsion angles, and ring geometry for all instances of the Ligand of Interest. In addition, ligands with molecular weight > 250 and outliers as shown on the validation Tables will also be included. For torsion angles, if less than 5% of the Mogul distribution of torsion angles is within 10 degrees of the torsion angle in question, then that torsion angle is considered an outlier. Any bond that is central to one or more torsion angles identified as an outlier by Mogul will be

highlighted in the graph. For rings, the root-mean-square deviation (RMSD) between the ring in question and similar rings identified by Mogul is calculated over all ring torsion angles. If the average RMSD is greater than 60 degrees and the minimal RMSD between the ring in question and any Mogul-identified rings is also greater than 60 degrees, then that ring is considered an outlier. The outliers are highlighted in purple. The color gray indicates Mogul did not find sufficient equivalents in the CSD to analyse the geometry.

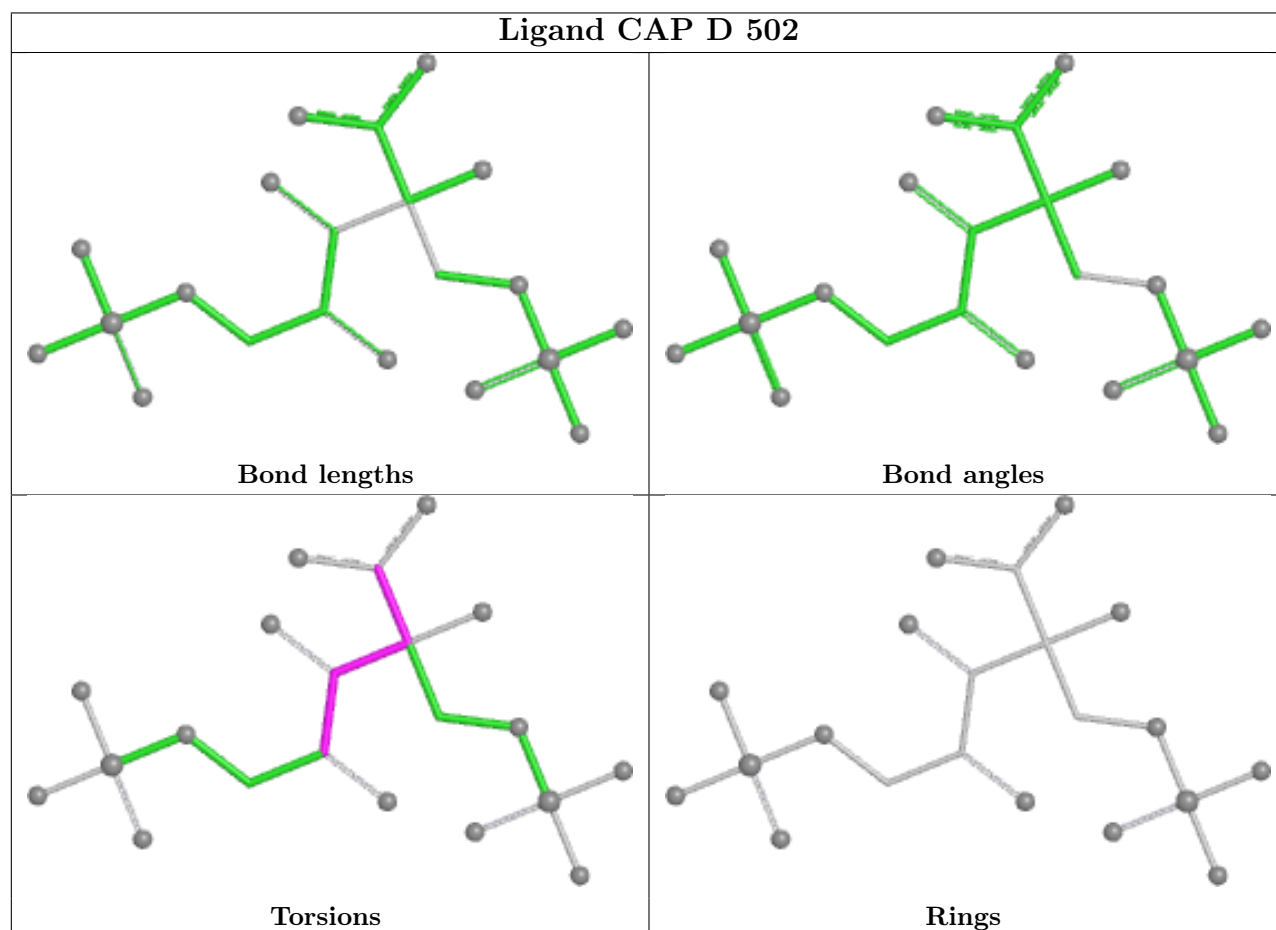

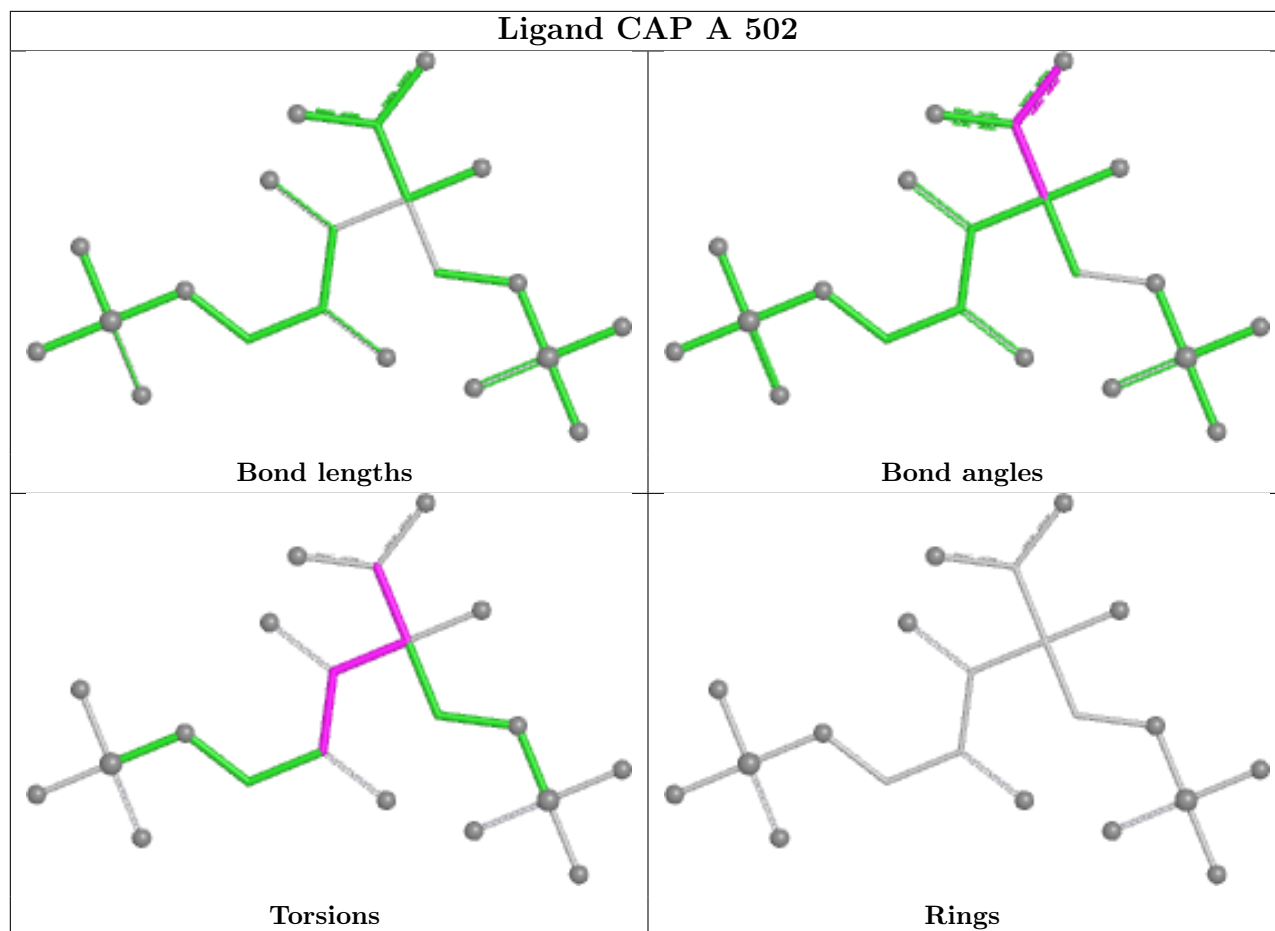



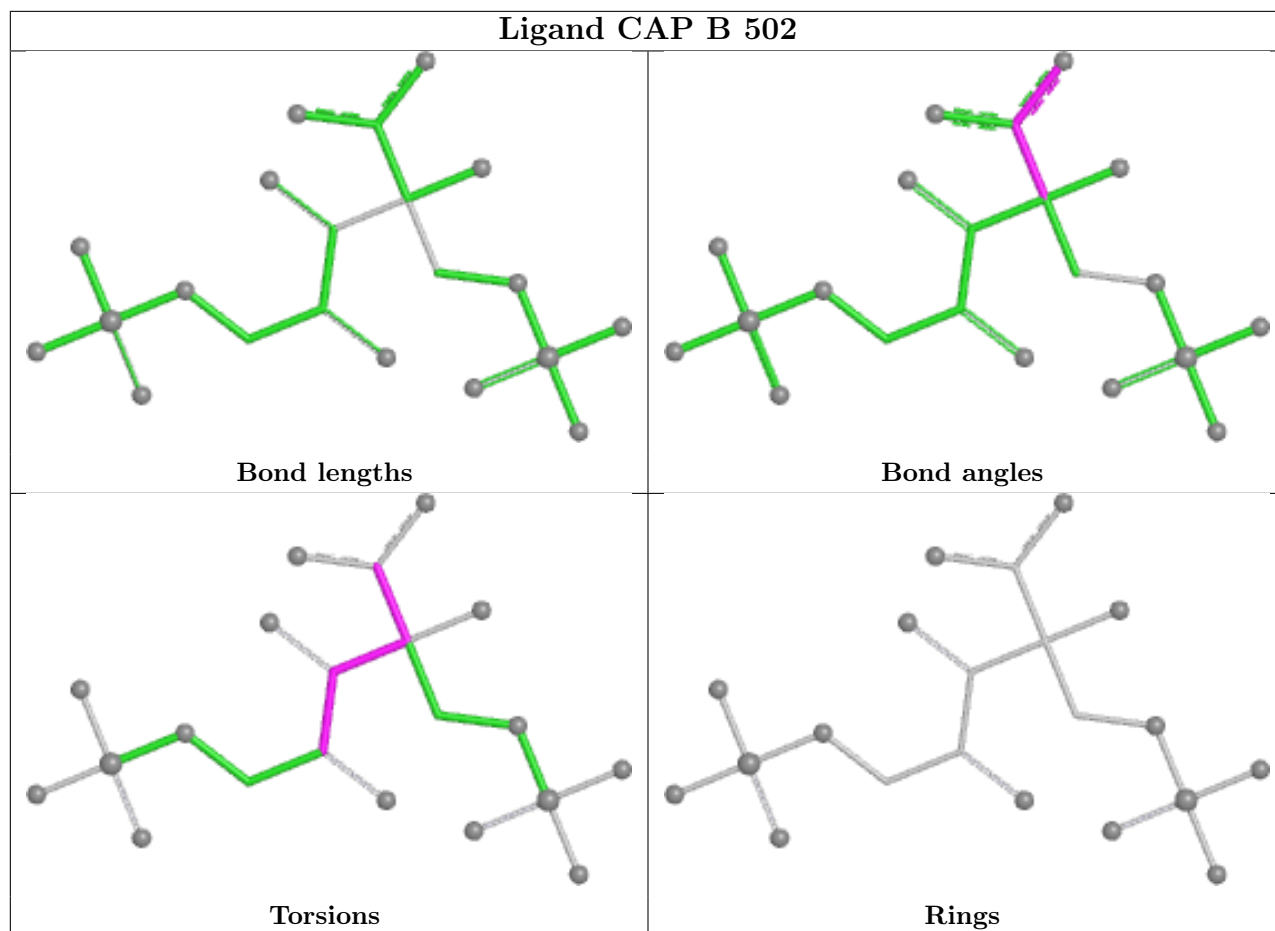

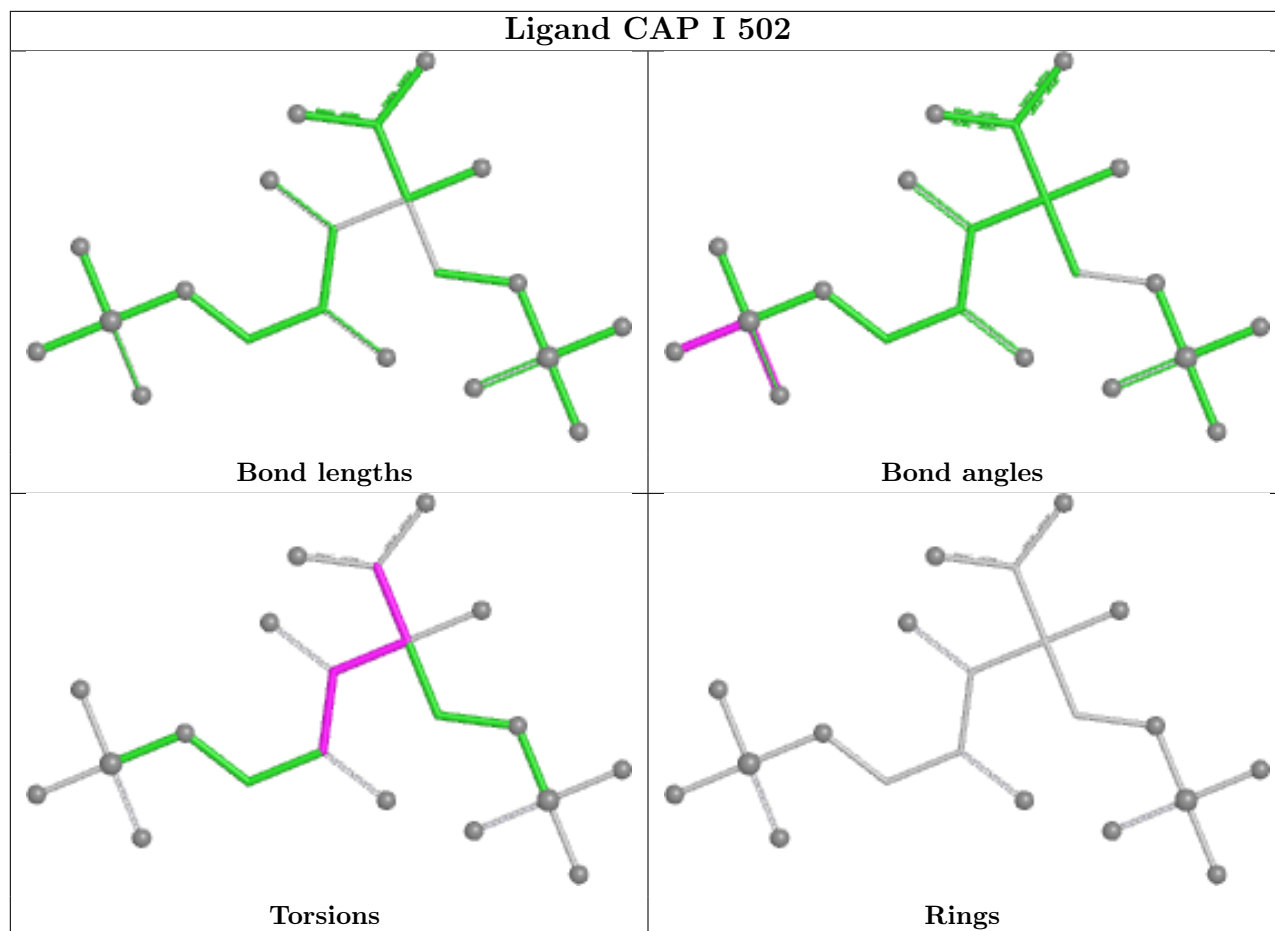

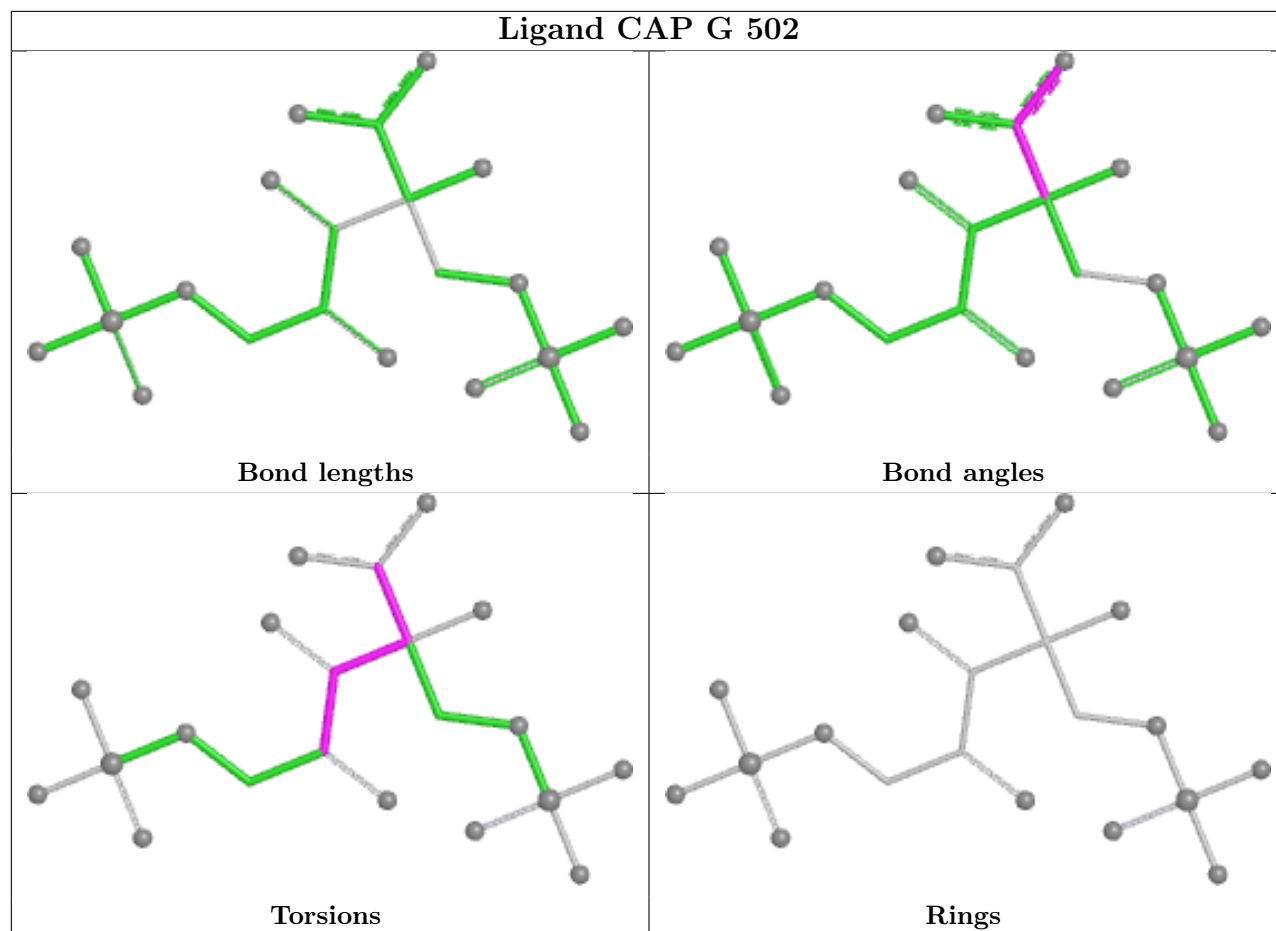

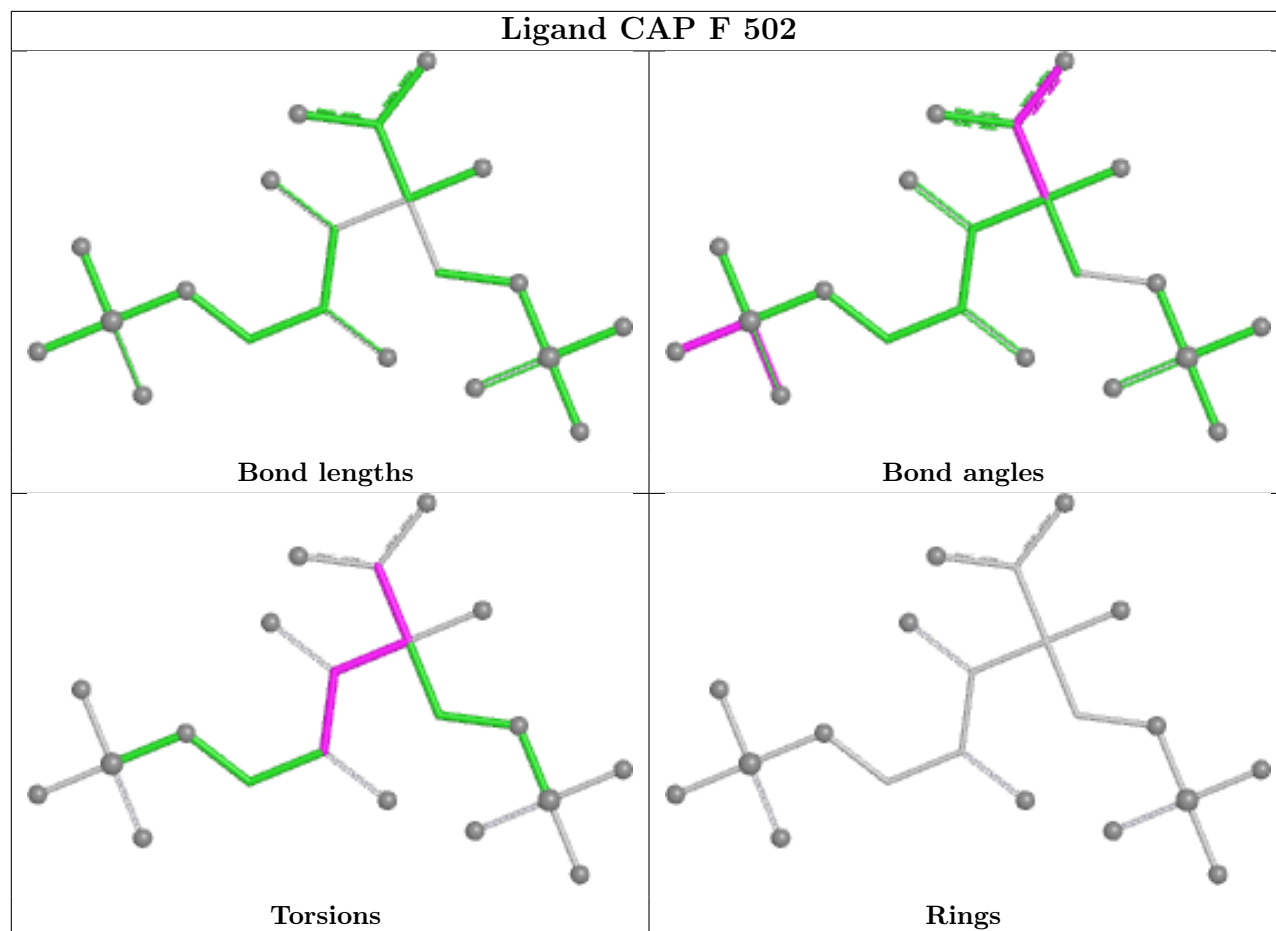

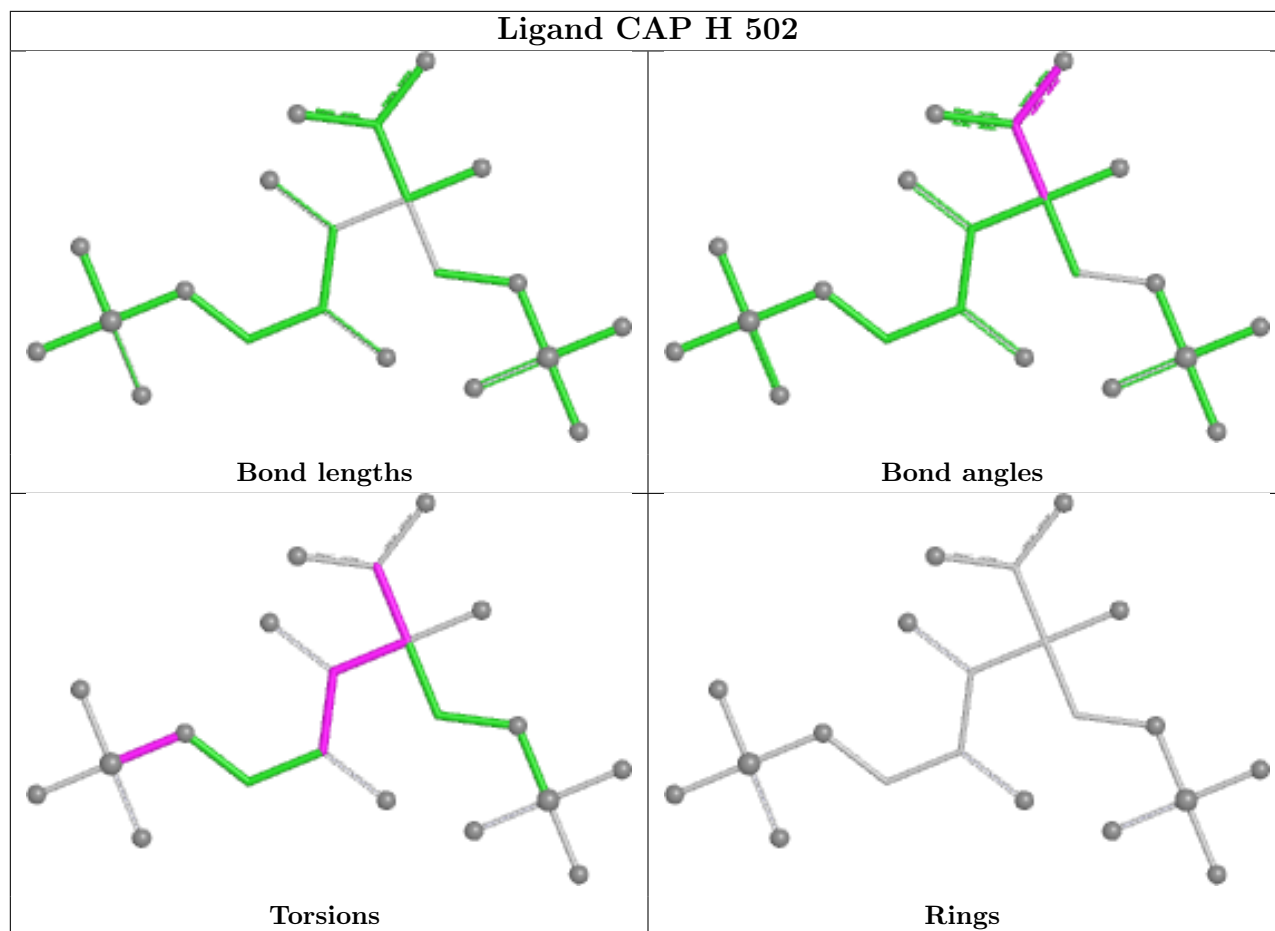

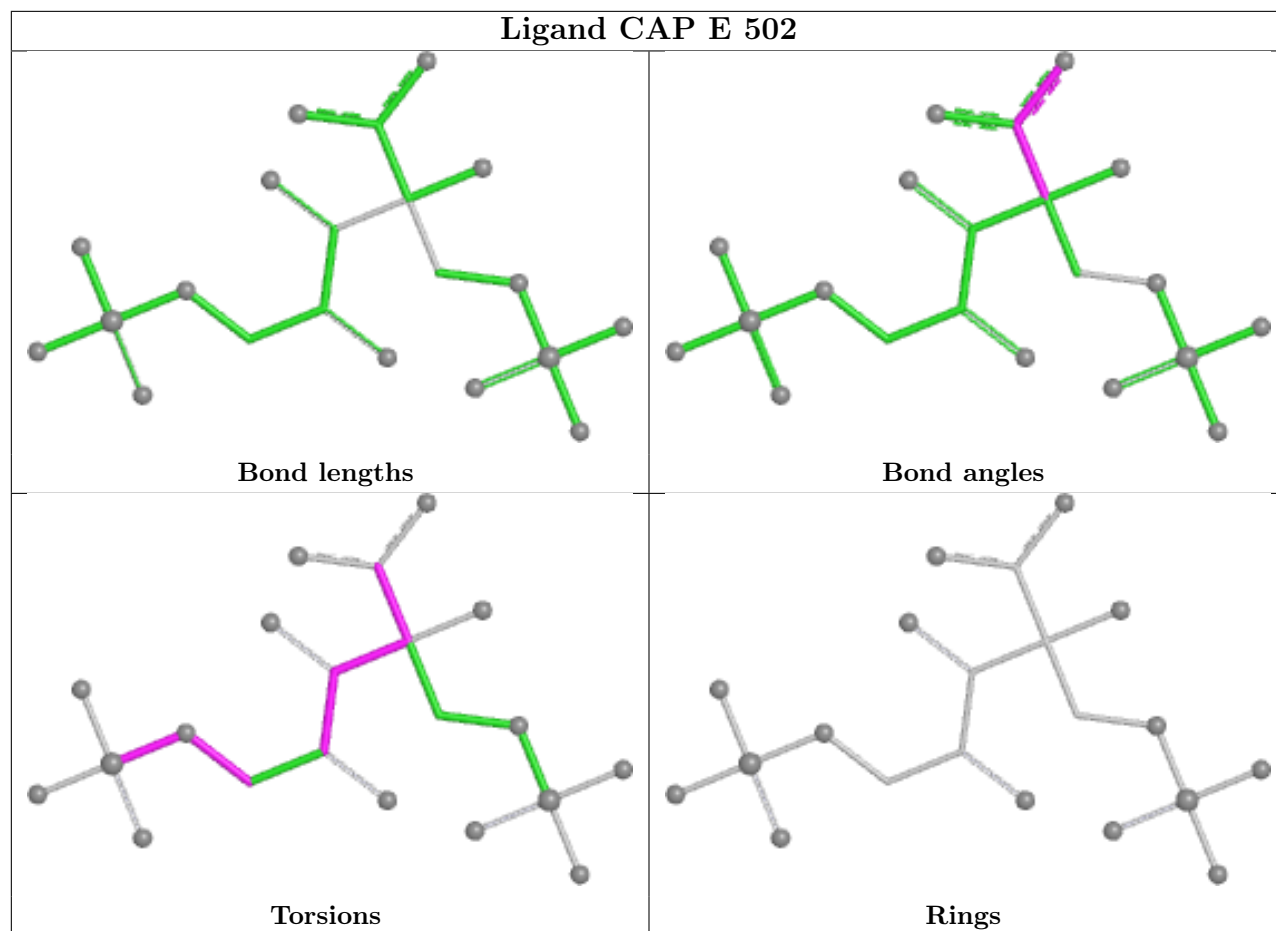

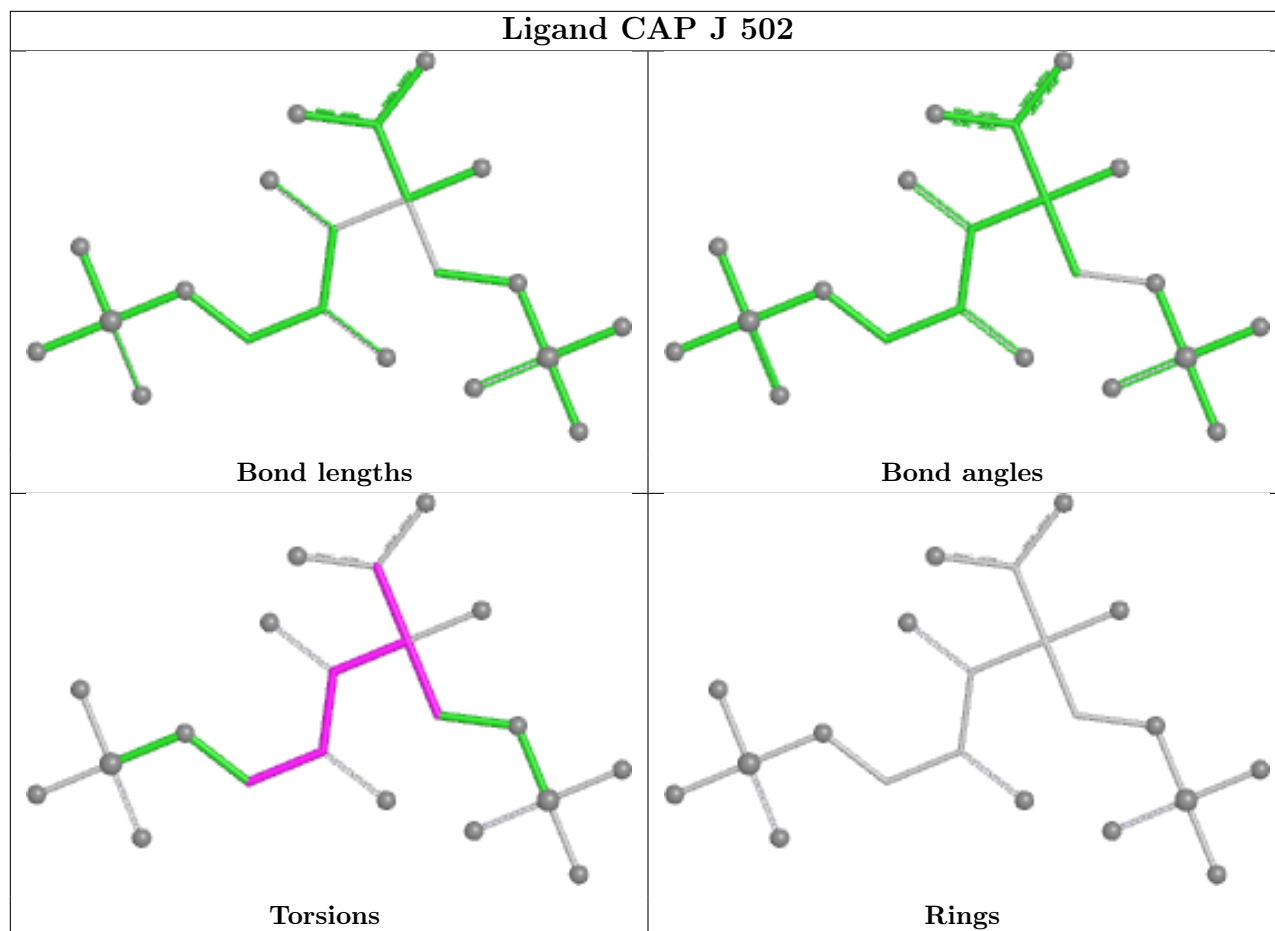

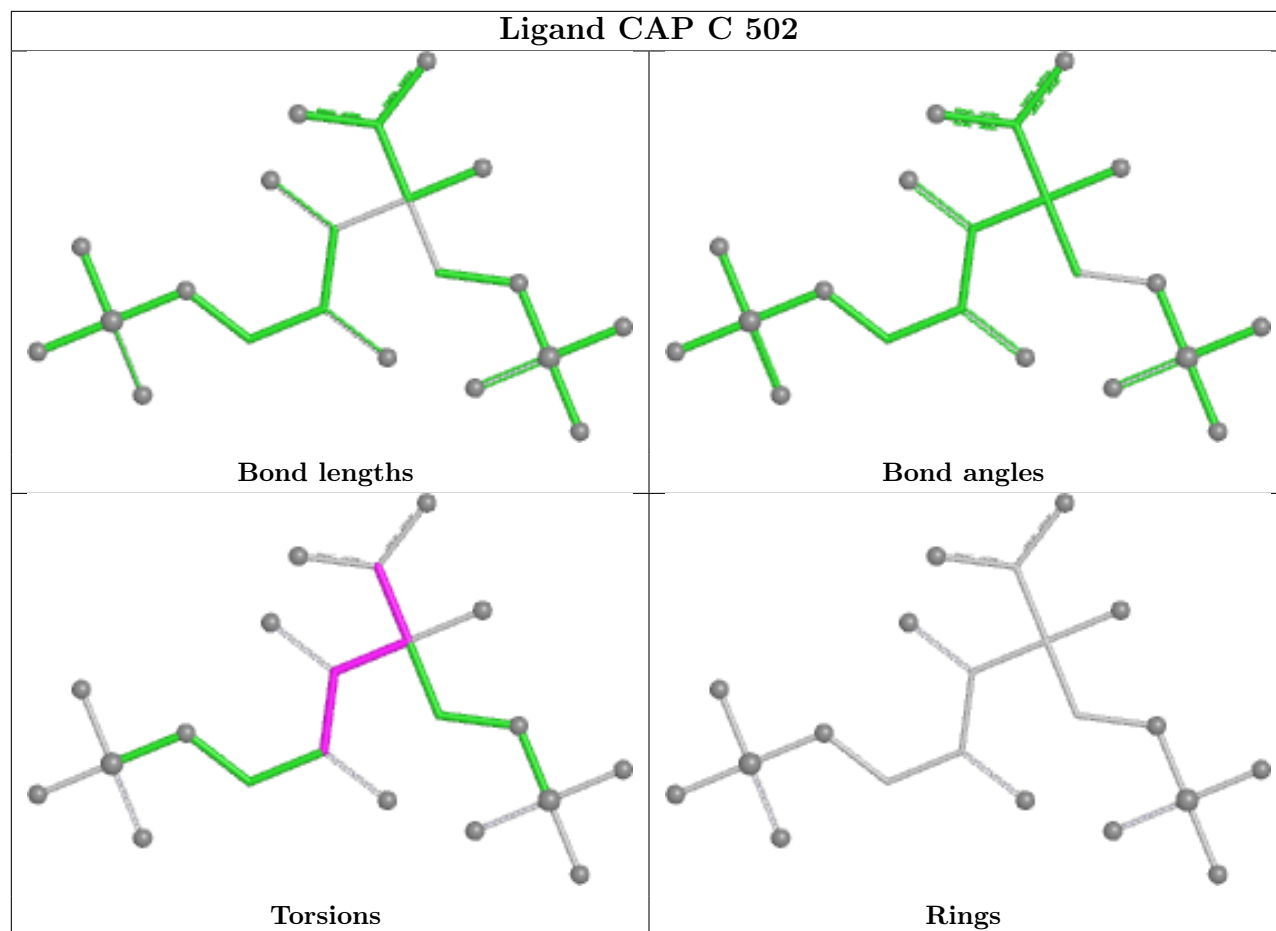

## 5.7 Other polymers [i](#)

There are no such residues in this entry.

## 5.8 Polymer linkage issues [i](#)

There are no chain breaks in this entry.



## 6 Fit of model and data

### 6.1 Protein, DNA and RNA chains

In the following table, the column labelled ‘#RSRZ > 2’ contains the number (and percentage) of RSRZ outliers, followed by percent RSRZ outliers for the chain as percentile scores relative to all X-ray entries and entries of similar resolution. The OWAB column contains the minimum, median, 95<sup>th</sup> percentile and maximum values of the occupancy-weighted average B-factor per residue. The column labelled ‘Q < 0.9’ lists the number of (and percentage) of residues with an average occupancy less than 0.9.

Mol	Chain	Analysed	<RSRZ>	#RSRZ>2	OWAB(Å <sup>2</sup> )	Q<0.9
1	A	436/444 (98%)	0.17	20 (4%) 32 35	30, 49, 71, 89	0
1	B	437/444 (98%)	0.48	44 (10%) 7 7	38, 58, 90, 108	0
1	C	437/444 (98%)	0.07	20 (4%) 32 35	28, 43, 76, 95	0
1	D	435/444 (97%)	0.29	31 (7%) 16 17	26, 50, 80, 93	0
1	E	437/444 (98%)	0.13	29 (6%) 18 20	24, 42, 84, 101	0
1	F	435/444 (97%)	0.53	40 (9%) 9 9	32, 62, 94, 123	0
1	G	435/444 (97%)	0.64	62 (14%) 2 2	40, 58, 87, 109	0
1	H	436/444 (98%)	0.39	47 (10%) 5 5	32, 53, 95, 122	0
1	I	435/444 (97%)	0.08	14 (3%) 47 50	25, 46, 77, 92	0
1	J	436/444 (98%)	0.08	25 (5%) 23 25	25, 40, 79, 96	0
All	All	4359/4440 (98%)	0.29	332 (7%) 13 15	24, 50, 85, 123	0

All (332) RSRZ outliers are listed below:

Mol	Chain	Res	Type	RSRZ
1	H	421	LEU	6.0
1	A	59	TYR	5.6
1	J	414	ALA	5.5
1	I	9	TYR	5.3
1	G	421	LEU	5.3
1	D	9	TYR	5.3
1	J	444	VAL	5.1
1	F	414	ALA	4.8
1	G	258	ILE	4.8
1	G	257	VAL	4.8
1	A	8	ILE	4.7
1	G	414	ALA	4.6
1	G	410	GLN	4.6

*Continued on next page...*

*Continued from previous page...*

<b>Mol</b>	<b>Chain</b>	<b>Res</b>	<b>Type</b>	<b>RSRZ</b>
1	G	58	LEU	4.6
1	H	424	TYR	4.5
1	H	434	ALA	4.5
1	D	54	THR	4.5
1	C	421	LEU	4.4
1	G	403	ALA	4.4
1	J	424	TYR	4.4
1	G	284	MET	4.4
1	G	287	ALA	4.4
1	G	283	ALA	4.4
1	G	16	GLY	4.3
1	G	59	TYR	4.3
1	F	421	LEU	4.3
1	H	441	VAL	4.3
1	H	427	THR	4.3
1	G	256	VAL	4.2
1	B	288	PHE	4.2
1	B	398	PRO	4.2
1	A	257	VAL	4.1
1	F	16	GLY	4.1
1	B	8	ILE	4.0
1	H	396	GLY	4.0
1	H	417	GLN	4.0
1	B	57	THR	4.0
1	G	296	ILE	3.9
1	D	261	TRP	3.9
1	B	287	ALA	3.9
1	B	414	ALA	3.9
1	G	109	ALA	3.9
1	G	288	PHE	3.9
1	H	439	GLY	3.9
1	J	417	GLN	3.9
1	E	258	ILE	3.8
1	H	419	ILE	3.8
1	G	261	TRP	3.8
1	B	296	ILE	3.7
1	G	105	LEU	3.7
1	F	424	TYR	3.7
1	G	426	LYS	3.7
1	F	441	VAL	3.7
1	F	398	PRO	3.7
1	I	347	ASN	3.6

*Continued on next page...*

*Continued from previous page...*

<b>Mol</b>	<b>Chain</b>	<b>Res</b>	<b>Type</b>	<b>RSRZ</b>
1	B	284	MET	3.6
1	C	419	ILE	3.6
1	D	58	LEU	3.6
1	E	444	VAL	3.6
1	G	424	TYR	3.6
1	G	346	GLU	3.6
1	J	425	ALA	3.5
1	D	257	VAL	3.5
1	B	258	ILE	3.5
1	D	105	LEU	3.5
1	G	106	ALA	3.5
1	D	347	ASN	3.5
1	B	152	ILE	3.5
1	B	283	ALA	3.5
1	E	434	ALA	3.4
1	C	420	PRO	3.4
1	B	439	GLY	3.4
1	J	418	GLY	3.4
1	D	59	TYR	3.4
1	F	256	VAL	3.3
1	H	283	ALA	3.3
1	F	376	GLN	3.3
1	D	101	LEU	3.3
1	D	56	THR	3.3
1	C	59	TYR	3.3
1	H	59	TYR	3.2
1	H	257	VAL	3.2
1	B	434	ALA	3.2
1	B	105	LEU	3.2
1	G	101	LEU	3.2
1	B	85	TRP	3.2
1	J	59	TYR	3.2
1	C	441	VAL	3.2
1	B	417	GLN	3.1
1	H	376	GLN	3.1
1	H	412	ILE	3.1
1	G	113	PHE	3.1
1	F	425	ALA	3.1
1	H	400	GLY	3.1
1	A	418	GLY	3.1
1	G	11	TYR	3.1
1	C	258	ILE	3.1

*Continued on next page...*

*Continued from previous page...*

<b>Mol</b>	<b>Chain</b>	<b>Res</b>	<b>Type</b>	<b>RSRZ</b>
1	H	373	GLY	3.1
1	F	403	ALA	3.1
1	F	257	VAL	3.1
1	F	417	GLN	3.1
1	B	59	TYR	3.0
1	J	431	LEU	3.0
1	D	346	GLU	3.0
1	H	431	LEU	3.0
1	I	59	TYR	3.0
1	H	418	GLY	3.0
1	G	57	THR	3.0
1	H	420	PRO	3.0
1	C	426	LYS	3.0
1	D	258	ILE	3.0
1	F	432	ALA	3.0
1	D	256	VAL	3.0
1	E	256	VAL	3.0
1	E	257	VAL	3.0
1	B	256	VAL	2.9
1	B	257	VAL	2.9
1	G	347	ASN	2.9
1	I	54	THR	2.9
1	J	421	LEU	2.9
1	B	396	GLY	2.9
1	B	400	GLY	2.9
1	A	256	VAL	2.9
1	G	259	THR	2.9
1	B	410	GLN	2.9
1	E	421	LEU	2.9
1	A	258	ILE	2.9
1	I	57	THR	2.9
1	B	113	PHE	2.9
1	G	285	HIS	2.9
1	H	258	ILE	2.8
1	F	420	PRO	2.8
1	A	9	TYR	2.8
1	D	288	PHE	2.8
1	A	101	LEU	2.8
1	D	102	PRO	2.8
1	E	400	GLY	2.8
1	D	109	ALA	2.8
1	C	257	VAL	2.8

*Continued on next page...*

*Continued from previous page...*

<b>Mol</b>	<b>Chain</b>	<b>Res</b>	<b>Type</b>	<b>RSRZ</b>
1	J	403	ALA	2.8
1	H	442	THR	2.8
1	E	376	GLN	2.8
1	C	376	GLN	2.7
1	H	375	ILE	2.7
1	G	398	PRO	2.7
1	G	418	GLY	2.7
1	J	398	PRO	2.7
1	B	261	TRP	2.7
1	G	152	ILE	2.7
1	C	398	PRO	2.7
1	D	55	TRP	2.7
1	G	222	GLU	2.7
1	G	54	THR	2.7
1	H	399	ASP	2.7
1	D	283	ALA	2.7
1	G	431	LEU	2.7
1	B	403	ALA	2.7
1	H	284	MET	2.7
1	H	398	PRO	2.7
1	G	17	TYR	2.7
1	E	7	THR	2.7
1	B	404	GLY	2.7
1	G	60	PRO	2.6
1	D	259	THR	2.6
1	A	380	GLU	2.6
1	G	412	ILE	2.6
1	F	416	MET	2.6
1	G	9	TYR	2.6
1	F	57	THR	2.6
1	B	301	LEU	2.6
1	A	347	ASN	2.6
1	E	442	THR	2.6
1	G	264	LEU	2.6
1	I	105	LEU	2.6
1	H	404	GLY	2.6
1	F	101	LEU	2.5
1	G	104	LEU	2.5
1	G	10	ASP	2.5
1	F	106	ALA	2.5
1	H	347	ASN	2.5
1	D	57	THR	2.5

*Continued on next page...*

*Continued from previous page...*

<b>Mol</b>	<b>Chain</b>	<b>Res</b>	<b>Type</b>	<b>RSRZ</b>
1	G	102	PRO	2.5
1	H	435	LEU	2.5
1	G	416	MET	2.5
1	G	305	TYR	2.5
1	A	109	ALA	2.5
1	C	427	THR	2.5
1	B	223	LYS	2.5
1	C	373	GLY	2.5
1	G	301	LEU	2.5
1	J	257	VAL	2.5
1	J	432	ALA	2.5
1	B	401	PRO	2.5
1	G	419	ILE	2.5
1	H	415	ILE	2.5
1	B	436	GLU	2.5
1	D	85	TRP	2.5
1	F	405	ALA	2.5
1	D	260	GLY	2.5
1	F	423	GLU	2.5
1	E	380	GLU	2.5
1	F	412	ILE	2.5
1	F	58	LEU	2.5
1	F	399	ASP	2.5
1	F	435	LEU	2.5
1	A	57	THR	2.4
1	B	285	HIS	2.4
1	F	36	GLY	2.4
1	I	257	VAL	2.4
1	C	418	GLY	2.4
1	F	59	TYR	2.4
1	B	412	ILE	2.4
1	F	18	GLU	2.4
1	F	258	ILE	2.4
1	H	105	LEU	2.4
1	E	284	MET	2.4
1	F	347	ASN	2.4
1	G	405	ALA	2.4
1	H	428	HIS	2.4
1	F	427	THR	2.4
1	D	11	TYR	2.4
1	J	434	ALA	2.4
1	C	422	ASP	2.4

*Continued on next page...*

*Continued from previous page...*

<b>Mol</b>	<b>Chain</b>	<b>Res</b>	<b>Type</b>	<b>RSRZ</b>
1	J	426	LYS	2.4
1	C	417	GLN	2.4
1	F	261	TRP	2.4
1	J	438	TRP	2.4
1	E	433	ARG	2.4
1	C	284	MET	2.4
1	J	427	THR	2.4
1	J	258	ILE	2.4
1	A	260	GLY	2.4
1	B	260	GLY	2.4
1	A	421	LEU	2.4
1	F	43	ALA	2.4
1	H	102	PRO	2.4
1	A	259	THR	2.4
1	A	254	VAL	2.4
1	G	18	GLU	2.4
1	J	256	VAL	2.4
1	H	318	ALA	2.3
1	A	16	GLY	2.3
1	G	375	ILE	2.3
1	B	109	ALA	2.3
1	B	421	LEU	2.3
1	G	153	LYS	2.3
1	H	256	VAL	2.3
1	H	440	HIS	2.3
1	H	377	PRO	2.3
1	E	425	ALA	2.3
1	G	81	GLY	2.3
1	G	103	GLY	2.3
1	H	426	LYS	2.3
1	G	392	GLY	2.2
1	F	440	HIS	2.2
1	G	218	ASN	2.2
1	F	109	ALA	2.2
1	F	419	ILE	2.2
1	J	259	THR	2.2
1	E	231	THR	2.2
1	E	287	ALA	2.2
1	E	439	GLY	2.2
1	I	106	ALA	2.2
1	J	413	ASP	2.2
1	F	284	MET	2.2

*Continued on next page...*

*Continued from previous page...*

<b>Mol</b>	<b>Chain</b>	<b>Res</b>	<b>Type</b>	<b>RSRZ</b>
1	C	424	TYR	2.2
1	B	433	ARG	2.2
1	C	256	VAL	2.2
1	E	105	LEU	2.2
1	E	395	LEU	2.2
1	I	101	LEU	2.2
1	D	284	MET	2.2
1	J	420	PRO	2.2
1	G	260	GLY	2.2
1	D	285	HIS	2.2
1	H	259	THR	2.2
1	I	56	THR	2.2
1	D	108	ILE	2.2
1	H	8	ILE	2.2
1	D	305	TYR	2.2
1	E	414	ALA	2.2
1	F	318	ALA	2.2
1	H	261	TRP	2.2
1	B	380	GLU	2.2
1	B	184	GLY	2.2
1	F	433	ARG	2.1
1	D	99	ALA	2.1
1	G	295	GLY	2.1
1	J	396	GLY	2.1
1	E	418	GLY	2.1
1	E	261	TRP	2.1
1	G	223	LYS	2.1
1	H	286	ALA	2.1
1	H	405	ALA	2.1
1	I	109	ALA	2.1
1	F	422	ASP	2.1
1	C	346	GLU	2.1
1	C	439	GLY	2.1
1	F	296	ILE	2.1
1	G	413	ASP	2.1
1	B	286	ALA	2.1
1	B	407	ALA	2.1
1	G	151	GLU	2.1
1	H	433	ARG	2.1
1	E	396	GLY	2.1
1	J	415	ILE	2.1
1	D	104	LEU	2.1

*Continued on next page...*



*Continued from previous page...*

Mol	Chain	Res	Type	RSRZ
1	B	430	GLU	2.1
1	E	259	THR	2.1
1	B	150	LEU	2.1
1	H	58	LEU	2.1
1	E	441	VAL	2.1
1	I	400	GLY	2.1
1	B	17	TYR	2.1
1	H	422	ASP	2.0
1	D	264	LEU	2.0
1	A	218	ASN	2.0
1	E	106	ALA	2.0
1	H	287	ALA	2.0
1	H	425	ALA	2.0
1	J	287	ALA	2.0
1	G	297	SER	2.0
1	I	288	PHE	2.0
1	A	110	GLY	2.0
1	G	286	ALA	2.0
1	E	397	HIS	2.0
1	E	438	TRP	2.0
1	B	373	GLY	2.0
1	A	422	ASP	2.0
1	D	286	ALA	2.0
1	E	109	ALA	2.0
1	I	99	ALA	2.0

## 6.2 Non-standard residues in protein, DNA, RNA chains [i](#)

In the following table, the Atoms column lists the number of modelled atoms in the group and the number defined in the chemical component dictionary. The B-factors column lists the minimum, median, 95<sup>th</sup> percentile and maximum values of B factors of atoms in the group. The column labelled 'Q< 0.9' lists the number of atoms with occupancy less than 0.9.

Mol	Type	Chain	Res	Atoms	RSCC	RSR	B-factors(Å <sup>2</sup> )	Q<0.9
1	KCX	F	189	12/13	0.95	0.18	42,43,44,46	0
1	KCX	I	189	12/13	0.96	0.15	26,27,28,29	0
1	KCX	J	189	12/13	0.96	0.10	37,38,39,39	0
1	KCX	G	189	12/13	0.97	0.12	48,49,50,51	0
1	KCX	H	189	12/13	0.97	0.10	48,49,51,52	0
1	KCX	E	189	12/13	0.97	0.12	38,40,41,41	0
1	KCX	B	189	12/13	0.97	0.12	48,49,50,51	0
1	KCX	A	189	12/13	0.98	0.14	34,35,36,36	0

*Continued on next page...*

*Continued from previous page...*

Mol	Type	Chain	Res	Atoms	RSCC	RSR	B-factors(Å <sup>2</sup> )	Q<0.9
1	KCX	C	189	12/13	0.98	0.11	39,41,42,42	0
1	KCX	D	189	12/13	0.98	0.15	30,31,32,33	0

### 6.3 Carbohydrates [i](#)

There are no monosaccharides in this entry.

### 6.4 Ligands [i](#)

In the following table, the Atoms column lists the number of modelled atoms in the group and the number defined in the chemical component dictionary. The B-factors column lists the minimum, median, 95<sup>th</sup> percentile and maximum values of B factors of atoms in the group. The column labelled 'Q< 0.9' lists the number of atoms with occupancy less than 0.9.

Mol	Type	Chain	Res	Atoms	RSCC	RSR	B-factors(Å <sup>2</sup> )	Q<0.9
4	EDO	J	503	4/4	0.58	0.27	32,32,33,33	0
4	EDO	A	503	4/4	0.71	0.14	62,62,63,64	0
4	EDO	E	503	4/4	0.76	0.18	42,43,44,44	0
4	EDO	I	504	4/4	0.79	0.17	48,48,49,50	0
2	MG	B	501	1/1	0.88	0.14	59,59,59,59	0
4	EDO	H	504	4/4	0.88	0.18	50,53,53,54	0
2	MG	J	501	1/1	0.90	0.16	43,43,43,43	0
2	MG	E	501	1/1	0.92	0.16	45,45,45,45	0
2	MG	H	501	1/1	0.93	0.18	58,58,58,58	0
3	CAP	J	502	21/21	0.94	0.15	41,47,53,54	0
3	CAP	B	502	21/21	0.95	0.14	55,59,65,66	0
3	CAP	E	502	21/21	0.95	0.14	45,50,57,58	0
3	CAP	G	502	21/21	0.95	0.15	52,56,62,62	0
4	EDO	I	503	4/4	0.95	0.15	26,26,26,28	0
3	CAP	H	502	21/21	0.95	0.13	56,60,67,68	0
2	MG	C	501	1/1	0.95	0.10	46,46,46,46	0
2	MG	F	501	1/1	0.96	0.13	46,46,46,46	0
2	MG	A	501	1/1	0.96	0.13	36,36,36,36	0
2	MG	I	501	1/1	0.96	0.12	28,28,28,28	0
3	CAP	F	502	21/21	0.96	0.14	49,53,56,57	0
4	EDO	D	503	4/4	0.96	0.14	28,28,29,30	0
3	CAP	I	502	21/21	0.97	0.14	31,33,35,36	0
4	EDO	H	503	4/4	0.97	0.17	29,29,30,32	0
2	MG	G	501	1/1	0.97	0.15	57,57,57,57	0
3	CAP	C	502	21/21	0.97	0.12	43,47,51,52	0
4	EDO	C	503	4/4	0.97	0.14	24,25,25,26	0

*Continued on next page...*

Continued from previous page...

Mol	Type	Chain	Res	Atoms	RSCC	RSR	B-factors( $\text{\AA}^2$ )	Q<0.9
3	CAP	A	502	21/21	0.97	0.12	37,39,42,43	0
4	EDO	B	503	4/4	0.98	0.13	31,31,31,33	0
3	CAP	D	502	21/21	0.98	0.14	32,35,38,39	0
2	MG	D	501	1/1	0.98	0.16	31,31,31,31	0

The following is a graphical depiction of the model fit to experimental electron density of all instances of the Ligand of Interest. In addition, ligands with molecular weight > 250 and outliers as shown on the geometry validation Tables will also be included. Each fit is shown from different orientation to approximate a three-dimensional view.

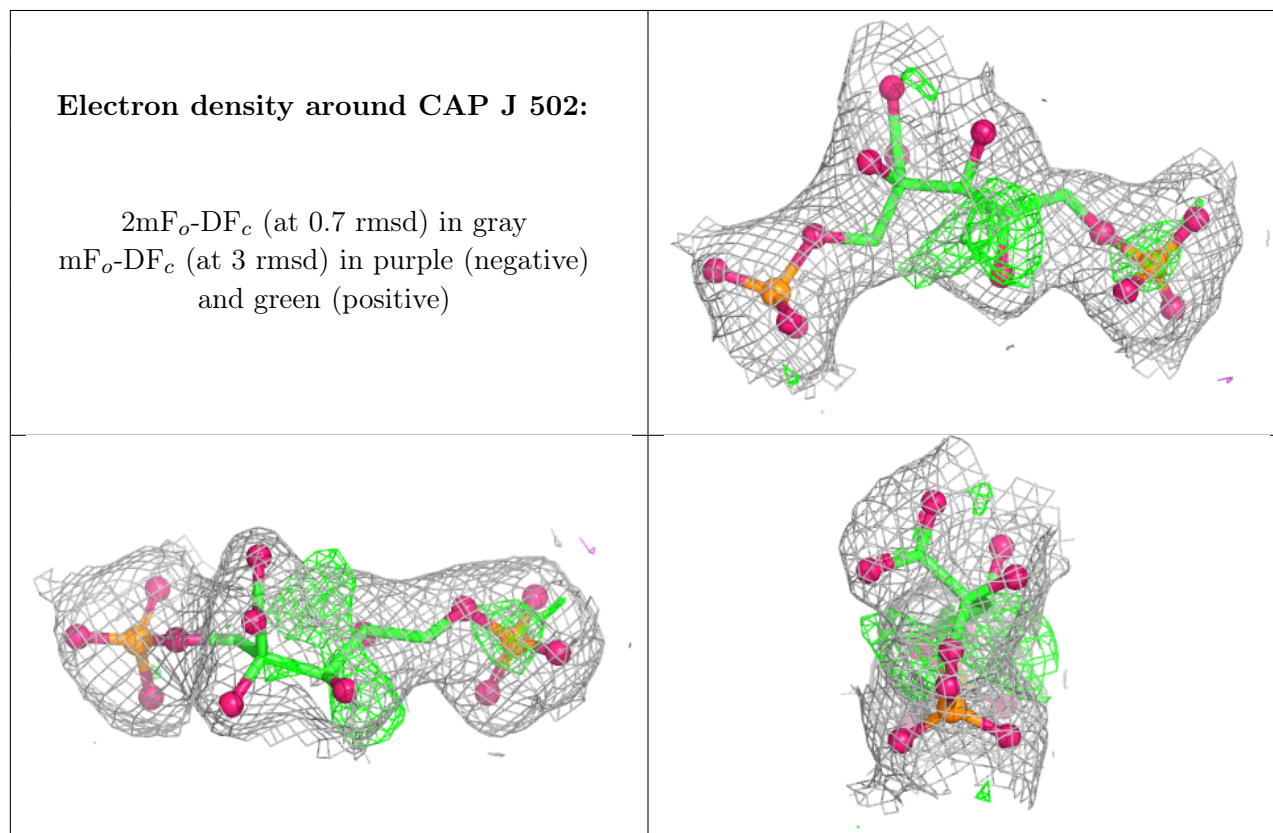

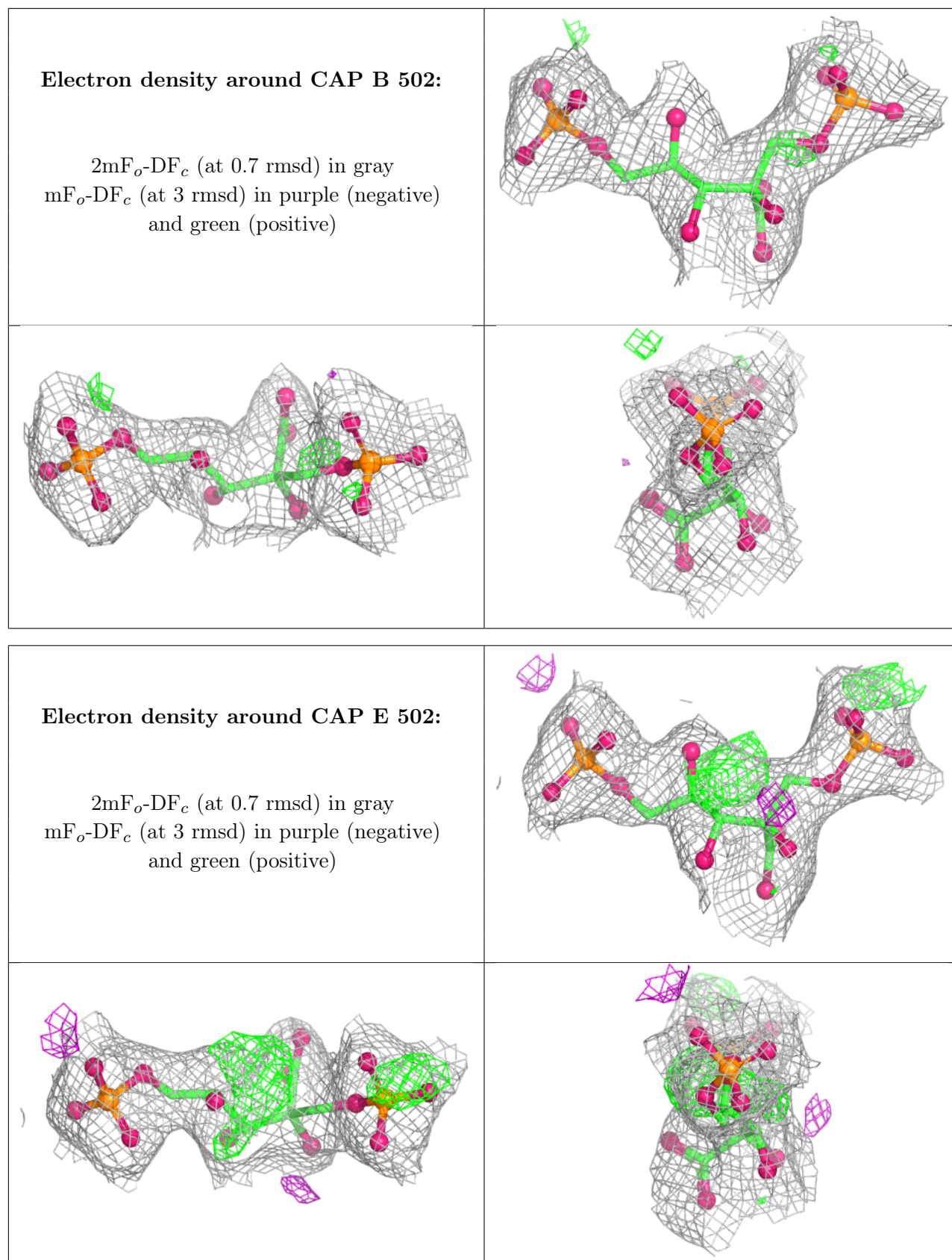

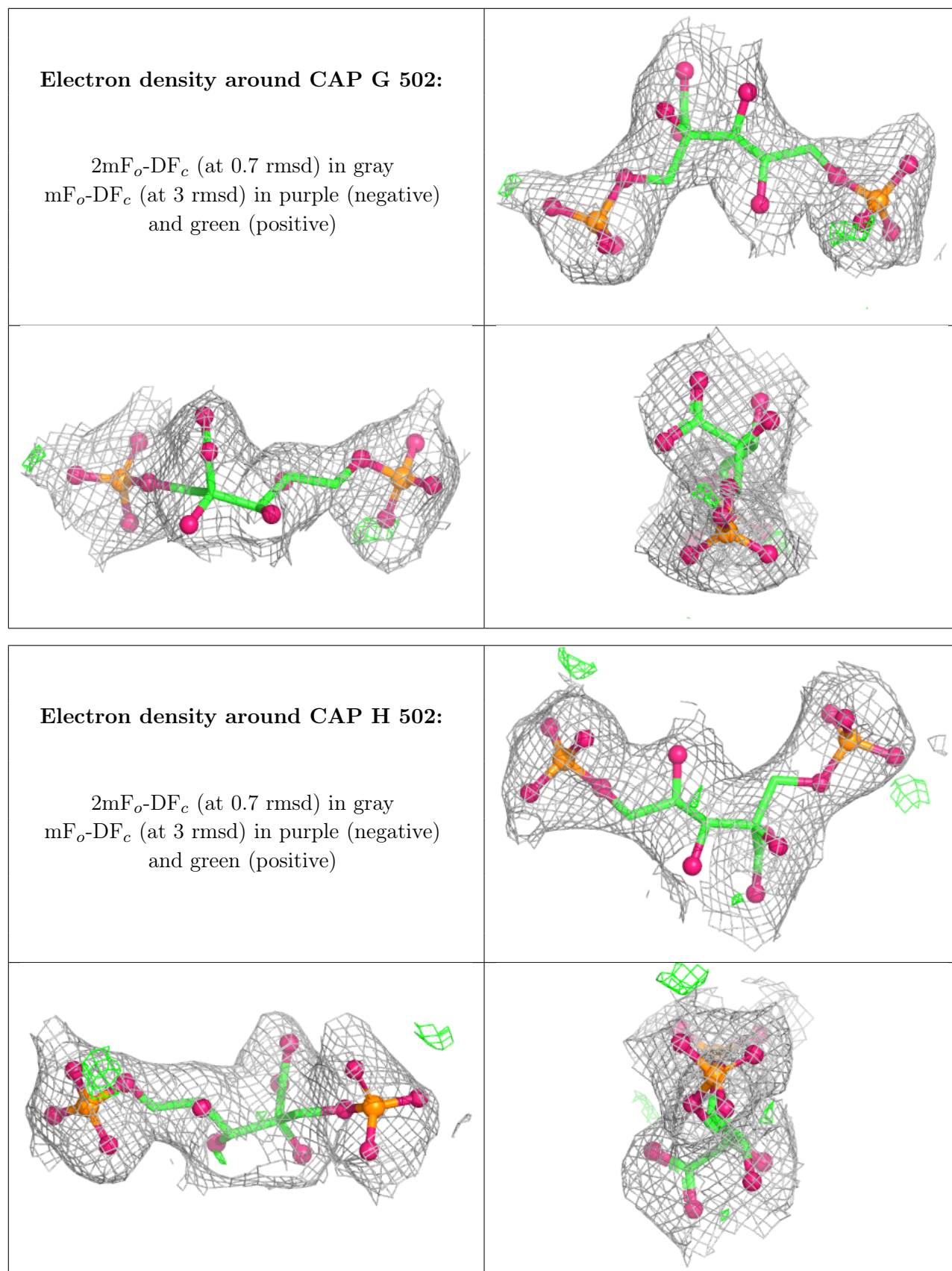

**Electron density around CAP F 502:**

$2mF_o-DF_c$  (at 0.7 rmsd) in gray  
 $mF_o-DF_c$  (at 3 rmsd) in purple (negative)  
and green (positive)

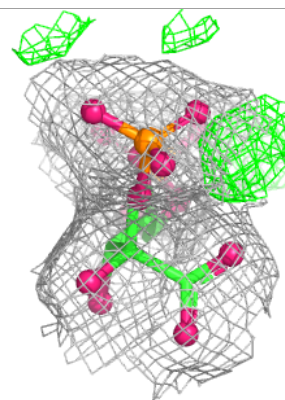
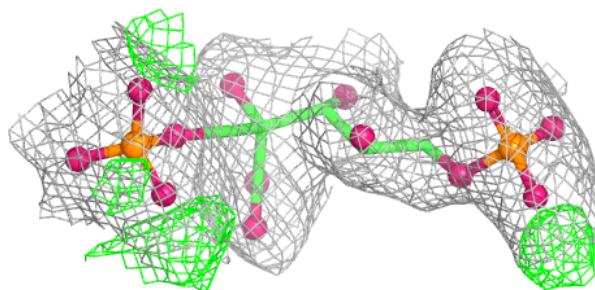
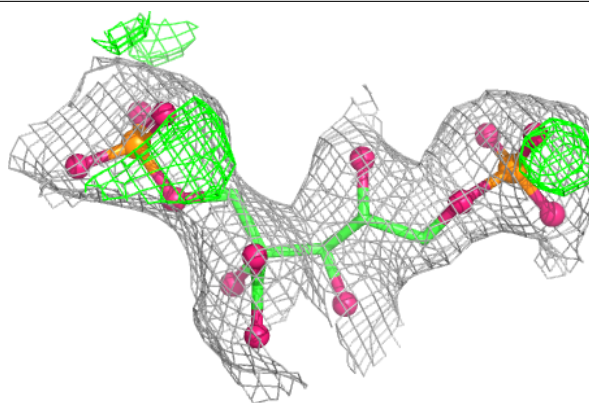
**Electron density around CAP I 502:**

$2mF_o-DF_c$  (at 0.7 rmsd) in gray  
 $mF_o-DF_c$  (at 3 rmsd) in purple (negative)  
and green (positive)

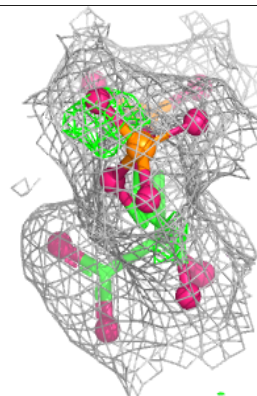
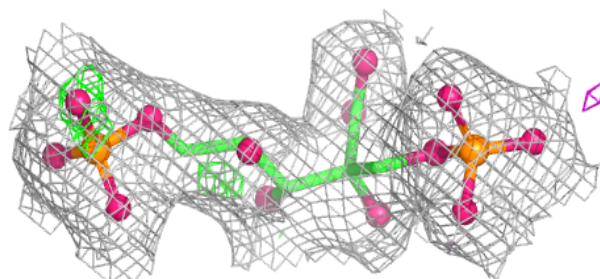
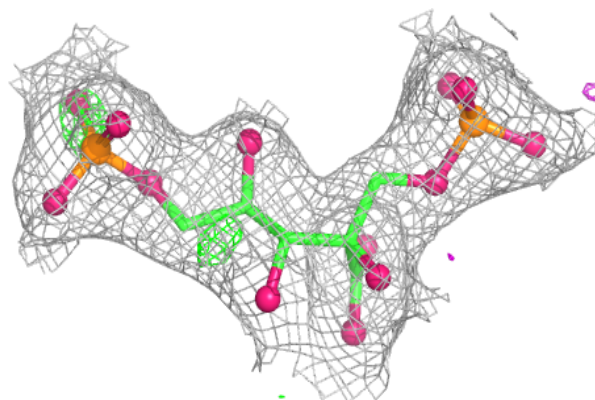

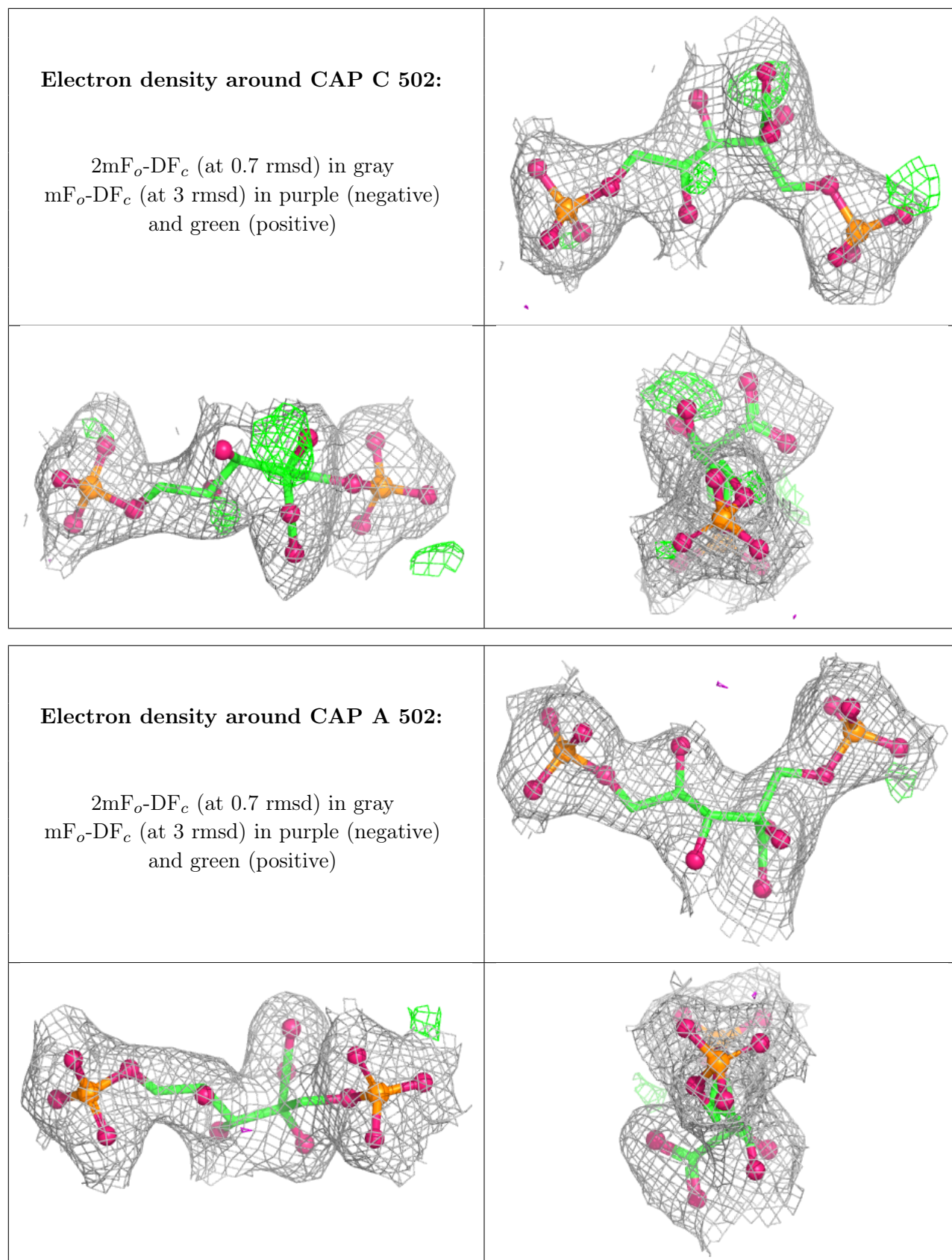

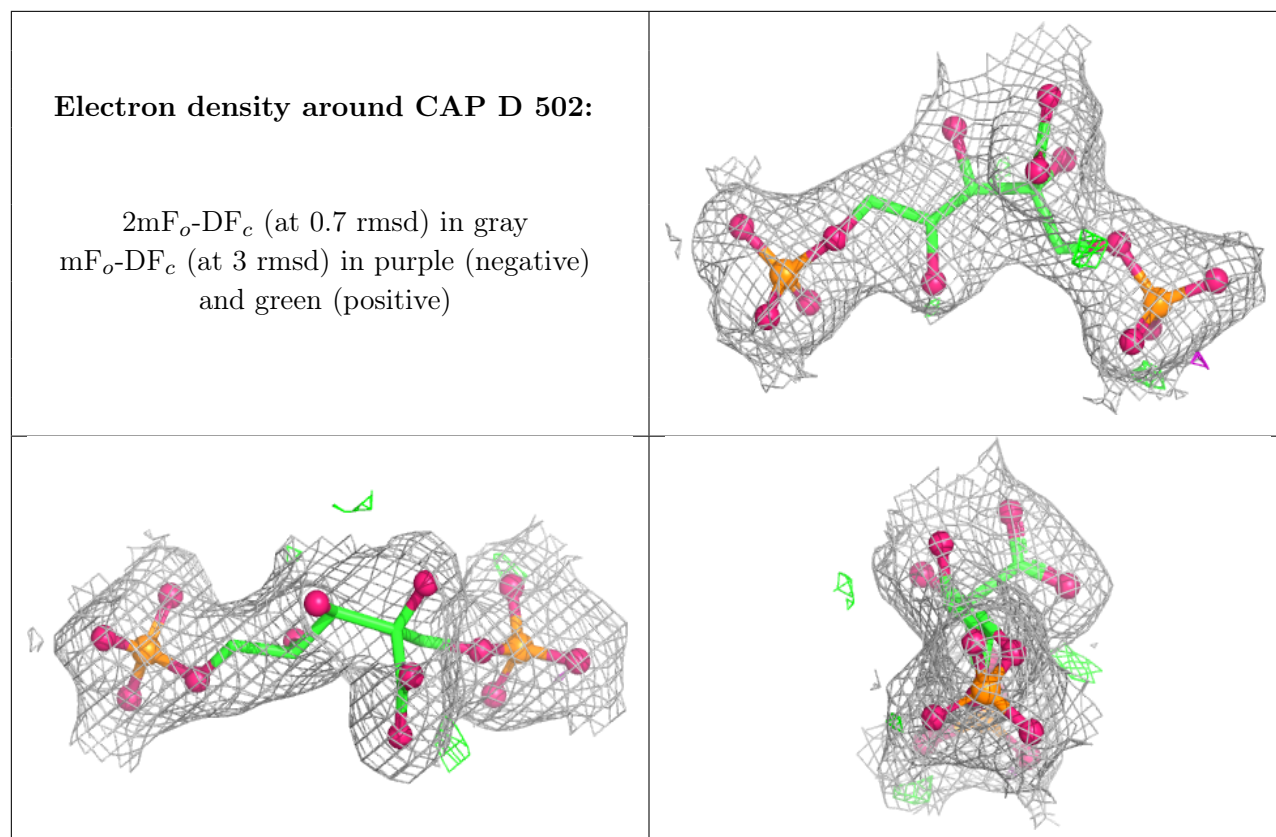

## 6.5 Other polymers [i](#)

There are no such residues in this entry.