



Full wwPDB X-ray Structure Validation Report ⓘ

Oct 31, 2023 – 01:54 PM EDT

PDB ID : 3TZ9
Title : Kinase domain of cSrc in complex with RL130
Authors : Gruetter, C.; Richters, A.; Rauh, D.
Deposited on : 2011-09-27
Resolution : 3.10 Å(reported)

This is a Full wwPDB X-ray Structure Validation Report for a publicly released PDB entry.

We welcome your comments at validation@mail.wwpdb.org

A user guide is available at

<https://www.wwpdb.org/validation/2017/XrayValidationReportHelp>

with specific help available everywhere you see the ⓘ symbol.

The types of validation reports are described at

<http://www.wwpdb.org/validation/2017/FAQs#types>.

The following versions of software and data (see [references ⓘ](#)) were used in the production of this report:

MolProbity : 4.02b-467
Mogul : 1.8.5 (274361), CSD as541be (2020)
Xtriage (Phenix) : 1.13
EDS : 2.36
buster-report : 1.1.7 (2018)
Percentile statistics : 20191225.v01 (using entries in the PDB archive December 25th 2019)
Refmac : 5.8.0158
CCP4 : 7.0.044 (Gargrove)
Ideal geometry (proteins) : Engh & Huber (2001)
Ideal geometry (DNA, RNA) : Parkinson et al. (1996)
Validation Pipeline (wwPDB-VP) : 2.36

1 Overall quality at a glance

The following experimental techniques were used to determine the structure:

X-RAY DIFFRACTION

The reported resolution of this entry is 3.10 Å.

Percentile scores (ranging between 0-100) for global validation metrics of the entry are shown in the following graphic. The table shows the number of entries on which the scores are based.

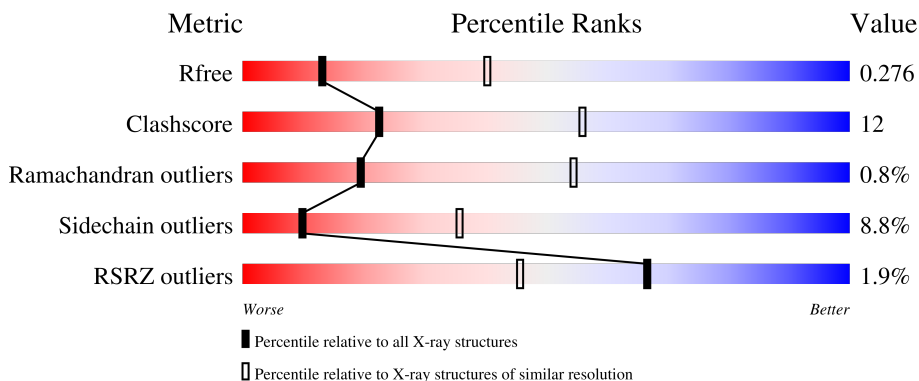

Metric	Whole archive (#Entries)	Similar resolution (#Entries, resolution range(Å))
R_{free}	130704	1094 (3.10-3.10)
Clashscore	141614	1184 (3.10-3.10)
Ramachandran outliers	138981	1141 (3.10-3.10)
Sidechain outliers	138945	1141 (3.10-3.10)
RSRZ outliers	127900	1067 (3.10-3.10)

The table below summarises the geometric issues observed across the polymeric chains and their fit to the electron density. The red, orange, yellow and green segments of the lower bar indicate the fraction of residues that contain outliers for ≥ 3 , 2, 1 and 0 types of geometric quality criteria respectively. A grey segment represents the fraction of residues that are not modelled. The numeric value for each fraction is indicated below the corresponding segment, with a dot representing fractions $\leq 5\%$. The upper red bar (where present) indicates the fraction of residues that have poor fit to the electron density. The numeric value is given above the bar.

Mol	Chain	Length	Quality of chain
1	A	286	
1	B	286	

2 Entry composition

There are 2 unique types of molecules in this entry. The entry contains 4268 atoms, of which 0 are hydrogens and 0 are deuteriums.

In the tables below, the ZeroOcc column contains the number of atoms modelled with zero occupancy, the AltConf column contains the number of residues with at least one atom in alternate conformation and the Trace column contains the number of residues modelled with at most 2 atoms.

- Molecule 1 is a protein called Proto-oncogene tyrosine-protein kinase Src.

Mol	Chain	Residues	Atoms					ZeroOcc	AltConf	Trace
			Total	C	N	O	S			
1	A	261	2103	1351	350	384	18	0	0	0
1	B	259	2091	1343	348	382	18	0	0	0

There are 8 discrepancies between the modelled and reference sequences:

Chain	Residue	Modelled	Actual	Comment	Reference
A	248	GLY	-	EXPRESSION TAG	UNP P00523
A	249	HIS	-	EXPRESSION TAG	UNP P00523
A	250	MET	-	EXPRESSION TAG	UNP P00523
A	345	CYS	SER	ENGINEERED MUTATION	UNP P00523
B	248	GLY	-	EXPRESSION TAG	UNP P00523
B	249	HIS	-	EXPRESSION TAG	UNP P00523
B	250	MET	-	EXPRESSION TAG	UNP P00523
B	345	CYS	SER	ENGINEERED MUTATION	UNP P00523

- Molecule 2 is 1-[1-(3-aminophenyl)-3-tert-butyl-1H-pyrazol-5-yl]-3-[4-(quinazolin-4-ylamino)phenyl]urea (three-letter code: AQU) (formula: C₂₈H₂₈N₈O).

3 Residue-property plots [i](#)

These plots are drawn for all protein, RNA, DNA and oligosaccharide chains in the entry. The first graphic for a chain summarises the proportions of the various outlier classes displayed in the second graphic. The second graphic shows the sequence view annotated by issues in geometry and electron density. Residues are color-coded according to the number of geometric quality criteria for which they contain at least one outlier: green = 0, yellow = 1, orange = 2 and red = 3 or more. A red dot above a residue indicates a poor fit to the electron density ($RSRZ > 2$). Stretches of 2 or more consecutive residues without any outlier are shown as a green connector. Residues present in the sample, but not in the model, are shown in grey.

- Molecule 1: Proto-oncogene tyrosine-protein kinase Src

Chain A: 

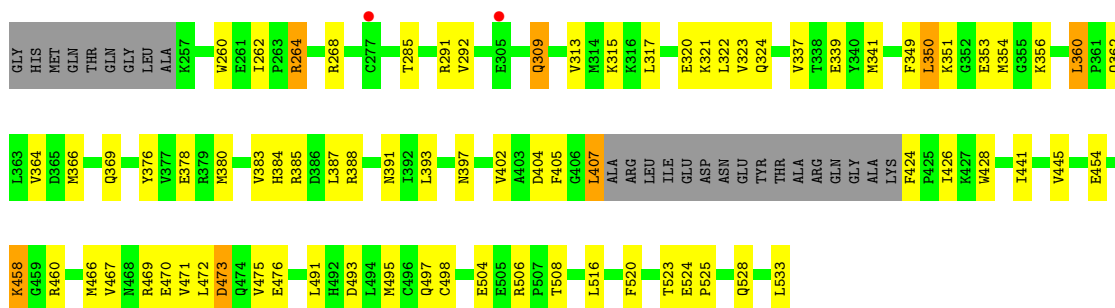

- Molecule 1: Proto-oncogene tyrosine-protein kinase Src

Chain B: 

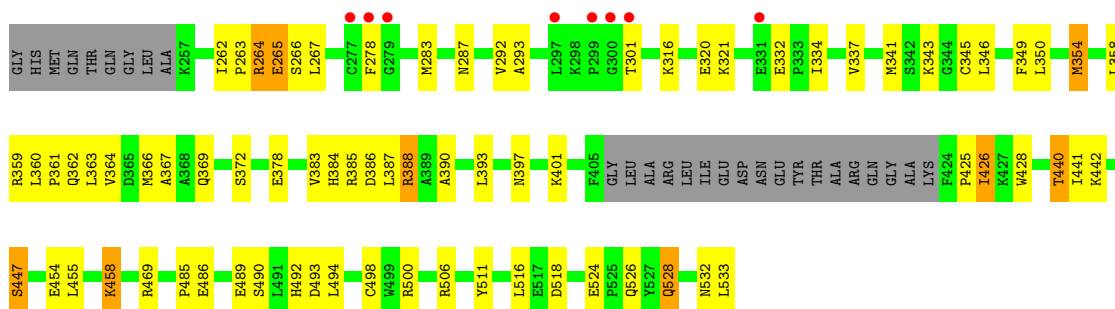

4 Data and refinement statistics i

Property	Value	Source
Space group	P 1	Depositor
Cell constants a, b, c, α , β , γ	42.02Å 63.42Å 74.20Å 79.60° 87.89° 89.98°	Depositor
Resolution (Å)	41.99 – 3.10 41.99 – 3.10	Depositor EDS
% Data completeness (in resolution range)	100.0 (41.99-3.10) 91.9 (41.99-3.10)	Depositor EDS
R_{merge}	0.06	Depositor
R_{sym}	(Not available)	Depositor
$\langle I/\sigma(I) \rangle$ ¹	3.95 (at 3.12Å)	Xtrriage
Refinement program	REFMAC	Depositor
R, R_{free}	0.211 , 0.283 0.209 , 0.276	Depositor DCC
R_{free} test set	815 reflections (6.50%)	wwPDB-VP
Wilson B-factor (Å ²)	56.0	Xtrriage
Anisotropy	0.458	Xtrriage
Bulk solvent k_{sol} (e/Å ³), B_{sol} (Å ²)	0.34 , 50.5	EDS
L-test for twinning ²	$\langle L \rangle = 0.49$, $\langle L^2 \rangle = 0.32$	Xtrriage
Estimated twinning fraction	0.037 for h,-k,-l	Xtrriage
F_o, F_c correlation	0.92	EDS
Total number of atoms	4268	wwPDB-VP
Average B, all atoms (Å ²)	53.0	wwPDB-VP

Xtrriage's analysis on translational NCS is as follows: *The largest off-origin peak in the Patterson function is 12.69% of the height of the origin peak. No significant pseudotranslation is detected.*

¹Intensities estimated from amplitudes.

²Theoretical values of $\langle |L| \rangle$, $\langle L^2 \rangle$ for acentric reflections are 0.5, 0.333 respectively for untwinned datasets, and 0.375, 0.2 for perfectly twinned datasets.

5 Model quality

5.1 Standard geometry

Bond lengths and bond angles in the following residue types are not validated in this section: AQU

The Z score for a bond length (or angle) is the number of standard deviations the observed value is removed from the expected value. A bond length (or angle) with $|Z| > 5$ is considered an outlier worth inspection. RMSZ is the root-mean-square of all Z scores of the bond lengths (or angles).

Mol	Chain	Bond lengths		Bond angles	
		RMSZ	# Z >5	RMSZ	# Z >5
1	A	0.58	0/2155	0.66	0/2917
1	B	0.57	0/2143	0.66	0/2901
All	All	0.57	0/4298	0.66	0/5818

There are no bond length outliers.

There are no bond angle outliers.

There are no chirality outliers.

There are no planarity outliers.

5.2 Too-close contacts

In the following table, the Non-H and H(model) columns list the number of non-hydrogen atoms and hydrogen atoms in the chain respectively. The H(added) column lists the number of hydrogen atoms added and optimized by MolProbity. The Clashes column lists the number of clashes within the asymmetric unit, whereas Symm-Clashes lists symmetry-related clashes.

Mol	Chain	Non-H	H(model)	H(added)	Clashes	Symm-Clashes
1	A	2103	0	2089	39	0
1	B	2091	0	2075	59	0
2	A	37	0	28	5	0
2	B	37	0	28	2	0
All	All	4268	0	4220	98	0

The all-atom clashscore is defined as the number of clashes found per 1000 atoms (including hydrogen atoms). The all-atom clashscore for this structure is 12.

All (98) close contacts within the same asymmetric unit are listed below, sorted by their clash magnitude.

Atom-1	Atom-2	Interatomic distance (Å)	Clash overlap (Å)
1:B:264:ARG:HG2	1:B:264:ARG:HH11	1.28	0.98
1:B:262:ILE:HB	1:B:263:PRO:HD2	1.66	0.77
1:A:260:TRP:CD1	1:A:315:LYS:HE2	2.20	0.76
1:B:264:ARG:HH11	1:B:264:ARG:CG	2.00	0.73
1:A:426:ILE:HD11	1:A:472:LEU:HD13	1.70	0.71
1:B:442:LYS:NZ	1:B:506:ARG:O	2.19	0.70
1:B:343:LYS:HE2	1:B:349:PHE:HE1	1.58	0.69
1:B:498:CYS:O	1:B:506:ARG:HD2	1.94	0.68
1:A:391:ASN:OD1	1:A:407:LEU:HD11	1.95	0.66
1:B:500:ARG:O	1:B:506:ARG:NH1	2.29	0.65
1:B:362:GLN:O	1:B:366:MET:HG3	1.97	0.64
1:B:292:VAL:HG11	1:B:337:VAL:HG13	1.79	0.63
1:B:500:ARG:HB2	1:B:506:ARG:HG2	1.81	0.62
1:B:320:GLU:O	1:B:401:LYS:HE2	2.00	0.61
1:A:466:MET:HE3	1:A:471:VAL:HG22	1.82	0.61
1:A:428:TRP:HE1	1:A:454:GLU:CD	2.05	0.60
1:A:491:LEU:O	1:A:495:MET:HG3	2.01	0.60
1:A:387:LEU:O	1:A:388:ARG:HB3	2.03	0.59
1:B:292:VAL:CG1	1:B:337:VAL:HG13	2.33	0.59
1:B:343:LYS:HE2	1:B:349:PHE:CE1	2.38	0.58
1:B:369:GLN:O	1:B:372:SER:HB3	2.04	0.57
1:A:322:LEU:HD22	2:A:1:AQU:HACA	1.86	0.57
1:A:362:GLN:O	1:A:366:MET:HG3	2.04	0.57
1:A:498:CYS:O	1:A:506:ARG:HD3	2.04	0.57
1:B:264:ARG:HG2	1:B:264:ARG:NH1	2.08	0.57
1:B:346:LEU:HD21	1:B:455:LEU:HD21	1.86	0.57
1:B:360:LEU:HB3	1:B:361:PRO:CD	2.34	0.57
1:B:440:THR:HB	1:B:442:LYS:H	1.72	0.54
2:B:1:AQU:HAL	2:B:1:AQU:OAE	2.07	0.54
1:B:264:ARG:CG	1:B:264:ARG:NH1	2.64	0.54
1:A:384:HIS:O	1:A:385:ARG:HB2	2.07	0.54
1:B:384:HIS:O	1:B:385:ARG:HB2	2.07	0.54
1:A:350:LEU:HG	1:A:458:LYS:HA	1.89	0.54
1:A:292:VAL:HG13	1:A:337:VAL:HG13	1.90	0.53
1:A:320:GLU:HG3	1:A:321:LYS:HG2	1.91	0.53
1:B:341:MET:HG3	1:B:393:LEU:HB3	1.89	0.53
1:B:262:ILE:HB	1:B:263:PRO:CD	2.38	0.53
1:B:321:LYS:HD2	1:B:369:GLN:HB3	1.92	0.52
1:B:360:LEU:HB3	1:B:361:PRO:HD3	1.90	0.52
1:B:426:ILE:HG12	1:B:426:ILE:O	2.07	0.52
1:B:498:CYS:O	1:B:506:ARG:CD	2.57	0.52
1:A:383:VAL:HG12	1:A:385:ARG:HG3	1.92	0.52

Continued on next page...

Continued from previous page...

Atom-1	Atom-2	Interatomic distance (Å)	Clash overlap (Å)
1:B:378:GLU:HG3	1:B:441:ILE:HG12	1.93	0.51
1:A:321:LYS:HD2	1:A:369:GLN:HB3	1.94	0.50
1:B:528:GLN:HA	1:B:528:GLN:HE21	1.75	0.50
1:A:360:LEU:HD23	1:A:533:LEU:HD22	1.93	0.50
1:B:363:LEU:HD13	1:B:455:LEU:O	2.12	0.50
1:B:358:LEU:O	1:B:458:LYS:NZ	2.45	0.50
1:B:292:VAL:CG1	1:B:293:ALA:N	2.75	0.49
1:B:486:GLU:OE1	1:B:532:ASN:HB2	2.12	0.49
1:A:520:PHE:O	1:A:525:PRO:HA	2.13	0.49
1:B:332:GLU:OE1	1:B:334:ILE:HG12	2.13	0.48
1:A:493:ASP:O	1:A:497:GLN:HG3	2.14	0.48
1:B:266:SER:HB2	1:B:287:ASN:OD1	2.14	0.48
1:B:278:PHE:HB3	1:B:301:THR:HB	1.95	0.48
1:B:350:LEU:HG	1:B:458:LYS:HA	1.94	0.48
1:B:278:PHE:CD1	1:B:301:THR:HB	2.51	0.46
1:A:309:GLN:O	1:A:313:VAL:HG23	2.15	0.46
1:A:441:ILE:O	1:A:445:VAL:HG23	2.16	0.46
1:B:343:LYS:HZ1	1:B:354:MET:HE2	1.81	0.46
1:A:405:PHE:HA	2:A:1:AQU:HAL	1.98	0.46
1:B:485:PRO:O	1:B:486:GLU:HB2	2.17	0.45
1:B:350:LEU:HD21	1:B:455:LEU:HA	1.98	0.45
1:A:364:VAL:HG13	1:A:516:LEU:HD22	1.99	0.45
2:B:1:AQU:OAE	2:B:1:AQU:CAL	2.65	0.44
1:A:321:LYS:NZ	1:A:369:GLN:OE1	2.37	0.44
1:B:292:VAL:HG13	1:B:293:ALA:N	2.33	0.44
1:B:384:HIS:CE1	1:B:386:ASP:O	2.71	0.44
1:A:341:MET:HG3	1:A:393:LEU:HB3	2.00	0.44
1:B:267:LEU:O	1:B:267:LEU:HD12	2.18	0.44
1:B:388:ARG:HB2	1:B:428:TRP:CD1	2.53	0.43
1:B:359:ARG:HD3	1:B:533:LEU:O	2.18	0.43
1:A:376:TYR:O	1:A:380:MET:HG2	2.18	0.43
1:B:292:VAL:HG11	1:B:337:VAL:CG1	2.48	0.43
1:A:317:LEU:HD12	2:A:1:AQU:HAAA	2.00	0.43
1:A:264:ARG:H	1:A:264:ARG:HG2	1.62	0.43
1:A:339:GLU:O	2:A:1:AQU:H2	2.19	0.42
1:A:351:LYS:O	1:B:511:TYR:HE1	2.02	0.42
1:A:349:PHE:CE1	1:A:354:MET:HG3	2.55	0.42
1:B:383:VAL:HG12	1:B:385:ARG:HG3	2.01	0.42
1:B:364:VAL:HG13	1:B:516:LEU:HD22	2.02	0.42
1:A:349:PHE:HE1	1:A:354:MET:HG3	1.83	0.42
1:B:343:LYS:NZ	1:B:354:MET:CE	2.83	0.42

Continued on next page...

Continued from previous page...

Atom-1	Atom-2	Interatomic distance (Å)	Clash overlap (Å)
1:A:378:GLU:HG3	1:A:441:ILE:HG12	2.02	0.42
1:A:404:ASP:O	2:A:1:AQU:CAZ	2.68	0.42
1:B:321:LYS:HD3	1:B:321:LYS:HA	1.82	0.42
1:B:387:LEU:HD23	1:B:447:SER:HB2	2.02	0.42
1:A:322:LEU:HD23	1:A:402:VAL:HB	2.01	0.41
1:A:460:ARG:NH1	1:B:518:ASP:CG	2.73	0.41
1:A:384:HIS:O	1:A:385:ARG:CB	2.68	0.41
1:A:469:ARG:O	1:A:473:ASP:OD1	2.38	0.41
1:B:489:GLU:O	1:B:492:HIS:N	2.54	0.41
1:B:528:GLN:HA	1:B:528:GLN:NE2	2.36	0.41
1:B:367:ALA:HB2	1:B:455:LEU:HD12	2.03	0.41
1:B:493:ASP:O	1:B:494:LEU:C	2.59	0.41
1:B:386:ASP:OD2	1:B:388:ARG:NH2	2.54	0.40
1:A:467:VAL:O	1:A:470:GLU:HB3	2.21	0.40
1:B:388:ARG:HH11	1:B:390:ALA:HB3	1.87	0.40

There are no symmetry-related clashes.

5.3 Torsion angles [i](#)

5.3.1 Protein backbone [i](#)

In the following table, the Percentiles column shows the percent Ramachandran outliers of the chain as a percentile score with respect to all X-ray entries followed by that with respect to entries of similar resolution.

The Analysed column shows the number of residues for which the backbone conformation was analysed, and the total number of residues.

Mol	Chain	Analysed	Favoured	Allowed	Outliers	Percentiles	
1	A	257/286 (90%)	226 (88%)	30 (12%)	1 (0%)	34	69
1	B	255/286 (89%)	229 (90%)	23 (9%)	3 (1%)	13	44
All	All	512/572 (90%)	455 (89%)	53 (10%)	4 (1%)	19	54

All (4) Ramachandran outliers are listed below:

Mol	Chain	Res	Type
1	B	265	GLU
1	B	425	PRO
1	A	353	GLU

Continued on next page...

Continued from previous page...

Mol	Chain	Res	Type
1	B	490	SER

5.3.2 Protein sidechains [i](#)

In the following table, the Percentiles column shows the percent sidechain outliers of the chain as a percentile score with respect to all X-ray entries followed by that with respect to entries of similar resolution.

The Analysed column shows the number of residues for which the sidechain conformation was analysed, and the total number of residues.

Mol	Chain	Analysed	Rotameric	Outliers	Percentiles	
1	A	227/245 (93%)	204 (90%)	23 (10%)	7	28
1	B	226/245 (92%)	209 (92%)	17 (8%)	13	42
All	All	453/490 (92%)	413 (91%)	40 (9%)	10	36

All (40) residues with a non-rotameric sidechain are listed below:

Mol	Chain	Res	Type
1	A	262	ILE
1	A	264	ARG
1	A	268	ARG
1	A	285	THR
1	A	291	ARG
1	A	309	GLN
1	A	323	VAL
1	A	324	GLN
1	A	350	LEU
1	A	356	LYS
1	A	360	LEU
1	A	397	ASN
1	A	407	LEU
1	A	424	PHE
1	A	458	LYS
1	A	473	ASP
1	A	475	VAL
1	A	476	GLU
1	A	504	GLU
1	A	508	THR
1	A	523	THR
1	A	524	GLU

Continued on next page...

Continued from previous page...

Mol	Chain	Res	Type
1	A	528	GLN
1	B	264	ARG
1	B	265	GLU
1	B	283	MET
1	B	316	LYS
1	B	345	CYS
1	B	354	MET
1	B	388	ARG
1	B	397	ASN
1	B	426	ILE
1	B	440	THR
1	B	447	SER
1	B	454	GLU
1	B	458	LYS
1	B	469	ARG
1	B	524	GLU
1	B	526	GLN
1	B	528	GLN

Sometimes sidechains can be flipped to improve hydrogen bonding and reduce clashes. All (5) such sidechains are listed below:

Mol	Chain	Res	Type
1	A	397	ASN
1	B	309	GLN
1	B	397	ASN
1	B	513	GLN
1	B	528	GLN

5.3.3 RNA [i](#)

There are no RNA molecules in this entry.

5.4 Non-standard residues in protein, DNA, RNA chains [i](#)

There are no non-standard protein/DNA/RNA residues in this entry.

5.5 Carbohydrates [i](#)

There are no monosaccharides in this entry.

5.6 Ligand geometry

2 ligands are modelled in this entry.

In the following table, the Counts columns list the number of bonds (or angles) for which Mogul statistics could be retrieved, the number of bonds (or angles) that are observed in the model and the number of bonds (or angles) that are defined in the Chemical Component Dictionary. The Link column lists molecule types, if any, to which the group is linked. The Z score for a bond length (or angle) is the number of standard deviations the observed value is removed from the expected value. A bond length (or angle) with $|Z| > 2$ is considered an outlier worth inspection. RMSZ is the root-mean-square of all Z scores of the bond lengths (or angles).

Mol	Type	Chain	Res	Link	Bond lengths			Bond angles		
					Counts	RMSZ	# Z > 2	Counts	RMSZ	# Z > 2
2	AQU	B	1	-	41,41,41	2.23	9 (21%)	52,59,59	1.90	14 (26%)
2	AQU	A	1	-	41,41,41	2.22	12 (29%)	52,59,59	2.09	14 (26%)

In the following table, the Chirals column lists the number of chiral outliers, the number of chiral centers analysed, the number of these observed in the model and the number defined in the Chemical Component Dictionary. Similar counts are reported in the Torsion and Rings columns. '-' means no outliers of that kind were identified.

Mol	Type	Chain	Res	Link	Chirals	Torsions	Rings
2	AQU	B	1	-	-	2/20/22/22	0/5/5/5
2	AQU	A	1	-	-	4/20/22/22	0/5/5/5

All (21) bond length outliers are listed below:

Mol	Chain	Res	Type	Atoms	Z	Observed(Å)	Ideal(Å)
2	B	1	AQU	NAV-NBJ	-7.45	1.24	1.39
2	A	1	AQU	C2-N3	6.12	1.42	1.32
2	B	1	AQU	C2-N3	6.04	1.41	1.32
2	B	1	AQU	CAS-CBE	-4.77	1.33	1.39
2	A	1	AQU	NAV-NBJ	-4.74	1.30	1.39
2	A	1	AQU	CAS-CBE	-4.60	1.33	1.39
2	A	1	AQU	CBB-NAW	-4.42	1.32	1.41
2	B	1	AQU	C2-N1	4.37	1.42	1.33
2	A	1	AQU	C2-N1	4.08	1.41	1.33
2	A	1	AQU	C6-C5	-3.87	1.40	1.44
2	A	1	AQU	CBC-NAY	-3.20	1.33	1.40
2	B	1	AQU	CBB-NAW	-3.14	1.35	1.41
2	B	1	AQU	CBD-NBJ	-3.13	1.34	1.44
2	B	1	AQU	CBC-NAY	-3.07	1.33	1.40
2	A	1	AQU	CBF-NAX	-3.05	1.33	1.39

Continued on next page...

Continued from previous page...

Mol	Chain	Res	Type	Atoms	Z	Observed(Å)	Ideal(Å)
2	B	1	AQU	C6-C5	-3.01	1.41	1.44
2	A	1	AQU	CBD-NBJ	-2.90	1.35	1.44
2	A	1	AQU	CBF-NBJ	-2.86	1.34	1.37
2	B	1	AQU	CBF-NAX	-2.33	1.35	1.39
2	A	1	AQU	CBK-CBE	2.06	1.55	1.52
2	A	1	AQU	CAR-CBD	2.04	1.41	1.38

All (28) bond angle outliers are listed below:

Mol	Chain	Res	Type	Atoms	Z	Observed(°)	Ideal(°)
2	B	1	AQU	C6-C5-C4	6.35	119.88	115.88
2	A	1	AQU	N3-C2-N1	-5.84	119.55	128.68
2	A	1	AQU	C6-C5-C4	5.73	119.48	115.88
2	B	1	AQU	N3-C2-N1	-5.25	120.47	128.68
2	A	1	AQU	C5-C6-NAY	-5.13	114.08	119.73
2	A	1	AQU	CBK-CBE-NAV	4.69	125.64	120.59
2	A	1	AQU	NAY-C6-N1	4.28	124.45	118.72
2	A	1	AQU	C2-N3-C4	3.58	120.33	115.40
2	B	1	AQU	CBK-CBE-NAV	3.53	124.38	120.59
2	A	1	AQU	CAQ-C5-C6	-3.27	119.57	124.06
2	B	1	AQU	NAY-C6-N1	3.21	123.03	118.72
2	B	1	AQU	C5-C6-NAY	-3.19	116.22	119.73
2	B	1	AQU	C2-N3-C4	3.08	119.65	115.40
2	A	1	AQU	CAS-CBE-CBK	-3.05	125.10	129.07
2	A	1	AQU	C2-N1-C6	2.77	118.97	116.59
2	B	1	AQU	CBC-NAY-C6	-2.76	121.06	128.26
2	B	1	AQU	C2-N1-C6	2.74	118.94	116.59
2	B	1	AQU	CAS-CBE-CBK	-2.67	125.59	129.07
2	B	1	AQU	CBE-CAS-CBF	-2.65	103.84	106.59
2	B	1	AQU	CAQ-C5-C6	-2.62	120.46	124.06
2	A	1	AQU	CBC-NAY-C6	-2.53	121.67	128.26
2	A	1	AQU	CAK-CBD-CAR	-2.48	118.80	121.74
2	B	1	AQU	CBE-NAV-NBJ	2.48	108.53	105.66
2	A	1	AQU	C5-C4-N3	-2.47	120.20	122.83
2	B	1	AQU	C5-C4-N3	-2.38	120.30	122.83
2	A	1	AQU	CBE-NAV-NBJ	2.38	108.42	105.66
2	A	1	AQU	CAQ-C5-C4	2.34	120.94	118.33
2	B	1	AQU	CBD-NBJ-CBF	-2.26	126.43	129.11

There are no chirality outliers.

All (6) torsion outliers are listed below:

Mol	Chain	Res	Type	Atoms
2	A	1	AQU	CAL-CBB-NAW-CAZ
2	A	1	AQU	CAM-CBB-NAW-CAZ
2	B	1	AQU	CAN-CBC-NAY-C6
2	B	1	AQU	CAO-CBC-NAY-C6
2	A	1	AQU	CAN-CBC-NAY-C6
2	A	1	AQU	CAO-CBC-NAY-C6

There are no ring outliers.

2 monomers are involved in 7 short contacts:

Mol	Chain	Res	Type	Clashes	Symm-Clashes
2	B	1	AQU	2	0
2	A	1	AQU	5	0

The following is a two-dimensional graphical depiction of Mogul quality analysis of bond lengths, bond angles, torsion angles, and ring geometry for all instances of the Ligand of Interest. In addition, ligands with molecular weight > 250 and outliers as shown on the validation Tables will also be included. For torsion angles, if less than 5% of the Mogul distribution of torsion angles is within 10 degrees of the torsion angle in question, then that torsion angle is considered an outlier. Any bond that is central to one or more torsion angles identified as an outlier by Mogul will be highlighted in the graph. For rings, the root-mean-square deviation (RMSD) between the ring in question and similar rings identified by Mogul is calculated over all ring torsion angles. If the average RMSD is greater than 60 degrees and the minimal RMSD between the ring in question and any Mogul-identified rings is also greater than 60 degrees, then that ring is considered an outlier. The outliers are highlighted in purple. The color gray indicates Mogul did not find sufficient equivalents in the CSD to analyse the geometry.

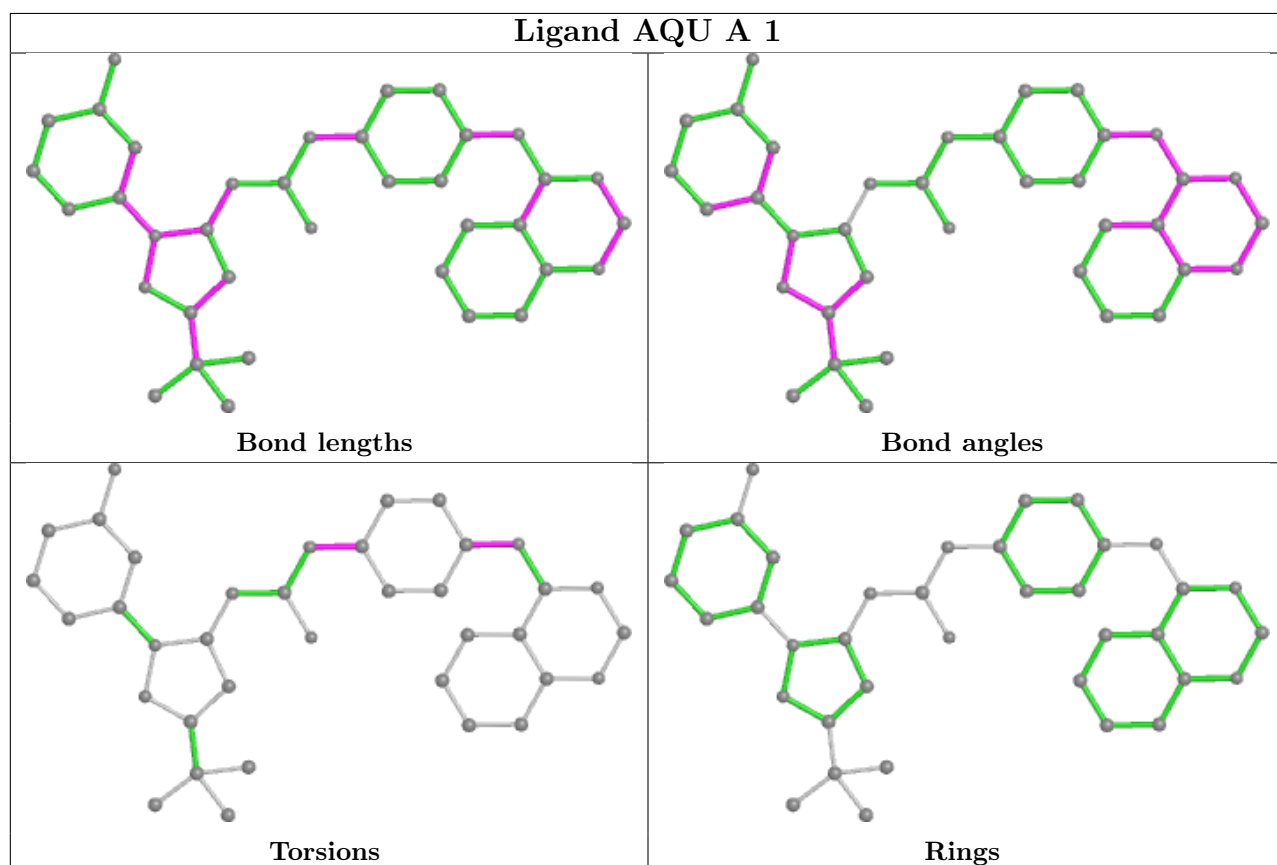
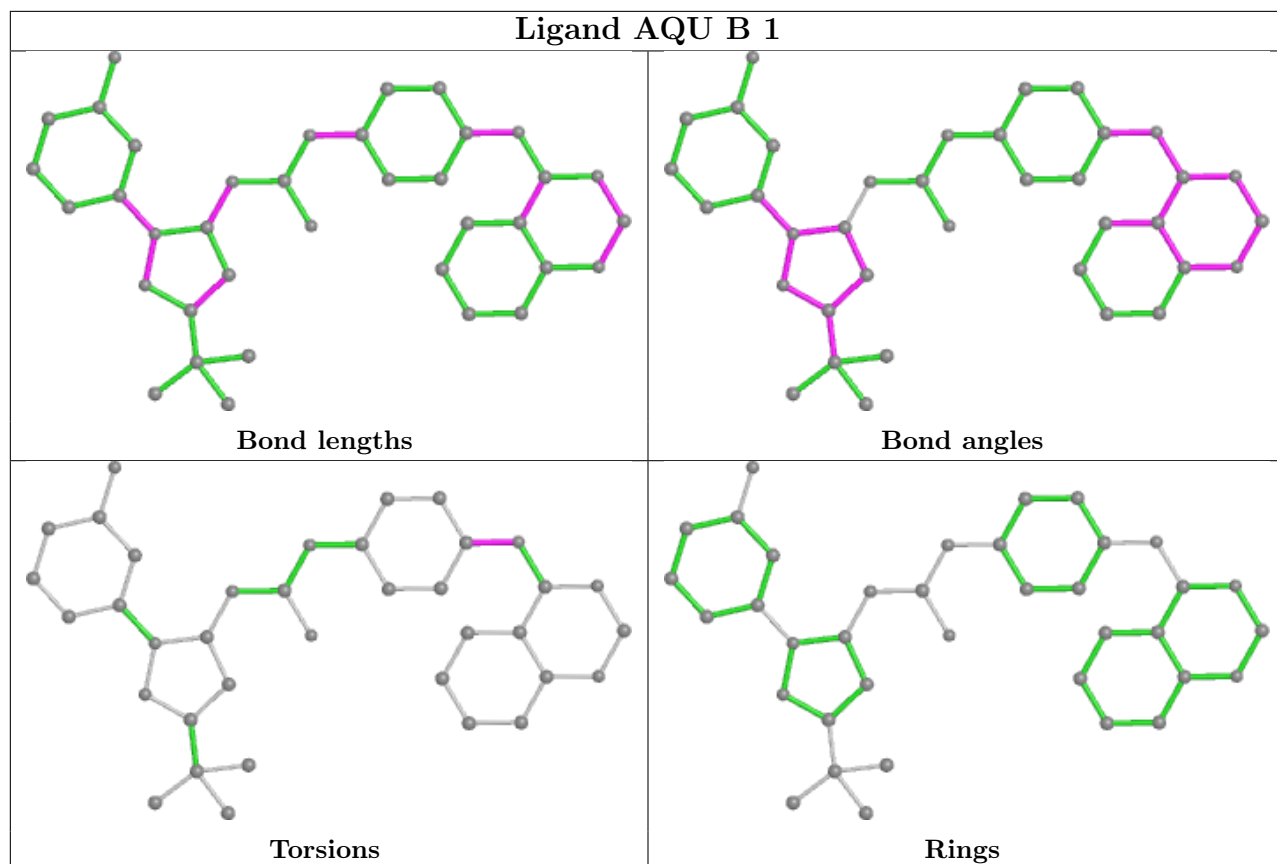

5.7 Other polymers [i](#)

There are no such residues in this entry.

5.8 Polymer linkage issues [i](#)

There are no chain breaks in this entry.

6 Fit of model and data [i](#)

6.1 Protein, DNA and RNA chains [i](#)

In the following table, the column labelled ‘#RSRZ > 2’ contains the number (and percentage) of RSRZ outliers, followed by percent RSRZ outliers for the chain as percentile scores relative to all X-ray entries and entries of similar resolution. The OWAB column contains the minimum, median, 95th percentile and maximum values of the occupancy-weighted average B-factor per residue. The column labelled ‘Q < 0.9’ lists the number of (and percentage) of residues with an average occupancy less than 0.9.

Mol	Chain	Analysed	<RSRZ>	#RSRZ>2	OWAB(Å ²)	Q<0.9
1	A	261/286 (91%)	-0.26	2 (0%) 86 72	19, 45, 86, 94	0
1	B	259/286 (90%)	-0.12	8 (3%) 49 26	21, 46, 105, 109	0
All	All	520/572 (90%)	-0.19	10 (1%) 66 46	19, 45, 102, 109	0

All (10) RSRZ outliers are listed below:

Mol	Chain	Res	Type	RSRZ
1	A	277	CYS	3.8
1	B	299	PRO	3.5
1	B	279	GLY	2.9
1	B	331	GLU	2.6
1	B	301	THR	2.4
1	B	277	CYS	2.2
1	A	305	GLU	2.2
1	B	278	PHE	2.1
1	B	297	LEU	2.0
1	B	300	GLY	2.0

6.2 Non-standard residues in protein, DNA, RNA chains [i](#)

There are no non-standard protein/DNA/RNA residues in this entry.

6.3 Carbohydrates [i](#)

There are no monosaccharides in this entry.

6.4 Ligands [i](#)

In the following table, the Atoms column lists the number of modelled atoms in the group and the number defined in the chemical component dictionary. The B-factors column lists the minimum, median, 95th percentile and maximum values of B factors of atoms in the group. The column labelled 'Q< 0.9' lists the number of atoms with occupancy less than 0.9.

Mol	Type	Chain	Res	Atoms	RSCC	RSR	B-factors(Å ²)	Q<0.9
2	AQU	B	1	37/37	0.92	0.25	69,70,72,72	0
2	AQU	A	1	37/37	0.95	0.19	44,49,51,51	0

The following is a graphical depiction of the model fit to experimental electron density of all instances of the Ligand of Interest. In addition, ligands with molecular weight > 250 and outliers as shown on the geometry validation Tables will also be included. Each fit is shown from different orientation to approximate a three-dimensional view.

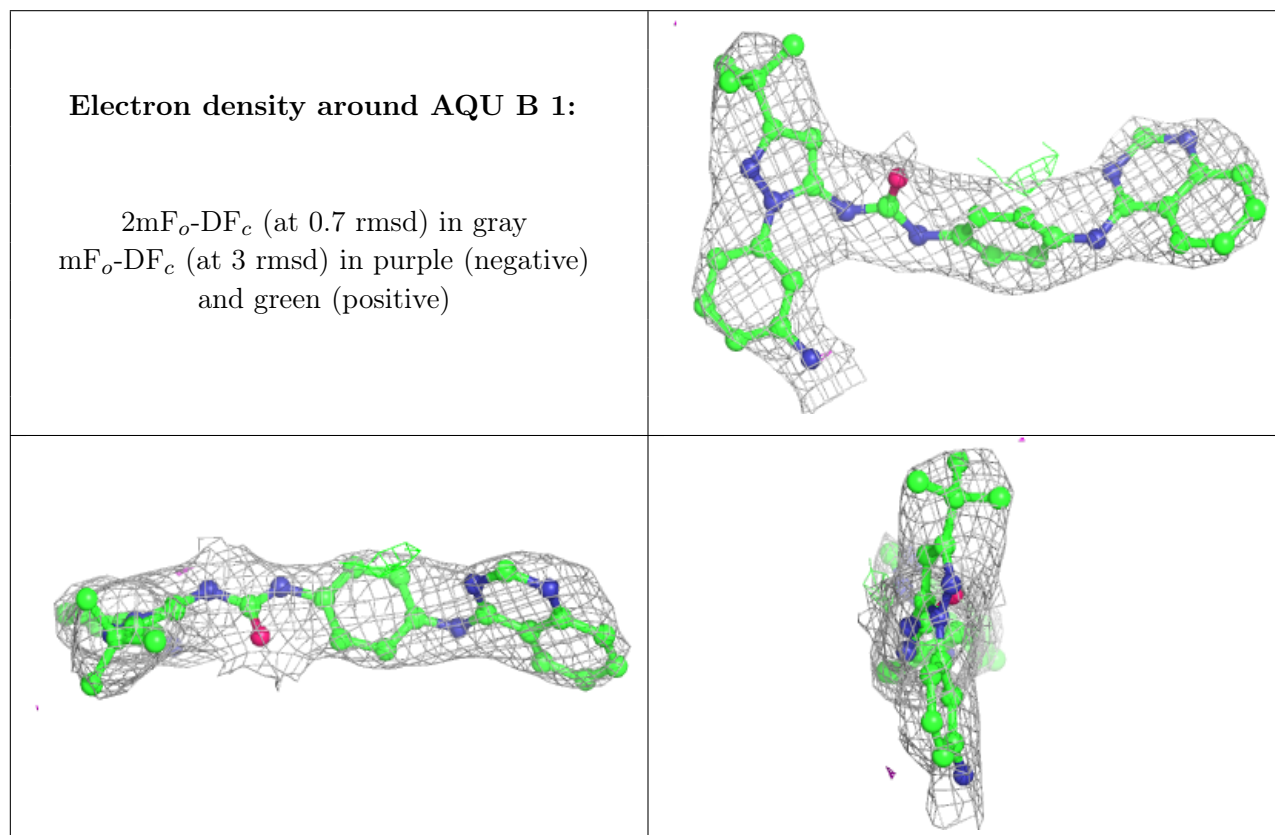

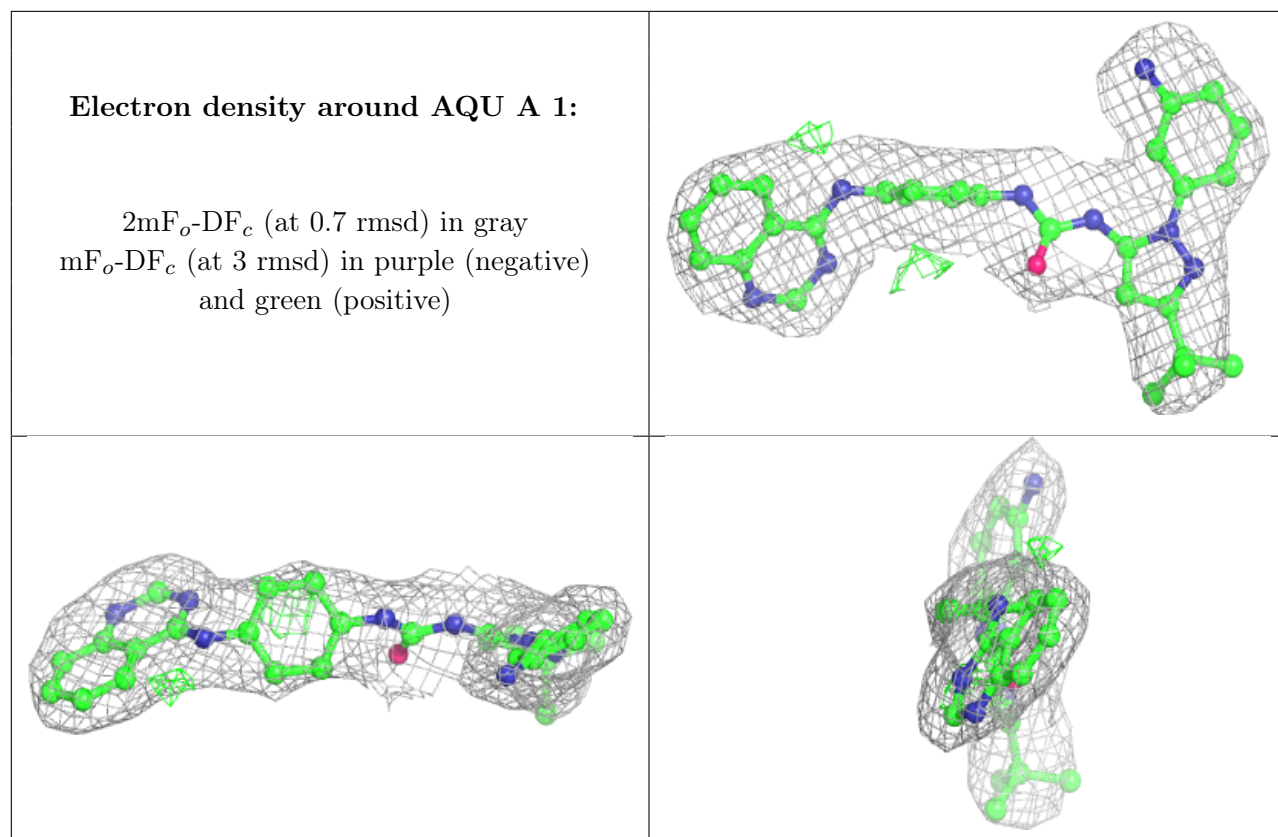

6.5 Other polymers [i](#)

There are no such residues in this entry.