



Full wwPDB X-ray Structure Validation Report ⓘ

Aug 28, 2023 – 10:57 PM EDT

PDB ID : 3N2B
Title : 1.8 Angstrom Resolution Crystal Structure of Diaminopimelate Decarboxylase (lysA) from *Vibrio cholerae*.
Authors : Minasov, G.; Halavaty, A.; Shuvalova, L.; Dubrovskaya, I.; Winsor, J.; Papazisi, L.; Anderson, W.F.; Center for Structural Genomics of Infectious Diseases (CSGID)
Deposited on : 2010-05-17
Resolution : 1.80 Å (reported)

This is a Full wwPDB X-ray Structure Validation Report for a publicly released PDB entry.

We welcome your comments at validation@mail.wwpdb.org

A user guide is available at

<https://www.wwpdb.org/validation/2017/XrayValidationReportHelp>

with specific help available everywhere you see the ⓘ symbol.

The types of validation reports are described at

<http://www.wwpdb.org/validation/2017/FAQs#types>.

The following versions of software and data (see [references ⓘ](#)) were used in the production of this report:

MolProbity : 4.02b-467
Xtriage (Phenix) : 1.13
EDS : 2.35
Percentile statistics : 20191225.v01 (using entries in the PDB archive December 25th 2019)
Refmac : 5.8.0158
CCP4 : 7.0.044 (Gargrove)
Ideal geometry (proteins) : Engh & Huber (2001)
Ideal geometry (DNA, RNA) : Parkinson et al. (1996)
Validation Pipeline (wwPDB-VP) : 2.35

1 Overall quality at a glance

The following experimental techniques were used to determine the structure:

X-RAY DIFFRACTION

The reported resolution of this entry is 1.80 Å.

Percentile scores (ranging between 0-100) for global validation metrics of the entry are shown in the following graphic. The table shows the number of entries on which the scores are based.

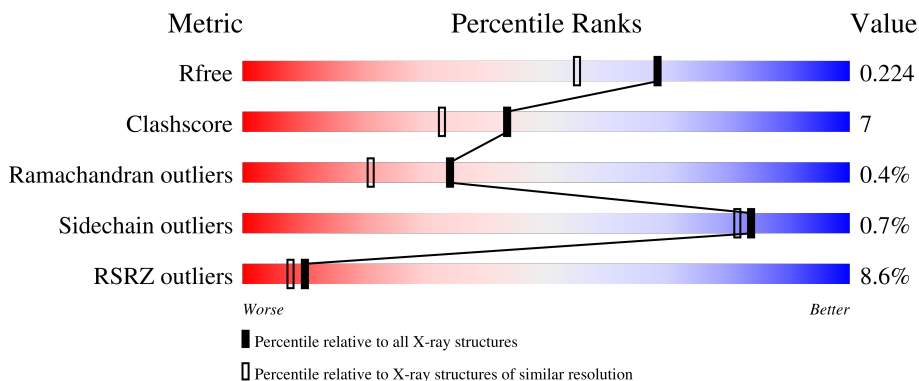

Metric	Whole archive (#Entries)	Similar resolution (#Entries, resolution range(Å))
R_{free}	130704	5950 (1.80-1.80)
Clashscore	141614	6793 (1.80-1.80)
Ramachandran outliers	138981	6697 (1.80-1.80)
Sidechain outliers	138945	6696 (1.80-1.80)
RSRZ outliers	127900	5850 (1.80-1.80)

The table below summarises the geometric issues observed across the polymeric chains and their fit to the electron density. The red, orange, yellow and green segments of the lower bar indicate the fraction of residues that contain outliers for ≥ 3 , 2, 1 and 0 types of geometric quality criteria respectively. A grey segment represents the fraction of residues that are not modelled. The numeric value for each fraction is indicated below the corresponding segment, with a dot representing fractions $\leq 5\%$. The upper red bar (where present) indicates the fraction of residues that have poor fit to the electron density. The numeric value is given above the bar.

Mol	Chain	Length	Quality of chain
1	A	441	 5% 84% 9% 7%
1	B	441	 8% 78% 10% 11%
1	C	441	 7% 83% 10% 7%
1	D	441	 11% 78% 12% 10%

2 Entry composition i

There are 3 unique types of molecules in this entry. The entry contains 14009 atoms, of which 0 are hydrogens and 0 are deuteriums.

In the tables below, the ZeroOcc column contains the number of atoms modelled with zero occupancy, the AltConf column contains the number of residues with at least one atom in alternate conformation and the Trace column contains the number of residues modelled with at most 2 atoms.

- Molecule 1 is a protein called Diaminopimelate decarboxylase.

Mol	Chain	Residues	Atoms					ZeroOcc	AltConf	Trace
			Total	C	N	O	S			
1	A	411	3279	2072	579	618	10	0	8	0
1	B	392	3123	1982	546	586	9	0	7	0
1	C	411	3283	2079	574	620	10	0	10	0
1	D	398	3179	2008	558	603	10	0	8	0

There are 96 discrepancies between the modelled and reference sequences:

Chain	Residue	Modelled	Actual	Comment	Reference
A	-23	MET	-	expression tag	UNP Q9KVL7
A	-22	HIS	-	expression tag	UNP Q9KVL7
A	-21	HIS	-	expression tag	UNP Q9KVL7
A	-20	HIS	-	expression tag	UNP Q9KVL7
A	-19	HIS	-	expression tag	UNP Q9KVL7
A	-18	HIS	-	expression tag	UNP Q9KVL7
A	-17	HIS	-	expression tag	UNP Q9KVL7
A	-16	SER	-	expression tag	UNP Q9KVL7
A	-15	SER	-	expression tag	UNP Q9KVL7
A	-14	GLY	-	expression tag	UNP Q9KVL7
A	-13	VAL	-	expression tag	UNP Q9KVL7
A	-12	ASP	-	expression tag	UNP Q9KVL7
A	-11	LEU	-	expression tag	UNP Q9KVL7
A	-10	GLY	-	expression tag	UNP Q9KVL7
A	-9	THR	-	expression tag	UNP Q9KVL7
A	-8	GLU	-	expression tag	UNP Q9KVL7
A	-7	ASN	-	expression tag	UNP Q9KVL7
A	-6	LEU	-	expression tag	UNP Q9KVL7
A	-5	TYR	-	expression tag	UNP Q9KVL7
A	-4	PHE	-	expression tag	UNP Q9KVL7
A	-3	GLN	-	expression tag	UNP Q9KVL7

Continued on next page...

Continued from previous page...

Chain	Residue	Modelled	Actual	Comment	Reference
A	-2	SER	-	expression tag	UNP Q9KVL7
A	-1	ASN	-	expression tag	UNP Q9KVL7
A	0	ALA	-	expression tag	UNP Q9KVL7
B	-23	MET	-	expression tag	UNP Q9KVL7
B	-22	HIS	-	expression tag	UNP Q9KVL7
B	-21	HIS	-	expression tag	UNP Q9KVL7
B	-20	HIS	-	expression tag	UNP Q9KVL7
B	-19	HIS	-	expression tag	UNP Q9KVL7
B	-18	HIS	-	expression tag	UNP Q9KVL7
B	-17	HIS	-	expression tag	UNP Q9KVL7
B	-16	SER	-	expression tag	UNP Q9KVL7
B	-15	SER	-	expression tag	UNP Q9KVL7
B	-14	GLY	-	expression tag	UNP Q9KVL7
B	-13	VAL	-	expression tag	UNP Q9KVL7
B	-12	ASP	-	expression tag	UNP Q9KVL7
B	-11	LEU	-	expression tag	UNP Q9KVL7
B	-10	GLY	-	expression tag	UNP Q9KVL7
B	-9	THR	-	expression tag	UNP Q9KVL7
B	-8	GLU	-	expression tag	UNP Q9KVL7
B	-7	ASN	-	expression tag	UNP Q9KVL7
B	-6	LEU	-	expression tag	UNP Q9KVL7
B	-5	TYR	-	expression tag	UNP Q9KVL7
B	-4	PHE	-	expression tag	UNP Q9KVL7
B	-3	GLN	-	expression tag	UNP Q9KVL7
B	-2	SER	-	expression tag	UNP Q9KVL7
B	-1	ASN	-	expression tag	UNP Q9KVL7
B	0	ALA	-	expression tag	UNP Q9KVL7
C	-23	MET	-	expression tag	UNP Q9KVL7
C	-22	HIS	-	expression tag	UNP Q9KVL7
C	-21	HIS	-	expression tag	UNP Q9KVL7
C	-20	HIS	-	expression tag	UNP Q9KVL7
C	-19	HIS	-	expression tag	UNP Q9KVL7
C	-18	HIS	-	expression tag	UNP Q9KVL7
C	-17	HIS	-	expression tag	UNP Q9KVL7
C	-16	SER	-	expression tag	UNP Q9KVL7
C	-15	SER	-	expression tag	UNP Q9KVL7
C	-14	GLY	-	expression tag	UNP Q9KVL7
C	-13	VAL	-	expression tag	UNP Q9KVL7
C	-12	ASP	-	expression tag	UNP Q9KVL7
C	-11	LEU	-	expression tag	UNP Q9KVL7
C	-10	GLY	-	expression tag	UNP Q9KVL7
C	-9	THR	-	expression tag	UNP Q9KVL7

Continued on next page...

Continued from previous page...

Chain	Residue	Modelled	Actual	Comment	Reference
C	-8	GLU	-	expression tag	UNP Q9KVL7
C	-7	ASN	-	expression tag	UNP Q9KVL7
C	-6	LEU	-	expression tag	UNP Q9KVL7
C	-5	TYR	-	expression tag	UNP Q9KVL7
C	-4	PHE	-	expression tag	UNP Q9KVL7
C	-3	GLN	-	expression tag	UNP Q9KVL7
C	-2	SER	-	expression tag	UNP Q9KVL7
C	-1	ASN	-	expression tag	UNP Q9KVL7
C	0	ALA	-	expression tag	UNP Q9KVL7
D	-23	MET	-	expression tag	UNP Q9KVL7
D	-22	HIS	-	expression tag	UNP Q9KVL7
D	-21	HIS	-	expression tag	UNP Q9KVL7
D	-20	HIS	-	expression tag	UNP Q9KVL7
D	-19	HIS	-	expression tag	UNP Q9KVL7
D	-18	HIS	-	expression tag	UNP Q9KVL7
D	-17	HIS	-	expression tag	UNP Q9KVL7
D	-16	SER	-	expression tag	UNP Q9KVL7
D	-15	SER	-	expression tag	UNP Q9KVL7
D	-14	GLY	-	expression tag	UNP Q9KVL7
D	-13	VAL	-	expression tag	UNP Q9KVL7
D	-12	ASP	-	expression tag	UNP Q9KVL7
D	-11	LEU	-	expression tag	UNP Q9KVL7
D	-10	GLY	-	expression tag	UNP Q9KVL7
D	-9	THR	-	expression tag	UNP Q9KVL7
D	-8	GLU	-	expression tag	UNP Q9KVL7
D	-7	ASN	-	expression tag	UNP Q9KVL7
D	-6	LEU	-	expression tag	UNP Q9KVL7
D	-5	TYR	-	expression tag	UNP Q9KVL7
D	-4	PHE	-	expression tag	UNP Q9KVL7
D	-3	GLN	-	expression tag	UNP Q9KVL7
D	-2	SER	-	expression tag	UNP Q9KVL7
D	-1	ASN	-	expression tag	UNP Q9KVL7
D	0	ALA	-	expression tag	UNP Q9KVL7

- Molecule 2 is CHLORIDE ION (three-letter code: CL) (formula: Cl).

Mol	Chain	Residues	Atoms	ZeroOcc	AltConf
2	A	1	Total Cl 1 1	0	0
2	C	2	Total Cl 2 2	0	0
2	D	1	Total Cl 1 1	0	0

- Molecule 3 is water.

Mol	Chain	Residues	Atoms		ZeroOcc	AltConf
3	A	324	Total 328	O 328	0	5
3	B	280	Total 284	O 284	0	4
3	C	285	Total 290	O 290	0	7
3	D	232	Total 239	O 239	0	7

3 Residue-property plots [i](#)

These plots are drawn for all protein, RNA, DNA and oligosaccharide chains in the entry. The first graphic for a chain summarises the proportions of the various outlier classes displayed in the second graphic. The second graphic shows the sequence view annotated by issues in geometry and electron density. Residues are color-coded according to the number of geometric quality criteria for which they contain at least one outlier: green = 0, yellow = 1, orange = 2 and red = 3 or more. A red dot above a residue indicates a poor fit to the electron density ($RSRZ > 2$). Stretches of 2 or more consecutive residues without any outlier are shown as a green connector. Residues present in the sample, but not in the model, are shown in grey.

- Molecule 1: Diaminopimelate decarboxylase

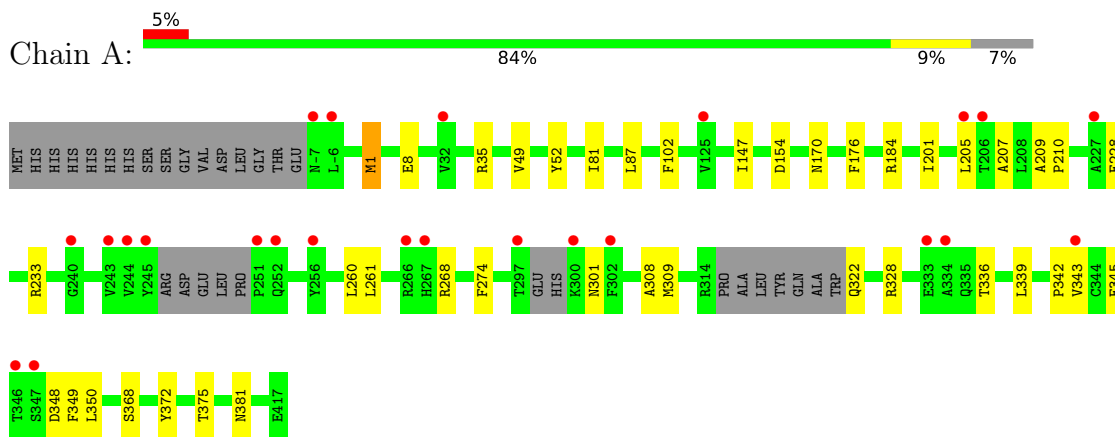

- Molecule 1: Diaminopimelate decarboxylase

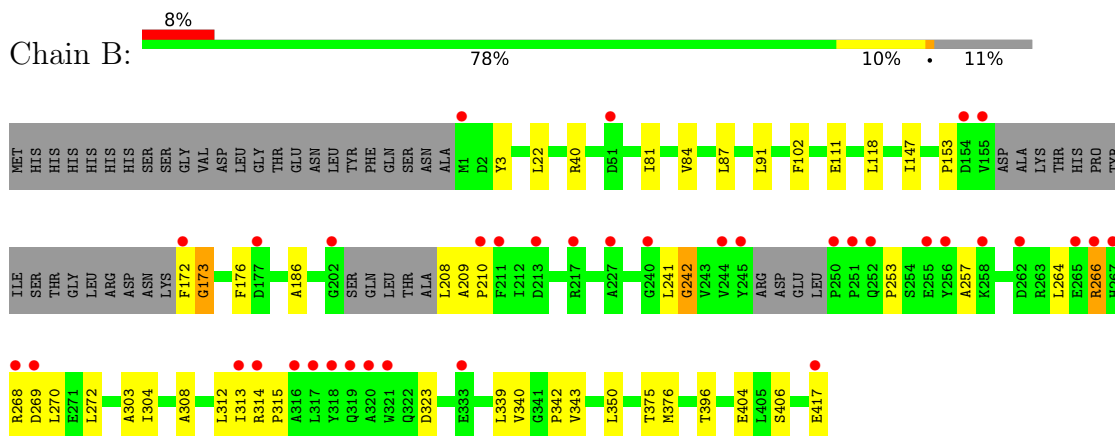

- Molecule 1: Diaminopimelate decarboxylase

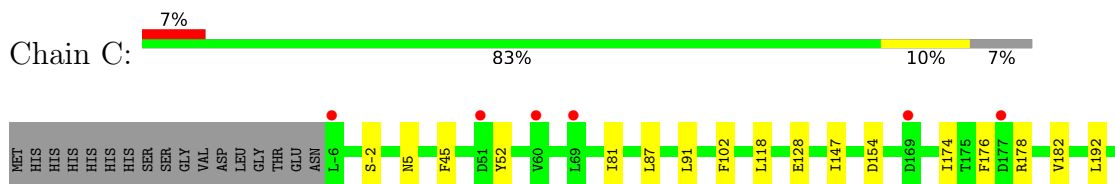

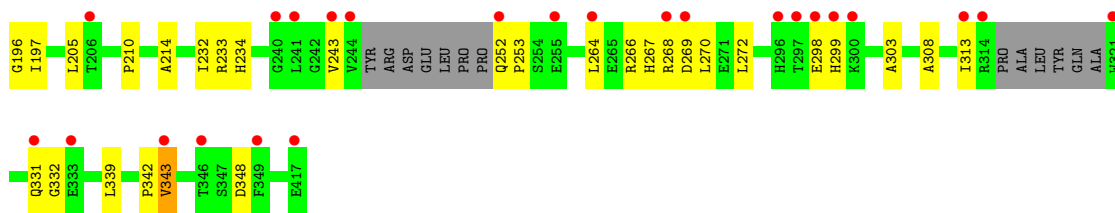

● Molecule 1: Diaminopimelate decarboxylase

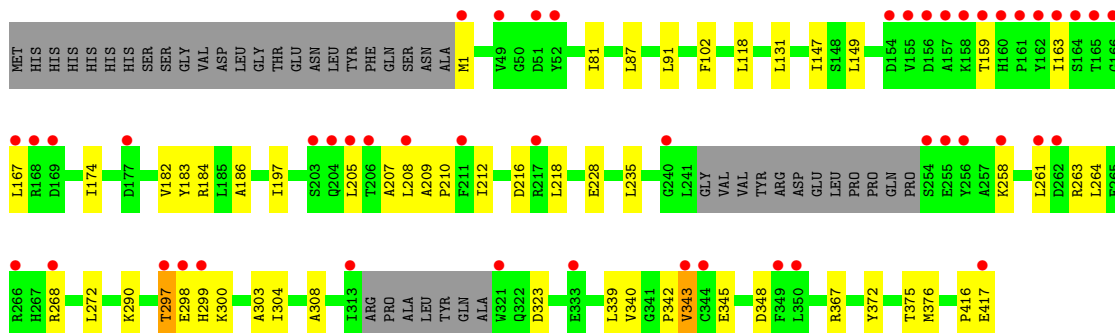
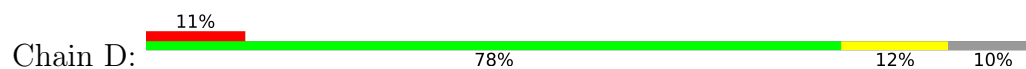

4 Data and refinement statistics

Property	Value	Source
Space group	P 1	Depositor
Cell constants a, b, c, α , β , γ	45.39Å 80.33Å 118.69Å 105.31° 93.62° 90.52°	Depositor
Resolution (Å)	29.94 – 1.80 29.83 – 1.80	Depositor EDS
% Data completeness (in resolution range)	97.5 (29.94-1.80) 97.5 (29.83-1.80)	Depositor EDS
R_{merge}	0.05	Depositor
R_{sym}	(Not available)	Depositor
$\langle I/\sigma(I) \rangle$ ¹	2.83 (at 1.80Å)	Xtrriage
Refinement program	REFMAC 5.5.0102	Depositor
R, R_{free}	0.183 , 0.219 0.188 , 0.224	Depositor DCC
R_{free} test set	7289 reflections (5.00%)	wwPDB-VP
Wilson B-factor (Å ²)	27.6	Xtrriage
Anisotropy	0.480	Xtrriage
Bulk solvent k_{sol} (e/Å ³), B_{sol} (Å ²)	0.35 , 51.9	EDS
L-test for twinning ²	$\langle L \rangle = 0.50$, $\langle L^2 \rangle = 0.33$	Xtrriage
Estimated twinning fraction	No twinning to report.	Xtrriage
F_o, F_c correlation	0.96	EDS
Total number of atoms	14009	wwPDB-VP
Average B, all atoms (Å ²)	40.0	wwPDB-VP

Xtrriage's analysis on translational NCS is as follows: *The largest off-origin peak in the Patterson function is 4.78% of the height of the origin peak. No significant pseudotranslation is detected.*

¹Intensities estimated from amplitudes.

²Theoretical values of $\langle |L| \rangle$, $\langle L^2 \rangle$ for acentric reflections are 0.5, 0.333 respectively for untwinned datasets, and 0.375, 0.2 for perfectly twinned datasets.

5 Model quality [i](#)

5.1 Standard geometry [i](#)

Bond lengths and bond angles in the following residue types are not validated in this section:
CL

The Z score for a bond length (or angle) is the number of standard deviations the observed value is removed from the expected value. A bond length (or angle) with $|Z| > 5$ is considered an outlier worth inspection. RMSZ is the root-mean-square of all Z scores of the bond lengths (or angles).

Mol	Chain	Bond lengths		Bond angles	
		RMSZ	# Z >5	RMSZ	# Z >5
1	A	0.58	0/3340	0.68	0/4521
1	B	0.56	0/3185	0.69	1/4317 (0.0%)
1	C	0.54	0/3352	0.68	0/4543
1	D	0.54	0/3239	0.68	0/4388
All	All	0.56	0/13116	0.68	1/17769 (0.0%)

There are no bond length outliers.

All (1) bond angle outliers are listed below:

Mol	Chain	Res	Type	Atoms	Z	Observed(°)	Ideal(°)
1	B	173	GLY	N-CA-C	5.05	125.72	113.10

There are no chirality outliers.

There are no planarity outliers.

5.2 Too-close contacts [i](#)

In the following table, the Non-H and H(model) columns list the number of non-hydrogen atoms and hydrogen atoms in the chain respectively. The H(added) column lists the number of hydrogen atoms added and optimized by MolProbity. The Clashes column lists the number of clashes within the asymmetric unit, whereas Symm-Clashes lists symmetry-related clashes.

Mol	Chain	Non-H	H(model)	H(added)	Clashes	Symm-Clashes
1	A	3279	0	3261	40	0
1	B	3123	0	3101	34	0
1	C	3283	0	3260	40	0
1	D	3179	0	3152	59	0
2	A	1	0	0	0	0
2	C	2	0	0	0	0

Continued on next page...

Continued from previous page...

Mol	Chain	Non-H	H(model)	H(added)	Clashes	Symm-Clashes
2	D	1	0	0	0	0
3	A	328	0	0	1	0
3	B	284	0	0	4	0
3	C	290	0	0	2	0
3	D	239	0	0	3	0
All	All	14009	0	12774	171	0

The all-atom clashscore is defined as the number of clashes found per 1000 atoms (including hydrogen atoms). The all-atom clashscore for this structure is 7.

All (171) close contacts within the same asymmetric unit are listed below, sorted by their clash magnitude.

Atom-1	Atom-2	Interatomic distance (Å)	Clash overlap (Å)
1:A:233[B]:ARG:NH2	1:A:233[B]:ARG:HG2	1.58	1.05
1:A:233[B]:ARG:HH21	1:A:233[B]:ARG:CG	1.74	0.99
1:A:233[B]:ARG:HG2	1:A:233[B]:ARG:HH21	0.84	0.98
1:A:343:VAL:HG13	1:A:381:ASN:OD1	1.64	0.97
1:A:308:ALA:HB1	1:A:343:VAL:HG23	1.50	0.93
1:C:264:LEU:HD13	1:C:272:LEU:HD11	1.50	0.92
1:B:304:ILE:HD13	1:B:340:VAL:CG2	2.02	0.90
1:A:343:VAL:HG12	1:A:345:GLU:HG2	1.58	0.85
1:C:91[B]:LEU:HD11	1:C:118:LEU:CD1	2.09	0.82
1:D:268[B]:ARG:NE	1:D:268[B]:ARG:H	1.80	0.80
1:A:308:ALA:HB1	1:A:343:VAL:CG2	2.13	0.79
1:D:268[B]:ARG:H	1:D:268[B]:ARG:HE	1.31	0.79
1:D:298:GLU:HB2	1:D:299:HIS:HA	1.65	0.77
1:B:304:ILE:HD13	1:B:340:VAL:HG23	1.66	0.76
1:B:91[A]:LEU:HD11	1:B:118:LEU:HD13	1.67	0.76
1:C:264:LEU:CD1	1:C:272:LEU:HD11	2.14	0.76
1:A:308:ALA:HB2	1:A:342:PRO:HD2	1.67	0.75
1:C:91[B]:LEU:HD11	1:C:118:LEU:HD13	1.68	0.75
1:D:304:ILE:HD13	1:D:340:VAL:CG2	2.17	0.75
1:C:264:LEU:HD13	1:C:272:LEU:HD21	1.67	0.75
1:D:218:LEU:HD21	1:D:235:LEU:HD11	1.69	0.74
1:A:8[B]:GLU:O	1:A:8[B]:GLU:CD	2.27	0.73
1:B:147:ILE:HD11	1:B:186:ALA:HB1	1.72	0.71
1:D:343:VAL:HG22	1:D:348:ASP:OD2	1.91	0.71
1:D:304:ILE:HD13	1:D:340:VAL:HG23	1.74	0.69
1:D:297:THR:HB	1:D:298:GLU:HA	1.73	0.69
1:B:268:ARG:CB	1:B:269:ASP:HA	2.23	0.69
1:B:396:THR:HG23	3:B:520:HOH:O	1.91	0.69

Continued on next page...

Continued from previous page...

Atom-1	Atom-2	Interatomic distance (Å)	Clash overlap (Å)
1:D:297:THR:HG22	1:D:298:GLU:O	1.91	0.69
1:C:331[B]:GLN:OE1	1:C:332:GLY:N	2.26	0.68
1:A:8[B]:GLU:OE2	1:A:8[B]:GLU:C	2.34	0.66
1:B:268:ARG:HB3	1:B:269:ASP:HA	1.79	0.64
1:D:208:LEU:HD21	1:D:212:ILE:HD11	1.80	0.64
1:D:147:ILE:HD11	1:D:186:ALA:HB1	1.78	0.64
1:C:264:LEU:CD1	1:C:272:LEU:HD21	2.27	0.64
1:D:174:ILE:HD13	1:D:182:VAL:HG21	1.79	0.64
1:C:91[B]:LEU:HD11	1:C:118:LEU:HD11	1.81	0.62
1:A:268:ARG:HG2	1:A:268:ARG:O	1.99	0.62
1:B:91[A]:LEU:HD11	1:B:118:LEU:CD1	2.29	0.61
1:B:304:ILE:CD1	1:B:340:VAL:HG23	2.31	0.61
1:D:91:LEU:HD11	1:D:118:LEU:CD1	2.31	0.61
1:D:208:LEU:HD23	1:D:208:LEU:O	2.01	0.60
1:D:290:LYS:HE3	3:D:524:HOH:O	2.01	0.60
1:C:264:LEU:HD13	1:C:272:LEU:CD1	2.26	0.60
1:B:304:ILE:CD1	1:B:340:VAL:CG2	2.77	0.60
1:C:308:ALA:HB2	1:C:342:PRO:HD2	1.84	0.59
1:A:1:MET:HA	1:A:1:MET:HE2	1.84	0.59
1:B:264:LEU:CD1	1:B:272:LEU:HD21	2.33	0.58
1:D:81:ILE:HD13	1:D:87:LEU:HB2	1.85	0.58
1:D:261:LEU:HD23	1:D:261:LEU:O	2.03	0.58
1:B:3:TYR:OH	1:B:40[A]:ARG:NH1	2.36	0.58
1:A:233[B]:ARG:NH2	1:A:233[B]:ARG:CG	2.43	0.58
1:C:174:ILE:CD1	1:C:182:VAL:HG11	2.34	0.58
1:C:268:ARG:HB3	1:C:269:ASP:HA	1.86	0.57
1:A:35:ARG:NH2	1:B:417:GLU:OE1	2.37	0.57
1:B:253:PRO:HB2	1:B:257:ALA:HB3	1.85	0.57
1:A:308:ALA:CB	1:A:343:VAL:HG23	2.30	0.57
1:C:147[A]:ILE:HD13	1:C:192:LEU:HD13	1.86	0.57
1:B:314:ARG:HB2	1:B:315:PRO:HD3	1.88	0.56
1:A:349:PHE:C	1:A:350:LEU:HD12	2.26	0.56
1:C:128:GLU:OE2	1:C:178:ARG:NH2	2.33	0.55
1:C:52:TYR:CE2	1:C:272:LEU:HG	2.40	0.55
1:A:8[B]:GLU:CD	1:A:8[B]:GLU:C	2.64	0.55
1:D:297:THR:HB	1:D:298:GLU:CA	2.35	0.55
1:C:303:ALA:HB3	1:C:339:LEU:HD13	1.88	0.55
1:A:201:ILE:HD11	1:A:260:LEU:HD22	1.89	0.55
1:D:303:ALA:HB3	1:D:339:LEU:HD13	1.89	0.54
1:C:174:ILE:HD13	1:C:182:VAL:HG11	1.90	0.54
1:C:343:VAL:HG22	1:C:348:ASP:OD2	2.07	0.53

Continued on next page...

Continued from previous page...

Atom-1	Atom-2	Interatomic distance (Å)	Clash overlap (Å)
1:A:343:VAL:N	1:A:348:ASP:OD2	2.42	0.53
1:D:304:ILE:CD1	1:D:340:VAL:HG23	2.38	0.53
1:C:196:GLY:HA2	1:C:232:ILE:HG23	1.92	0.52
1:D:159:THR:HG22	3:D:465:HOH:O	2.08	0.52
1:C:264:LEU:HD13	1:C:272:LEU:CD2	2.37	0.52
1:B:208:LEU:O	1:B:208:LEU:HD23	2.10	0.52
1:D:308:ALA:HB2	1:D:342:PRO:HD2	1.92	0.52
1:C:268:ARG:HA	1:C:270:LEU:H	1.75	0.52
1:D:339:LEU:HD22	1:D:339:LEU:N	2.25	0.52
1:D:91:LEU:HD11	1:D:118:LEU:HD11	1.93	0.51
1:D:163:ILE:O	1:D:167:LEU:HD13	2.10	0.51
1:D:208:LEU:HD21	1:D:212:ILE:CD1	2.39	0.51
1:A:81:ILE:HD13	1:A:87:LEU:HB2	1.92	0.51
1:C:266:ARG:HG3	1:C:267:HIS:N	2.26	0.51
1:A:309:MET:HG2	1:A:343:VAL:HG21	1.93	0.50
1:B:241:LEU:HB3	1:B:242:GLY:HA3	1.93	0.50
1:D:184:ARG:NE	1:D:228:GLU:OE2	2.38	0.50
1:B:264:LEU:HD11	1:B:272:LEU:HD21	1.92	0.50
1:B:81:ILE:HD13	1:B:87:LEU:HB2	1.94	0.50
1:B:308:ALA:HB2	1:B:342:PRO:HD2	1.94	0.50
1:D:264:LEU:HD11	1:D:272:LEU:HD21	1.94	0.50
1:C:45:PHE:HA	1:C:243:VAL:HG21	1.94	0.49
1:A:81:ILE:CD1	1:A:87:LEU:HB2	2.42	0.49
1:D:131:LEU:HD11	1:D:147:ILE:HD13	1.95	0.49
1:D:208:LEU:HD23	1:D:208:LEU:C	2.32	0.49
1:A:49[B]:VAL:HG11	1:A:274:PHE:CE2	2.49	0.48
1:A:49[A]:VAL:HG13	1:A:261:LEU:HD21	1.96	0.48
1:D:216:ASP:OD1	1:D:263:ARG:HD3	2.13	0.48
1:A:147:ILE:C	1:A:147:ILE:HD12	2.34	0.48
1:D:212:ILE:HG23	1:D:263:ARG:HD2	1.94	0.48
1:B:303:ALA:HB3	1:B:339:LEU:HD13	1.95	0.48
1:D:209:ALA:HB3	1:D:210:PRO:HD3	1.94	0.48
1:B:264:LEU:HD12	1:B:272:LEU:HD11	1.96	0.47
1:D:209:ALA:HB3	1:D:210:PRO:CD	2.44	0.47
1:D:375:THR:HG23	1:D:376:MET:HG3	1.96	0.47
1:D:298:GLU:HB2	1:D:299:HIS:CA	2.41	0.47
1:B:209:ALA:N	1:B:210:PRO:HD2	2.29	0.47
1:C:154:ASP:HB2	1:C:176:PHE:CG	2.50	0.47
1:D:197:ILE:HG23	1:D:235:LEU:CD1	2.44	0.47
1:D:208:LEU:CD2	1:D:212:ILE:CD1	2.92	0.47
1:B:84:VAL:HB	1:B:111:GLU:HG2	1.96	0.47

Continued on next page...

Continued from previous page...

Atom-1	Atom-2	Interatomic distance (Å)	Clash overlap (Å)
1:D:149:LEU:HD12	1:D:183:TYR:CD1	2.49	0.47
1:B:342:PRO:O	3:B:957:HOH:O	2.20	0.47
1:C:-2:SER:HA	1:C:5:ASN:ND2	2.29	0.47
1:A:1:MET:HA	1:A:1:MET:CE	2.44	0.47
1:A:350:LEU:HD12	1:A:350:LEU:N	2.30	0.46
1:A:339:LEU:HD12	1:A:339:LEU:N	2.30	0.46
1:D:264:LEU:CD1	1:D:272:LEU:HD21	2.45	0.46
1:B:268:ARG:HA	1:B:270:LEU:H	1.80	0.46
1:A:154:ASP:HB2	1:A:176:PHE:CG	2.51	0.45
1:A:328:ARG:CZ	1:C:331[B]:GLN:HG2	2.46	0.45
1:C:197:ILE:HB	1:C:232:ILE:HD13	1.98	0.45
1:A:209:ALA:HB3	1:A:210:PRO:CD	2.46	0.45
1:D:218:LEU:HD21	1:D:235:LEU:CD1	2.43	0.45
1:B:404[A]:GLU:OE2	1:B:406[A]:SER:OG	2.30	0.45
1:C:81:ILE:CD1	1:C:87:LEU:HB2	2.47	0.45
1:C:52:TYR:OH	1:C:267:HIS:O	2.29	0.44
1:C:234:HIS:CE1	3:C:441:HOH:O	2.69	0.44
1:D:304:ILE:CD1	1:D:340:VAL:CG2	2.90	0.44
1:A:301:ASN:HB2	1:A:336:THR:O	2.17	0.44
1:A:184:ARG:NE	1:A:228:GLU:OE1	2.34	0.44
1:D:205:LEU:HD12	1:D:205:LEU:N	2.32	0.44
1:D:372:TYR:HA	1:D:375:THR:CG2	2.47	0.44
1:D:91:LEU:HD11	1:D:118:LEU:HD13	1.98	0.44
1:D:323:ASP:HB3	1:D:367:ARG:HD3	1.98	0.44
1:B:323:ASP:OD1	3:B:951:HOH:O	2.21	0.43
1:A:343:VAL:CG1	1:A:345:GLU:HG2	2.38	0.43
1:A:268:ARG:O	1:A:268:ARG:CG	2.66	0.43
1:B:22:LEU:HD21	1:B:396:THR:HG21	2.00	0.43
1:B:266:ARG:H	1:B:266:ARG:CD	2.32	0.43
1:D:290:LYS:CE	3:D:524:HOH:O	2.65	0.43
1:B:312:LEU:HD23	1:B:350:LEU:HD22	2.01	0.43
1:C:313:ILE:O	1:C:313:ILE:HG23	2.19	0.42
1:D:343:VAL:CG2	1:D:348:ASP:OD2	2.63	0.42
1:D:197:ILE:HG23	1:D:235:LEU:HD12	2.01	0.42
1:C:268:ARG:HA	1:C:270:LEU:N	2.33	0.42
1:C:339:LEU:N	1:C:339:LEU:HD22	2.35	0.42
1:B:313:ILE:HG22	3:B:949:HOH:O	2.20	0.42
1:C:205:LEU:HD22	1:C:210:PRO:HB2	2.01	0.42
1:C:233:ARG:O	1:C:270:LEU:HA	2.20	0.42
1:B:153:PRO:HA	1:B:176:PHE:HE1	1.85	0.41
1:D:345:GLU:HB2	1:D:348:ASP:HB2	2.01	0.41

Continued on next page...

Continued from previous page...

Atom-1	Atom-2	Interatomic distance (Å)	Clash overlap (Å)
1:D:416:PRO:O	1:D:417:GLU:HB2	2.20	0.41
3:C:515:HOH:O	1:D:297:THR:HG22	2.19	0.41
1:A:207:ALA:HB1	3:A:576[B]:HOH:O	2.20	0.41
1:C:252:GLN:HB2	1:C:253:PRO:HD3	2.03	0.41
1:A:322:GLN:HG2	1:A:368[B]:SER:OG	2.21	0.41
1:A:372:TYR:HA	1:A:375:THR:CG2	2.50	0.41
1:D:174:ILE:HD11	1:D:182:VAL:HG11	2.02	0.41
1:D:207:ALA:HB3	1:D:210:PRO:CG	2.51	0.41
1:D:268[A]:ARG:HA	1:D:268[A]:ARG:HD3	1.80	0.41
1:D:297:THR:HB	1:D:300:LYS:H	1.86	0.41
1:A:49[A]:VAL:HG12	1:A:52:TYR:HB3	2.02	0.40
1:A:209:ALA:HB3	1:A:210:PRO:HD3	2.01	0.40
1:D:131:LEU:HD11	1:D:147:ILE:CD1	2.51	0.40
1:C:298:GLU:HA	1:C:299:HIS:HA	1.85	0.40
1:D:264:LEU:CD1	1:D:272:LEU:HD11	2.52	0.40
1:D:372:TYR:HA	1:D:375:THR:HG22	2.03	0.40
1:B:375:THR:HG23	1:B:376:MET:HG3	2.03	0.40
1:C:205:LEU:HD11	1:C:214:ALA:CB	2.52	0.40

There are no symmetry-related clashes.

5.3 Torsion angles [i](#)

5.3.1 Protein backbone [i](#)

In the following table, the Percentiles column shows the percent Ramachandran outliers of the chain as a percentile score with respect to all X-ray entries followed by that with respect to entries of similar resolution.

The Analysed column shows the number of residues for which the backbone conformation was analysed, and the total number of residues.

Mol	Chain	Analysed	Favoured	Allowed	Outliers	Percentiles	
1	A	411/441 (93%)	404 (98%)	6 (2%)	1 (0%)	47	33
1	B	391/441 (89%)	374 (96%)	14 (4%)	3 (1%)	19	7
1	C	415/441 (94%)	404 (97%)	10 (2%)	1 (0%)	47	33
1	D	400/441 (91%)	384 (96%)	14 (4%)	2 (0%)	29	15
All	All	1617/1764 (92%)	1566 (97%)	44 (3%)	7 (0%)	34	21

All (7) Ramachandran outliers are listed below:

Mol	Chain	Res	Type
1	B	343	VAL
1	C	343	VAL
1	D	343	VAL
1	A	205	LEU
1	D	297	THR
1	B	242	GLY
1	B	173	GLY

5.3.2 Protein sidechains [i](#)

In the following table, the Percentiles column shows the percent sidechain outliers of the chain as a percentile score with respect to all X-ray entries followed by that with respect to entries of similar resolution.

The Analysed column shows the number of residues for which the sidechain conformation was analysed, and the total number of residues.

Mol	Chain	Analysed	Rotameric	Outliers	Percentiles	
1	A	350/368 (95%)	347 (99%)	3 (1%)	78	75
1	B	332/368 (90%)	329 (99%)	3 (1%)	78	75
1	C	351/368 (95%)	350 (100%)	1 (0%)	92	91
1	D	339/368 (92%)	336 (99%)	3 (1%)	78	75
All	All	1372/1472 (93%)	1362 (99%)	10 (1%)	84	81

All (10) residues with a non-rotameric sidechain are listed below:

Mol	Chain	Res	Type
1	A	1	MET
1	A	102	PHE
1	A	170	ASN
1	B	102	PHE
1	B	172	PHE
1	B	266	ARG
1	C	102	PHE
1	D	1	MET
1	D	102	PHE
1	D	258	LYS

Sometimes sidechains can be flipped to improve hydrogen bonding and reduce clashes. All (4) such sidechains are listed below:

Mol	Chain	Res	Type
1	A	170	ASN
1	A	283	ASN
1	B	25	GLN
1	B	319	GLN

5.3.3 RNA [i](#)

There are no RNA molecules in this entry.

5.4 Non-standard residues in protein, DNA, RNA chains [i](#)

There are no non-standard protein/DNA/RNA residues in this entry.

5.5 Carbohydrates [i](#)

There are no monosaccharides in this entry.

5.6 Ligand geometry [i](#)

Of 4 ligands modelled in this entry, 4 are monoatomic - leaving 0 for Mogul analysis.

There are no bond length outliers.

There are no bond angle outliers.

There are no chirality outliers.

There are no torsion outliers.

There are no ring outliers.

No monomer is involved in short contacts.

5.7 Other polymers [i](#)

There are no such residues in this entry.

5.8 Polymer linkage issues [i](#)

There are no chain breaks in this entry.

6 Fit of model and data [i](#)

6.1 Protein, DNA and RNA chains [i](#)

In the following table, the column labelled ‘#RSRZ > 2’ contains the number (and percentage) of RSRZ outliers, followed by percent RSRZ outliers for the chain as percentile scores relative to all X-ray entries and entries of similar resolution. The OWAB column contains the minimum, median, 95th percentile and maximum values of the occupancy-weighted average B-factor per residue. The column labelled ‘Q < 0.9’ lists the number of (and percentage) of residues with an average occupancy less than 0.9.

Mol	Chain	Analysed	<RSRZ>	#RSRZ>2	OWAB(Å ²)	Q<0.9
1	A	411/441 (93%)	0.28	24 (5%) 23 18	24, 34, 60, 76	0
1	B	392/441 (88%)	0.37	37 (9%) 8 6	23, 35, 78, 89	0
1	C	411/441 (93%)	0.21	30 (7%) 15 11	25, 37, 58, 70	0
1	D	398/441 (90%)	0.35	48 (12%) 4 3	24, 37, 68, 86	0
All	All	1612/1764 (91%)	0.30	139 (8%) 10 8	23, 36, 66, 89	0

All (139) RSRZ outliers are listed below:

Mol	Chain	Res	Type	RSRZ
1	B	245	TYR	10.1
1	B	155	VAL	9.6
1	B	244	VAL	9.3
1	B	318	TYR	8.9
1	C	298	GLU	8.3
1	A	251	PRO	7.9
1	D	157	ALA	7.8
1	B	1	MET	7.5
1	D	321	TRP	7.3
1	A	205	LEU	7.2
1	D	156	ASP	6.9
1	B	317	LEU	6.9
1	D	155	VAL	6.6
1	A	245	TYR	6.4
1	A	-6	LEU	6.3
1	B	319	GLN	6.2
1	D	1	MET	6.0
1	A	346	THR	5.9
1	C	269	ASP	5.9
1	C	321	TRP	5.8
1	C	243	VAL	5.8

Continued on next page...

Continued from previous page...

Mol	Chain	Res	Type	RSRZ
1	B	269	ASP	5.7
1	C	346	THR	5.6
1	D	349	PHE	5.5
1	B	154	ASP	5.5
1	D	163	ILE	5.3
1	B	265	GLU	5.2
1	B	320	ALA	5.1
1	B	316	ALA	5.0
1	C	244	VAL	5.0
1	A	244	VAL	4.9
1	C	-6	LEU	4.8
1	C	299	HIS	4.7
1	B	211	PHE	4.6
1	B	251	PRO	4.6
1	A	267	HIS	4.5
1	B	255	GLU	4.5
1	D	206	THR	4.5
1	D	158	LYS	4.4
1	D	203	SER	4.3
1	D	159	THR	4.3
1	D	240	GLY	4.3
1	B	417	GLU	4.3
1	B	227	ALA	4.2
1	D	162	TYR	4.1
1	D	167	LEU	4.0
1	A	243	VAL	4.0
1	D	343	VAL	4.0
1	B	210	PRO	3.9
1	D	164	SER	3.9
1	D	165	THR	3.8
1	C	313	ILE	3.8
1	D	261	LEU	3.8
1	D	51	ASP	3.7
1	D	161	PRO	3.7
1	A	-7	ASN	3.7
1	A	333	GLU	3.7
1	D	255	GLU	3.6
1	A	300	LYS	3.6
1	B	250	PRO	3.6
1	D	333	GLU	3.6
1	A	334	ALA	3.6
1	B	256	TYR	3.6

Continued on next page...

Continued from previous page...

Mol	Chain	Res	Type	RSRZ
1	B	267	HIS	3.5
1	A	266	ARG	3.5
1	B	202	GLY	3.5
1	C	252	GLN	3.5
1	C	333	GLU	3.4
1	A	297	THR	3.4
1	D	205	LEU	3.3
1	C	51[A]	ASP	3.3
1	C	268	ARG	3.2
1	D	52	TYR	3.1
1	A	343	VAL	3.1
1	D	169	ASP	3.1
1	D	254	SER	3.1
1	D	297	THR	3.0
1	B	268	ARG	3.0
1	D	417	GLU	3.0
1	C	349	PHE	3.0
1	A	252	GLN	3.0
1	C	206	THR	2.9
1	D	160	HIS	2.9
1	C	300	LYS	2.9
1	A	256	TYR	2.9
1	D	268[A]	ARG	2.9
1	D	256	TYR	2.8
1	C	241	LEU	2.7
1	B	177	ASP	2.7
1	D	313	ILE	2.7
1	B	172	PHE	2.7
1	D	204	GLN	2.7
1	B	266	ARG	2.7
1	C	314	ARG	2.7
1	C	331[A]	GLN	2.7
1	D	168	ARG	2.7
1	C	255	GLU	2.7
1	D	299	HIS	2.6
1	A	206	THR	2.6
1	D	154	ASP	2.6
1	D	258	LYS	2.5
1	B	321	TRP	2.5
1	B	333	GLU	2.5
1	B	51	ASP	2.5
1	B	313	ILE	2.5

Continued on next page...

Continued from previous page...

Mol	Chain	Res	Type	RSRZ
1	D	298	GLU	2.5
1	D	344	CYS	2.5
1	D	177	ASP	2.5
1	A	347	SER	2.5
1	C	60	VAL	2.4
1	B	240	GLY	2.4
1	A	240	GLY	2.4
1	D	217	ARG	2.4
1	A	227	ALA	2.4
1	C	177	ASP	2.4
1	C	264	LEU	2.4
1	C	297	THR	2.4
1	C	240	GLY	2.4
1	B	314	ARG	2.3
1	A	32	VAL	2.3
1	D	166	GLY	2.3
1	C	343	VAL	2.3
1	A	302	PHE	2.2
1	D	262	ASP	2.2
1	D	350	LEU	2.2
1	B	262	ASP	2.2
1	D	49	VAL	2.2
1	D	266	ARG	2.2
1	B	213	ASP	2.2
1	D	211	PHE	2.2
1	C	169	ASP	2.2
1	C	296	HIS	2.1
1	A	125	VAL	2.1
1	C	417	GLU	2.1
1	B	258	LYS	2.1
1	B	252	GLN	2.1
1	B	217	ARG	2.0
1	D	208	LEU	2.0
1	C	69	LEU	2.0

6.2 Non-standard residues in protein, DNA, RNA chains [\(i\)](#)

There are no non-standard protein/DNA/RNA residues in this entry.

6.3 Carbohydrates [i](#)

There are no monosaccharides in this entry.

6.4 Ligands [i](#)

In the following table, the Atoms column lists the number of modelled atoms in the group and the number defined in the chemical component dictionary. The B-factors column lists the minimum, median, 95th percentile and maximum values of B factors of atoms in the group. The column labelled 'Q< 0.9' lists the number of atoms with occupancy less than 0.9.

Mol	Type	Chain	Res	Atoms	RSCC	RSR	B-factors(Å ²)	Q<0.9
2	CL	C	419	1/1	0.97	0.04	43,43,43,43	0
2	CL	C	418	1/1	0.99	0.04	38,38,38,38	0
2	CL	A	418	1/1	0.99	0.04	44,44,44,44	0
2	CL	D	418	1/1	1.00	0.03	42,42,42,42	0

6.5 Other polymers [i](#)

There are no such residues in this entry.