



# Full wwPDB X-ray Structure Validation Report ⓘ

Oct 28, 2024 – 06:14 PM EDT

PDB ID : 3D4I  
Title : Crystal structure of the 2H-phosphatase domain of Sts-2  
Authors : Chen, Y.; Carpino, N.; Nassar, N.  
Deposited on : 2008-05-14  
Resolution : 1.95 Å(reported)

This is a Full wwPDB X-ray Structure Validation Report for a publicly released PDB entry.

We welcome your comments at [validation@mail.wwpdb.org](mailto:validation@mail.wwpdb.org)

A user guide is available at

<https://www.wwpdb.org/validation/2017/XrayValidationReportHelp>

with specific help available everywhere you see the ⓘ symbol.

The types of validation reports are described at

<http://www.wwpdb.org/validation/2017/FAQs#types>.

---

The following versions of software and data (see [references ⓘ](#)) were used in the production of this report:

MolProbity : 4.02b-467  
Xtriage (Phenix) : 1.20.1  
EDS : 3.0  
Percentile statistics : 20231227.v01 (using entries in the PDB archive December 27th 2023)  
CCP4 : 9.0.003 (Gargrove)  
Density-Fitness : 1.0.11  
Ideal geometry (proteins) : Engh & Huber (2001)  
Ideal geometry (DNA, RNA) : Parkinson et al. (1996)  
Validation Pipeline (wwPDB-VP) : 2.39

# 1 Overall quality at a glance

The following experimental techniques were used to determine the structure:

*X-RAY DIFFRACTION*



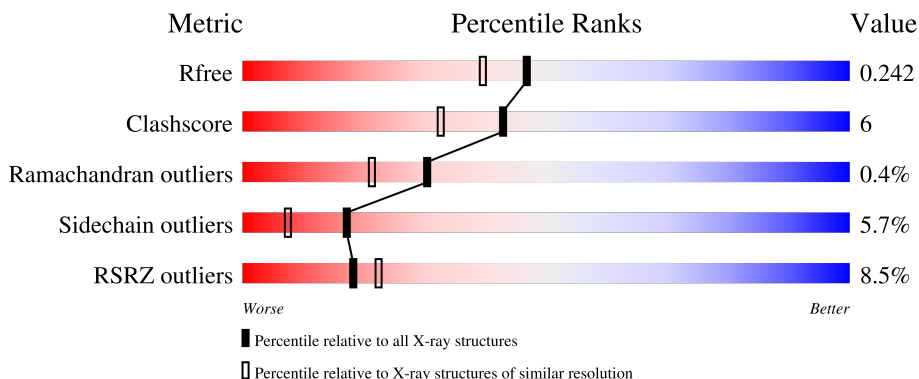

The reported resolution of this entry is 1.95 Å.

Percentile scores (ranging between 0-100) for global validation metrics of the entry are shown in the following graphic. The table shows the number of entries on which the scores are based.

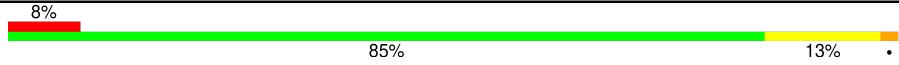

Metric	Whole archive (#Entries)	Similar resolution (#Entries, resolution range(Å))
$R_{free}$	164625	3187 (1.96-1.96)
Clashscore	180529	3412 (1.96-1.96)
Ramachandran outliers	177936	3390 (1.96-1.96)
Sidechain outliers	177891	3390 (1.96-1.96)
RSRZ outliers	164620	3186 (1.96-1.96)

The table below summarises the geometric issues observed across the polymeric chains and their fit to the electron density. The red, orange, yellow and green segments of the lower bar indicate the fraction of residues that contain outliers for  $\geq 3$ , 2, 1 and 0 types of geometric quality criteria respectively. A grey segment represents the fraction of residues that are not modelled. The numeric value for each fraction is indicated below the corresponding segment, with a dot representing fractions  $\leq 5\%$ . The upper red bar (where present) indicates the fraction of residues that have poor fit to the electron density. The numeric value is given above the bar.

Mol	Chain	Length	Quality of chain
1	A	273	
1	B	273	
1	C	273	
1	D	273	

## 2 Entry composition

There are 3 unique types of molecules in this entry. The entry contains 8809 atoms, of which 0 are hydrogens and 0 are deuteriums.

In the tables below, the ZeroOcc column contains the number of atoms modelled with zero occupancy, the AltConf column contains the number of residues with at least one atom in alternate conformation and the Trace column contains the number of residues modelled with at most 2 atoms.

- Molecule 1 is a protein called Sts-2 protein.

Mol	Chain	Residues	Atoms					ZeroOcc	AltConf	Trace
			Total	C	N	O	S			
1	A	273	2170	1371	382	400	17	0	7	0
1	B	264	2107	1331	378	382	16	0	3	0
1	C	263	2096	1326	371	383	16	0	3	0
1	D	265	2112	1335	376	386	15	0	3	0

There are 20 discrepancies between the modelled and reference sequences:

Chain	Residue	Modelled	Actual	Comment	Reference
A	350	ALA	-	expression tag	UNP Q8BX41
A	351	MET	-	expression tag	UNP Q8BX41
A	352	GLY	-	expression tag	UNP Q8BX41
A	353	SER	-	expression tag	UNP Q8BX41
A	364	ILE	VAL	conflict	UNP Q8BX41
B	350	ALA	-	expression tag	UNP Q8BX41
B	351	MET	-	expression tag	UNP Q8BX41
B	352	GLY	-	expression tag	UNP Q8BX41
B	353	SER	-	expression tag	UNP Q8BX41
B	364	ILE	VAL	conflict	UNP Q8BX41
C	350	ALA	-	expression tag	UNP Q8BX41
C	351	MET	-	expression tag	UNP Q8BX41
C	352	GLY	-	expression tag	UNP Q8BX41
C	353	SER	-	expression tag	UNP Q8BX41
C	364	ILE	VAL	conflict	UNP Q8BX41
D	350	ALA	-	expression tag	UNP Q8BX41
D	351	MET	-	expression tag	UNP Q8BX41
D	352	GLY	-	expression tag	UNP Q8BX41
D	353	SER	-	expression tag	UNP Q8BX41
D	364	ILE	VAL	conflict	UNP Q8BX41

- Molecule 2 is CHLORIDE ION (three-letter code: CL) (formula: Cl).

Mol	Chain	Residues	Atoms		ZeroOcc	AltConf
2	B	1	Total 1	Cl 1	0	0

- Molecule 3 is water.

Mol	Chain	Residues	Atoms		ZeroOcc	AltConf
3	A	105	Total 105	O 105	0	0
3	B	54	Total 54	O 54	0	0
3	C	89	Total 89	O 89	0	0
3	D	75	Total 75	O 75	0	0

### 3 Residue-property plots [i](#)

These plots are drawn for all protein, RNA, DNA and oligosaccharide chains in the entry. The first graphic for a chain summarises the proportions of the various outlier classes displayed in the second graphic. The second graphic shows the sequence view annotated by issues in geometry and electron density. Residues are color-coded according to the number of geometric quality criteria for which they contain at least one outlier: green = 0, yellow = 1, orange = 2 and red = 3 or more. A red dot above a residue indicates a poor fit to the electron density ( $RSRZ > 2$ ). Stretches of 2 or more consecutive residues without any outlier are shown as a green connector. Residues present in the sample, but not in the model, are shown in grey.

- Molecule 1: Sts-2 protein

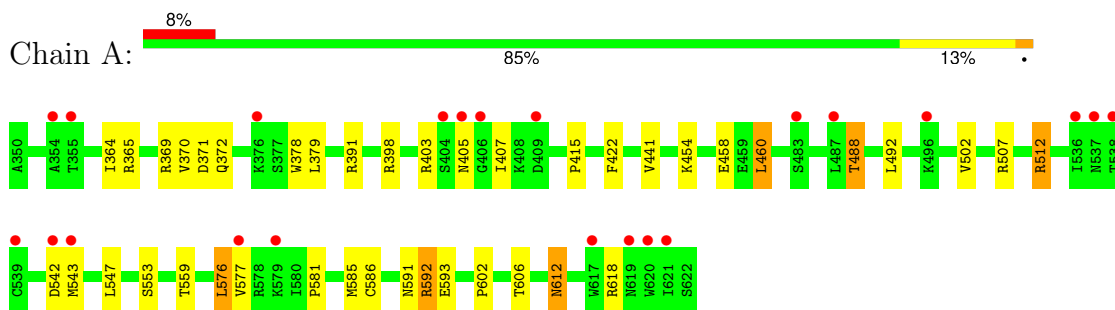

- Molecule 1: Sts-2 protein

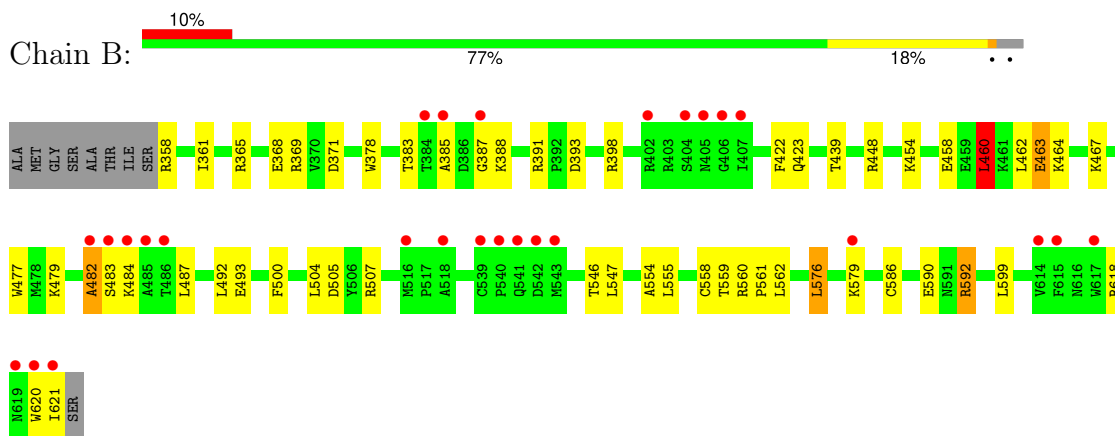

- Molecule 1: Sts-2 protein

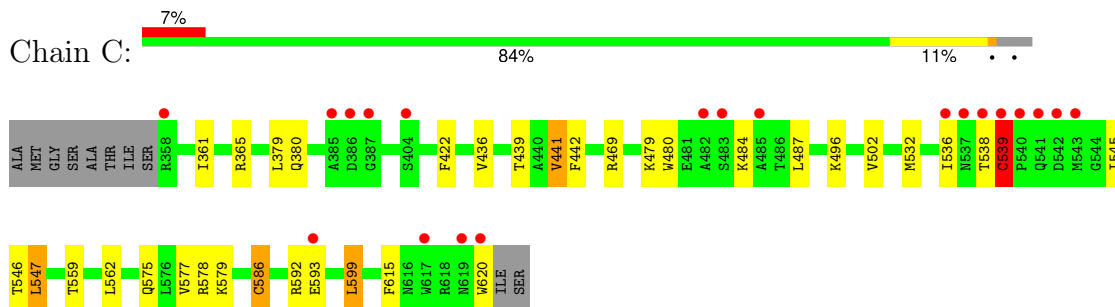

- Molecule 1: Sts-2 protein

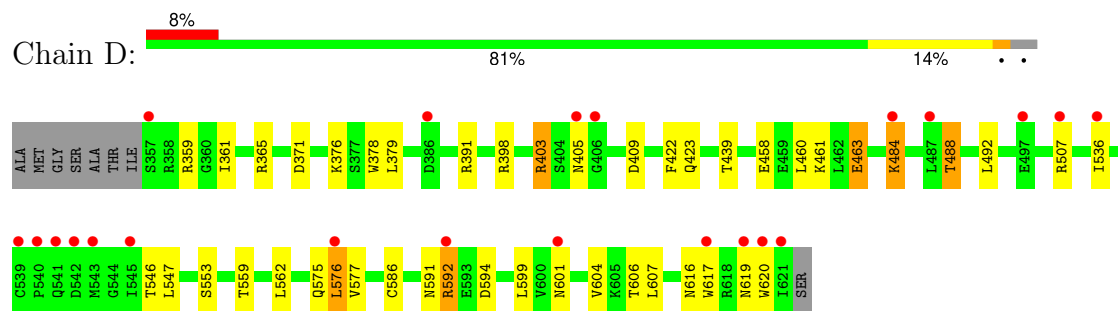

## 4 Data and refinement statistics i

Property	Value	Source
Space group	P 21 21 21	Depositor
Cell constants a, b, c, $\alpha$ , $\beta$ , $\gamma$	77.89Å 115.71Å 121.22Å 90.00° 90.00° 90.00°	Depositor
Resolution (Å)	44.19 – 1.95 44.19 – 1.95	Depositor EDS
% Data completeness (in resolution range)	99.7 (44.19-1.95) 99.7 (44.19-1.95)	Depositor EDS
$R_{merge}$	(Not available)	Depositor
$R_{sym}$	0.08	Depositor
$\langle I/\sigma(I) \rangle$ <sup>1</sup>	5.00 (at 1.95Å)	Xtrriage
Refinement program	REFMAC 5.2.0019	Depositor
R, $R_{free}$	0.208 , 0.248 0.205 , 0.242	Depositor DCC
$R_{free}$ test set	4009 reflections (5.02%)	wwPDB-VP
Wilson B-factor (Å <sup>2</sup> )	26.7	Xtrriage
Anisotropy	0.478	Xtrriage
Bulk solvent $k_{sol}$ (e/Å <sup>3</sup> ), $B_{sol}$ (Å <sup>2</sup> )	0.36 , 39.7	EDS
L-test for twinning <sup>2</sup>	$\langle  L  \rangle = 0.50$ , $\langle L^2 \rangle = 0.34$	Xtrriage
Estimated twinning fraction	0.000 for -h,l,k	Xtrriage
$F_o, F_c$ correlation	0.95	EDS
Total number of atoms	8809	wwPDB-VP
Average B, all atoms (Å <sup>2</sup> )	28.0	wwPDB-VP

Xtrriage's analysis on translational NCS is as follows: *The analyses of the Patterson function reveals a significant off-origin peak that is 22.30 % of the origin peak, indicating pseudo-translational symmetry. The chance of finding a peak of this or larger height randomly in a structure without pseudo-translational symmetry is equal to 5.8590e-03. The detected translational NCS is most likely also responsible for the elevated intensity ratio.*

<sup>1</sup>Intensities estimated from amplitudes.

<sup>2</sup>Theoretical values of  $\langle |L| \rangle$ ,  $\langle L^2 \rangle$  for acentric reflections are 0.5, 0.333 respectively for untwinned datasets, and 0.375, 0.2 for perfectly twinned datasets.

## 5 Model quality [i](#)

### 5.1 Standard geometry [i](#)

Bond lengths and bond angles in the following residue types are not validated in this section:  
CL

The Z score for a bond length (or angle) is the number of standard deviations the observed value is removed from the expected value. A bond length (or angle) with  $|Z| > 5$  is considered an outlier worth inspection. RMSZ is the root-mean-square of all Z scores of the bond lengths (or angles).

Mol	Chain	Bond lengths		Bond angles	
		RMSZ	# Z  >5	RMSZ	# Z  >5
1	A	0.60	0/2256	0.68	2/3055 (0.1%)
1	B	0.51	0/2172	0.63	1/2941 (0.0%)
1	C	0.63	2/2158 (0.1%)	0.68	0/2924
1	D	0.56	0/2177	0.64	0/2949
All	All	0.58	2/8763 (0.0%)	0.66	3/11869 (0.0%)

All (2) bond length outliers are listed below:

Mol	Chain	Res	Type	Atoms	Z	Observed(Å)	Ideal(Å)
1	C	586[A]	CYS	CB-SG	-7.39	1.69	1.82
1	C	586[B]	CYS	CB-SG	-7.39	1.69	1.82

All (3) bond angle outliers are listed below:

Mol	Chain	Res	Type	Atoms	Z	Observed(°)	Ideal(°)
1	B	460	LEU	CA-CB-CG	5.64	128.27	115.30
1	A	460	LEU	CA-CB-CG	5.61	128.20	115.30
1	A	365	ARG	NE-CZ-NH2	-5.31	117.65	120.30

There are no chirality outliers.

There are no planarity outliers.

### 5.2 Too-close contacts [i](#)

In the following table, the Non-H and H(model) columns list the number of non-hydrogen atoms and hydrogen atoms in the chain respectively. The H(added) column lists the number of hydrogen atoms added and optimized by MolProbity. The Clashes column lists the number of clashes within the asymmetric unit, whereas Symm-Clashes lists symmetry-related clashes.



Mol	Chain	Non-H	H(model)	H(added)	Clashes	Symm-Clashes
1	A	2170	0	2168	34	0
1	B	2107	0	2107	34	0
1	C	2096	0	2094	18	0
1	D	2112	0	2110	30	0
2	B	1	0	0	0	0
3	A	105	0	0	3	0
3	B	54	0	0	0	0
3	C	89	0	0	0	0
3	D	75	0	0	1	0
All	All	8809	0	8479	103	0

The all-atom clashscore is defined as the number of clashes found per 1000 atoms (including hydrogen atoms). The all-atom clashscore for this structure is 6.

All (103) close contacts within the same asymmetric unit are listed below, sorted by their clash magnitude.

Atom-1	Atom-2	Interatomic distance (Å)	Clash overlap (Å)
1:D:376:LYS:O	1:D:376:LYS:HD3	1.69	0.93
1:A:585[B]:MET:HE3	1:A:602:PRO:HB3	1.52	0.90
1:A:492:LEU:HD22	1:A:502:VAL:HG11	1.65	0.79
1:A:369:ARG:HG3	1:A:372[B]:GLN:HG3	1.63	0.78
1:A:369:ARG:CG	1:A:372[B]:GLN:HG3	2.13	0.77
1:C:532:MET:O	1:C:536:ILE:HG12	1.87	0.75
1:B:586[A]:CYS:SG	1:B:599:LEU:HD21	2.32	0.70
1:A:512:ARG:HD2	3:A:128:HOH:O	1.90	0.70
1:C:586[B]:CYS:SG	1:C:599:LEU:HD21	2.33	0.69
1:B:393:ASP:OD2	1:D:606:THR:HG23	1.93	0.68
1:D:458:GLU:HA	1:D:463:GLU:CG	2.24	0.67
1:A:543[B]:MET:CE	1:A:592:ARG:HH21	2.06	0.67
1:A:403:ARG:NH2	1:A:488:THR:O	2.28	0.67
1:B:482:ALA:O	1:B:483:SER:OG	2.14	0.65
1:A:543[B]:MET:HE1	1:A:592:ARG:HH21	1.62	0.65
1:B:586[B]:CYS:SG	1:D:617:TRP:CG	2.89	0.64
1:D:403:ARG:NH2	1:D:488:THR:O	2.30	0.64
1:D:458:GLU:HG2	1:D:463:GLU:HG2	1.79	0.63
1:C:441:VAL:HB	1:C:547:LEU:HB2	1.81	0.63
1:D:391:ARG:HD2	1:D:398:ARG:HA	1.81	0.62
1:C:578:ARG:HG3	1:C:579:LYS:HG3	1.82	0.61
1:D:484:LYS:HD2	1:D:484:LYS:H	1.67	0.59
1:D:616:ASN:HD22	1:D:619:ASN:H	1.50	0.58
1:D:592:ARG:H	1:D:592:ARG:HD2	1.69	0.58
1:D:458:GLU:HA	1:D:463:GLU:HG3	1.85	0.57

*Continued on next page...*

*Continued from previous page...*

Atom-1	Atom-2	Interatomic distance (Å)	Clash overlap (Å)
1:D:484:LYS:HD2	1:D:484:LYS:N	2.20	0.57
1:B:618:ARG:NH2	1:D:601:ASN:HD21	2.04	0.56
1:A:586:CYS:HG	1:C:620:TRP:HH2	1.50	0.56
1:D:458:GLU:HA	1:D:463:GLU:HG2	1.87	0.56
1:D:361:ILE:HD13	1:D:546:THR:HB	1.89	0.55
1:C:559:THR:HG21	1:C:586[B]:CYS:SG	2.46	0.55
1:C:496:LYS:HE2	1:C:502:VAL:O	2.06	0.55
1:A:369:ARG:HG2	1:A:372[B]:GLN:HG3	1.88	0.54
1:A:585[B]:MET:HE2	3:A:246:HOH:O	2.08	0.54
1:B:482:ALA:HB3	1:B:487:LEU:HB2	1.89	0.53
1:A:581:PRO:HG3	1:C:615:PHE:HB2	1.91	0.53
1:B:458:GLU:HG2	1:B:463:GLU:HG2	1.91	0.53
1:B:454:LYS:HE3	1:B:500:PHE:CE1	2.44	0.53
1:A:370[B]:VAL:HG23	1:A:415:PRO:O	2.09	0.52
1:A:543[B]:MET:HE1	1:A:592:ARG:NH2	2.25	0.52
1:B:555:LEU:HD23	1:B:586[B]:CYS:SG	2.49	0.52
1:A:591:ASN:OD1	1:A:593:GLU:HB2	2.10	0.52
1:A:542:ASP:O	1:A:543[B]:MET:HE2	2.10	0.51
1:B:371:ASP:HB3	1:B:378:TRP:CD1	2.45	0.51
1:A:612:ASN:C	1:A:612:ASN:HD22	2.14	0.51
1:D:484:LYS:H	1:D:484:LYS:CD	2.23	0.51
1:D:559:THR:HG21	1:D:586:CYS:SG	2.50	0.51
1:B:458:GLU:HA	1:B:463:GLU:CG	2.41	0.51
1:D:405:ASN:HB2	1:D:409:ASP:OD2	2.11	0.50
1:D:458:GLU:CG	1:D:463:GLU:HG2	2.41	0.50
1:A:585[B]:MET:HE3	1:A:602:PRO:CB	2.35	0.50
1:A:441:VAL:HB	1:A:547:LEU:HB2	1.92	0.50
1:B:576:LEU:HD23	1:D:620:TRP:CD1	2.47	0.50
1:B:592:ARG:HB2	1:B:592:ARG:CZ	2.41	0.49
1:B:458:GLU:HA	1:B:463:GLU:HG2	1.94	0.49
1:A:606:THR:HG21	1:C:615:PHE:O	2.13	0.49
1:A:559:THR:HG21	1:A:586:CYS:SG	2.53	0.49
1:A:618:ARG:HG2	1:C:599:LEU:HD13	1.95	0.49
1:D:365:ARG:CZ	3:D:22:HOH:O	2.61	0.49
1:D:423:GLN:HG2	1:D:607[A]:LEU:HD21	1.95	0.48
1:B:358:ARG:HD3	1:B:590:GLU:O	2.13	0.48
1:D:359:ARG:NH2	1:D:536:ILE:O	2.45	0.47
1:A:586:CYS:SG	1:C:620:TRP:HH2	2.37	0.47
1:B:460:LEU:O	1:B:462:LEU:HD13	2.15	0.47
1:B:361:ILE:HD13	1:B:546:THR:HB	1.97	0.46
1:B:368:GLU:H	1:B:423:GLN:NE2	2.14	0.46

*Continued on next page...*

*Continued from previous page...*

Atom-1	Atom-2	Interatomic distance (Å)	Clash overlap (Å)
1:C:479:LYS:HD3	1:C:480:TRP:CD1	2.51	0.46
1:B:559:THR:HG21	1:B:586[A]:CYS:SG	2.55	0.46
1:B:621:ILE:HG22	1:D:599:LEU:HD11	1.96	0.46
1:B:493:GLU:H	1:B:493:GLU:CD	2.17	0.46
1:B:368:GLU:H	1:B:423:GLN:HE22	1.62	0.46
1:B:391:ARG:HD2	1:B:398:ARG:HA	1.98	0.46
1:D:371:ASP:HB3	1:D:378:TRP:CD1	2.50	0.46
1:A:585[B]:MET:CE	1:A:602:PRO:HB3	2.34	0.45
1:A:371:ASP:HB3	1:A:378:TRP:CD1	2.52	0.45
1:B:560:ARG:N	1:B:561:PRO:HD2	2.31	0.45
1:B:369:ARG:HG2	1:B:448:ARG:HD2	1.99	0.45
1:D:361:ILE:HG13	1:D:562:LEU:HD21	1.99	0.44
1:C:575:GLN:O	1:C:578:ARG:HG2	2.17	0.44
1:A:553:SER:HA	1:A:577:VAL:HG11	2.00	0.44
1:C:538:THR:O	1:C:539:CYS:HB2	2.19	0.43
1:C:442:PHE:CE2	1:C:469:ARG:HD2	2.54	0.43
1:B:554:ALA:O	1:B:558:CYS:HB2	2.18	0.43
1:B:385:ALA:C	1:B:387:GLY:H	2.21	0.42
1:B:492:LEU:HD23	1:B:504:LEU:HA	2.00	0.42
1:C:361:ILE:HD13	1:C:546:THR:HB	2.01	0.42
1:D:553:SER:HA	1:D:577:VAL:HG22	2.01	0.42
1:B:460:LEU:HG	1:B:462:LEU:HD22	2.01	0.42
1:B:383:THR:HA	1:B:388:LYS:O	2.20	0.42
1:A:372[A]:GLN:NE2	3:A:80:HOH:O	2.52	0.42
1:A:454:LYS:HE2	1:A:458:GLU:OE2	2.20	0.42
1:B:620:TRP:HB3	1:D:576:LEU:HD11	2.01	0.42
1:B:618:ARG:HH22	1:D:601:ASN:HD21	1.68	0.42
1:A:576:LEU:HD11	1:C:620:TRP:HB3	2.02	0.41
1:B:454:LYS:HE3	1:B:500:PHE:CD1	2.55	0.41
1:B:477:TRP:CZ2	1:B:479:LYS:HD3	2.55	0.41
1:A:369:ARG:HG2	1:A:372[B]:GLN:OE1	2.20	0.41
1:C:436:VAL:HB	1:C:545:ILE:HD12	2.01	0.41
1:D:591:ASN:HB3	1:D:594:ASP:OD1	2.21	0.40
1:A:379:LEU:HD11	1:A:407:ILE:HG12	2.03	0.40
1:A:391:ARG:HD2	1:A:398:ARG:HA	2.03	0.40

There are no symmetry-related clashes.

## 5.3 Torsion angles [i](#)

### 5.3.1 Protein backbone [i](#)

In the following table, the Percentiles column shows the percent Ramachandran outliers of the chain as a percentile score with respect to all X-ray entries followed by that with respect to entries of similar resolution.

The Analysed column shows the number of residues for which the backbone conformation was analysed, and the total number of residues.

Mol	Chain	Analysed	Favoured	Allowed	Outliers	Percentiles	
1	A	278/273 (102%)	275 (99%)	3 (1%)	0	100	100
1	B	265/273 (97%)	253 (96%)	10 (4%)	2 (1%)	16	8
1	C	264/273 (97%)	255 (97%)	7 (3%)	2 (1%)	16	8
1	D	266/273 (97%)	262 (98%)	4 (2%)	0	100	100
All	All	1073/1092 (98%)	1045 (97%)	24 (2%)	4 (0%)	30	21

All (4) Ramachandran outliers are listed below:

Mol	Chain	Res	Type
1	B	482	ALA
1	B	484	LYS
1	C	539	CYS
1	C	484	LYS

### 5.3.2 Protein sidechains [i](#)

In the following table, the Percentiles column shows the percent sidechain outliers of the chain as a percentile score with respect to all X-ray entries followed by that with respect to entries of similar resolution.

The Analysed column shows the number of residues for which the sidechain conformation was analysed, and the total number of residues.

Mol	Chain	Analysed	Rotameric	Outliers	Percentiles	
1	A	244/237 (103%)	235 (96%)	9 (4%)	29	19
1	B	234/237 (99%)	220 (94%)	14 (6%)	16	6
1	C	233/237 (98%)	219 (94%)	14 (6%)	16	6
1	D	235/237 (99%)	219 (93%)	16 (7%)	13	4
All	All	946/948 (100%)	893 (94%)	53 (6%)	17	8

All (53) residues with a non-rotameric sidechain are listed below:

Mol	Chain	Res	Type
1	A	405	ASN
1	A	422	PHE
1	A	460	LEU
1	A	488	THR
1	A	507	ARG
1	A	512	ARG
1	A	576	LEU
1	A	592	ARG
1	A	612	ASN
1	B	365	ARG
1	B	422	PHE
1	B	439	THR
1	B	460	LEU
1	B	463	GLU
1	B	464	LYS
1	B	467	LYS
1	B	505	ASP
1	B	507	ARG
1	B	547	LEU
1	B	562	LEU
1	B	576	LEU
1	B	579	LYS
1	B	592	ARG
1	C	365	ARG
1	C	379	LEU
1	C	380	GLN
1	C	422	PHE
1	C	439	THR
1	C	441	VAL
1	C	487	LEU
1	C	539	CYS
1	C	547	LEU
1	C	562	LEU
1	C	577	VAL
1	C	592	ARG
1	C	593	GLU
1	C	599	LEU
1	D	379	LEU
1	D	403	ARG
1	D	422	PHE
1	D	439	THR
1	D	460	LEU

*Continued on next page...*

*Continued from previous page...*

Mol	Chain	Res	Type
1	D	461	LYS
1	D	463	GLU
1	D	484	LYS
1	D	488	THR
1	D	492	LEU
1	D	507	ARG
1	D	547	LEU
1	D	575	GLN
1	D	576	LEU
1	D	592	ARG
1	D	604	VAL

Sometimes sidechains can be flipped to improve hydrogen bonding and reduce clashes. All (7) such sidechains are listed below:

Mol	Chain	Res	Type
1	A	575	GLN
1	A	612	ASN
1	B	423	GLN
1	C	380	GLN
1	D	601	ASN
1	D	612	ASN
1	D	616	ASN

### 5.3.3 RNA [i](#)

There are no RNA molecules in this entry.

### 5.4 Non-standard residues in protein, DNA, RNA chains [i](#)

There are no non-standard protein/DNA/RNA residues in this entry.

### 5.5 Carbohydrates [i](#)

There are no oligosaccharides in this entry.

### 5.6 Ligand geometry [i](#)

Of 1 ligands modelled in this entry, 1 is monoatomic - leaving 0 for Mogul analysis.

There are no bond length outliers.

There are no bond angle outliers.

There are no chirality outliers.

There are no torsion outliers.

There are no ring outliers.

No monomer is involved in short contacts.

## 5.7 Other polymers [i](#)

There are no such residues in this entry.

## 5.8 Polymer linkage issues [i](#)

There are no chain breaks in this entry.

## 6 Fit of model and data [i](#)

### 6.1 Protein, DNA and RNA chains [i](#)

In the following table, the column labelled ‘#RSRZ > 2’ contains the number (and percentage) of RSRZ outliers, followed by percent RSRZ outliers for the chain as percentile scores relative to all X-ray entries and entries of similar resolution. The OWAB column contains the minimum, median, 95<sup>th</sup> percentile and maximum values of the occupancy-weighted average B-factor per residue. The column labelled ‘Q < 0.9’ lists the number of (and percentage) of residues with an average occupancy less than 0.9.

Mol	Chain	Analysed	<RSRZ>	#RSRZ>2	OWAB(Å <sup>2</sup> )	Q<0.9
1	A	273/273 (100%)	0.24	22 (8%) 19 24	13, 24, 42, 49	7 (2%)
1	B	264/273 (96%)	0.88	27 (10%) 13 17	8, 31, 47, 58	7 (2%)
1	C	263/273 (96%)	0.25	20 (7%) 21 26	12, 26, 42, 59	3 (1%)
1	D	265/273 (97%)	0.32	22 (8%) 19 23	16, 25, 46, 60	3 (1%)
All	All	1065/1092 (97%)	0.42	91 (8%) 18 22	8, 26, 44, 60	20 (1%)

All (91) RSRZ outliers are listed below:

Mol	Chain	Res	Type	RSRZ
1	B	482	ALA	33.2
1	B	485	ALA	22.0
1	B	484	LYS	15.6
1	B	483	SER	15.1
1	D	620	TRP	6.3
1	C	540	PRO	5.8
1	B	540	PRO	5.4
1	B	620	TRP	5.2
1	C	620	TRP	4.8
1	B	621	ILE	4.5
1	D	540	PRO	4.4
1	D	621	ILE	4.3
1	B	543	MET	4.1
1	A	620	TRP	4.1
1	D	539	CYS	4.0
1	B	541	GLN	4.0
1	D	619	ASN	3.9
1	C	617	TRP	3.8
1	C	543	MET	3.8
1	B	539	CYS	3.4
1	A	404	SER	3.4

*Continued on next page...*



*Continued from previous page...*

<b>Mol</b>	<b>Chain</b>	<b>Res</b>	<b>Type</b>	<b>RSRZ</b>
1	B	385	ALA	3.3
1	C	404	SER	3.3
1	B	486	THR	3.3
1	C	482	ALA	3.2
1	B	614	VAL	3.2
1	B	617	TRP	3.2
1	C	542	ASP	3.1
1	A	539	CYS	3.1
1	A	621	ILE	3.1
1	B	619	ASN	3.0
1	B	404	SER	3.0
1	C	386	ASP	3.0
1	A	536	ILE	2.9
1	B	384	THR	2.9
1	B	615	PHE	2.9
1	A	405	ASN	2.9
1	A	406	GLY	2.8
1	C	483	SER	2.8
1	A	538	THR	2.8
1	C	538	THR	2.8
1	A	376	LYS	2.8
1	C	385	ALA	2.7
1	C	539	CYS	2.7
1	D	406	GLY	2.7
1	C	536	ILE	2.7
1	B	542	ASP	2.7
1	C	619	ASN	2.6
1	B	406	GLY	2.6
1	B	402[A]	ARG	2.6
1	C	541	GLN	2.6
1	D	536	ILE	2.5
1	D	542	ASP	2.5
1	A	537	ASN	2.5
1	A	617	TRP	2.5
1	A	543[A]	MET	2.4
1	A	487	LEU	2.4
1	A	483	SER	2.4
1	A	542	ASP	2.4
1	A	355	THR	2.4
1	C	593	GLU	2.4
1	D	487	LEU	2.3
1	B	407	ILE	2.3

*Continued on next page...*

*Continued from previous page...*

Mol	Chain	Res	Type	RSRZ
1	B	518	ALA	2.3
1	D	617	TRP	2.3
1	C	358	ARG	2.3
1	A	619	ASN	2.3
1	A	579	LYS	2.3
1	D	405	ASN	2.3
1	D	543	MET	2.3
1	D	484	LYS	2.2
1	D	541	GLN	2.2
1	A	577	VAL	2.2
1	B	579	LYS	2.1
1	C	387	GLY	2.1
1	D	497	GLU	2.1
1	C	485	ALA	2.1
1	D	545	ILE	2.1
1	A	496	LYS	2.1
1	D	592	ARG	2.1
1	A	354	ALA	2.1
1	A	409	ASP	2.1
1	B	387	GLY	2.1
1	B	405	ASN	2.1
1	D	386	ASP	2.0
1	D	576	LEU	2.0
1	D	357	SER	2.0
1	D	601	ASN	2.0
1	D	507	ARG	2.0
1	B	516	MET	2.0
1	C	537	ASN	2.0

## 6.2 Non-standard residues in protein, DNA, RNA chains [i](#)

There are no non-standard protein/DNA/RNA residues in this entry.

## 6.3 Carbohydrates [i](#)

There are no monosaccharides in this entry.

## 6.4 Ligands [i](#)

In the following table, the Atoms column lists the number of modelled atoms in the group and the number defined in the chemical component dictionary. The B-factors column lists the minimum,

median, 95<sup>th</sup> percentile and maximum values of B factors of atoms in the group. The column labelled 'Q< 0.9' lists the number of atoms with occupancy less than 0.9.

Mol	Type	Chain	Res	Atoms	RSCC	RSR	B-factors(Å <sup>2</sup> )	Q<0.9
2	CL	B	1	1/1	0.86	0.20	63,63,63,63	0

## 6.5 Other polymers [i](#)

There are no such residues in this entry.