



# Full wwPDB X-ray Structure Validation Report ⓘ

Aug 22, 2023 – 11:57 PM EDT

PDB ID : 3C51  
Title : Crystal structure of G protein coupled receptor kinase 1 bound to ADP and magnesium chloride at 3.55Å  
Authors : Singh, P.; Tesmer, J.J.G.  
Deposited on : 2008-01-30  
Resolution : 3.55 Å(reported)

This is a Full wwPDB X-ray Structure Validation Report for a publicly released PDB entry.

We welcome your comments at [validation@mail.wwpdb.org](mailto:validation@mail.wwpdb.org)

A user guide is available at

<https://www.wwpdb.org/validation/2017/XrayValidationReportHelp>

with specific help available everywhere you see the ⓘ symbol.

The types of validation reports are described at

<http://www.wwpdb.org/validation/2017/FAQs#types>.

---

The following versions of software and data (see [references ⓘ](#)) were used in the production of this report:

MolProbity : 4.02b-467  
Mogul : 1.8.5 (274361), CSD as541be (2020)  
Xtriage (Phenix) : 1.13  
EDS : 2.35  
buster-report : 1.1.7 (2018)  
Percentile statistics : 20191225.v01 (using entries in the PDB archive December 25th 2019)  
Refmac : 5.8.0158  
CCP4 : 7.0.044 (Gargrove)  
Ideal geometry (proteins) : Engh & Huber (2001)  
Ideal geometry (DNA, RNA) : Parkinson et al. (1996)  
Validation Pipeline (wwPDB-VP) : 2.35

# 1 Overall quality at a glance

The following experimental techniques were used to determine the structure:

*X-RAY DIFFRACTION*

The reported resolution of this entry is 3.55 Å.

Percentile scores (ranging between 0-100) for global validation metrics of the entry are shown in the following graphic. The table shows the number of entries on which the scores are based.

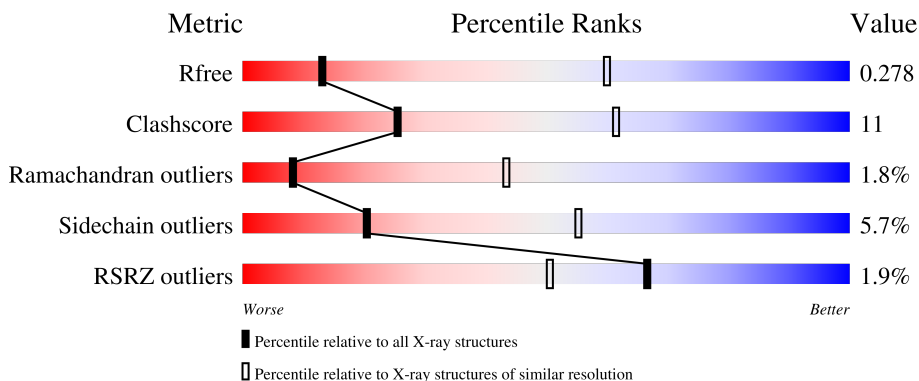

Metric	Whole archive (#Entries)	Similar resolution (#Entries, resolution range(Å))
$R_{free}$	130704	1020 (3.62-3.50)
Clashscore	141614	1100 (3.62-3.50)
Ramachandran outliers	138981	1065 (3.62-3.50)
Sidechain outliers	138945	1066 (3.62-3.50)
RSRZ outliers	127900	1009 (3.64-3.48)

The table below summarises the geometric issues observed across the polymeric chains and their fit to the electron density. The red, orange, yellow and green segments of the lower bar indicate the fraction of residues that contain outliers for  $\geq 3$ , 2, 1 and 0 types of geometric quality criteria respectively. A grey segment represents the fraction of residues that are not modelled. The numeric value for each fraction is indicated below the corresponding segment, with a dot representing fractions  $\leq 5\%$ . The upper red bar (where present) indicates the fraction of residues that have poor fit to the electron density. The numeric value is given above the bar.

Mol	Chain	Length	Quality of chain
1	A	543	 2% 64% 24% 10%
1	B	543	 2% 62% 21% 15%

## 2 Entry composition

There are 4 unique types of molecules in this entry. The entry contains 7700 atoms, of which 0 are hydrogens and 0 are deuteriums.

In the tables below, the ZeroOcc column contains the number of atoms modelled with zero occupancy, the AltConf column contains the number of residues with at least one atom in alternate conformation and the Trace column contains the number of residues modelled with at most 2 atoms.

- Molecule 1 is a protein called Rhodopsin kinase.

Mol	Chain	Residues	Atoms					ZeroOcc	AltConf	Trace
			Total	C	N	O	S			
1	A	487	3917	2514	677	707	19	0	0	0
1	B	461	3720	2390	647	664	19	0	0	0

There are 16 discrepancies between the modelled and reference sequences:

Chain	Residue	Modelled	Actual	Comment	Reference
A	536	VAL	-	expression tag	UNP P28327
A	537	ASP	-	expression tag	UNP P28327
A	538	HIS	-	expression tag	UNP P28327
A	539	HIS	-	expression tag	UNP P28327
A	540	HIS	-	expression tag	UNP P28327
A	541	HIS	-	expression tag	UNP P28327
A	542	HIS	-	expression tag	UNP P28327
A	543	HIS	-	expression tag	UNP P28327
B	536	VAL	-	expression tag	UNP P28327
B	537	ASP	-	expression tag	UNP P28327
B	538	HIS	-	expression tag	UNP P28327
B	539	HIS	-	expression tag	UNP P28327
B	540	HIS	-	expression tag	UNP P28327
B	541	HIS	-	expression tag	UNP P28327
B	542	HIS	-	expression tag	UNP P28327
B	543	HIS	-	expression tag	UNP P28327

- Molecule 2 is MAGNESIUM ION (three-letter code: MG) (formula: Mg).

Mol	Chain	Residues	Atoms		ZeroOcc	AltConf
2	A	2	Total	Mg	0	0
			2	2		
2	B	2	Total	Mg	0	0
			2	2		

- Molecule 3 is BROMIDE ION (three-letter code: BR) (formula: Br).

Mol	Chain	Residues	Atoms		ZeroOcc	AltConf
3	A	3	Total	Br	0	0
			3	3		
3	B	2	Total	Br	0	0
			2	2		

- Molecule 4 is ADENOSINE-5'-DIPHOSPHATE (three-letter code: ADP) (formula: C<sub>10</sub>H<sub>15</sub>N<sub>5</sub>O<sub>10</sub>P<sub>2</sub>).

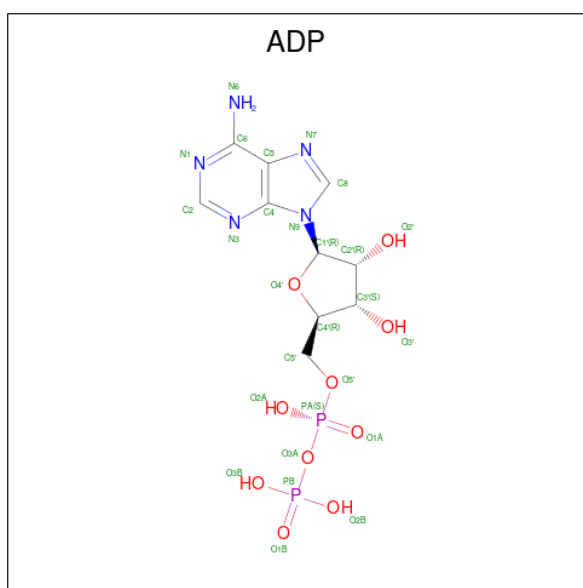

Mol	Chain	Residues	Atoms				ZeroOcc	AltConf	
4	A	1	Total	C	N	O	P	0	0
			27	10	5	10	2		
4	B	1	Total	C	N	O	P	0	0
			27	10	5	10	2		

### 3 Residue-property plots [i](#)

These plots are drawn for all protein, RNA, DNA and oligosaccharide chains in the entry. The first graphic for a chain summarises the proportions of the various outlier classes displayed in the second graphic. The second graphic shows the sequence view annotated by issues in geometry and electron density. Residues are color-coded according to the number of geometric quality criteria for which they contain at least one outlier: green = 0, yellow = 1, orange = 2 and red = 3 or more. A red dot above a residue indicates a poor fit to the electron density ( $RSRZ > 2$ ). Stretches of 2 or more consecutive residues without any outlier are shown as a green connector. Residues present in the sample, but not in the model, are shown in grey.

- Molecule 1: Rhodopsin kinase

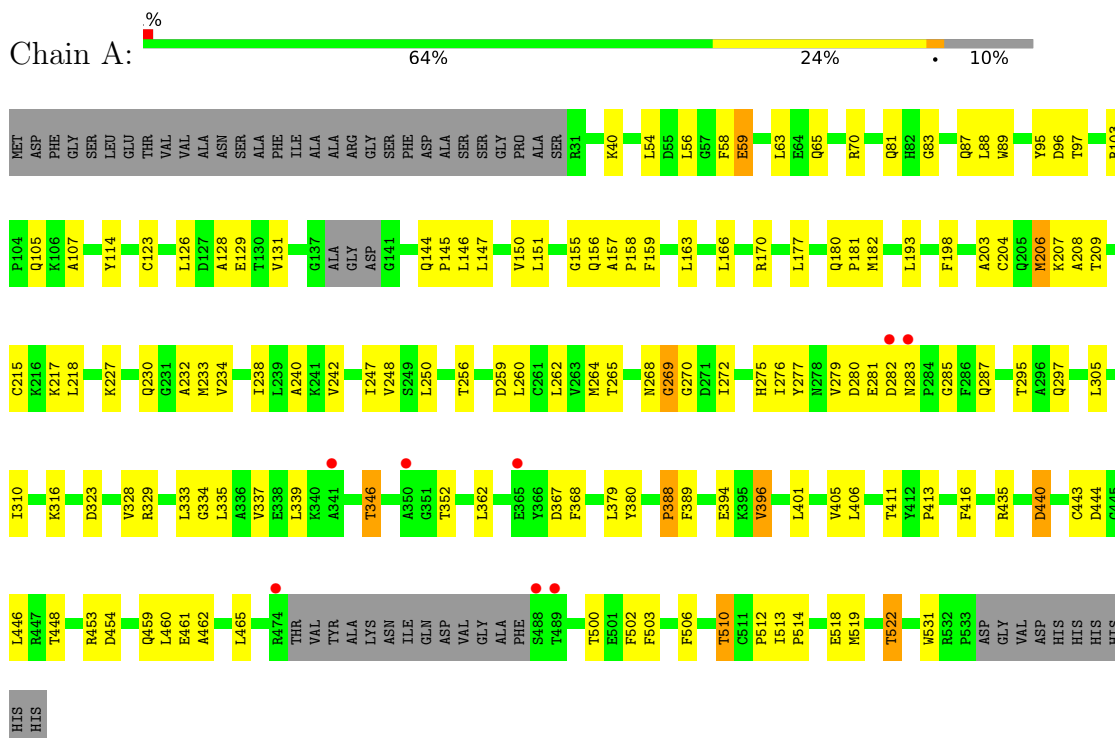

- Molecule 1: Rhodopsin kinase

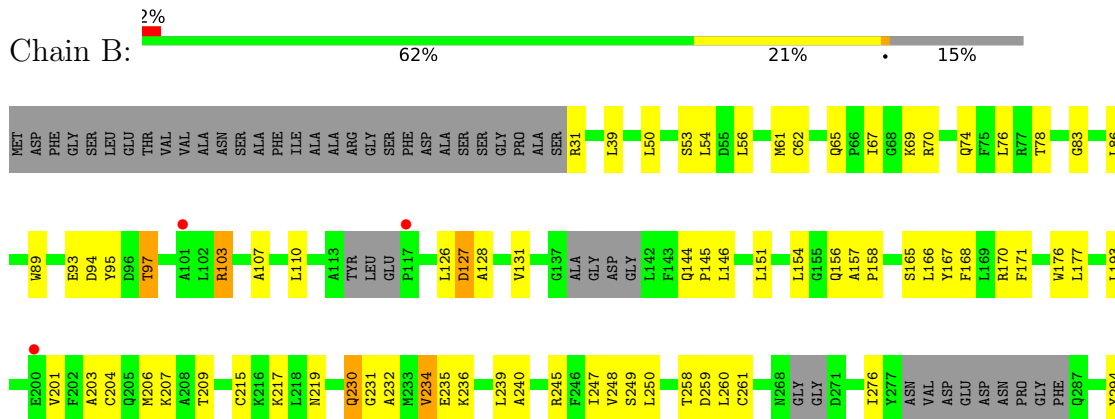

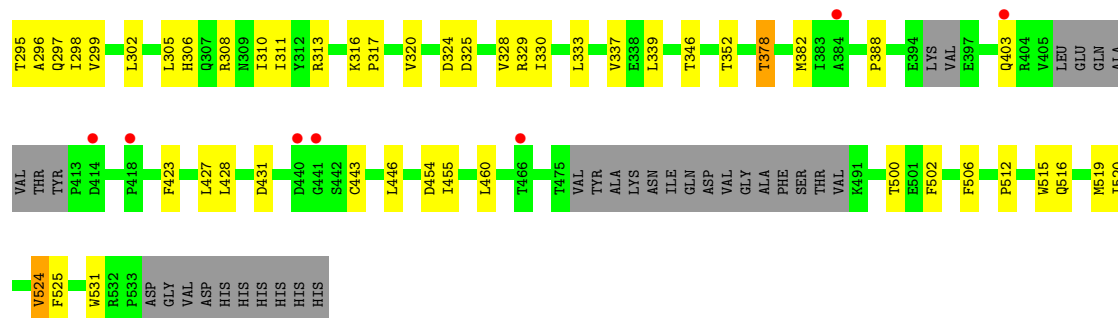

## 4 Data and refinement statistics

Property	Value	Source
Space group	P 21 21 21	Depositor
Cell constants a, b, c, $\alpha$ , $\beta$ , $\gamma$	58.66Å 92.53Å 259.38Å 90.00° 90.00° 90.00°	Depositor
Resolution (Å)	19.88 – 3.55 19.88 – 3.55	Depositor EDS
% Data completeness (in resolution range)	97.7 (19.88-3.55) 97.7 (19.88-3.55)	Depositor EDS
$R_{merge}$	(Not available)	Depositor
$R_{sym}$	(Not available)	Depositor
$\langle I/\sigma(I) \rangle$ <sup>1</sup>	2.53 (at 3.52Å)	Xtrriage
Refinement program	REFMAC 5.2.0019	Depositor
R, $R_{free}$	0.281 , (Not available) 0.252 , 0.278	Depositor DCC
$R_{free}$ test set	885 reflections (5.12%)	wwPDB-VP
Wilson B-factor (Å <sup>2</sup> )	123.3	Xtrriage
Anisotropy	0.027	Xtrriage
Bulk solvent $k_{sol}$ (e/Å <sup>3</sup> ), $B_{sol}$ (Å <sup>2</sup> )	0.29 , 129.2	EDS
L-test for twinning <sup>2</sup>	$\langle  L  \rangle = 0.47$ , $\langle L^2 \rangle = 0.30$	Xtrriage
Estimated twinning fraction	No twinning to report.	Xtrriage
$F_o, F_c$ correlation	0.91	EDS
Total number of atoms	7700	wwPDB-VP
Average B, all atoms (Å <sup>2</sup> )	133.0	wwPDB-VP

Xtrriage's analysis on translational NCS is as follows: *The largest off-origin peak in the Patterson function is 3.89% of the height of the origin peak. No significant pseudotranslation is detected.*

<sup>1</sup>Intensities estimated from amplitudes.

<sup>2</sup>Theoretical values of  $\langle |L| \rangle$ ,  $\langle L^2 \rangle$  for acentric reflections are 0.5, 0.333 respectively for untwinned datasets, and 0.375, 0.2 for perfectly twinned datasets.

## 5 Model quality

### 5.1 Standard geometry

Bond lengths and bond angles in the following residue types are not validated in this section: MG, ADP, BR

The Z score for a bond length (or angle) is the number of standard deviations the observed value is removed from the expected value. A bond length (or angle) with  $|Z| > 5$  is considered an outlier worth inspection. RMSZ is the root-mean-square of all Z scores of the bond lengths (or angles).

Mol	Chain	Bond lengths		Bond angles	
		RMSZ	# Z  >5	RMSZ	# Z  >5
1	A	0.44	0/4009	0.56	0/5405
1	B	0.40	0/3803	0.54	0/5114
All	All	0.42	0/7812	0.55	0/10519

There are no bond length outliers.

There are no bond angle outliers.

There are no chirality outliers.

There are no planarity outliers.

### 5.2 Too-close contacts

In the following table, the Non-H and H(model) columns list the number of non-hydrogen atoms and hydrogen atoms in the chain respectively. The H(added) column lists the number of hydrogen atoms added and optimized by MolProbity. The Clashes column lists the number of clashes within the asymmetric unit, whereas Symm-Clashes lists symmetry-related clashes.

Mol	Chain	Non-H	H(model)	H(added)	Clashes	Symm-Clashes
1	A	3917	0	3891	85	0
1	B	3720	0	3708	80	0
2	A	2	0	0	0	0
2	B	2	0	0	0	0
3	A	3	0	0	1	0
3	B	2	0	0	0	0
4	A	27	0	12	0	0
4	B	27	0	12	1	0
All	All	7700	0	7623	162	0

The all-atom clashscore is defined as the number of clashes found per 1000 atoms (including hydrogen atoms). The all-atom clashscore for this structure is 11.



All (162) close contacts within the same asymmetric unit are listed below, sorted by their clash magnitude.

Atom-1	Atom-2	Interatomic distance (Å)	Clash overlap (Å)
1:B:240:ALA:HB2	1:B:250:LEU:HD23	1.29	1.09
1:A:240:ALA:HB2	1:A:250:LEU:HD23	1.29	1.08
1:B:276:ILE:HD11	1:B:382:MET:HA	1.56	0.86
1:B:193:LEU:HD21	1:B:203:ALA:HB2	1.62	0.80
1:A:297:GLN:OE1	1:A:328:VAL:HG22	1.83	0.79
1:B:193:LEU:CD2	1:B:203:ALA:HB2	2.14	0.78
1:A:518:GLU:O	1:A:522:THR:OG1	2.04	0.75
1:A:56:LEU:HD13	1:A:65:GLN:HE22	1.51	0.74
1:B:193:LEU:HD12	1:B:201:VAL:HG12	1.72	0.72
1:B:297:GLN:OE1	1:B:328:VAL:HG22	1.90	0.71
1:A:238:ILE:HD13	1:A:310:ILE:HD13	1.72	0.71
1:B:76:LEU:HB2	1:B:86:LEU:HD13	1.73	0.68
1:A:63:LEU:HD21	1:A:151:LEU:HD22	1.76	0.68
1:B:298:ILE:HD11	1:B:320:VAL:HG11	1.78	0.66
1:B:209:THR:HG21	1:B:519:MET:CE	2.26	0.66
1:B:70:ARG:NH1	1:B:520:ILE:HD13	2.11	0.65
1:A:276:ILE:HG23	1:A:285:GLY:HA2	1.79	0.65
1:A:460:LEU:N	1:A:465:LEU:HD12	2.12	0.64
1:B:126:LEU:HD11	1:B:146:LEU:HD11	1.79	0.64
1:A:63:LEU:CD2	1:A:151:LEU:HD22	2.28	0.64
1:B:209:THR:HG21	1:B:519:MET:HE2	1.80	0.64
1:A:159:PHE:CE2	1:A:163:LEU:HD11	2.32	0.64
1:B:56:LEU:CD1	1:B:65:GLN:HE22	2.10	0.63
1:A:230:GLN:O	1:A:234:VAL:HG23	1.99	0.62
1:A:88:LEU:HD13	1:A:114:TYR:CB	2.29	0.62
1:A:54:LEU:HD22	1:A:56:LEU:HG	1.83	0.60
1:A:272:ILE:N	1:A:272:ILE:HD13	2.16	0.60
1:B:31:ARG:HH11	1:B:524:VAL:HG23	1.66	0.60
1:B:56:LEU:HD13	1:B:65:GLN:HE22	1.67	0.59
1:A:147:LEU:HD11	1:A:151:LEU:HD11	1.85	0.59
1:B:230:GLN:HE21	1:B:230:GLN:C	2.06	0.58
1:B:50:LEU:HD22	1:B:54:LEU:CD1	2.34	0.58
1:B:239:LEU:HD22	1:B:248:VAL:HG23	1.84	0.58
1:A:238:ILE:CD1	1:A:310:ILE:HD13	2.33	0.58
1:A:389:PHE:N	3:A:566:BR:BR	2.92	0.58
1:A:88:LEU:HD13	1:A:114:TYR:HB2	1.85	0.57
1:B:126:LEU:HB3	1:B:131:VAL:HG22	1.87	0.57
1:B:89:TRP:NE1	1:B:151:LEU:HD21	2.18	0.57
1:A:182:MET:CE	1:A:510:THR:HG21	2.35	0.57
1:A:250:LEU:HD11	1:A:262:LEU:HD22	1.87	0.57

*Continued on next page...*

*Continued from previous page...*

Atom-1	Atom-2	Interatomic distance (Å)	Clash overlap (Å)
1:B:76:LEU:CB	1:B:86:LEU:HD13	2.34	0.56
1:B:296:ALA:HB1	1:B:460:LEU:CD2	2.35	0.56
1:A:279:VAL:HG12	1:A:280:ASP:N	2.22	0.55
1:B:56:LEU:HD13	1:B:65:GLN:NE2	2.20	0.55
1:A:247:ILE:HG22	1:A:248:VAL:O	2.07	0.55
1:A:193:LEU:HG	1:A:203:ALA:HB2	1.89	0.55
1:A:88:LEU:HD11	1:A:146:LEU:HD21	1.88	0.54
1:A:157:ALA:HB3	1:A:158:PRO:HD3	1.90	0.54
1:A:394:GLU:O	1:A:396:VAL:HG13	2.08	0.54
1:B:296:ALA:HB1	1:B:460:LEU:HD21	1.89	0.54
1:A:295:THR:OG1	1:A:379:LEU:HD13	2.09	0.53
1:A:269:GLY:O	1:A:275:HIS:NE2	2.40	0.53
1:A:268:ASN:O	1:A:270:GLY:N	2.42	0.53
1:B:157:ALA:HB3	1:B:158:PRO:HD3	1.90	0.53
1:B:39:LEU:HD23	1:B:177:LEU:HD21	1.91	0.53
1:A:182:MET:HE3	1:A:510:THR:HG21	1.90	0.52
1:A:166:LEU:HD12	1:B:170:ARG:NH2	2.25	0.52
1:A:260:LEU:HD13	1:A:506:PHE:CD2	2.45	0.52
1:B:204:CYS:SG	1:B:215:CYS:HB2	2.50	0.52
1:A:334:GLY:O	1:A:335:LEU:HD23	2.10	0.51
1:A:440:ASP:N	1:A:440:ASP:OD1	2.44	0.51
1:A:247:ILE:HD11	1:A:305:LEU:HG	1.93	0.51
1:A:204:CYS:SG	1:A:215:CYS:HB2	2.51	0.50
1:A:339:LEU:CD2	1:A:346:THR:HB	2.42	0.50
1:B:316:LYS:HD3	1:B:352:THR:HG21	1.94	0.50
1:B:454:ASP:O	1:B:455:ILE:HD13	2.11	0.50
1:A:260:LEU:HD21	1:A:503:PHE:CD2	2.47	0.49
1:B:61:MET:HG3	1:B:171:PHE:CZ	2.48	0.49
1:B:31:ARG:NH1	1:B:524:VAL:HG23	2.27	0.49
1:A:59:GLU:HA	1:A:63:LEU:HD12	1.95	0.48
1:B:78:THR:HG21	1:B:167:TYR:OH	2.13	0.48
1:B:127:ASP:N	1:B:127:ASP:OD1	2.47	0.48
1:A:444:ASP:O	1:A:448:THR:HG23	2.13	0.48
1:A:156:GLN:CG	1:A:157:ALA:H	2.27	0.48
1:B:317:PRO:CD	1:B:378:THR:HG23	2.45	0.47
1:A:233:MET:HE2	1:A:502:PHE:CZ	2.50	0.47
1:A:380:TYR:CE2	1:A:388:PRO:HA	2.49	0.47
1:B:333:LEU:HD22	1:B:333:LEU:N	2.30	0.47
1:A:95:TYR:CE1	1:A:107:ALA:HB2	2.49	0.47
1:A:144:GLN:N	1:A:145:PRO:CD	2.78	0.47
1:A:443:CYS:O	1:A:446:LEU:N	2.40	0.46

*Continued on next page...*

*Continued from previous page...*

Atom-1	Atom-2	Interatomic distance (Å)	Clash overlap (Å)
1:B:168:PHE:O	1:B:171:PHE:HB3	2.16	0.46
1:A:401:LEU:O	1:A:405:VAL:HG23	2.15	0.46
1:B:245:ARG:O	1:B:329:ARG:NE	2.47	0.46
1:B:443:CYS:O	1:B:446:LEU:N	2.42	0.46
1:A:40:LYS:O	1:A:177:LEU:HD13	2.15	0.46
1:A:126:LEU:HB3	1:A:131:VAL:HG22	1.98	0.46
1:A:337:VAL:O	1:A:337:VAL:HG13	2.16	0.46
1:A:333:LEU:HD22	1:A:333:LEU:N	2.31	0.46
1:B:247:ILE:HD13	1:B:305:LEU:HD21	1.98	0.46
1:B:339:LEU:HD21	1:B:346:THR:HG22	1.98	0.46
1:A:159:PHE:CZ	1:A:163:LEU:HD21	2.51	0.45
1:A:531:TRP:HB2	1:B:531:TRP:CG	2.51	0.45
1:B:294:TYR:CD2	1:B:328:VAL:HG11	2.51	0.45
1:A:58:PHE:CE2	1:A:63:LEU:HD11	2.52	0.45
1:B:144:GLN:N	1:B:145:PRO:HD2	2.32	0.45
1:B:219:ASN:OD1	1:B:219:ASN:C	2.55	0.45
1:A:146:LEU:O	1:A:150:VAL:HG23	2.17	0.45
1:B:50:LEU:HB3	1:B:54:LEU:HD13	1.98	0.45
1:B:276:ILE:CD1	1:B:382:MET:HA	2.38	0.45
1:A:316:LYS:HD3	1:A:352:THR:HG21	1.99	0.44
1:B:65:GLN:OE1	1:B:516:GLN:NE2	2.37	0.44
1:A:156:GLN:CG	1:A:157:ALA:N	2.80	0.44
1:A:180:GLN:HB3	1:A:181:PRO:HD2	2.00	0.44
1:A:170:ARG:HH21	1:B:166:LEU:HD12	1.82	0.44
1:B:193:LEU:HD21	1:B:203:ALA:CB	2.42	0.44
1:B:193:LEU:HD13	4:B:562:ADP:C2	2.52	0.44
1:B:317:PRO:HD3	1:B:378:THR:HG23	2.00	0.44
1:B:308:ARG:O	1:B:310:ILE:HD12	2.18	0.44
1:A:367:ASP:OD1	1:A:368:PHE:N	2.51	0.43
1:B:234:VAL:HG12	1:B:235:GLU:N	2.33	0.43
1:B:423:PHE:CE2	1:B:427:LEU:HD11	2.53	0.43
1:A:89:TRP:CE2	1:A:151:LEU:HD21	2.54	0.43
1:B:67:ILE:HG23	1:B:525:PHE:CE1	2.53	0.43
1:A:88:LEU:HD22	1:A:123:CYS:SG	2.59	0.43
1:A:333:LEU:N	1:A:333:LEU:CD2	2.81	0.43
1:B:50:LEU:O	1:B:54:LEU:HB2	2.19	0.43
1:A:260:LEU:HD13	1:A:506:PHE:CG	2.53	0.43
1:B:50:LEU:HD11	1:B:176:TRP:HA	2.01	0.43
1:B:230:GLN:HE21	1:B:231:GLY:N	2.16	0.43
1:B:333:LEU:N	1:B:333:LEU:CD2	2.81	0.43
1:A:156:GLN:HG2	1:A:157:ALA:H	1.84	0.43

*Continued on next page...*

Continued from previous page...

Atom-1	Atom-2	Interatomic distance (Å)	Clash overlap (Å)
1:B:311:ILE:HG22	1:B:313:ARG:HG3	2.00	0.43
1:A:323:ASP:OD1	1:A:323:ASP:C	2.56	0.42
1:B:67:ILE:HD13	1:B:525:PHE:CD1	2.53	0.42
1:B:502:PHE:CD2	1:B:502:PHE:C	2.92	0.42
1:A:413:PRO:HD2	1:A:416:PHE:CE2	2.55	0.42
1:B:95:TYR:CE1	1:B:107:ALA:HB2	2.54	0.42
1:B:313:ARG:HE	1:B:337:VAL:HG12	1.84	0.42
1:A:513:ILE:N	1:A:514:PRO:HD2	2.35	0.42
1:A:280:ASP:O	1:A:283:ASN:N	2.52	0.42
1:B:50:LEU:HD22	1:B:54:LEU:HD11	2.00	0.42
1:A:58:PHE:CE1	1:A:155:GLY:HA2	2.55	0.42
1:B:76:LEU:HD11	1:B:154:LEU:HD22	2.02	0.42
1:A:126:LEU:CB	1:A:131:VAL:HG22	2.50	0.42
1:A:264:MET:O	1:A:265:THR:C	2.57	0.42
1:A:276:ILE:HB	1:A:277:TYR:HD1	1.85	0.42
1:B:93:GLU:O	1:B:97:THR:HG23	2.20	0.41
1:B:296:ALA:CB	1:B:460:LEU:HD21	2.51	0.41
1:A:56:LEU:HD13	1:A:65:GLN:NE2	2.27	0.41
1:A:87:GLN:HB3	1:A:114:TYR:OH	2.20	0.41
1:A:215:CYS:SG	1:A:217:LYS:NZ	2.67	0.41
1:A:334:GLY:C	1:A:335:LEU:HD23	2.40	0.41
1:B:74:GLN:O	1:B:78:THR:HG23	2.21	0.41
1:B:177:LEU:HD23	1:B:515:TRP:CH2	2.56	0.41
1:B:302:LEU:HD22	1:B:306:HIS:CE1	2.56	0.41
1:A:206:MET:O	1:A:208:ALA:N	2.54	0.41
1:B:62:CYS:O	1:B:69:LYS:HA	2.20	0.41
1:A:54:LEU:HD22	1:A:56:LEU:CG	2.50	0.41
1:A:209:THR:HG21	1:A:519:MET:HE1	2.03	0.40
1:A:242:VAL:HG21	1:A:247:ILE:HD12	2.03	0.40
1:B:50:LEU:HA	1:B:53:SER:OG	2.21	0.40
1:B:217:LYS:NZ	1:B:261:CYS:SG	2.88	0.40
1:B:39:LEU:CD2	1:B:177:LEU:HD21	2.50	0.40
1:B:110:LEU:C	1:B:110:LEU:HD23	2.42	0.40
1:B:260:LEU:HD22	1:B:506:PHE:CD2	2.56	0.40
1:A:198:PHE:HD1	1:A:218:LEU:HD22	1.87	0.40
1:A:265:THR:HG21	1:A:329:ARG:HH12	1.87	0.40
1:A:459:GLN:O	1:A:462:ALA:HB3	2.20	0.40
1:B:308:ARG:C	1:B:310:ILE:HD12	2.42	0.40
1:A:362:LEU:HG	1:A:406:LEU:HD11	2.03	0.40
1:B:295:THR:O	1:B:299:VAL:HG23	2.22	0.40

There are no symmetry-related clashes.

## 5.3 Torsion angles [i](#)

### 5.3.1 Protein backbone [i](#)

In the following table, the Percentiles column shows the percent Ramachandran outliers of the chain as a percentile score with respect to all X-ray entries followed by that with respect to entries of similar resolution.

The Analysed column shows the number of residues for which the backbone conformation was analysed, and the total number of residues.

Mol	Chain	Analysed	Favoured	Allowed	Outliers	Percentiles	
1	A	481/543 (89%)	422 (88%)	50 (10%)	9 (2%)	8	42
1	B	445/543 (82%)	400 (90%)	37 (8%)	8 (2%)	8	43
All	All	926/1086 (85%)	822 (89%)	87 (9%)	17 (2%)	8	43

All (17) Ramachandran outliers are listed below:

Mol	Chain	Res	Type
1	A	128	ALA
1	A	207	LYS
1	A	269	GLY
1	B	128	ALA
1	B	207	LYS
1	A	281	GLU
1	B	512	PRO
1	A	232	ALA
1	A	512	PRO
1	B	83	GLY
1	B	232	ALA
1	A	83	GLY
1	B	156	GLN
1	A	388	PRO
1	B	388	PRO
1	A	396	VAL
1	B	103	ARG

### 5.3.2 Protein sidechains [i](#)

In the following table, the Percentiles column shows the percent sidechain outliers of the chain as a percentile score with respect to all X-ray entries followed by that with respect to entries of similar resolution.

The Analysed column shows the number of residues for which the sidechain conformation was

analysed, and the total number of residues.

Mol	Chain	Analysed	Rotameric	Outliers	Percentiles	
1	A	408/449 (91%)	384 (94%)	24 (6%)	19	54
1	B	387/449 (86%)	366 (95%)	21 (5%)	22	57
All	All	795/898 (88%)	750 (94%)	45 (6%)	20	55

All (45) residues with a non-rotameric sidechain are listed below:

Mol	Chain	Res	Type
1	A	59	GLU
1	A	70	ARG
1	A	81	GLN
1	A	96	ASP
1	A	97	THR
1	A	103	ARG
1	A	105	GLN
1	A	129	GLU
1	A	206	MET
1	A	227	LYS
1	A	256	THR
1	A	259	ASP
1	A	282	ASP
1	A	287	GLN
1	A	346	THR
1	A	411	THR
1	A	435	ARG
1	A	440	ASP
1	A	453	ARG
1	A	454	ASP
1	A	461	GLU
1	A	500	THR
1	A	510	THR
1	A	522	THR
1	B	94	ASP
1	B	97	THR
1	B	103	ARG
1	B	127	ASP
1	B	165	SER
1	B	206	MET
1	B	230	GLN
1	B	234	VAL
1	B	236	LYS
1	B	249	SER

*Continued on next page...*

*Continued from previous page...*

Mol	Chain	Res	Type
1	B	258	THR
1	B	259	ASP
1	B	324	ASP
1	B	325	ASP
1	B	330	ILE
1	B	378	THR
1	B	403	GLN
1	B	428	LEU
1	B	431	ASP
1	B	500	THR
1	B	524	VAL

Sometimes sidechains can be flipped to improve hydrogen bonding and reduce clashes. All (13) such sidechains are listed below:

Mol	Chain	Res	Type
1	A	65	GLN
1	A	74	GLN
1	A	287	GLN
1	A	319	ASN
1	A	459	GLN
1	A	529	ASN
1	B	153	HIS
1	B	180	GLN
1	B	230	GLN
1	B	297	GLN
1	B	327	ASN
1	B	403	GLN
1	B	529	ASN

### 5.3.3 RNA [i](#)

There are no RNA molecules in this entry.

### 5.4 Non-standard residues in protein, DNA, RNA chains [i](#)

There are no non-standard protein/DNA/RNA residues in this entry.

### 5.5 Carbohydrates [i](#)

There are no monosaccharides in this entry.

## 5.6 Ligand geometry

Of 11 ligands modelled in this entry, 9 are monoatomic - leaving 2 for Mogul analysis.

In the following table, the Counts columns list the number of bonds (or angles) for which Mogul statistics could be retrieved, the number of bonds (or angles) that are observed in the model and the number of bonds (or angles) that are defined in the Chemical Component Dictionary. The Link column lists molecule types, if any, to which the group is linked. The Z score for a bond length (or angle) is the number of standard deviations the observed value is removed from the expected value. A bond length (or angle) with  $|Z| > 2$  is considered an outlier worth inspection. RMSZ is the root-mean-square of all Z scores of the bond lengths (or angles).

Mol	Type	Chain	Res	Link	Bond lengths			Bond angles		
					Counts	RMSZ	# Z  > 2	Counts	RMSZ	# Z  > 2
4	ADP	B	562	2	24,29,29	1.04	3 (12%)	29,45,45	1.37	3 (10%)
4	ADP	A	562	2	24,29,29	0.90	1 (4%)	29,45,45	1.36	4 (13%)

In the following table, the Chirals column lists the number of chiral outliers, the number of chiral centers analysed, the number of these observed in the model and the number defined in the Chemical Component Dictionary. Similar counts are reported in the Torsion and Rings columns. '-' means no outliers of that kind were identified.

Mol	Type	Chain	Res	Link	Chirals	Torsions	Rings
4	ADP	B	562	2	-	1/12/32/32	0/3/3/3
4	ADP	A	562	2	-	0/12/32/32	0/3/3/3

All (4) bond length outliers are listed below:

Mol	Chain	Res	Type	Atoms	Z	Observed(Å)	Ideal(Å)
4	B	562	ADP	C5-C4	2.31	1.47	1.40
4	B	562	ADP	O4'-C1'	2.26	1.44	1.41
4	B	562	ADP	C2-N3	2.19	1.35	1.32
4	A	562	ADP	C5-C4	2.06	1.46	1.40

All (7) bond angle outliers are listed below:

Mol	Chain	Res	Type	Atoms	Z	Observed(°)	Ideal(°)
4	B	562	ADP	N3-C2-N1	-3.71	122.88	128.68
4	A	562	ADP	N3-C2-N1	-3.68	122.93	128.68
4	B	562	ADP	PA-O3A-PB	-3.50	120.83	132.83
4	A	562	ADP	PA-O3A-PB	-3.06	122.32	132.83
4	B	562	ADP	C4-C5-N7	-2.61	106.68	109.40
4	A	562	ADP	C4-C5-N7	-2.50	106.79	109.40
4	A	562	ADP	C3'-C2'-C1'	2.48	104.71	100.98



There are no chirality outliers.

All (1) torsion outliers are listed below:

Mol	Chain	Res	Type	Atoms
4	B	562	ADP	C4'-C5'-O5'-PA

There are no ring outliers.

1 monomer is involved in 1 short contact:

Mol	Chain	Res	Type	Clashes	Symm-Clashes
4	B	562	ADP	1	0

The following is a two-dimensional graphical depiction of Mogul quality analysis of bond lengths, bond angles, torsion angles, and ring geometry for all instances of the Ligand of Interest. In addition, ligands with molecular weight > 250 and outliers as shown on the validation Tables will also be included. For torsion angles, if less than 5% of the Mogul distribution of torsion angles is within 10 degrees of the torsion angle in question, then that torsion angle is considered an outlier. Any bond that is central to one or more torsion angles identified as an outlier by Mogul will be highlighted in the graph. For rings, the root-mean-square deviation (RMSD) between the ring in question and similar rings identified by Mogul is calculated over all ring torsion angles. If the average RMSD is greater than 60 degrees and the minimal RMSD between the ring in question and any Mogul-identified rings is also greater than 60 degrees, then that ring is considered an outlier. The outliers are highlighted in purple. The color gray indicates Mogul did not find sufficient equivalents in the CSD to analyse the geometry.

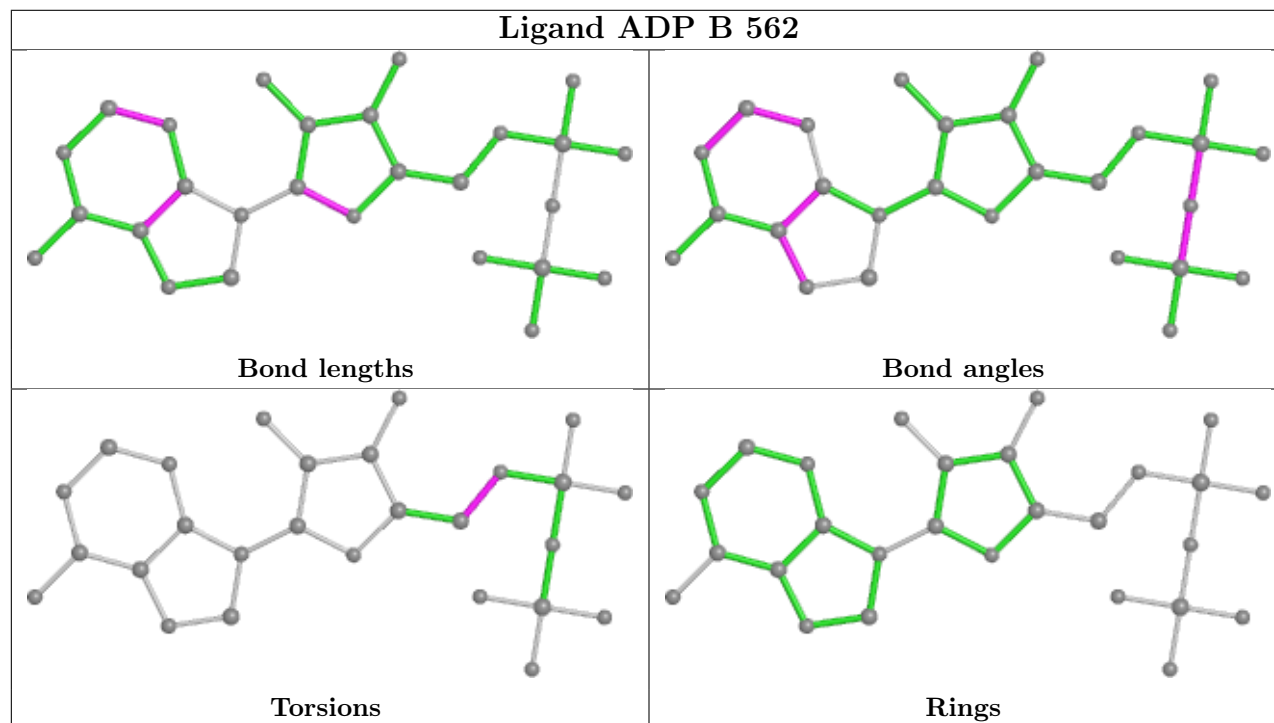

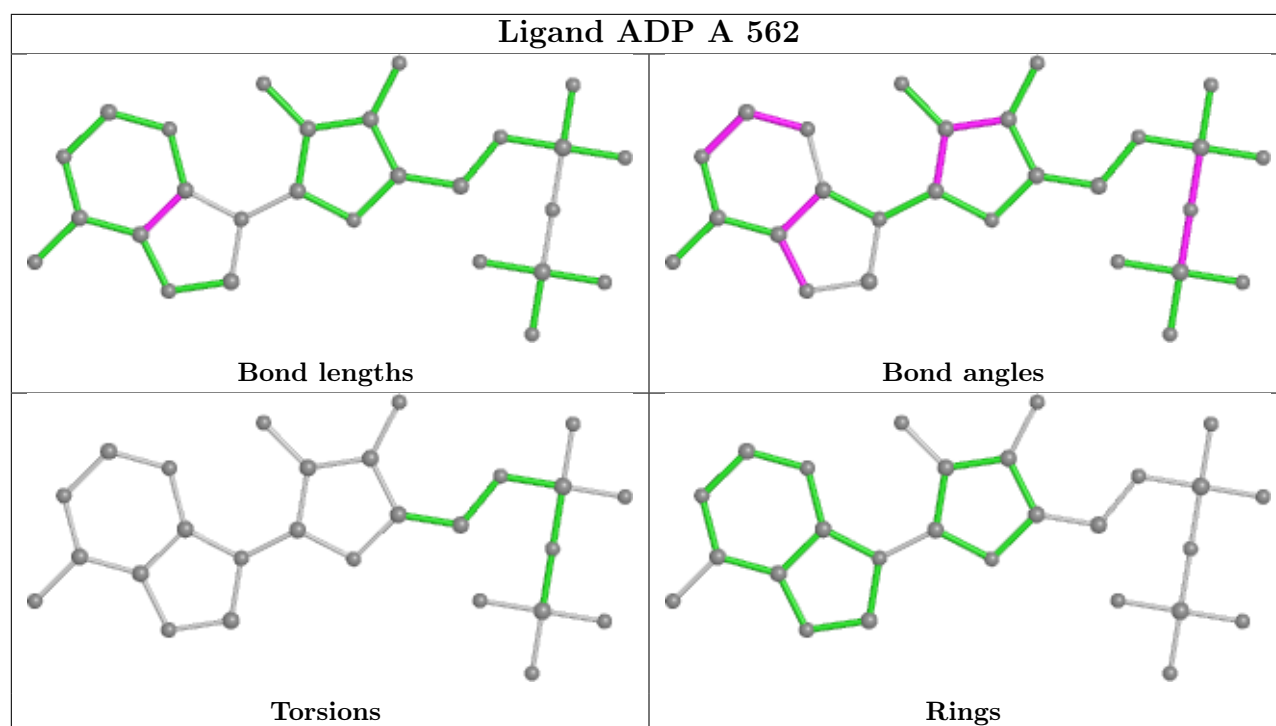

## 5.7 Other polymers [i](#)

There are no such residues in this entry.

## 5.8 Polymer linkage issues [i](#)

There are no chain breaks in this entry.

## 6 Fit of model and data [i](#)

### 6.1 Protein, DNA and RNA chains [i](#)

In the following table, the column labelled '#RSRZ > 2' contains the number (and percentage) of RSRZ outliers, followed by percent RSRZ outliers for the chain as percentile scores relative to all X-ray entries and entries of similar resolution. The OWAB column contains the minimum, median, 95<sup>th</sup> percentile and maximum values of the occupancy-weighted average B-factor per residue. The column labelled 'Q < 0.9' lists the number of (and percentage) of residues with an average occupancy less than 0.9.

Mol	Chain	Analysed	<RSRZ>	#RSRZ>2	OWAB(Å <sup>2</sup> )	Q<0.9
1	A	487/543 (89%)	-0.15	8 (1%) 72 57	117, 134, 142, 162	1 (0%)
1	B	461/543 (84%)	-0.08	10 (2%) 62 45	113, 133, 140, 149	0
All	All	948/1086 (87%)	-0.11	18 (1%) 66 50	113, 133, 141, 162	1 (0%)

All (18) RSRZ outliers are listed below:

Mol	Chain	Res	Type	RSRZ
1	A	365	GLU	4.6
1	A	341	ALA	4.5
1	B	384	ALA	3.9
1	B	101	ALA	3.5
1	B	466	THR	3.3
1	B	441	GLY	2.9
1	A	489	THR	2.9
1	B	414	ASP	2.7
1	B	403	GLN	2.7
1	B	117	PRO	2.3
1	B	418	PRO	2.2
1	A	474	ARG	2.2
1	B	200	GLU	2.2
1	A	488	SER	2.1
1	A	282	ASP	2.1
1	A	283	ASN	2.1
1	B	440	ASP	2.0
1	A	350	ALA	2.0

### 6.2 Non-standard residues in protein, DNA, RNA chains [i](#)

There are no non-standard protein/DNA/RNA residues in this entry.

### 6.3 Carbohydrates [i](#)

There are no monosaccharides in this entry.

### 6.4 Ligands [i](#)

In the following table, the Atoms column lists the number of modelled atoms in the group and the number defined in the chemical component dictionary. The B-factors column lists the minimum, median, 95<sup>th</sup> percentile and maximum values of B factors of atoms in the group. The column labelled 'Q< 0.9' lists the number of atoms with occupancy less than 0.9.

Mol	Type	Chain	Res	Atoms	RSCC	RSR	B-factors(Å <sup>2</sup> )	Q<0.9
3	BR	A	566	1/1	0.90	0.27	168,168,168,168	0
4	ADP	B	562	27/27	0.93	0.17	132,135,137,138	0
3	BR	A	568	1/1	0.94	0.36	153,153,153,153	0
2	MG	A	563	1/1	0.95	0.07	109,109,109,109	0
4	ADP	A	562	27/27	0.95	0.13	121,126,131,132	0
3	BR	A	567	1/1	0.95	0.18	115,115,115,115	0
3	BR	B	566	1/1	0.97	0.25	99,99,99,99	0
2	MG	B	564	1/1	0.97	0.19	110,110,110,110	0
3	BR	B	565	1/1	0.97	0.21	100,100,100,100	0
2	MG	A	564	1/1	0.98	0.44	122,122,122,122	0
2	MG	B	563	1/1	0.98	0.11	116,116,116,116	0

The following is a graphical depiction of the model fit to experimental electron density of all instances of the Ligand of Interest. In addition, ligands with molecular weight > 250 and outliers as shown on the geometry validation Tables will also be included. Each fit is shown from different orientation to approximate a three-dimensional view.

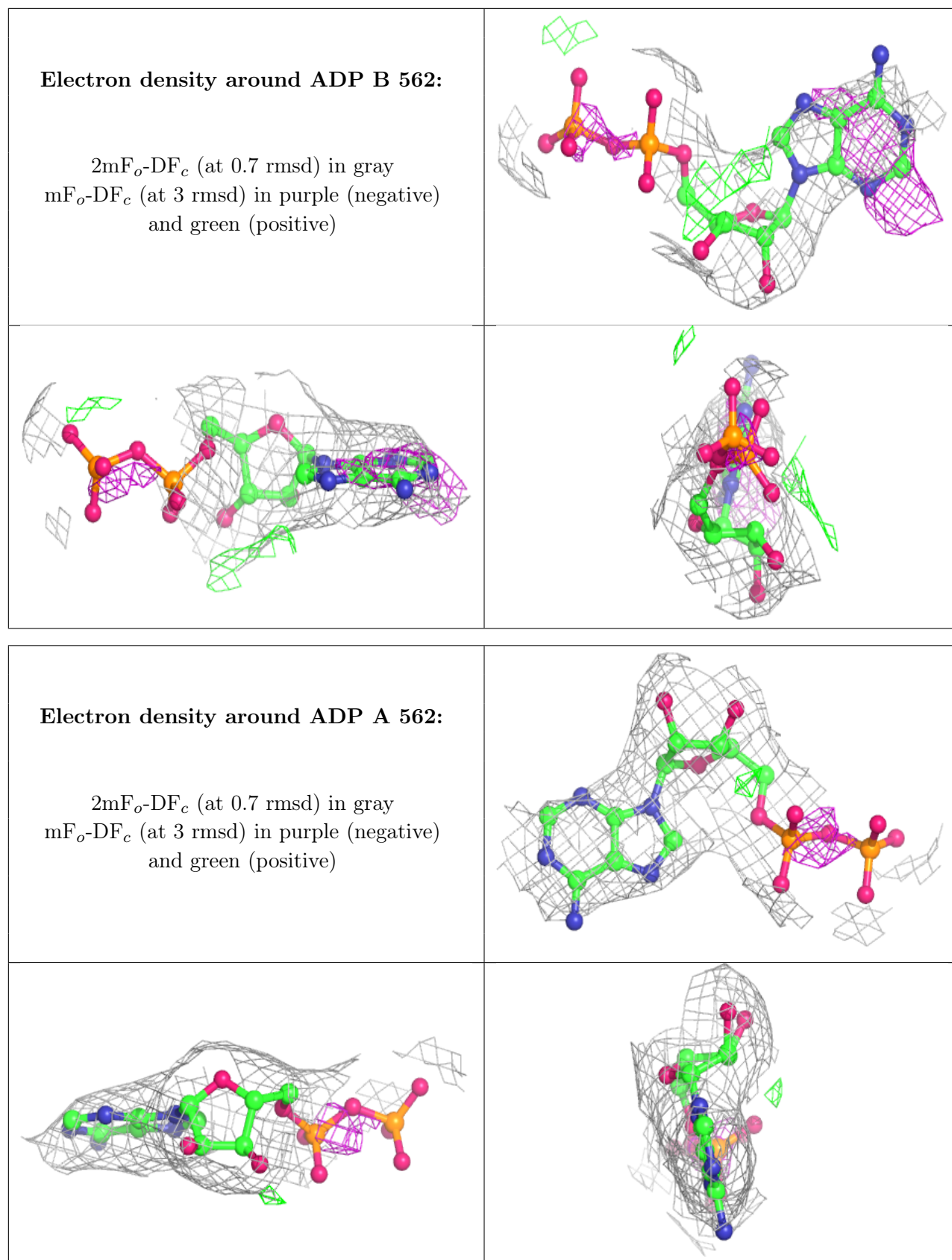

## 6.5 Other polymers [i](#)

There are no such residues in this entry.