



# Full wwPDB X-ray Structure Validation Report ⓘ

Nov 5, 2023 – 09:11 PM EST

PDB ID : 1S32  
Title : Molecular Recognition of the Nucleosomal 'Supergroove'  
Authors : Edayathumangalam, R.S.; Weyermann, P.; Gottesfeld, J.M.; Dervan, P.B.;  
Luger, K.  
Deposited on : 2004-01-12  
Resolution : 2.05 Å(reported)

This is a Full wwPDB X-ray Structure Validation Report for a publicly released PDB entry.

We welcome your comments at [validation@mail.wwpdb.org](mailto:validation@mail.wwpdb.org)

A user guide is available at

<https://www.wwpdb.org/validation/2017/XrayValidationReportHelp>

with specific help available everywhere you see the ⓘ symbol.

The types of validation reports are described at

<http://www.wwpdb.org/validation/2017/FAQs#types>.

---

The following versions of software and data (see [references ⓘ](#)) were used in the production of this report:

MolProbity : 4.02b-467  
Mogul : 1.8.5 (274361), CSD as541be (2020)  
Xtriage (Phenix) : 1.13  
EDS : 2.36  
Percentile statistics : 20191225.v01 (using entries in the PDB archive December 25th 2019)  
Refmac : 5.8.0158  
CCP4 : 7.0.044 (Gargrove)  
Ideal geometry (proteins) : Engh & Huber (2001)  
Ideal geometry (DNA, RNA) : Parkinson et al. (1996)  
Validation Pipeline (wwPDB-VP) : 2.36

# 1 Overall quality at a glance

The following experimental techniques were used to determine the structure:

*X-RAY DIFFRACTION*

The reported resolution of this entry is 2.05 Å.

Percentile scores (ranging between 0-100) for global validation metrics of the entry are shown in the following graphic. The table shows the number of entries on which the scores are based.

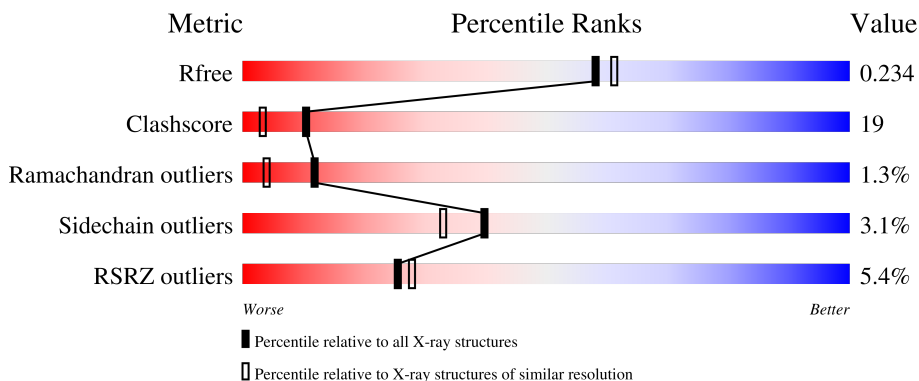

Metric	Whole archive (#Entries)	Similar resolution (#Entries, resolution range(Å))
$R_{free}$	130704	1692 (2.04-2.04)
Clashscore	141614	1773 (2.04-2.04)
Ramachandran outliers	138981	1752 (2.04-2.04)
Sidechain outliers	138945	1752 (2.04-2.04)
RSRZ outliers	127900	1672 (2.04-2.04)

The table below summarises the geometric issues observed across the polymeric chains and their fit to the electron density. The red, orange, yellow and green segments of the lower bar indicate the fraction of residues that contain outliers for  $\geq 3$ , 2, 1 and 0 types of geometric quality criteria respectively. A grey segment represents the fraction of residues that are not modelled. The numeric value for each fraction is indicated below the corresponding segment, with a dot representing fractions  $\leq 5\%$ . The upper red bar (where present) indicates the fraction of residues that have poor fit to the electron density. The numeric value is given above the bar.

Mol	Chain	Length	Quality of chain
1	I	146	 2% 60% 40%
1	J	146	 3% 49% 51%
2	A	135	 2% 52% 19% 27%
2	E	135	 4% 59% 14% 27%
3	B	102	 4% 62% 14% 21%

*Continued on next page...*

Continued from previous page...

Mol	Chain	Length	Quality of chain
3	F	102	
4	C	119	
4	G	119	
5	D	122	
5	H	122	

The following table lists non-polymeric compounds, carbohydrate monomers and non-standard residues in protein, DNA, RNA chains that are outliers for geometric or electron-density-fit criteria:

Mol	Type	Chain	Res	Chirality	Geometry	Clashes	Electron density
11	DIB	I	1611	-	-	X	X
11	DIB	I	1631	-	-	-	X
12	OGG	J	1700	-	X	X	-
7	IMT	I	1601	-	-	X	-
7	IMT	I	1603	-	-	X	-
7	IMT	I	1621	-	-	X	-
7	IMT	I	1623	-	-	X	-
8	PYB	I	1602	-	-	X	-
8	PYB	I	1604	-	-	X	-
8	PYB	I	1606	-	-	X	-
8	PYB	I	1607	-	-	X	-
8	PYB	I	1608	-	-	X	-
8	PYB	I	1622	-	-	X	-
8	PYB	I	1624	-	-	X	-
8	PYB	I	1626	-	-	X	-
8	PYB	I	1627	-	-	X	-
8	PYB	I	1628	-	-	X	-
8	PYB	I	1629	-	-	X	-
9	ABU	I	1605	-	X	X	-
9	ABU	I	1625	-	X	X	-

## 2 Entry composition [i](#)

There are 14 unique types of molecules in this entry. The entry contains 13437 atoms, of which 0 are hydrogens and 0 are deuteriums.

In the tables below, the ZeroOcc column contains the number of atoms modelled with zero occupancy, the AltConf column contains the number of residues with at least one atom in alternate conformation and the Trace column contains the number of residues modelled with at most 2 atoms.

- Molecule 1 is a DNA chain called palindromic alpha-satellite 146 bp DNA fragment.

Mol	Chain	Residues	Atoms					ZeroOcc	AltConf	Trace
			Total	C	N	O	P			
1	I	146	2990	1430	541	874	145	0	0	0
1	J	146	2990	1430	541	874	145	0	0	0

- Molecule 2 is a protein called Histone H3.

Mol	Chain	Residues	Atoms					ZeroOcc	AltConf	Trace
			Total	C	N	O	S			
2	A	98	816	514	157	141	4	0	1	0
2	E	99	867	547	170	146	4	0	5	0

- Molecule 3 is a protein called Histone H4.

Mol	Chain	Residues	Atoms					ZeroOcc	AltConf	Trace
			Total	C	N	O	S			
3	B	81	666	418	132	115	1	0	2	0
3	F	88	730	457	151	121	1	0	2	0

- Molecule 4 is a protein called Histone H2A.

Mol	Chain	Residues	Atoms				ZeroOcc	AltConf	Trace
			Total	C	N	O			
4	C	107	834	525	165	144	0	1	0
4	G	107	828	522	162	144	0	0	0

- Molecule 5 is a protein called Histone H2B.

Mol	Chain	Residues	Atoms					ZeroOcc	AltConf	Trace
5	D	101	Total	C	N	O	S	0	3	0
			828	520	154	152	2			
5	H	98	Total	C	N	O	S	0	2	0
			792	496	148	146	2			

- Molecule 6 is MANGANESE (II) ION (three-letter code: MN) (formula: Mn).

Mol	Chain	Residues	Atoms		ZeroOcc	AltConf
6	I	7	Total	Mn	0	0
			7	7		
6	J	6	Total	Mn	0	0
			6	6		
6	E	1	Total	Mn	0	0
			1	1		

- Molecule 7 is 4-AMINO-(1-METHYLIMIDAZOLE)-2-CARBOXYLIC ACID (three-letter code: IMT) (formula: C<sub>5</sub>H<sub>7</sub>N<sub>3</sub>O<sub>2</sub>).

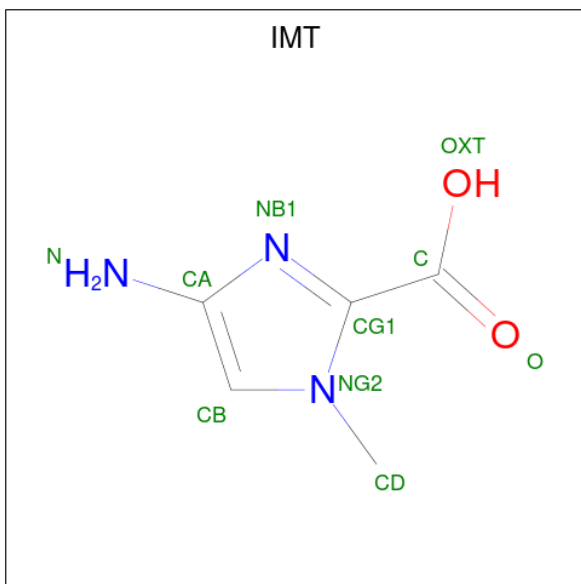

Mol	Chain	Residues	Atoms				ZeroOcc	AltConf
7	I	1	Total	C	N	O	0	0
			8	5	2	1		
7	I	1	Total	C	N	O	0	0
			9	5	3	1		
7	I	1	Total	C	N	O	0	0
			8	5	2	1		
7	I	1	Total	C	N	O	0	0
			9	5	3	1		

- Molecule 8 is 4-AMINO-(1-METHYLPYRROLE)-2-CARBOXYLIC ACID (three-letter code: PYB) (formula: C<sub>6</sub>H<sub>8</sub>N<sub>2</sub>O<sub>2</sub>).

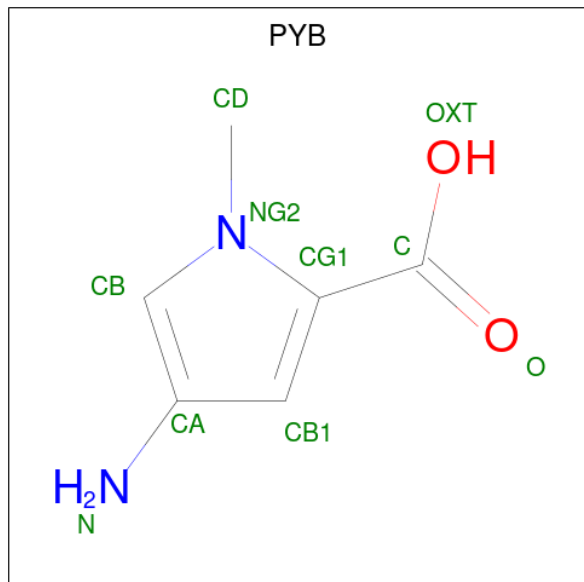

Mol	Chain	Residues	Atoms				ZeroOcc	AltConf
8	I	1	Total	C	N	O	0	0
			9	6	2	1		
8	I	1	Total	C	N	O	0	0
			9	6	2	1		
8	I	1	Total	C	N	O	0	0
			9	6	2	1		
8	I	1	Total	C	N	O	0	0
			9	6	2	1		
8	I	1	Total	C	N	O	0	0
			9	6	2	1		
8	I	1	Total	C	N	O	0	0
			9	6	2	1		
8	I	1	Total	C	N	O	0	0
			9	6	2	1		
8	I	1	Total	C	N	O	0	0
			9	6	2	1		
8	I	1	Total	C	N	O	0	0
			9	6	2	1		

- Molecule 9 is GAMMA-AMINO-BUTANOIC ACID (three-letter code: ABU) (formula:  $C_4H_9NO_2$ ).

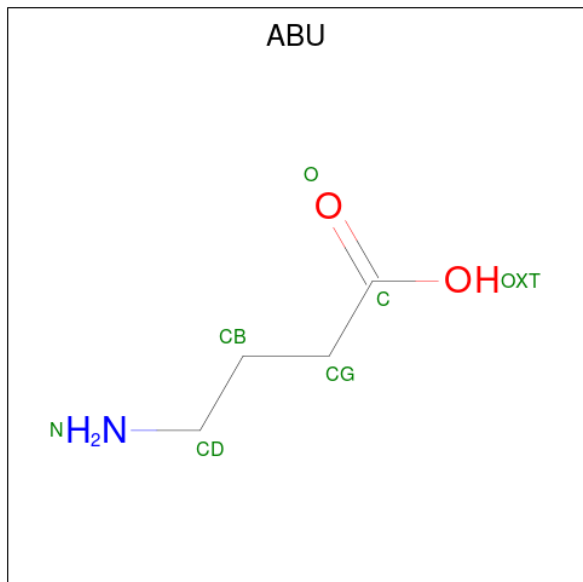

Mol	Chain	Residues	Atoms				ZeroOcc	AltConf
			Total	C	N	O		
9	I	1	6	4	1	1	0	0
9	I	1	6	4	1	1	0	0

- Molecule 10 is BETA-ALANINE (three-letter code: BAL) (formula:  $C_3H_7NO_2$ ).

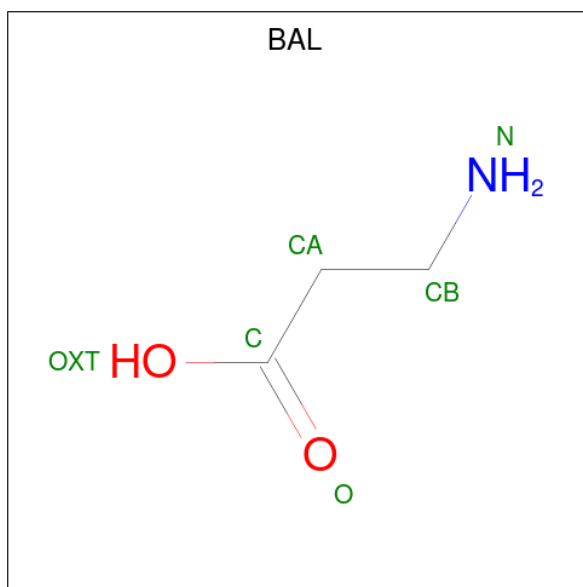

Mol	Chain	Residues	Atoms				ZeroOcc	AltConf
10	I	1	Total	C	N	O	0	0
			5	3	1	1		
10	I	1	Total	C	N	O	0	0
			5	3	1	1		

- Molecule 11 is 3-AMINO-(DIMETHYLPROPYLAMINE) (three-letter code: DIB) (formula:  $C_5H_{14}N_2$ ).

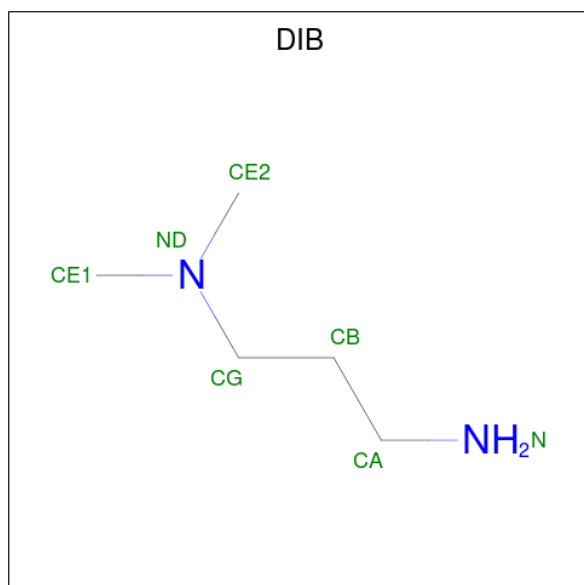

Mol	Chain	Residues	Atoms			ZeroOcc	AltConf
11	I	1	Total	C	N	0	0
			7	5	2		
11	I	1	Total	C	N	0	0
			7	5	2		

- Molecule 12 is 2-(2-CARBAMOYLMETHOXY-ETHOXY)-ACETAMIDE (three-letter code: OGG) (formula:  $C_6H_{12}N_2O_4$ ).



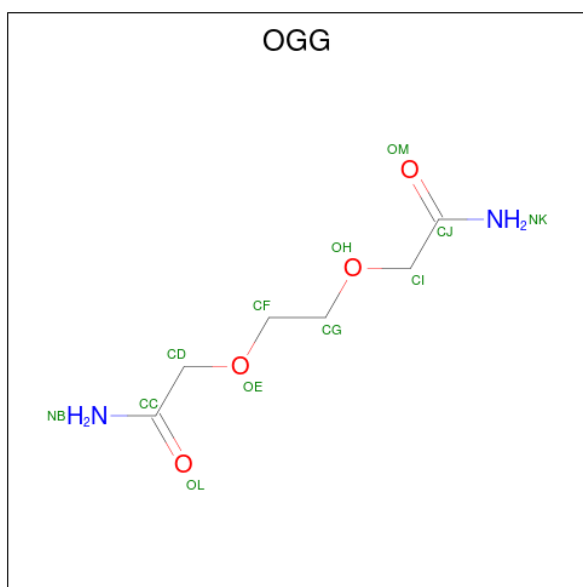

Mol	Chain	Residues	Atoms				ZeroOcc	AltConf
			Total	C	N	O		
12	J	1	12	6	2	4	0	0

- Molecule 13 is CHLORIDE ION (three-letter code: CL) (formula: Cl).

Mol	Chain	Residues	Atoms		ZeroOcc	AltConf
			Total	Cl		
13	A	1	1	1	0	0
13	D	1	1	1	0	0
13	E	1	1	1	0	0
13	G	1	1	1	0	0

- Molecule 14 is water.

Mol	Chain	Residues	Atoms		ZeroOcc	AltConf
			Total	O		
14	I	145	145	145	1	0
14	J	151	151	151	0	0
14	A	77	77	77	0	0
14	B	53	53	53	0	0

*Continued on next page...*

*Continued from previous page...*

Mol	Chain	Residues	Atoms		ZeroOcc	AltConf
14	C	109	Total 109	O 109	0	0
14	D	62	Total 62	O 62	0	0
14	E	97	Total 97	O 97	0	0
14	F	85	Total 85	O 85	0	0
14	G	80	Total 80	O 80	0	0
14	H	29	Total 29	O 29	0	0

### 3 Residue-property plots

These plots are drawn for all protein, RNA, DNA and oligosaccharide chains in the entry. The first graphic for a chain summarises the proportions of the various outlier classes displayed in the second graphic. The second graphic shows the sequence view annotated by issues in geometry and electron density. Residues are color-coded according to the number of geometric quality criteria for which they contain at least one outlier: green = 0, yellow = 1, orange = 2 and red = 3 or more. A red dot above a residue indicates a poor fit to the electron density ( $RSRZ > 2$ ). Stretches of 2 or more consecutive residues without any outlier are shown as a green connector. Residues present in the sample, but not in the model, are shown in grey.

- Molecule 1: palindromic alpha-satellite 146 bp DNA fragment

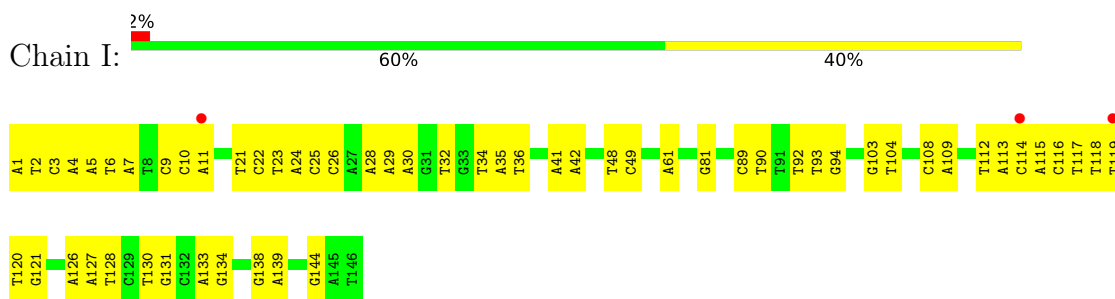

- Molecule 1: palindromic alpha-satellite 146 bp DNA fragment



- Molecule 2: Histone H3

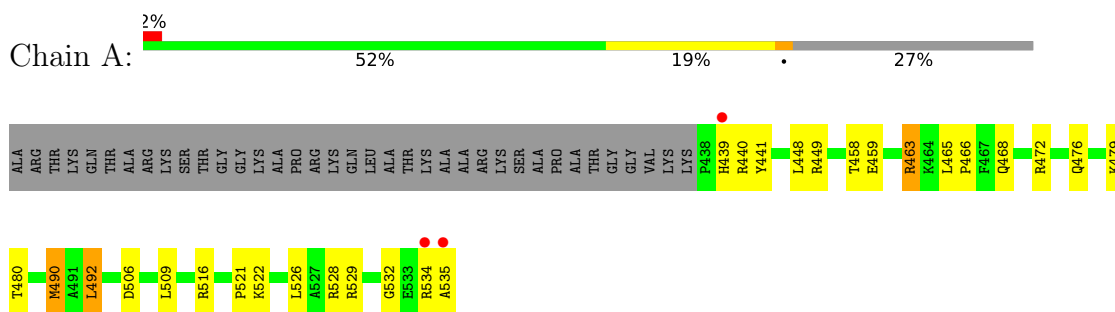

- Molecule 2: Histone H3

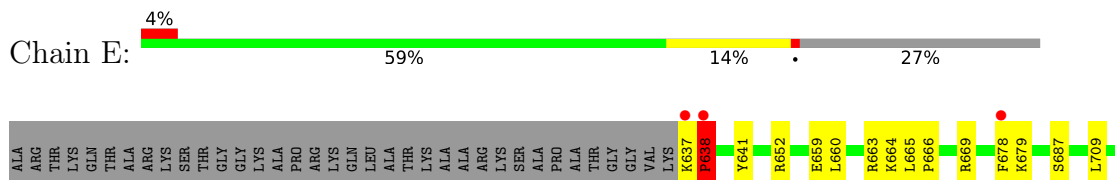

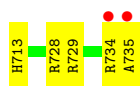

- Molecule 3: Histone H4

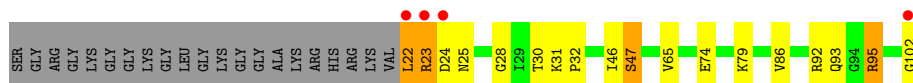

- Molecule 3: Histone H4



- Molecule 4: Histone H2A

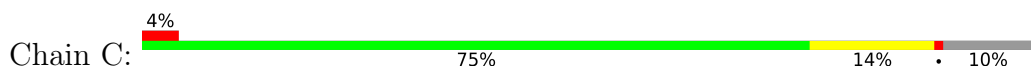

- Molecule 4: Histone H2A

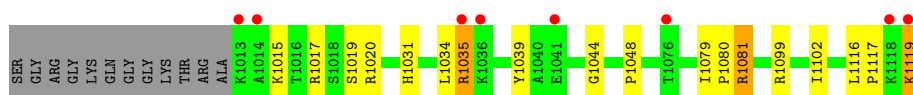
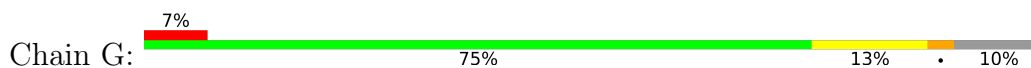

- Molecule 5: Histone H2B

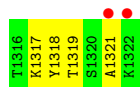
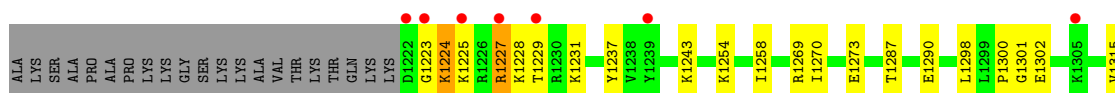

- Molecule 5: Histone H2B



ALA	
LYS	
SER	
ALA	
PRO	
ALA	
PRO	
LYS	
LYS	
GLY	
SER	
LYS	
LYS	
ALA	
VAL	
THR	
LYS	
THR	
GLN	
LYS	
LYS	
ASP	
GLY	
LYS	
K1425	
R1426	
R1427	
K1428	
T1429	
R1430	
S1433	
Y1439	
K1443	
Q1444	
V1445	
H1446	
I1458	
G1501	
K1505	
K1517	
Y1518	
T1519	
S1520	
A1521	
K1522	

## 4 Data and refinement statistics

Property	Value	Source
Space group	P 21 21 21	Depositor
Cell constants a, b, c, $\alpha$ , $\beta$ , $\gamma$	105.35Å 109.72Å 181.83Å 90.00° 90.00° 90.00°	Depositor
Resolution (Å)	100.00 – 2.05 93.94 – 2.05	Depositor EDS
% Data completeness (in resolution range)	90.7 (100.00-2.05) 91.2 (93.94-2.05)	Depositor EDS
$R_{merge}$	0.08	Depositor
$R_{sym}$	(Not available)	Depositor
$\langle I/\sigma(I) \rangle$ <sup>1</sup>	1.89 (at 2.05Å)	Xtrriage
Refinement program	CNS 1.0	Depositor
R, $R_{free}$	0.219 , 0.243 0.212 , 0.234	Depositor DCC
$R_{free}$ test set	6276 reflections (5.04%)	wwPDB-VP
Wilson B-factor (Å <sup>2</sup> )	44.1	Xtrriage
Anisotropy	0.242	Xtrriage
Bulk solvent $k_{sol}$ (e/Å <sup>3</sup> ), $B_{sol}$ (Å <sup>2</sup> )	0.29 , 54.2	EDS
L-test for twinning <sup>2</sup>	$\langle  L  \rangle = 0.48$ , $\langle L^2 \rangle = 0.32$	Xtrriage
Estimated twinning fraction	0.016 for k,h,-l	Xtrriage
$F_o, F_c$ correlation	0.95	EDS
Total number of atoms	13437	wwPDB-VP
Average B, all atoms (Å <sup>2</sup> )	73.0	wwPDB-VP

Xtrriage's analysis on translational NCS is as follows: *The largest off-origin peak in the Patterson function is 2.86% of the height of the origin peak. No significant pseudotranslation is detected.*

<sup>1</sup>Intensities estimated from amplitudes.

<sup>2</sup>Theoretical values of  $\langle |L| \rangle$ ,  $\langle L^2 \rangle$  for acentric reflections are 0.5, 0.333 respectively for untwinned datasets, and 0.375, 0.2 for perfectly twinned datasets.

## 5 Model quality

### 5.1 Standard geometry

Bond lengths and bond angles in the following residue types are not validated in this section: IMT, PYB, BAL, ABU, DIB, CL, MN, OGG

The Z score for a bond length (or angle) is the number of standard deviations the observed value is removed from the expected value. A bond length (or angle) with  $|Z| > 5$  is considered an outlier worth inspection. RMSZ is the root-mean-square of all Z scores of the bond lengths (or angles).

Mol	Chain	Bond lengths		Bond angles	
		RMSZ	# Z  >5	RMSZ	# Z  >5
1	I	0.26	0/3354	0.68	0/5175
1	J	0.27	0/3354	0.68	0/5175
2	A	0.38	0/828	0.57	0/1109
2	E	0.51	0/880	0.64	1/1176 (0.1%)
3	B	0.37	0/673	0.61	0/899
3	F	0.42	0/738	0.71	1/983 (0.1%)
4	C	0.44	0/844	0.60	1/1138 (0.1%)
4	G	0.33	0/838	0.51	0/1128
5	D	0.41	0/840	0.62	0/1124
5	H	0.33	0/804	0.53	0/1077
All	All	0.34	0/13153	0.65	3/18984 (0.0%)

There are no bond length outliers.

All (3) bond angle outliers are listed below:

Mol	Chain	Res	Type	Atoms	Z	Observed(°)	Ideal(°)
3	F	218	HIS	N-CA-C	5.79	126.63	111.00
2	E	735	ALA	N-CA-C	5.11	124.78	111.00
4	C	813	LYS	N-CA-C	5.06	124.67	111.00

There are no chirality outliers.

There are no planarity outliers.

### 5.2 Too-close contacts

In the following table, the Non-H and H(model) columns list the number of non-hydrogen atoms and hydrogen atoms in the chain respectively. The H(added) column lists the number of hydrogen atoms added and optimized by MolProbity. The Clashes column lists the number of clashes within the asymmetric unit, whereas Symm-Clashes lists symmetry-related clashes.

Mol	Chain	Non-H	H(model)	H(added)	Clashes	Symm-Clashes
1	I	2990	0	1651	99	0
1	J	2990	0	1651	106	0
2	A	816	0	854	34	0
2	E	867	0	910	23	0
3	B	666	0	706	21	0
3	F	730	0	784	25	0
4	C	834	0	894	30	0
4	G	828	0	890	27	0
5	D	828	0	862	34	0
5	H	792	0	822	19	0
6	E	1	0	0	0	0
6	I	7	0	0	0	0
6	J	6	0	0	0	0
7	I	34	0	18	19	0
8	I	108	0	72	55	0
9	I	12	0	0	15	0
10	I	10	0	10	0	0
11	I	14	0	26	16	0
12	J	12	0	10	10	0
13	A	1	0	0	1	0
13	D	1	0	0	0	0
13	E	1	0	0	0	0
13	G	1	0	0	1	0
14	A	77	0	0	8	0
14	B	53	0	0	3	0
14	C	109	0	0	7	0
14	D	62	0	0	6	0
14	E	97	0	0	5	0
14	F	85	0	0	3	0
14	G	80	0	0	2	0
14	H	29	0	0	0	0
14	I	145	0	0	9	0
14	J	151	0	0	5	0
All	All	13437	0	10160	421	0

The all-atom clashscore is defined as the number of clashes found per 1000 atoms (including hydrogen atoms). The all-atom clashscore for this structure is 19.

All (421) close contacts within the same asymmetric unit are listed below, sorted by their clash magnitude.

Atom-1	Atom-2	Interatomic distance (Å)	Clash overlap (Å)
12:J:1700:OGG:OH	12:J:1700:OGG:CG	1.65	1.44

*Continued on next page...*



*Continued from previous page...*

Atom-1	Atom-2	Interatomic distance (Å)	Clash overlap (Å)
12:J:1700:OGG:OH	12:J:1700:OGG:CI	1.70	1.39
12:J:1700:OGG:CD	12:J:1700:OGG:OE	1.80	1.29
1:I:133:DA:H2''	1:I:134:DG:H5''	1.36	1.07
1:J:261:DA:H2''	1:J:262:DC:H5''	1.38	1.05
3:B:65:VAL:HA	3:B:93[B]:GLN:HE22	1.21	1.00
1:I:114:DC:O2	8:I:1626:PYB:HB1	1.64	0.97
5:D:1254:LYS:HD3	14:D:3890:HOH:O	1.62	0.97
4:C:820[B]:ARG:HG2	4:C:820[B]:ARG:HH11	1.30	0.96
7:I:1603:IMT:O	8:I:1604:PYB:HB	1.66	0.95
2:E:652[B]:ARG:NH1	14:E:3866:HOH:O	1.97	0.95
2:E:637:LYS:N	2:E:638:PRO:HD2	1.82	0.94
2:E:660:LEU:HD12	2:E:664[A]:LYS:HE2	1.50	0.93
1:I:30:DA:O4'	11:I:1611:DIB:HB1	1.70	0.91
1:I:119:DT:H2''	1:I:120:DT:OP2	1.72	0.88
1:I:3:DC:H5	1:J:290:DG:H1	1.20	0.87
9:I:1625:ABU:CB	12:J:1700:OGG:OM	2.21	0.85
4:G:1117:PRO:HG2	14:G:3871:HOH:O	1.75	0.85
1:J:233:DG:H2''	1:J:234:DC:OP2	1.78	0.84
1:J:197:DA:H2''	1:J:198:DT:H5'	1.58	0.84
1:J:261:DA:C2'	1:J:262:DC:H5''	2.07	0.84
1:J:246:DG:H2''	1:J:247:DC:C5	2.13	0.84
3:B:65:VAL:HA	3:B:93[B]:GLN:NE2	1.93	0.83
1:I:114:DC:H1'	8:I:1626:PYB:CB1	2.09	0.83
2:E:637:LYS:N	2:E:638:PRO:CD	2.42	0.83
1:I:28:DA:H5''	5:D:1227:ARG:NH2	1.94	0.82
4:C:833:LEU:HD23	4:C:836:LYS:HD3	1.59	0.82
1:J:261:DA:H2''	1:J:262:DC:C5'	2.09	0.81
7:I:1623:IMT:O	8:I:1624:PYB:HB	1.80	0.80
4:C:817:ARG:HH12	4:C:831:HIS:HD2	1.31	0.79
1:I:103:DG:OP1	5:D:1229:THR:HG22	1.82	0.79
4:C:890:ASP:OD2	14:C:3436:HOH:O	2.00	0.79
1:J:248:DA:H2''	1:J:249:DG:C8	2.16	0.79
3:F:216:LYS:NZ	3:F:219:ARG:HH22	1.79	0.79
1:I:21:DT:H2''	1:I:22:DC:H5''	1.64	0.77
1:I:93:DT:H6	14:I:3889:HOH:O	1.65	0.77
1:I:114:DC:H1'	8:I:1626:PYB:HB1	1.67	0.77
9:I:1605:ABU:CB	12:J:1700:OGG:CD	2.64	0.76
1:J:272:DA:H4'	1:J:273:DA:OP1	1.84	0.76
3:B:102:GLY:OXT	14:B:3862:HOH:O	2.04	0.76
11:I:1611:DIB:HA2	11:I:1611:DIB:CE1	2.17	0.74
4:G:1017:ARG:HH12	4:G:1031:HIS:CD2	2.05	0.74

*Continued on next page...*

*Continued from previous page...*

Atom-1	Atom-2	Interatomic distance (Å)	Clash overlap (Å)
1:I:2:DT:H2''	1:I:3:DC:H5'	1.71	0.73
8:I:1606:PYB:HB1	1:J:260:DC:O2	1.87	0.73
1:I:133:DA:C2'	1:I:134:DG:H5''	2.18	0.73
4:C:892:GLU:HB2	14:C:3433:HOH:O	1.87	0.73
1:I:21:DT:H2''	1:I:22:DC:C5'	2.18	0.73
1:I:32:DT:O4'	7:I:1601:IMT:CA	2.37	0.72
5:D:1223:GLY:O	5:D:1224:LYS:HB2	1.88	0.72
3:F:216:LYS:HZ1	3:F:219:ARG:HH22	1.38	0.72
1:I:93:DT:H2''	1:I:94:DG:H5'	1.71	0.71
11:I:1611:DIB:HA2	11:I:1611:DIB:HE12	1.72	0.71
1:I:22:DC:N4	1:J:271:DG:H1	1.87	0.71
9:I:1605:ABU:C	9:I:1605:ABU:N	2.42	0.71
1:I:1:DA:H2''	1:I:2:DT:H72	1.72	0.71
3:B:65:VAL:CA	3:B:93[B]:GLN:HE22	1.99	0.71
2:E:729[B]:ARG:HD3	2:E:729[B]:ARG:C	2.11	0.71
8:I:1608:PYB:O	8:I:1609:PYB:HB	1.90	0.70
4:C:812:ALA:O	4:C:813:LYS:HD2	1.92	0.70
1:I:30:DA:C1'	11:I:1611:DIB:HB1	2.21	0.70
1:I:144:DG:H1	1:J:149:DC:H42	1.39	0.70
11:I:1631:DIB:HB1	1:J:176:DA:O4'	1.92	0.70
4:C:820[B]:ARG:HH11	4:C:820[B]:ARG:CG	2.02	0.69
1:I:3:DC:H5	1:J:290:DG:N1	1.90	0.69
3:B:65:VAL:HG22	3:B:93[B]:GLN:OE1	1.93	0.69
3:F:216:LYS:NZ	3:F:219:ARG:NH2	2.40	0.69
1:J:193:DC:H2''	1:J:194:DT:H71	1.74	0.69
1:J:250:DT:H2'	14:J:3648:HOH:O	1.93	0.69
1:I:93:DT:H2''	1:I:94:DG:C5'	2.23	0.68
7:I:1623:IMT:O	8:I:1624:PYB:CB	2.40	0.68
1:I:103:DG:H5''	5:D:1228:LYS:HA	1.75	0.68
3:F:231:LYS:HG2	3:F:235[B]:ARG:HH11	1.58	0.68
8:I:1606:PYB:O	8:I:1607:PYB:HB	1.94	0.67
2:A:439:HIS:ND1	14:A:3543:HOH:O	2.28	0.67
2:A:509:LEU:HD22	14:A:3858:HOH:O	1.93	0.67
4:C:815:LYS:HD3	14:C:3699:HOH:O	1.95	0.67
9:I:1625:ABU:CD	12:J:1700:OGG:CJ	2.69	0.66
8:I:1628:PYB:O	8:I:1629:PYB:HB	1.93	0.66
2:A:534:ARG:HD3	14:A:3861:HOH:O	1.95	0.66
11:I:1631:DIB:HE12	11:I:1631:DIB:HA2	1.75	0.66
4:C:820[A]:ARG:HG3	5:D:1321:ALA:HB3	1.78	0.66
4:C:813:LYS:O	4:C:813:LYS:HD3	1.96	0.65
1:J:175:DA:H2''	1:J:176:DA:C8	2.31	0.65

*Continued on next page...*

*Continued from previous page...*

Atom-1	Atom-2	Interatomic distance (Å)	Clash overlap (Å)
5:D:1273:GLU:HG3	5:D:1298[A]:LEU:HD11	1.77	0.65
8:I:1607:PYB:O	8:I:1608:PYB:HB	1.95	0.65
8:I:1624:PYB:HD1	8:I:1624:PYB:O	1.96	0.64
8:I:1604:PYB:HD1	8:I:1604:PYB:O	1.97	0.64
11:I:1631:DIB:HB1	1:J:176:DA:C1'	2.28	0.64
2:A:529:ARG:HD2	2:A:535:ALA:HB2	1.80	0.64
1:I:22:DC:H2''	1:I:23:DT:OP2	1.97	0.64
2:E:663:ARG:NE	14:E:3823:HOH:O	2.31	0.64
8:I:1627:PYB:O	8:I:1628:PYB:HB	1.98	0.64
1:J:237:DT:H4'	2:A:463:ARG:CZ	2.28	0.64
4:C:892:GLU:HB2	14:C:3436:HOH:O	1.97	0.64
5:D:1227:ARG:O	5:D:1227:ARG:HD3	1.98	0.64
1:I:5:DA:H2''	1:I:6:DT:H5'	1.80	0.64
7:I:1601:IMT:O	8:I:1602:PYB:HB	1.97	0.64
9:I:1625:ABU:C	9:I:1625:ABU:N	2.47	0.63
1:J:257:DA:H2''	1:J:258:DT:O5'	1.98	0.63
5:D:1317:LYS:HE3	14:D:3697:HOH:O	1.98	0.63
4:G:1035:ARG:NH1	4:G:1035:ARG:HG2	2.13	0.62
7:I:1603:IMT:O	8:I:1604:PYB:CB	2.29	0.62
1:J:249:DG:H5''	5:H:1428:LYS:H	1.64	0.62
8:I:1626:PYB:O	8:I:1627:PYB:HB	2.00	0.62
2:A:532:GLY:HA2	2:A:535:ALA:HB3	1.80	0.62
5:H:1426:ARG:HH11	5:H:1426:ARG:CG	2.13	0.62
1:I:25:DC:H1'	1:I:26:DC:H5'	1.80	0.62
4:G:1119:LYS:HA	4:G:1119:LYS:HE2	1.81	0.61
1:J:174:DA:H2''	1:J:175:DA:C5'	2.31	0.61
1:J:199:DC:H5''	3:F:217:ARG:NH2	2.16	0.61
8:I:1604:PYB:C	9:I:1605:ABU:OXT	2.48	0.61
1:I:3:DC:H2'	1:I:3:DC:O2	1.99	0.61
7:I:1621:IMT:O	8:I:1622:PYB:HB	2.00	0.61
7:I:1603:IMT:O	7:I:1603:IMT:HD1	2.01	0.60
14:A:3594:HOH:O	3:B:24:ASP:HB2	2.00	0.60
2:E:678[B]:PHE:CE1	3:F:267:ARG:HG3	2.36	0.60
1:J:147:DA:H2'	1:J:148:DT:H72	1.82	0.60
1:I:35:DA:H4'	8:I:1604:PYB:CB	2.30	0.60
1:I:119:DT:H4'	1:I:120:DT:H5'	1.82	0.60
2:E:729[B]:ARG:HD3	2:E:729[B]:ARG:O	2.02	0.60
1:I:5:DA:H2''	1:I:6:DT:C5'	2.32	0.60
9:I:1605:ABU:N	9:I:1605:ABU:OXT	2.35	0.60
3:B:31:LYS:HB3	3:B:32:PRO:HD3	1.84	0.60
4:C:892:GLU:HB3	5:D:1300:PRO:HG2	1.82	0.59

*Continued on next page...*

*Continued from previous page...*

Atom-1	Atom-2	Interatomic distance (Å)	Clash overlap (Å)
7:I:1621:IMT:HD2	8:I:1629:PYB:HD2	1.85	0.59
4:C:914:VAL:HG11	14:E:3441:HOH:O	2.03	0.59
4:G:1031:HIS:HE1	4:G:1035:ARG:HH21	1.47	0.59
1:I:29:DA:H2''	1:I:30:DA:C8	2.37	0.59
2:A:490[A]:MET:HA	2:A:490[A]:MET:CE	2.32	0.59
8:I:1608:PYB:O	8:I:1609:PYB:CB	2.47	0.59
1:J:151:DA:H2''	1:J:152:DT:C5'	2.32	0.59
5:D:1273:GLU:HG3	5:D:1298[A]:LEU:CG	2.32	0.59
1:J:197:DA:C2'	1:J:198:DT:H5'	2.30	0.59
1:J:241:DA:H4'	14:J:3668:HOH:O	2.02	0.59
4:C:892:GLU:N	14:C:3436:HOH:O	2.36	0.59
5:H:1426:ARG:NH1	5:H:1426:ARG:HG2	2.18	0.59
8:I:1628:PYB:O	8:I:1629:PYB:CB	2.50	0.58
1:J:249:DG:H4'	5:H:1426:ARG:HB3	1.85	0.58
1:I:28:DA:H5''	5:D:1227:ARG:HH21	1.68	0.58
1:I:119:DT:C4'	1:I:120:DT:H5'	2.33	0.58
2:A:490[A]:MET:HA	2:A:490[A]:MET:HE2	1.84	0.58
3:B:22:LEU:O	3:B:23:ARG:HB2	2.04	0.58
1:J:199:DC:H5''	3:F:217:ARG:HH22	1.67	0.58
1:J:233:DG:H1'	1:J:234:DC:H5'	1.86	0.57
1:I:130:DT:H2''	1:I:131:DG:N7	2.20	0.57
1:J:237:DT:OP1	2:A:466:PRO:HG3	2.04	0.57
4:G:1035:ARG:HG2	4:G:1035:ARG:HH11	1.68	0.57
4:G:1031:HIS:HE1	4:G:1035:ARG:NH2	2.02	0.57
1:I:21:DT:C2'	1:I:22:DC:H5''	2.33	0.57
8:I:1607:PYB:O	8:I:1608:PYB:CB	2.51	0.57
1:I:89:DC:H2''	1:I:90:DT:H71	1.87	0.57
8:I:1627:PYB:O	8:I:1627:PYB:HD1	2.05	0.57
1:I:5:DA:H1'	1:I:6:DT:H5''	1.87	0.56
3:F:216:LYS:CE	3:F:219:ARG:NH2	2.69	0.56
2:A:463:ARG:NH1	2:A:463:ARG:HG2	2.20	0.56
1:I:5:DA:H5''	14:I:3838:HOH:O	2.05	0.56
5:H:1426:ARG:HH11	5:H:1426:ARG:HG2	1.71	0.56
1:J:273:DA:H2''	1:J:274:DT:OP2	2.05	0.56
14:A:3868:HOH:O	2:E:709:LEU:HD22	2.05	0.56
4:G:1020:ARG:CZ	5:H:1522:LYS:O	2.53	0.56
1:J:151:DA:H2''	1:J:152:DT:H5'	1.86	0.56
2:A:463:ARG:HG2	2:A:463:ARG:HH11	1.71	0.56
7:I:1601:IMT:O	8:I:1602:PYB:CB	2.52	0.55
8:I:1606:PYB:O	8:I:1607:PYB:CB	2.50	0.55
1:J:173:DA:H2''	1:J:174:DA:C8	2.42	0.55

*Continued on next page...*

*Continued from previous page...*

Atom-1	Atom-2	Interatomic distance (Å)	Clash overlap (Å)
1:I:117:DT:H4'	8:I:1629:PYB:CB	2.36	0.55
8:I:1607:PYB:O	8:I:1607:PYB:HD1	2.06	0.55
3:F:231:LYS:HB3	3:F:232:PRO:HD3	1.88	0.55
1:I:28:DA:H2''	1:I:29:DA:H5'	1.87	0.55
3:F:223:ARG:HD3	14:F:3588:HOH:O	2.06	0.55
3:F:231:LYS:O	3:F:235[A]:ARG:HG2	2.06	0.55
8:I:1608:PYB:O	8:I:1608:PYB:HD1	2.07	0.55
1:J:178:DT:H2''	1:J:179:DG:C8	2.42	0.55
1:I:119:DT:C2'	1:I:120:DT:OP2	2.50	0.55
2:A:516:ARG:NH2	2:A:522:LYS:HE3	2.22	0.55
1:I:10:DC:H2''	1:I:11:DA:C8	2.42	0.55
7:I:1623:IMT:O	7:I:1623:IMT:HD1	2.06	0.55
1:I:30:DA:C4'	11:I:1611:DIB:HB1	2.36	0.54
2:A:463:ARG:O	2:A:466:PRO:HD2	2.07	0.54
1:I:115:DA:H5'	8:I:1626:PYB:C	2.38	0.54
12:J:1700:OGG:CG	12:J:1700:OGG:CI	2.85	0.54
1:I:23:DT:OP2	1:I:23:DT:H2'	2.07	0.54
1:J:193:DC:H2''	1:J:194:DT:C7	2.37	0.54
8:I:1604:PYB:HD1	14:I:3243:HOH:O	2.08	0.54
7:I:1621:IMT:O	7:I:1621:IMT:HD1	2.08	0.54
1:J:264:DT:H2''	1:J:265:DT:C7	2.38	0.54
2:A:458:THR:HG21	4:G:1081:ARG:HG2	1.90	0.54
1:I:4:DA:H5''	14:I:3799:HOH:O	2.08	0.54
7:I:1601:IMT:O	7:I:1601:IMT:HD1	2.08	0.54
3:B:92:ARG:NH2	5:D:1298[A]:LEU:HD23	2.23	0.54
8:I:1628:PYB:O	8:I:1628:PYB:HD1	2.08	0.54
1:J:233:DG:H1'	1:J:234:DC:C5'	2.37	0.54
7:I:1621:IMT:O	8:I:1622:PYB:CB	2.55	0.54
4:C:820[A]:ARG:HG3	5:D:1321:ALA:CB	2.38	0.54
4:C:820[B]:ARG:O	5:D:1318:TYR:HA	2.08	0.53
4:G:1102:ILE:HG23	5:H:1458:ILE:HD13	1.90	0.53
1:I:1:DA:H2''	1:I:2:DT:C7	2.38	0.53
1:I:116:DC:H4'	8:I:1628:PYB:CB	2.38	0.53
11:I:1611:DIB:HE11	1:J:265:DT:H1'	1.91	0.53
1:J:267:DG:H5''	5:D:1237:TYR:OH	2.09	0.53
1:I:3:DC:H5	1:J:290:DG:H22	1.55	0.53
1:J:174:DA:H2''	1:J:175:DA:H5'	1.89	0.53
1:I:113:DA:H2	8:I:1624:PYB:HB1	1.74	0.52
1:I:138:DG:H2''	1:I:139:DA:OP2	2.10	0.52
5:D:1273:GLU:HG3	5:D:1298[A]:LEU:CD1	2.38	0.52
1:J:233:DG:H2'	14:J:3886:HOH:O	2.07	0.52

*Continued on next page...*

*Continued from previous page...*

Atom-1	Atom-2	Interatomic distance (Å)	Clash overlap (Å)
3:B:102:GLY:HA2	14:B:3269:HOH:O	2.10	0.52
14:D:3313:HOH:O	3:F:291:LYS:HE2	2.08	0.52
8:I:1622:PYB:HD2	8:I:1628:PYB:HD2	1.92	0.52
5:D:1269:ARG:HD3	14:D:3718:HOH:O	2.09	0.52
3:F:240:ARG:CD	14:F:3864:HOH:O	2.56	0.52
1:I:127:DA:H1'	1:I:128:DT:H5'	1.92	0.52
5:D:1273:GLU:HG3	5:D:1298[A]:LEU:HD21	1.92	0.52
7:I:1621:IMT:CA	1:J:178:DT:O4'	2.58	0.51
1:J:203:DA:H4'	14:J:3344:HOH:O	2.09	0.51
1:J:283:DG:H2''	1:J:284:DG:C8	2.44	0.51
4:G:1031:HIS:CD2	4:G:1048:PRO:HG3	2.46	0.51
1:J:149:DC:H3'	14:J:3559:HOH:O	2.09	0.51
5:H:1427:ARG:O	5:H:1428:LYS:HB3	2.09	0.51
1:J:184:DT:H2''	1:J:185:DG:N7	2.26	0.51
1:J:226:DT:H2''	1:J:227:DG:C8	2.45	0.51
4:G:1020:ARG:O	5:H:1517:LYS:HG2	2.11	0.51
1:I:61:DA:OP1	14:I:3828:HOH:O	2.19	0.51
9:I:1625:ABU:CD	12:J:1700:OGG:OM	2.59	0.51
1:J:182:DT:H2''	1:J:183:DT:OP2	2.11	0.51
2:E:679:LYS:HG3	3:F:274:GLU:OE2	2.11	0.51
8:I:1604:PYB:CD	14:I:3243:HOH:O	2.58	0.51
1:I:113:DA:C1'	9:I:1625:ABU:CG	2.89	0.51
4:C:892:GLU:OE1	5:D:1302:GLU:HB3	2.11	0.51
3:F:216:LYS:HE3	3:F:219:ARG:NH2	2.25	0.51
1:I:28:DA:H2''	1:I:29:DA:C5'	2.41	0.50
9:I:1605:ABU:OXT	9:I:1605:ABU:CD	2.58	0.50
1:J:225:DC:H2''	1:J:226:DT:H71	1.93	0.50
1:J:264:DT:H2''	1:J:265:DT:H71	1.93	0.50
1:J:288:DT:H2''	1:J:289:DT:C5'	2.41	0.50
2:A:468:GLN:HG2	2:A:472:ARG:HE	1.76	0.50
4:G:1020:ARG:HH11	4:G:1020:ARG:HG2	1.76	0.50
4:G:1034:LEU:O	4:G:1039:TYR:HD1	1.94	0.50
1:I:126:DA:H2''	1:I:127:DA:OP2	2.10	0.50
3:B:23:ARG:HH21	3:B:28:GLY:HA2	1.77	0.50
2:E:728:ARG:NH2	2:E:734:ARG:HE	2.08	0.50
11:I:1611:DIB:HE11	1:J:266:DT:H5'	1.93	0.50
4:G:1116:LEU:HB3	4:G:1117:PRO:HD2	1.94	0.50
5:H:1426:ARG:CG	5:H:1426:ARG:NH1	2.74	0.50
1:J:249:DG:H5''	5:H:1428:LYS:N	2.27	0.50
8:I:1602:PYB:O	7:I:1603:IMT:HB	2.11	0.50
8:I:1606:PYB:O	8:I:1606:PYB:HD1	2.12	0.50

*Continued on next page...*

*Continued from previous page...*

Atom-1	Atom-2	Interatomic distance (Å)	Clash overlap (Å)
3:B:95[B]:ARG:HG2	3:B:95[B]:ARG:HH11	1.77	0.49
1:J:152:DT:H2''	1:J:153:DA:C8	2.47	0.49
4:C:817:ARG:HH12	4:C:831:HIS:CD2	2.20	0.49
1:J:170:DA:H2''	1:J:171:DC:OP2	2.13	0.49
1:I:113:DA:H1'	9:I:1625:ABU:CG	2.43	0.49
8:I:1629:PYB:HD1	8:I:1629:PYB:O	2.12	0.49
1:J:149:DC:H2''	1:J:150:DA:O5'	2.12	0.49
2:A:492:LEU:HD13	3:B:86:VAL:CG1	2.42	0.49
4:C:820[A]:ARG:CG	5:D:1321:ALA:HB3	2.43	0.49
1:I:48:DT:H2'	1:I:49:DC:C6	2.48	0.49
1:J:285:DA:H2''	1:J:286:DT:OP2	2.13	0.49
4:C:877:ARG:HD2	14:C:3179:HOH:O	2.12	0.49
4:C:902:ILE:HG23	5:D:1258:ILE:HD13	1.95	0.49
3:F:240:ARG:HD3	14:F:3864:HOH:O	2.12	0.48
1:I:113:DA:N3	9:I:1625:ABU:CG	2.76	0.48
1:J:248:DA:H2''	1:J:249:DG:N7	2.27	0.48
2:A:509:LEU:HB3	14:A:3858:HOH:O	2.13	0.48
3:F:259:LYS:O	3:F:263:GLU:HG3	2.14	0.48
2:A:492:LEU:HD13	3:B:86:VAL:HG13	1.96	0.48
2:A:506:ASP:OD1	2:E:729[B]:ARG:NH1	2.47	0.48
5:D:1287:THR:H	5:D:1290:GLU:HG2	1.78	0.48
1:I:34:DT:H4'	1:I:34:DT:OP1	2.13	0.48
1:J:264:DT:H2''	1:J:265:DT:C5	2.48	0.48
4:C:817:ARG:HH22	4:C:831:HIS:CD2	2.32	0.48
1:I:34:DT:H2'	1:I:35:DA:C8	2.49	0.48
1:J:249:DG:H5''	5:H:1428:LYS:HA	1.94	0.48
8:I:1609:PYB:HD1	8:I:1609:PYB:O	2.13	0.48
5:D:1243:LYS:HE2	5:D:1243:LYS:HA	1.95	0.48
1:I:10:DC:H2''	1:I:11:DA:N7	2.28	0.48
1:I:89:DC:H2''	1:I:90:DT:C7	2.44	0.48
9:I:1605:ABU:CB	12:J:1700:OGG:HD1	2.44	0.48
1:I:25:DC:C1'	1:I:26:DC:H5'	2.43	0.47
4:G:1015:LYS:HG3	4:G:1019:SER:OG	2.14	0.47
4:C:817:ARG:NH1	4:C:831:HIS:HD2	2.06	0.47
4:C:820[B]:ARG:HG2	4:C:820[B]:ARG:NH1	2.11	0.47
2:A:439:HIS:HE1	2:A:441:TYR:CD1	2.32	0.47
5:D:1273:GLU:CG	5:D:1298[A]:LEU:HD21	2.44	0.47
4:G:1035:ARG:HH11	4:G:1035:ARG:CG	2.25	0.47
1:I:6:DT:H2''	1:I:7:DA:OP2	2.15	0.47
1:J:272:DA:H1'	1:J:273:DA:C8	2.49	0.47
2:A:528:ARG:CB	2:A:534:ARG:HG3	2.44	0.47

*Continued on next page...*

*Continued from previous page...*

Atom-1	Atom-2	Interatomic distance (Å)	Clash overlap (Å)
3:B:30:THR:HB	3:B:32:PRO:HD2	1.96	0.47
2:E:669:ARG:NH1	14:E:3173:HOH:O	2.45	0.47
3:F:230:THR:HB	3:F:232:PRO:HD2	1.96	0.47
1:J:222:DC:H2''	1:J:223:DC:C5	2.50	0.47
1:I:3:DC:H5	1:J:290:DG:N2	2.13	0.47
1:J:230:DC:H2''	1:J:231:DA:C8	2.50	0.47
4:G:1017:ARG:HH12	4:G:1031:HIS:HD2	1.55	0.47
1:I:92:DT:H2''	14:I:3889:HOH:O	2.14	0.46
1:I:108:DC:H2''	1:I:109:DA:N7	2.30	0.46
1:J:227:DG:H5'	3:B:47:SER:HA	1.97	0.46
5:D:1315:VAL:O	5:D:1319:THR:HG23	2.14	0.46
1:I:120:DT:H2''	1:I:121:DG:C8	2.50	0.46
2:A:528:ARG:HB3	2:A:534:ARG:HG3	1.97	0.46
3:F:231:LYS:O	3:F:235[B]:ARG:HG3	2.15	0.46
1:I:104:DT:OP1	5:D:1227:ARG:HB3	2.16	0.46
2:E:665:LEU:HB3	2:E:666:PRO:HD3	1.96	0.46
8:I:1622:PYB:O	7:I:1623:IMT:HB	2.15	0.46
3:B:102:GLY:CA	14:B:3269:HOH:O	2.63	0.46
1:I:21:DT:H2''	1:I:22:DC:H5'	1.94	0.46
8:I:1602:PYB:O	8:I:1602:PYB:HD1	2.16	0.46
1:J:182:DT:H1'	1:J:183:DT:H5'	1.97	0.46
1:J:288:DT:H1'	1:J:289:DT:H5''	1.98	0.46
2:A:479:LYS:HD2	3:B:74:GLU:HG2	1.98	0.46
4:C:837:GLY:HA3	4:C:839:TYR:CE1	2.51	0.46
4:G:1099:ARG:HD3	14:G:3272:HOH:O	2.15	0.46
1:J:249:DG:H5''	5:H:1428:LYS:CA	2.46	0.46
1:I:41:DA:H2''	1:I:42:DA:O5'	2.16	0.45
1:I:112:DT:P	4:G:1035:ARG:HH22	2.39	0.45
8:I:1624:PYB:C	9:I:1625:ABU:OXT	2.64	0.45
1:J:192:DG:H5''	5:D:1224:LYS:HB3	1.98	0.45
1:J:237:DT:H4'	2:A:463:ARG:NH2	2.31	0.45
1:I:22:DC:N4	1:J:271:DG:N1	2.60	0.45
1:I:114:DC:C2	8:I:1626:PYB:HB1	2.46	0.45
8:I:1607:PYB:N	1:J:261:DA:O4'	2.49	0.45
1:J:152:DT:H2''	1:J:153:DA:H8	1.81	0.45
1:J:227:DG:H5'	3:B:46:ILE:O	2.16	0.45
1:I:117:DT:C6	1:I:118:DT:H72	2.50	0.45
8:I:1629:PYB:HB1	1:J:177:DG:N2	2.31	0.45
1:J:191:DT:H1'	1:J:192:DG:C8	2.51	0.45
14:D:3313:HOH:O	3:F:291:LYS:CE	2.64	0.45
1:J:174:DA:H2''	1:J:175:DA:H5''	1.97	0.45

*Continued on next page...*



*Continued from previous page...*

Atom-1	Atom-2	Interatomic distance (Å)	Clash overlap (Å)
3:F:231:LYS:HG2	3:F:235[B]:ARG:NH1	2.26	0.45
1:I:22:DC:H42	1:J:271:DG:H1	1.60	0.45
11:I:1611:DIB:ND	1:J:265:DT:O2	2.49	0.45
1:J:154:DT:H2''	1:J:155:DC:H5'	1.99	0.45
1:I:1:DA:C2'	1:I:2:DT:H72	2.42	0.45
2:A:465:LEU:HB3	2:A:466:PRO:HD3	1.97	0.45
2:A:521:PRO:HD2	13:A:2017:CL:CL	2.54	0.45
5:H:1428:LYS:O	5:H:1428:LYS:HG3	2.17	0.45
1:J:225:DC:H2''	1:J:226:DT:C7	2.48	0.44
1:J:229:DA:N3	2:A:440:ARG:NH2	2.65	0.44
1:J:258:DT:H4'	1:J:258:DT:OP1	2.16	0.44
1:I:112:DT:H2''	1:I:113:DA:C8	2.53	0.44
1:J:239:DT:H2''	1:J:240:DG:C8	2.53	0.44
3:F:235[A]:ARG:HD3	3:F:251:TYR:OH	2.17	0.44
1:I:23:DT:H2''	1:I:24:DA:O5'	2.17	0.44
1:I:93:DT:H1'	1:I:94:DG:H5''	1.98	0.44
1:J:222:DC:H2''	1:J:223:DC:C6	2.52	0.44
4:C:892:GLU:CA	14:C:3436:HOH:O	2.65	0.44
4:G:1031:HIS:CE1	4:G:1035:ARG:HH21	2.33	0.44
2:E:669:ARG:HD2	3:F:225:ASN:OD1	2.17	0.44
8:I:1622:PYB:O	8:I:1622:PYB:HD1	2.17	0.44
5:H:1443:LYS:HA	5:H:1443:LYS:HD3	1.69	0.44
1:J:266:DT:H2''	1:J:267:DG:N7	2.33	0.44
1:J:233:DG:H1'	1:J:234:DC:O5'	2.18	0.43
4:G:1079:ILE:HB	4:G:1080:PRO:HD2	1.99	0.43
1:I:3:DC:H5	1:J:290:DG:C2	2.36	0.43
1:I:36:DT:H5''	14:I:3243:HOH:O	2.17	0.43
11:I:1631:DIB:HB1	1:J:176:DA:H1'	2.00	0.43
2:A:476:GLN:NE2	2:A:480:THR:HG22	2.33	0.43
2:E:729[B]:ARG:C	2:E:729[B]:ARG:CD	2.84	0.43
4:G:1044:GLY:HA3	13:G:2016:CL:CL	2.56	0.43
11:I:1611:DIB:CE1	1:J:265:DT:O2	2.66	0.43
2:A:439:HIS:CD2	14:A:3856:HOH:O	2.71	0.43
3:B:23:ARG:NH2	3:B:28:GLY:HA2	2.33	0.43
1:I:6:DT:H2''	1:I:7:DA:C8	2.53	0.43
1:I:28:DA:C5'	5:D:1227:ARG:NH2	2.77	0.43
5:D:1273:GLU:HG2	14:D:3250:HOH:O	2.18	0.43
4:G:1079:ILE:HB	4:G:1080:PRO:CD	2.48	0.43
1:J:269:DT:OP1	5:D:1231:LYS:HG2	2.19	0.43
8:I:1622:PYB:O	7:I:1623:IMT:CB	2.67	0.43
5:H:1445:VAL:HG12	5:H:1446:HIS:CD2	2.53	0.43

*Continued on next page...*

*Continued from previous page...*

Atom-1	Atom-2	Interatomic distance (Å)	Clash overlap (Å)
1:I:81:DG:P	3:F:235[A]:ARG:HH12	2.42	0.43
1:J:250:DT:OP1	5:H:1427:ARG:HB2	2.19	0.43
1:J:288:DT:H2''	1:J:289:DT:H5'	2.01	0.43
5:H:1426:ARG:O	5:H:1427:ARG:HB2	2.18	0.43
11:I:1631:DIB:HA2	11:I:1631:DIB:CE1	2.47	0.42
4:C:820[B]:ARG:CG	4:C:820[B]:ARG:NH1	2.71	0.42
5:D:1273:GLU:HG3	5:D:1298[A]:LEU:CD2	2.49	0.42
1:I:23:DT:OP2	1:I:23:DT:H6	2.03	0.42
1:I:93:DT:C6	14:I:3889:HOH:O	2.52	0.42
8:I:1602:PYB:O	7:I:1603:IMT:CB	2.64	0.42
8:I:1626:PYB:O	8:I:1626:PYB:HD1	2.18	0.42
2:E:728:ARG:HH22	2:E:734:ARG:HE	1.67	0.42
4:G:1020:ARG:HD3	5:H:1522:LYS:OXT	2.19	0.42
2:A:458:THR:CG2	4:G:1081:ARG:HG2	2.49	0.42
5:D:1270:ILE:HA	5:D:1298[A]:LEU:CD1	2.49	0.42
12:J:1700:OGG:CD	12:J:1700:OGG:CF	2.93	0.42
8:I:1627:PYB:O	8:I:1628:PYB:CB	2.53	0.42
2:E:660:LEU:HD12	2:E:664[A]:LYS:CE	2.35	0.42
4:G:1035:ARG:H	4:G:1035:ARG:HG3	1.62	0.42
1:I:30:DA:H1'	11:I:1611:DIB:HB1	2.02	0.41
1:J:151:DA:H1'	1:J:152:DT:H5''	2.01	0.41
2:E:659:GLU:OE1	2:E:659:GLU:N	2.51	0.41
4:C:835:ARG:HH11	4:C:835:ARG:HG2	1.85	0.41
1:I:48:DT:H2''	1:I:49:DC:O4'	2.20	0.41
1:I:114:DC:OP1	1:I:114:DC:H4'	2.20	0.41
1:J:186:DG:H1'	1:J:187:DA:C8	2.55	0.41
1:I:7:DA:H5'	2:E:641:TYR:OH	2.20	0.41
1:J:154:DT:P	2:A:449:ARG:HD2	2.60	0.41
1:I:93:DT:C2'	1:I:94:DG:C5'	2.97	0.41
1:J:271:DG:C6	1:J:272:DA:N6	2.88	0.41
4:C:813:LYS:O	4:C:813:LYS:CD	2.67	0.41
2:E:687:SER:OG	3:F:283:ALA:HB2	2.20	0.41
1:I:3:DC:O2	1:I:3:DC:C2'	2.67	0.41
1:J:246:DG:H5'	3:B:79:LYS:HD2	2.03	0.41
8:I:1624:PYB:C	9:I:1625:ABU:C	2.90	0.41
1:J:195:DC:H1'	1:J:196:DC:C5	2.56	0.41
1:I:25:DC:H4'	1:I:26:DC:OP1	2.20	0.41
1:J:155:DC:H5'	1:J:155:DC:H6	1.86	0.41
1:J:174:DA:C2'	1:J:175:DA:H5''	2.51	0.41
1:J:258:DT:H5'	4:C:835:ARG:NH2	2.36	0.41
2:A:535:ALA:HB1	14:A:3779:HOH:O	2.20	0.41

*Continued on next page...*

Continued from previous page...

Atom-1	Atom-2	Interatomic distance (Å)	Clash overlap (Å)
1:I:3:DC:H5'	1:I:3:DC:O2	2.22	0.40
1:I:9:DC:H2''	1:I:10:DC:O5'	2.21	0.40
8:I:1626:PYB:O	8:I:1627:PYB:CB	2.55	0.40
2:E:663:ARG:CZ	14:E:3823:HOH:O	2.67	0.40
1:I:144:DG:H1	1:J:149:DC:N4	2.12	0.40
11:I:1611:DIB:HE12	11:I:1611:DIB:CA	2.42	0.40
1:J:268:DG:H2''	1:J:269:DT:O5'	2.22	0.40
2:A:439:HIS:CE1	2:A:441:TYR:CE1	3.09	0.40
2:A:526:LEU:HD22	2:E:713:HIS:CG	2.57	0.40
1:I:28:DA:C5'	5:D:1227:ARG:HH21	2.31	0.40

There are no symmetry-related clashes.

## 5.3 Torsion angles [i](#)

### 5.3.1 Protein backbone [i](#)

In the following table, the Percentiles column shows the percent Ramachandran outliers of the chain as a percentile score with respect to all X-ray entries followed by that with respect to entries of similar resolution.

The Analysed column shows the number of residues for which the backbone conformation was analysed, and the total number of residues.

Mol	Chain	Analysed	Favoured	Allowed	Outliers	Percentiles	
2	A	97/135 (72%)	97 (100%)	0	0	100	100
2	E	102/135 (76%)	101 (99%)	0	1 (1%)	15	6
3	B	81/102 (79%)	78 (96%)	1 (1%)	2 (2%)	5	1
3	F	88/102 (86%)	82 (93%)	6 (7%)	0	100	100
4	C	106/119 (89%)	102 (96%)	4 (4%)	0	100	100
4	G	105/119 (88%)	103 (98%)	2 (2%)	0	100	100
5	D	102/122 (84%)	97 (95%)	1 (1%)	4 (4%)	3	0
5	H	98/122 (80%)	92 (94%)	3 (3%)	3 (3%)	4	0
All	All	779/956 (82%)	752 (96%)	17 (2%)	10 (1%)	12	4

All (10) Ramachandran outliers are listed below:

Mol	Chain	Res	Type
3	B	23	ARG
3	B	25	ASN
5	D	1224	LYS
5	D	1227	ARG
5	D	1301	GLY
5	H	1427	ARG
5	H	1501	GLY
5	H	1521	ALA
5	D	1225	LYS
2	E	638	PRO

### 5.3.2 Protein sidechains [i](#)

In the following table, the Percentiles column shows the percent sidechain outliers of the chain as a percentile score with respect to all X-ray entries followed by that with respect to entries of similar resolution.

The Analysed column shows the number of residues for which the sidechain conformation was analysed, and the total number of residues.

Mol	Chain	Analysed	Rotameric	Outliers	Percentiles	
2	A	86/110 (78%)	80 (93%)	6 (7%)	15	7
2	E	91/110 (83%)	90 (99%)	1 (1%)	73	73
3	B	68/78 (87%)	64 (94%)	4 (6%)	19	11
3	F	74/78 (95%)	73 (99%)	1 (1%)	67	65
4	C	85/92 (92%)	82 (96%)	3 (4%)	36	29
4	G	85/92 (92%)	82 (96%)	3 (4%)	36	29
5	D	89/102 (87%)	89 (100%)	0	100	100
5	H	86/102 (84%)	82 (95%)	4 (5%)	26	18
All	All	664/764 (87%)	642 (97%)	22 (3%)	40	31

All (22) residues with a non-rotameric sidechain are listed below:

Mol	Chain	Res	Type
2	A	448	LEU
2	A	459	GLU
2	A	463	ARG
2	A	490[A]	MET
2	A	490[B]	MET
2	A	492	LEU

*Continued on next page...*

*Continued from previous page...*

Mol	Chain	Res	Type
3	B	22	LEU
3	B	47	SER
3	B	95[A]	ARG
3	B	95[B]	ARG
4	C	813	LYS
4	C	829	ARG
4	C	876	THR
2	E	638	PRO
3	F	216	LYS
4	G	1035	ARG
4	G	1081	ARG
4	G	1119	LYS
5	H	1426	ARG
5	H	1430	ARG
5	H	1433	SER
5	H	1522	LYS

Sometimes sidechains can be flipped to improve hydrogen bonding and reduce clashes. All (5) such sidechains are listed below:

Mol	Chain	Res	Type
2	A	439	HIS
4	C	831	HIS
5	D	1279	HIS
4	G	1031	HIS
5	H	1492	GLN

### 5.3.3 RNA [i](#)

There are no RNA molecules in this entry.

### 5.4 Non-standard residues in protein, DNA, RNA chains [i](#)

There are no non-standard protein/DNA/RNA residues in this entry.

### 5.5 Carbohydrates [i](#)

There are no monosaccharides in this entry.

## 5.6 Ligand geometry

Of 41 ligands modelled in this entry, 18 are monoatomic - leaving 23 for Mogul analysis.

In the following table, the Counts columns list the number of bonds (or angles) for which Mogul statistics could be retrieved, the number of bonds (or angles) that are observed in the model and the number of bonds (or angles) that are defined in the Chemical Component Dictionary. The Link column lists molecule types, if any, to which the group is linked. The Z score for a bond length (or angle) is the number of standard deviations the observed value is removed from the expected value. A bond length (or angle) with  $|Z| > 2$  is considered an outlier worth inspection. RMSZ is the root-mean-square of all Z scores of the bond lengths (or angles).

Mol	Type	Chain	Res	Link	Bond lengths			Bond angles		
					Counts	RMSZ	# Z  > 2	Counts	RMSZ	# Z  > 2
8	PYB	I	1609	-	7,9,10	1.03	1 (14%)	3,12,14	4.17	2 (66%)
7	IMT	I	1601	-	7,8,10	0.97	1 (14%)	5,10,14	2.30	3 (60%)
8	PYB	I	1602	-	7,9,10	1.25	2 (28%)	3,12,14	3.33	2 (66%)
7	IMT	I	1603	-	5,9,10	1.05	0	5,12,14	2.24	2 (40%)
8	PYB	I	1626	-	7,9,10	1.92	3 (42%)	3,12,14	3.04	2 (66%)
12	OGG	J	1700	-	11,11,11	6.61	8 (72%)	12,12,12	2.30	3 (25%)
8	PYB	I	1627	-	7,9,10	1.08	0	3,12,14	4.00	2 (66%)
8	PYB	I	1606	-	7,9,10	3.78	3 (42%)	3,12,14	4.28	2 (66%)
8	PYB	I	1604	-	7,9,10	1.02	0	3,12,14	3.63	2 (66%)
9	ABU	I	1625	-	5,5,6	1.50	1 (20%)	4,4,6	1.90	1 (25%)
8	PYB	I	1629	-	7,9,10	1.05	1 (14%)	3,12,14	4.00	2 (66%)
7	IMT	I	1623	-	5,9,10	0.78	0	5,12,14	2.15	2 (40%)
7	IMT	I	1621	-	7,8,10	0.95	1 (14%)	5,10,14	2.28	3 (60%)
9	ABU	I	1605	-	5,5,6	2.47	3 (60%)	4,4,6	1.37	1 (25%)
10	BAL	I	1610	-	4,4,5	0.57	0	3,3,5	1.65	1 (33%)
11	DIB	I	1611	-	6,6,6	0.63	0	6,6,6	0.88	0
8	PYB	I	1607	-	7,9,10	1.07	0	3,12,14	4.02	2 (66%)
11	DIB	I	1631	-	6,6,6	0.69	0	6,6,6	0.83	0
8	PYB	I	1624	-	7,9,10	1.05	0	3,12,14	3.31	2 (66%)
8	PYB	I	1622	-	7,9,10	1.32	2 (28%)	3,12,14	3.43	2 (66%)
10	BAL	I	1630	-	4,4,5	0.47	0	3,3,5	0.82	0
8	PYB	I	1608	-	7,9,10	1.10	1 (14%)	3,12,14	4.89	2 (66%)
8	PYB	I	1628	-	7,9,10	1.18	1 (14%)	3,12,14	4.52	2 (66%)

In the following table, the Chirals column lists the number of chiral outliers, the number of chiral centers analysed, the number of these observed in the model and the number defined in the Chemical Component Dictionary. Similar counts are reported in the Torsion and Rings columns.

'-' means no outliers of that kind were identified.

Mol	Type	Chain	Res	Link	Chirals	Torsions	Rings
8	PYB	I	1609	-	-	0/0/2/4	0/1/1/1
7	IMT	I	1601	-	-	0/0/2/4	0/1/1/1
8	PYB	I	1602	-	-	0/0/2/4	0/1/1/1
7	IMT	I	1603	-	-	0/0/2/4	0/1/1/1
8	PYB	I	1626	-	-	0/0/2/4	0/1/1/1
12	OGG	J	1700	-	-	5/9/9/9	-
8	PYB	I	1627	-	-	0/0/2/4	0/1/1/1
8	PYB	I	1606	-	-	0/0/2/4	0/1/1/1
8	PYB	I	1604	-	-	0/0/2/4	0/1/1/1
9	ABU	I	1625	-	-	3/3/3/4	-
8	PYB	I	1629	-	-	0/0/2/4	0/1/1/1
7	IMT	I	1623	-	-	0/0/2/4	0/1/1/1
7	IMT	I	1621	-	-	0/0/2/4	0/1/1/1
9	ABU	I	1605	-	-	3/3/3/4	-
10	BAL	I	1610	-	-	0/1/2/3	-
11	DIB	I	1611	-	-	0/4/4/4	-
8	PYB	I	1607	-	-	0/0/2/4	0/1/1/1
11	DIB	I	1631	-	-	0/4/4/4	-
8	PYB	I	1624	-	-	0/0/2/4	0/1/1/1
8	PYB	I	1622	-	-	0/0/2/4	0/1/1/1
10	BAL	I	1630	-	-	0/1/2/3	-
8	PYB	I	1608	-	-	0/0/2/4	0/1/1/1
8	PYB	I	1628	-	-	0/0/2/4	0/1/1/1

All (28) bond length outliers are listed below:

Mol	Chain	Res	Type	Atoms	Z	Observed(Å)	Ideal(Å)
12	J	1700	OGG	OE-CD	15.01	1.80	1.42
12	J	1700	OGG	OH-CI	11.25	1.70	1.42
8	I	1606	PYB	CB-CA	8.28	1.47	1.38
12	J	1700	OGG	CD-CC	5.88	1.62	1.50
12	J	1700	OGG	OH-CG	5.49	1.65	1.42
12	J	1700	OGG	OE-CF	4.68	1.62	1.42
8	I	1606	PYB	CB1-CA	4.52	1.43	1.39
9	I	1605	ABU	OXT-C	-3.85	1.22	1.42
12	J	1700	OGG	CG-CF	3.47	1.66	1.49
12	J	1700	OGG	OL-CC	-3.39	1.13	1.24
12	J	1700	OGG	CJ-NK	3.30	1.43	1.32
8	I	1626	PYB	CB-CA	2.95	1.41	1.38
9	I	1605	ABU	CG-CB	2.68	1.66	1.51
9	I	1625	ABU	OXT-C	-2.58	1.28	1.42

*Continued on next page...*

*Continued from previous page...*

Mol	Chain	Res	Type	Atoms	Z	Observed(Å)	Ideal(Å)
8	I	1626	PYB	CB1-CA	2.54	1.41	1.39
9	I	1605	ABU	CG-C	2.53	1.65	1.50
8	I	1626	PYB	CG1-NG2	2.52	1.41	1.36
8	I	1622	PYB	CG1-NG2	2.40	1.41	1.36
8	I	1602	PYB	CB-CA	2.37	1.40	1.38
8	I	1628	PYB	CG1-NG2	2.33	1.41	1.36
8	I	1629	PYB	CG1-NG2	2.30	1.41	1.36
8	I	1608	PYB	CG1-NG2	2.29	1.41	1.36
8	I	1606	PYB	CB1-CG1	2.28	1.42	1.39
8	I	1622	PYB	CB-CA	2.27	1.40	1.38
8	I	1609	PYB	CG1-NG2	2.26	1.41	1.36
8	I	1602	PYB	CG1-NG2	2.10	1.40	1.36
7	I	1601	IMT	CB-NG2	2.07	1.41	1.37
7	I	1621	IMT	CB-NG2	2.04	1.41	1.37

All (40) bond angle outliers are listed below:

Mol	Chain	Res	Type	Atoms	Z	Observed(°)	Ideal(°)
8	I	1608	PYB	CB1-CA-CB	6.67	109.31	106.05
8	I	1609	PYB	CB1-CA-CB	5.84	108.91	106.05
8	I	1628	PYB	CB1-CA-CB	5.82	108.90	106.05
8	I	1606	PYB	CB1-CA-CB	-5.72	103.25	106.05
8	I	1629	PYB	CB1-CA-CB	5.27	108.63	106.05
8	I	1607	PYB	CB1-CA-CB	5.20	108.59	106.05
8	I	1628	PYB	O-C-CG1	-5.13	116.89	124.17
8	I	1608	PYB	O-C-CG1	-5.13	116.90	124.17
12	J	1700	OGG	CD-CC-NB	4.97	132.24	117.67
8	I	1627	PYB	O-C-CG1	-4.95	117.16	124.17
8	I	1627	PYB	CB1-CA-CB	4.76	108.38	106.05
8	I	1606	PYB	O-C-CG1	-4.70	117.51	124.17
8	I	1607	PYB	O-C-CG1	-4.56	117.71	124.17
8	I	1604	PYB	CB1-CA-CB	4.46	108.23	106.05
8	I	1626	PYB	O-C-CG1	-4.33	118.03	124.17
8	I	1629	PYB	O-C-CG1	-4.32	118.05	124.17
8	I	1602	PYB	CB1-CA-CB	4.31	108.16	106.05
8	I	1622	PYB	CB1-CA-CB	4.30	108.15	106.05
8	I	1604	PYB	O-C-CG1	-4.20	118.22	124.17
8	I	1624	PYB	O-C-CG1	-4.15	118.29	124.17
8	I	1609	PYB	O-C-CG1	-4.10	118.36	124.17
8	I	1622	PYB	O-C-CG1	-3.99	118.52	124.17
8	I	1624	PYB	CB1-CA-CB	3.80	107.91	106.05
8	I	1602	PYB	O-C-CG1	-3.73	118.88	124.17

*Continued on next page...*



Continued from previous page...

Mol	Chain	Res	Type	Atoms	Z	Observed(°)	Ideal(°)
7	I	1603	IMT	CD-NG2-CG1	3.68	131.69	126.50
12	J	1700	OGG	OL-CC-CD	-3.61	112.04	119.10
7	I	1623	IMT	CD-NG2-CG1	3.57	131.52	126.50
7	I	1603	IMT	CB-NG2-CG1	-3.19	104.95	108.47
7	I	1601	IMT	CD-NG2-CG1	3.18	130.98	126.50
7	I	1621	IMT	CD-NG2-CG1	3.17	130.96	126.50
7	I	1601	IMT	CA-NB1-CG1	3.10	108.43	104.34
7	I	1621	IMT	CA-NB1-CG1	3.09	108.42	104.34
7	I	1623	IMT	CB-NG2-CG1	-3.02	105.14	108.47
8	I	1626	PYB	CB1-CA-CB	2.97	107.50	106.05
12	J	1700	OGG	OL-CC-NB	-2.59	115.42	122.50
9	I	1625	ABU	CB-CG-C	2.54	130.63	114.02
10	I	1610	BAL	CB-CA-C	-2.47	107.75	111.42
7	I	1601	IMT	CB-NG2-CG1	-2.43	105.59	108.45
7	I	1621	IMT	CB-NG2-CG1	-2.38	105.65	108.45
9	I	1605	ABU	CG-CB-CD	-2.06	99.20	113.77

There are no chirality outliers.

All (11) torsion outliers are listed below:

Mol	Chain	Res	Type	Atoms
9	I	1605	ABU	CD-CB-CG-C
9	I	1625	ABU	CD-CB-CG-C
12	J	1700	OGG	OH-CI-CJ-NK
12	J	1700	OGG	OE-CF-CG-OH
9	I	1605	ABU	OXT-C-CG-CB
9	I	1625	ABU	OXT-C-CG-CB
12	J	1700	OGG	OH-CI-CJ-OM
9	I	1625	ABU	CG-CB-CD-N
12	J	1700	OGG	CG-CF-OE-CD
9	I	1605	ABU	CG-CB-CD-N
12	J	1700	OGG	CF-CG-OH-CI

There are no ring outliers.

21 monomers are involved in 94 short contacts:

Mol	Chain	Res	Type	Clashes	Symm-Clashes
8	I	1609	PYB	3	0
7	I	1601	IMT	4	0
8	I	1602	PYB	5	0
7	I	1603	IMT	5	0

Continued on next page...

*Continued from previous page...*

Mol	Chain	Res	Type	Clashes	Symm-Clashes
8	I	1626	PYB	8	0
12	J	1700	OGG	10	0
8	I	1627	PYB	5	0
8	I	1606	PYB	4	0
8	I	1604	PYB	7	0
9	I	1625	ABU	9	0
8	I	1629	PYB	6	0
7	I	1623	IMT	5	0
7	I	1621	IMT	5	0
9	I	1605	ABU	6	0
11	I	1611	DIB	11	0
8	I	1607	PYB	6	0
11	I	1631	DIB	5	0
8	I	1624	PYB	6	0
8	I	1622	PYB	6	0
8	I	1608	PYB	5	0
8	I	1628	PYB	7	0

## 5.7 Other polymers [i](#)

There are no such residues in this entry.

## 5.8 Polymer linkage issues [i](#)

There are no chain breaks in this entry.

## 6 Fit of model and data [i](#)

### 6.1 Protein, DNA and RNA chains [i](#)

In the following table, the column labelled ‘#RSRZ > 2’ contains the number (and percentage) of RSRZ outliers, followed by percent RSRZ outliers for the chain as percentile scores relative to all X-ray entries and entries of similar resolution. The OWAB column contains the minimum, median, 95<sup>th</sup> percentile and maximum values of the occupancy-weighted average B-factor per residue. The column labelled ‘Q < 0.9’ lists the number of (and percentage) of residues with an average occupancy less than 0.9.

Mol	Chain	Analysed	<RSRZ>	#RSRZ>2	OWAB(Å <sup>2</sup> )	Q<0.9
1	I	146/146 (100%)	0.35	3 (2%) 63 67	42, 97, 137, 157	0
1	J	146/146 (100%)	0.28	4 (2%) 54 59	46, 100, 145, 162	0
2	A	98/135 (72%)	0.62	3 (3%) 49 53	31, 44, 71, 93	0
2	E	99/135 (73%)	0.57	5 (5%) 28 30	26, 36, 61, 87	0
3	B	81/102 (79%)	0.60	4 (4%) 29 31	32, 42, 70, 115	0
3	F	88/102 (86%)	0.72	6 (6%) 17 18	26, 37, 81, 132	0
4	C	107/119 (89%)	0.67	5 (4%) 31 33	28, 41, 65, 93	0
4	G	107/119 (89%)	0.83	8 (7%) 14 15	35, 52, 77, 109	0
5	D	101/122 (82%)	0.95	9 (8%) 9 10	30, 43, 112, 138	0
5	H	98/122 (80%)	0.82	11 (11%) 5 5	34, 50, 105, 128	0
All	All	1071/1248 (85%)	0.62	58 (5%) 25 28	26, 50, 126, 162	0

All (58) RSRZ outliers are listed below:

Mol	Chain	Res	Type	RSRZ
4	C	813	LYS	11.2
3	B	102	GLY	10.0
4	C	812	ALA	9.2
2	A	535	ALA	9.1
5	D	1222	ASP	8.6
4	G	1119	LYS	8.3
5	D	1223	GLY	7.7
3	F	302	GLY	6.7
4	G	1013	LYS	6.6
5	H	1522	LYS	5.5
2	E	735	ALA	4.9
5	D	1225	LYS	4.8
3	F	219	ARG	4.7

*Continued on next page...*

*Continued from previous page...*

<b>Mol</b>	<b>Chain</b>	<b>Res</b>	<b>Type</b>	<b>RSRZ</b>
5	D	1321	ALA	4.6
3	F	215	ALA	4.6
5	D	1322	LYS	4.5
1	J	233	DG	4.4
2	E	678[A]	PHE	4.0
1	I	11	DA	4.0
5	H	1427	ARG	3.9
4	G	1014	ALA	3.7
3	F	216	LYS	3.7
3	F	218	HIS	3.6
5	H	1426	ARG	3.4
2	A	439	HIS	3.4
3	B	22	LEU	3.3
2	E	637	LYS	3.2
4	G	1035	ARG	3.2
2	A	534	ARG	3.2
4	G	1041	GLU	3.2
4	G	1118	LYS	3.1
1	J	232	DT	3.0
1	J	234	DC	2.9
2	E	734	ARG	2.9
5	D	1227	ARG	2.9
3	B	23	ARG	2.8
5	H	1430	ARG	2.8
4	C	820[A]	ARG	2.6
5	H	1425	LYS	2.5
5	H	1439	TYR	2.5
5	H	1429	THR	2.5
3	F	217	ARG	2.4
5	D	1229	THR	2.3
5	H	1505	LYS	2.3
5	H	1520	SER	2.3
5	D	1239[A]	TYR	2.2
3	B	24	ASP	2.2
2	E	638	PRO	2.2
4	C	836	LYS	2.2
4	G	1036	LYS	2.2
5	H	1444	GLN	2.1
5	D	1305	LYS	2.1
1	J	231	DA	2.1
5	H	1518	TYR	2.1
4	G	1076	THR	2.1

*Continued on next page...*

*Continued from previous page...*

Mol	Chain	Res	Type	RSRZ
1	I	114	DC	2.0
1	I	119	DT	2.0
4	C	845	ALA	2.0

## 6.2 Non-standard residues in protein, DNA, RNA chains [i](#)

There are no non-standard protein/DNA/RNA residues in this entry.

## 6.3 Carbohydrates [i](#)

There are no monosaccharides in this entry.

## 6.4 Ligands [i](#)

In the following table, the Atoms column lists the number of modelled atoms in the group and the number defined in the chemical component dictionary. The B-factors column lists the minimum, median, 95<sup>th</sup> percentile and maximum values of B factors of atoms in the group. The column labelled 'Q<0.9' lists the number of atoms with occupancy less than 0.9.

Mol	Type	Chain	Res	Atoms	RSCC	RSR	B-factors(Å <sup>2</sup> )	Q<0.9
9	ABU	I	1625	6/7	0.13	0.39	137,139,141,143	0
12	OGG	J	1700	12/12	0.26	0.25	111,119,129,130	0
11	DIB	I	1611	7/7	0.39	0.42	142,142,142,142	0
9	ABU	I	1605	6/7	0.46	0.21	136,138,141,144	0
6	MN	I	2007	1/1	0.59	0.12	89,89,89,89	1
6	MN	I	2009	1/1	0.64	0.19	106,106,106,106	1
10	BAL	I	1630	5/6	0.64	0.39	143,143,143,143	0
8	PYB	I	1626	9/10	0.69	0.22	141,144,146,146	0
6	MN	J	2010	1/1	0.69	0.20	104,104,104,104	1
6	MN	I	2014	1/1	0.70	0.15	107,107,107,107	1
6	MN	J	2011	1/1	0.70	0.18	93,93,93,93	1
8	PYB	I	1604	9/10	0.70	0.27	146,148,148,148	0
11	DIB	I	1631	7/7	0.72	0.56	142,143,143,143	0
6	MN	I	2006	1/1	0.72	0.10	101,101,101,101	1
8	PYB	I	1606	9/10	0.74	0.21	140,143,145,146	0
10	BAL	I	1610	5/6	0.76	0.30	141,142,142,143	0
8	PYB	I	1609	9/10	0.78	0.26	143,144,144,144	0
6	MN	J	2008	1/1	0.78	0.15	109,109,109,109	1
7	IMT	I	1603	9/10	0.78	0.26	148,148,148,148	0
6	MN	J	2013	1/1	0.81	0.09	90,90,90,90	1

*Continued on next page...*

*Continued from previous page...*

Mol	Type	Chain	Res	Atoms	RSCC	RSR	B-factors( $\text{\AA}^2$ )	Q<0.9
8	PYB	I	1624	9/10	0.81	0.23	144,146,146,146	0
7	IMT	I	1621	8/10	0.82	0.28	147,147,148,148	0
6	MN	J	2005	1/1	0.83	0.14	77,77,77,77	0
8	PYB	I	1608	9/10	0.83	0.34	144,144,145,145	0
8	PYB	I	1607	9/10	0.84	0.23	145,145,145,145	0
7	IMT	I	1623	9/10	0.85	0.20	146,146,147,147	0
8	PYB	I	1629	9/10	0.85	0.21	143,144,144,144	0
8	PYB	I	1602	9/10	0.85	0.24	148,148,149,149	0
7	IMT	I	1601	8/10	0.86	0.36	149,149,149,149	0
8	PYB	I	1622	9/10	0.86	0.30	147,147,147,148	0
8	PYB	I	1628	9/10	0.88	0.29	144,144,145,145	0
8	PYB	I	1627	9/10	0.90	0.21	145,145,145,145	0
6	MN	I	2003	1/1	0.94	0.18	83,83,83,83	0
6	MN	J	2002	1/1	0.94	0.11	72,72,72,72	1
6	MN	I	2004	1/1	0.95	0.18	77,77,77,77	1
13	CL	D	2018	1/1	0.95	0.18	50,50,50,50	0
13	CL	G	2016	1/1	0.95	0.17	54,54,54,54	0
6	MN	I	2012	1/1	0.96	0.07	60,60,60,60	1
13	CL	E	2015	1/1	0.97	0.17	48,48,48,48	1
13	CL	A	2017	1/1	0.98	0.15	56,56,56,56	0
6	MN	E	2001	1/1	1.00	0.13	34,34,34,34	0

## 6.5 Other polymers [i](#)

There are no such residues in this entry.